



Is Now Part of



**ON Semiconductor®**

To learn more about ON Semiconductor, please visit our website at  
[www.onsemi.com](http://www.onsemi.com)

Please note: As part of the Fairchild Semiconductor integration, some of the Fairchild orderable part numbers will need to change in order to meet ON Semiconductor's system requirements. Since the ON Semiconductor product management systems do not have the ability to manage part nomenclature that utilizes an underscore (\_), the underscore (\_) in the Fairchild part numbers will be changed to a dash (-). This document may contain device numbers with an underscore (\_). Please check the ON Semiconductor website to verify the updated device numbers. The most current and up-to-date ordering information can be found at [www.onsemi.com](http://www.onsemi.com). Please email any questions regarding the system integration to [Fairchild\\_questions@onsemi.com](mailto:Fairchild_questions@onsemi.com).

ON Semiconductor and the ON Semiconductor logo are trademarks of Semiconductor Components Industries, LLC dba ON Semiconductor or its subsidiaries in the United States and/or other countries. ON Semiconductor owns the rights to a number of patents, trademarks, copyrights, trade secrets, and other intellectual property. A listing of ON Semiconductor's product/patent coverage may be accessed at [www.onsemi.com/site/pdf/Patent-Marking.pdf](http://www.onsemi.com/site/pdf/Patent-Marking.pdf). ON Semiconductor reserves the right to make changes without further notice to any products herein. ON Semiconductor makes no warranty, representation or guarantee regarding the suitability of its products for any particular purpose, nor does ON Semiconductor assume any liability arising out of the application or use of any product or circuit, and specifically disclaims any and all liability, including without limitation special, consequential or incidental damages. Buyer is responsible for its products and applications using ON Semiconductor products, including compliance with all laws, regulations and safety requirements or standards, regardless of any support or applications information provided by ON Semiconductor. "Typical" parameters which may be provided in ON Semiconductor data sheets and/or specifications can and do vary in different applications and actual performance may vary over time. All operating parameters, including "Typicals" must be validated for each customer application by customer's technical experts. ON Semiconductor does not convey any license under its patent rights nor the rights of others. ON Semiconductor products are not designed, intended, or authorized for use as a critical component in life support systems or any FDA Class 3 medical devices or medical devices with a same or similar classification in a foreign jurisdiction or any devices intended for implantation in the human body. Should Buyer purchase or use ON Semiconductor products for any such unintended or unauthorized application, Buyer shall indemnify and hold ON Semiconductor and its officers, employees, subsidiaries, affiliates, and distributors harmless against all claims, costs, damages, and expenses, and reasonable attorney fees arising out of, directly or indirectly, any claim of personal injury or death associated with such unintended or unauthorized use, even if such claim alleges that ON Semiconductor was negligent regarding the design or manufacture of the part. ON Semiconductor is an Equal Opportunity/Affirmative Action Employer. This literature is subject to all applicable copyright laws and is not for resale in any manner.



ON Semiconductor®

July 2017

# FAN53526 3.0 A, 2.4 MHz, Digitally Programmable TinyBuck® Regulator

## Features

- Fixed-Frequency Operation: 2.4 MHz
- Best-in-Class Load Transient
- Continuous Output Current Capability: 3.0 A
- 2.5 V to 5.5 V Input Voltage Range
- Digitally Programmable Output Voltage:
  - 0.600 V to 1.39375 V in 6.25 mV Steps
- Programmable Slew Rate for Voltage Transitions
- I<sup>2</sup>C-Compatible Interface Up to 3.4 Mbps
- PFM Mode for High Efficiency in Light-Load
- Quiescent Current in PFM Mode: 50  $\mu$ A (Typical)
- Input Under-Voltage Lockout (UVLO)
- Thermal Shutdown and Overload Protection
- 15-Bump Wafer-Level Chip Scale Package (WLCSP)

## Applications

- Application, Graphic, and DSP Processors
  - ARM™, Tegra™, OMAP™, NovaThor™, ARMADA™, Krait™, etc.
- Hard Disk Drives, LPDDR3, LPDDR4
- Tablets, Netbooks, Ultra-Mobile PCs
- Smart Phones
- Gaming Devices

All trademarks are the property of their respective owners.

## Description

The FAN53526 is a step-down switching voltage regulator that delivers a digitally programmable output from an input voltage supply of 2.5 V to 5.5 V. The output voltage is programmed through an I<sup>2</sup>C interface capable of operating up to 3.4 MHz.

Using a proprietary architecture with synchronous rectification, the FAN53526 is capable of delivering 3.0 A continuous at over 80% efficiency, maintaining that efficiency at load currents as low as 10 mA. The regulator operates at a nominal fixed frequency of 2.4 MHz, which reduces the value of the external components. Additional output capacitance can be added to improve regulation during load transients without affecting stability.

At moderate and light loads, Pulse Frequency Modulation (PFM) is used to operate in Power-Save Mode with a typical quiescent current of 50  $\mu$ A at room temperature. Even with such a low quiescent current, the part exhibits excellent transient response during large load swings. At higher loads, the system automatically switches to fixed-frequency control, operating at 2.4 MHz. In Shutdown Mode, the supply current drops below 1  $\mu$ A, reducing power consumption. PFM Mode can be disabled if fixed frequency is desired. The FAN53526 is available in a 15-bump, 1.310 mm x 2.015 mm, 0.4 mm ball pitch WLCSP.

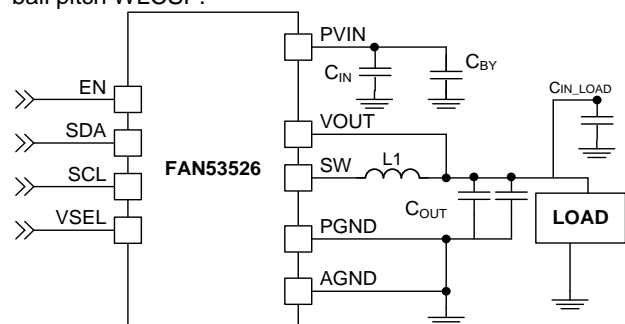

Figure 1. Typical Application

FAN53526 — 3.0 A, 2.4 MHz, Digitally Programmable TinyBuck® Regulator

## Ordering Information

Part Number	Power-Up Defaults		DVS Range / Step Size	Temperature Range	Package	Packing Method	Device Marking
	VSEL0	VSEL1					
FAN53526UC84X	1.125	1.125	0.600 V to 1.39375 V / 6.25 mV	-40 to 85°C	WLCSP	Tape & Reel	F7
FAN53526UC89X	1.15625	1.15625					CL
FAN53526UC100X	1.225	1.225					F9
FAN53526UC106X	1.2625	1.2625					C7
FAN53526UC128X	1.2	1.2					F3
FAN53526UC00X	0.60	0.60					GA

## Recommended External Components

**Table 1. Recommended External Components for 3.0 A Maximum Load Current**

Component	Description	Vendor	Parameter	Typ.	Unit
L1	330 nH, 2016 Case Size	See Table 2			
L1 Alternative <sup>(1)</sup>	470 nH 2016 Case Size				
C <sub>OUT1</sub> , C <sub>OUT2</sub>	47 µF, 6.3 V, X5R, 0603	GRM188R60J476ME15 (Murata)	C	47	µF
C <sub>OUT1</sub> , C <sub>OUT2</sub> Alternative <sup>(1)</sup>	22 µF, 10 V, X5R, 0603	CL10A226MP8NUNB (SAMSUNG)	C	22	
C <sub>IN</sub>	1 Piece; 4.7 µF, 10 V, X5R, 0603	C1608X5R1A475K (TDK)	C	4.7	
C <sub>BY</sub>	1 Piece; 100 nF, 6.3V, X5R, 0201	GRM033R60J104KE19D (Murata)	C	100	nF

**Note:**

- C<sub>OUT</sub> Alternative and L1 Alternative can be used if not following reference design. C<sub>BY</sub> is recommended to reduce any high frequency component on VIN bus. C<sub>BY</sub> is optional and used to filter any high frequency component on VIN bus.

**Table 2. Recommended Inductors**

Manufacturer	Part#	L (nH)	DCR (mΩ Typ.)	I <sub>SAT</sub> <sup>(2)</sup>	Component Dimensions		
					L	W	H
Toko	DFE201612E-R33N	330	15	7.0	2.0	1.6	1.2
Toko	DFE201612E-R47N	470	21	6.1	2.0	1.6	1.2
Cytek	PIFE20161B-R47MS-39	470	30	3.1	2.0	1.6	1.2
SEMCO	CIGT201610UMR47MNE	470	30	4.0	2.0	1.6	0.9
SEMCO	CIGT201210UMR47MNE	470	33	3.0	2.0	1.2	0.9

**Note:**

- I<sub>SAT</sub> where the dc current drops the inductance by 30%.

## Pin Configuration

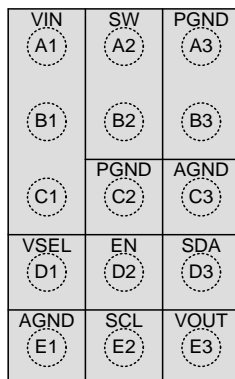

Figure 2. Top View

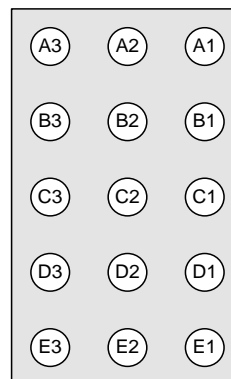

Figure 3. Bottom View

## Pin Definitions

Pin #	Name	Description
D1	VSEL	<b>Voltage Select.</b> When this pin is LOW, $V_{OUT}$ is set by the VSEL0 register. When this pin is HIGH, $V_{OUT}$ is set by the VSEL1 register. Polarity of pin in conjunction with the MODE bits in the Control register 02h, will select Forced PWM or Auto PFM/PWM mode of operation. VSEL0=Auto PFM, and VSEL1=FPWM. The VSEL pin has an internal pull-down resistor (250k $\Omega$ ), which is only activated with a logic low.
D2	EN	<b>Enable.</b> The device is in Shutdown Mode when this pin is LOW. Device keeps register content when EN pin is LOW. The EN Pin has an internal pull-down resistor (250k $\Omega$ ), which is only activated with a logic low.
E2	SCL	<b>I<sup>2</sup>C Serial Clock</b>
D3	SDA	<b>I<sup>2</sup>C Serial Data</b>
E3	VOUT	<b>VOUT.</b> Sense pin for $V_{OUT}$ . Connect to $C_{OUT}$ .
A3, B3, C2	PGND	<b>Power Ground.</b> The low-side MOSFET is referenced to this pin. $C_{IN}$ and $C_{OUT}$ should be returned with a minimal path to these pins.
C3, E1	AGND	<b>Analog Ground.</b> All signals are referenced to this pin. Avoid routing high dV/dt AC currents through this pin.
A1, B1, C1	VIN	<b>Power Input Voltage.</b> Connect to the input power source. Connect to $C_{IN}$ with minimal path.
A2, B2	SW	<b>Switching Node.</b> Connect to the inductor.

## Absolute Maximum Ratings

Stresses exceeding the absolute maximum ratings may damage the device. The device may not function or be operable above the recommended operating conditions and stressing the parts to these levels is not recommended. In addition, extended exposure to stresses above the recommended operating conditions may affect device reliability. The absolute maximum ratings are stress ratings only.

Symbol	Parameter	Min.	Max.	Unit	
V <sub>IN</sub>	Voltage on SW, VIN Pins	IC Not Switching	-0.3	7.0	V
		IC Switching	-0.3	6.5	
	Voltage on EN Pin	-0.3	V <sub>IN</sub> <sup>(3)</sup>		
	Voltage on All Other Pins	IC Not Switching	-0.3	V <sub>IN</sub> <sup>(3)</sup>	
V <sub>OUT</sub>	Voltage on VOUT Pin	-0.3	6.5	V	
V <sub>INOV_SLEW</sub>	Maximum Slew Rate of V <sub>IN</sub> > 6.5 V, PWM Switching		100	V/ms	
ESD	Human Body Model, ANSI/ESDA/JEDEC JS-001-2012	2000		V	
	Charged Device Model per JESD22-C101	1000			
T <sub>J</sub>	Junction Temperature	-40	+150	°C	
T <sub>STG</sub>	Storage Temperature	-65	+150	°C	
T <sub>L</sub>	Lead Soldering Temperature, 10 Seconds		+260	°C	

### Note:

3. Lesser of 7 V or V<sub>IN</sub>+0.3 V.

## Recommended Operating Conditions

The Recommended Operating Conditions table defines the conditions for actual device operation. Recommended operating conditions are specified to ensure optimal performance to the datasheet specifications. On Semiconductor does not recommend exceeding them or designing to Absolute Maximum Ratings.

Symbol	Parameter	Min.	Typ.	Max.	Unit
V <sub>IN</sub>	Supply Voltage Range	2.5		5.5	V
I <sub>OUT</sub>	Output Current	0		3.0	A
T <sub>A</sub>	Operating Ambient Temperature	-40		+85	°C
T <sub>J</sub>	Operating Junction Temperature	-40		+125	°C

## Thermal Properties

Symbol	Parameter	Min.	Typ.	Max.	Unit
θ <sub>JA</sub>	Junction-to-Ambient Thermal Resistance <sup>(4)</sup>		42		°C/W

### Note:

4. Junction-to-ambient thermal resistance is a function of application and board layout. This data is simulated with four-layer 2s2p boards with vias in accordance to JESD51- JEDEC standard. Special attention must be paid not to exceed the junction temperature.

## Electrical Characteristics

Minimum and maximum values are at  $V_{IN}=3.6\text{ V}$ ,  $T_A=-40^\circ\text{C}$  to  $+85^\circ\text{C}$ , unless otherwise noted. Typical values are at  $T_A=25^\circ\text{C}$ ,  $V_{IN}=3.6\text{ V}$ , and  $EN=HIGH$ .  $V_{OUT} = 1.15625\text{ V}$ .

Symbol	Parameter	Condition	Min.	Typ.	Max.	Unit
<b>Power Supplies</b>						
$I_Q$	Quiescent Current	$I_{LOAD}=0$		50		$\mu\text{A}$
		$I_{LOAD}=0$ , MODE Bit=1 (Forced PWM)		15		$\text{mA}$
$I_{SD}$	H/W Shutdown Supply Current	$EN=GND$		0.1	3.0	$\mu\text{A}$
	S/W Shutdown Supply Current	$EN=V_{IN}$ , BUCK_ENx=0, $2.5\text{ V} \leq V_{IN} \leq 5.5\text{ V}$		2	12	$\mu\text{A}$
$V_{UVLO}$	Under-Voltage Lockout Threshold	$V_{IN}$ Rising		2.32	2.45	V
$V_{UVHYST}$	Under-Voltage Lockout Hysteresis			350		mV
<b>EN, VSEL, SDA, SCL</b>						
$V_{IH}$	HIGH-Level Input Voltage	$2.5\text{ V} \leq V_{IN} \leq 5.5\text{ V}$	1.1			V
$V_{IL}$	LOW-Level Input Voltage	$2.5\text{ V} \leq V_{IN} \leq 5.5\text{ V}$			0.4	V
$I_{IN}$	Input Bias Current	Input Tied to GND or $V_{IN}$		0.01	1.00	$\mu\text{A}$
<b><math>V_{OUT}</math> Regulation</b>						
$V_{REG}$	$V_{OUT}$ DC Accuracy	$2.5\text{ V} \leq V_{IN} \leq 5.5\text{ V}$ , $V_{OUT}$ from Minimum to Maximum, $I_{OUT(DC)}=0$ to 3.0 A, Auto PFM/PWM	-2.5		2.5	%
		$2.5\text{ V} \leq V_{IN} \leq 5.5\text{ V}$ , $V_{OUT}$ from Minimum to Maximum, $I_{OUT(DC)}=0$ to 3.0 A, Forced PWM	-1.5		1.5	
		$V_{IN}=3.8\text{ V}$ , $V_{OUT}=0.6\text{ V}$ , $I_{OUT(DC)}=500\text{ mA}$ , Auto PFM/PWM	-2.3		-0.5	mV
		-14		-3		
$\frac{\Delta V_{OUT}}{\Delta I_{LOAD}}$	Load Regulation	$I_{OUT(DC)}=1$ to 3 A		-0.01		%/A
$\frac{\Delta V_{OUT}}{\Delta V_{IN}}$	Line Regulation	$2.5\text{ V} \leq V_{IN} \leq 5.5\text{ V}$ , $I_{OUT(DC)}=1.5\text{ A}$		0.01		%/V
$V_{TRSP}$	Transient Response	$I_{LOAD}$ Step 0.01 A $\leftrightarrow$ 1.5 A, $t_r=t_f=200\text{ ns}$ , $V_{OUT}=1.15625\text{ V}$		$\pm 50$		mV
		$I_{LOAD}$ Step 0 A $\leftrightarrow$ 500 mA, $t_r=t_f=100\text{ ns}$ , $V_{IN}=3.8\text{ V}$ , $V_{OUT}=0.6\text{ V}$		$\pm 16$		
<b>Power Switch / Protection</b>						
$I_{LIMPK}$	P-MOS Peak Current Limit		4.00	4.75	5.50	A
$T_{LIMIT}$	Thermal Shutdown			150		$^\circ\text{C}$
$T_{HYST}$	Thermal Shutdown Hysteresis			17		$^\circ\text{C}$
$V_{SDWN}$	Input OVP Shutdown	Rising Threshold		6.15		V
		Falling Threshold	5.50	5.73		
<b>Frequency Control</b>						
$f_{SW}$	Oscillator Frequency		2.05	2.40	2.75	MHz
<b>DAC</b>						
	Resolution			7		Bits
	Differential Nonlinearity <sup>(5)</sup>				0.5	LSB
<b>Soft-Start</b>						
$t_{SS}$	Regulator Enable to Regulated $V_{OUT}$	$R_{LOAD} > 5\ \Omega$ , $V_{OUT}=1.15625\text{ V}$ , From EN Rising Edge to 95% $V_{OUT}$		150		$\mu\text{s}$

5. Monotonicity assured by design.

## I<sup>2</sup>C Timing Specifications

Guaranteed by design.

Symbol	Parameter	Condition	Min.	Typ.	Max.	Unit
f <sub>SCL</sub>	SCL Clock Frequency	Standard Mode			100	kHz
		Fast Mode			400	
		Fast Mode Plus			1000	
		High-Speed Mode, C <sub>B</sub> ≤ 100 pF			3400	
		High-Speed Mode, C <sub>B</sub> ≤ 400 pF			1700	
t <sub>BUF</sub>	Bus-Free Time between STOP and START Conditions	Standard Mode		4.7		μs
		Fast Mode		1.3		
		Fast Mode Plus		0.5		
t <sub>HD,STA</sub>	START or REPEATED START Hold Time	Standard Mode		4		μs
		Fast Mode		600		ns
		Fast Mode Plus		260		
		High-Speed Mode		160		
t <sub>LOW</sub>	SCL LOW Period	Standard Mode		4.7		μs
		Fast Mode		1.3		
		Fast Mode Plus		0.5		
		High-Speed Mode, C <sub>B</sub> ≤ 100 pF		160		ns
		High-Speed Mode, C <sub>B</sub> ≤ 400 pF		320		
t <sub>HIGH</sub>	SCL HIGH Period	Standard Mode		4		μs
		Fast Mode		600		
		Fast Mode Plus		260		ns
		High-Speed Mode, C <sub>B</sub> ≤ 100 pF		60		
		High-Speed Mode, C <sub>B</sub> ≤ 400 pF		120		
t <sub>SU,STA</sub>	REPEATED START Setup Time	Standard Mode		4.7		μs
		Fast Mode		600		ns
		Fast Mode Plus		260		
		High-Speed Mode		160		
t <sub>SU,DAT</sub>	Data Setup Time	Standard Mode		250		ns
		Fast Mode		100		
		Fast Mode Plus		50		
		High-Speed Mode		10		
t <sub>HD,DAT</sub>	Data Hold Time	Standard Mode	0		3.45	μs
		Fast Mode	0		900	ns
		Fast Mode Plus	0		450	
		High-Speed Mode, C <sub>B</sub> ≤ 100 pF	0		70	
		High-Speed Mode, C <sub>B</sub> ≤ 400 pF	0		150	
t <sub>RCL</sub>	SCL Rise Time	Standard Mode	20+0.1C <sub>B</sub>		1000	ns
		Fast Mode	20+0.1C <sub>B</sub>		300	
		Fast Mode Plus	20+0.1C <sub>B</sub>		120	
		High-Speed Mode, C <sub>B</sub> ≤ 100 pF		10	80	
		High-Speed Mode, C <sub>B</sub> ≤ 400 pF		20	160	

Continued on the following page...

**I<sup>2</sup>C Timing Specifications** (Continued)

Guaranteed by design.

Symbol	Parameter	Condition	Min.	Typ.	Max.	Unit
t <sub>FCL</sub>	SCL Fall Time	Standard Mode	20+0.1C <sub>B</sub>		300	ns
		Fast Mode	20+0.1C <sub>B</sub>		300	
		Fast Mode Plus	20+0.1C <sub>B</sub>		120	
		High-Speed Mode, C <sub>B</sub> ≤ 100 pF		10	40	
		High-Speed Mode, C <sub>B</sub> ≤ 400 pF		20	80	
t <sub>RCL1</sub>	Rise Time of SCL After a REPEATED START Condition and After ACK Bit	High-Speed Mode, C <sub>B</sub> ≤ 100 pF		10	80	ns
		High-Speed Mode, C <sub>B</sub> ≤ 400 pF		20	160	
t <sub>RDA</sub>	SDA Rise Time	Standard Mode	20+0.1C <sub>B</sub>		1000	ns
		Fast Mode	20+0.1C <sub>B</sub>		300	
		Fast Mode Plus	20+0.1C <sub>B</sub>		120	
		High-Speed Mode, C <sub>B</sub> ≤ 100 pF		10	80	
		High-Speed Mode, C <sub>B</sub> ≤ 400 pF		20	160	
t <sub>FDA</sub>	SDA Fall Time	Standard Mode	20+0.1C <sub>B</sub>		300	ns
		Fast Mode	20+0.1C <sub>B</sub>		300	
		Fast Mode Plus	20+0.1C <sub>B</sub>		120	
		High-Speed Mode, C <sub>B</sub> ≤ 100 pF		10	80	
		High-Speed Mode, C <sub>B</sub> ≤ 400 pF		20	160	
t <sub>SU;STO</sub>	Stop Condition Setup Time	Standard Mode		4		μs
		Fast Mode		600		ns
		Fast Mode Plus		120		
		High-Speed Mode		160		
C <sub>B</sub>	Capacitive Load for SDA and SCL				400	pF



## Timing Diagrams

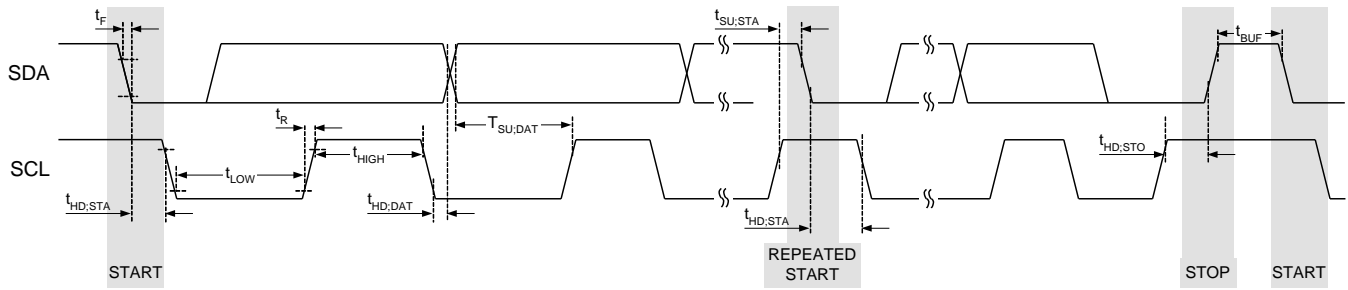
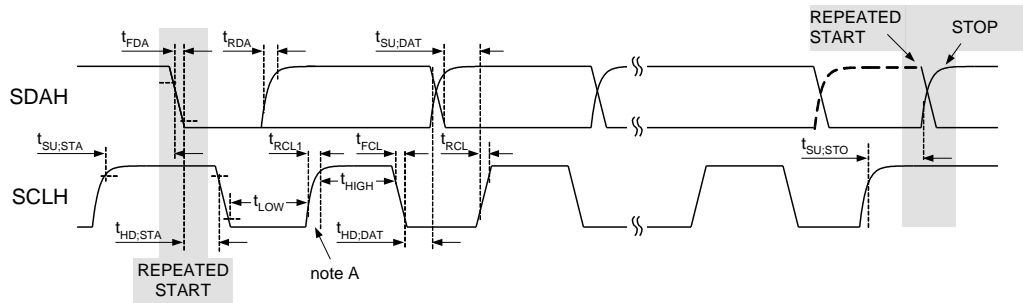



Figure 4. I<sup>2</sup>C Interface Timing for Fast Plus, Fast, and Slow Modes



-  = MCS Current Source Pull-up
-  = R<sub>p</sub> Resistor Pull-up

Note A: First rising edge of SCLH after Repeated Start and after each ACK bit.

Figure 5. I<sup>2</sup>C Interface Timing for High-Speed Mode

## Typical Characteristics

Unless otherwise specified, Auto PFM/PWM Mode,  $V_{IN} = 3.6\text{ V}$ ,  $V_{OUT} = 1.15625\text{ V}$ ,  $V_{SEL} = EN = V_{IN}$ ,  $T_A = 25^\circ\text{C}$ ; circuit and components according to Figure 1 and Table 1. Efficiency test conditions;  $I_{LOAD}$ : 1 mA to 3 A,  $L = 330\text{ nH}$ , DFE201612E-R33N (Toko).  $C_{IN} = 4.7\text{ }\mu\text{F}$ , 0603, C1608X5R1A475K (TDK),  $C_{OUT} \times 2 = 2 \times 2X47\text{ }\mu\text{F}$ , 0603, GRM188R60J476ME (Murata).

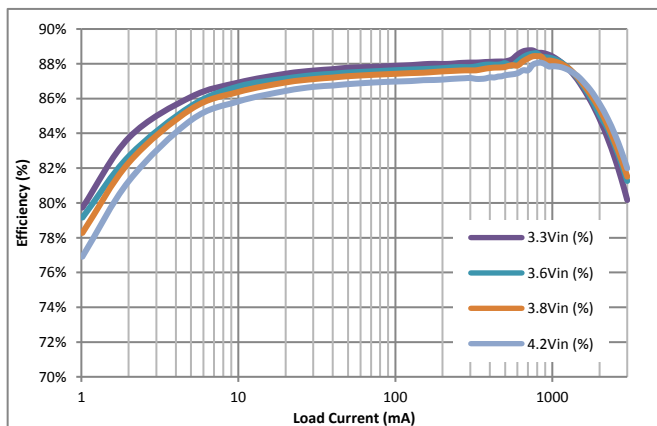

**Figure 6. Efficiency vs. Load Current and Input Voltage,  $V_{OUT}=1.15625\text{ V}$**

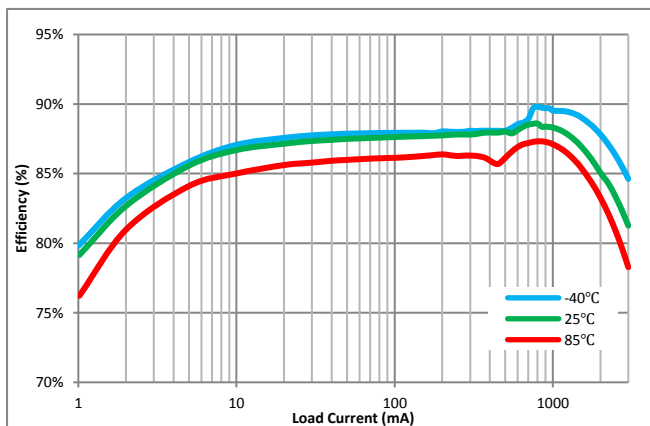

**Figure 7. Efficiency vs. Load Current and Temperature,  $V_{IN}=3.6\text{ V}$ ,  $V_{OUT}=1.15625\text{ V}$**

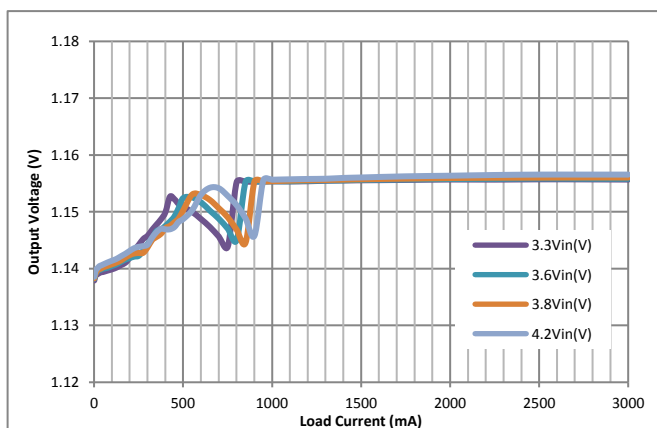

**Figure 8. Output Regulation vs. Load Current and Input Voltage,  $V_{OUT}=1.15625\text{ V}$**

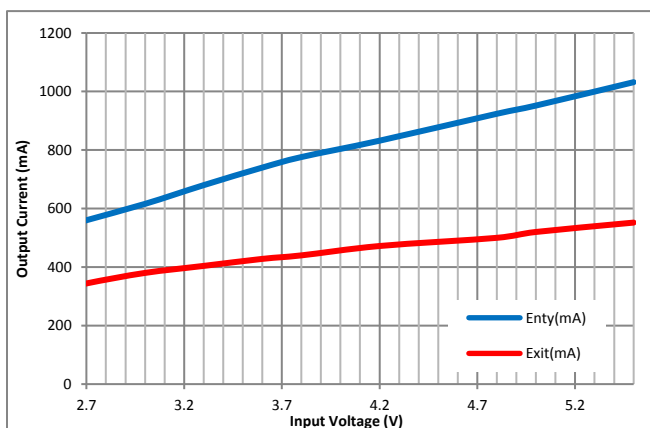

**Figure 9. PWM Entry / Exit Level vs. Input Voltage,  $V_{OUT}=1.15625\text{ V}$**

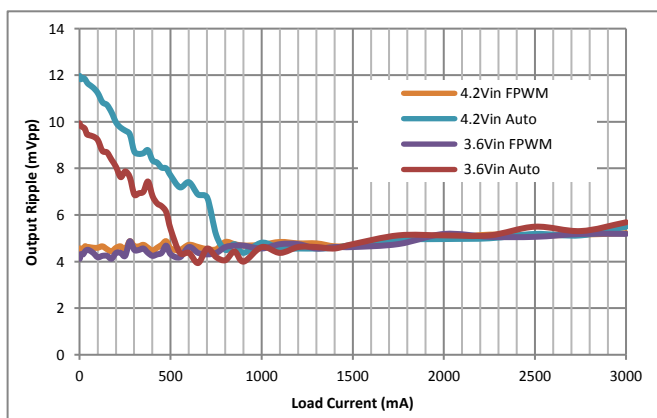

**Figure 10. Output Ripple vs. Load Current,  $V_{IN}=4.2\text{ V}$  and  $3.6\text{ V}$ ,  $V_{OUT}=1.15625\text{ V}$ , Auto and Forced PWM**

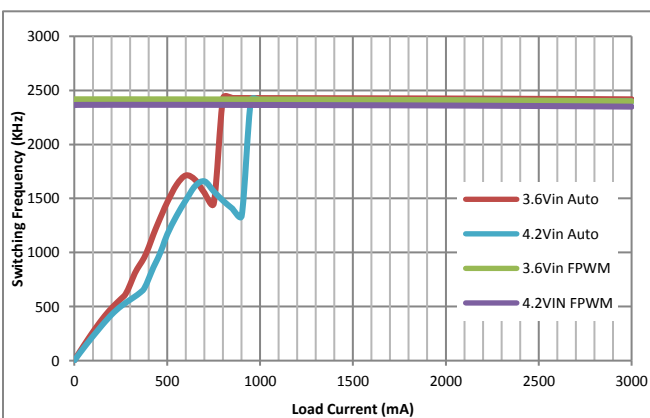

**Figure 11. Frequency vs. Load Current,  $V_{IN}=4.2\text{ V}$  and  $3.6\text{ V}$ ,  $V_{OUT}=1.15625\text{ V}$ , Auto PWM**

## Typical Characteristics

Unless otherwise specified, Auto PFM/PWM Mode,  $V_{IN} = 3.6\text{ V}$ ,  $V_{OUT} = 1.15625\text{ V}$ ,  $V_{SEL} = EN = V_{IN}$ ,  $T_A = 25^\circ\text{C}$ ; circuit and components according to Figure 1 and Table 1. Efficiency test conditions;  $I_{LOAD}$ : 1 mA to 3 A,  $L = 330\text{ nH}$ , DFE201612E-R33N (Toko).  $C_{IN} = 4.7\text{ }\mu\text{F}$ , 0603, C1608X5R1A475K (TDK),  $C_{OUT} \times 2 = 2 \times 2X47\text{ }\mu\text{F}$ , 0603, GRM188R60J476ME (Murata).

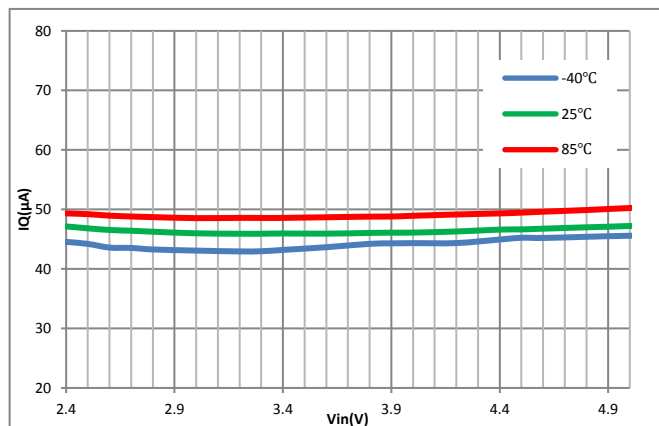

Figure 12. Quiescent Current vs. Input Voltage and Temperature, Auto Mode,  $V_{OUT}=1.15625\text{ V}$

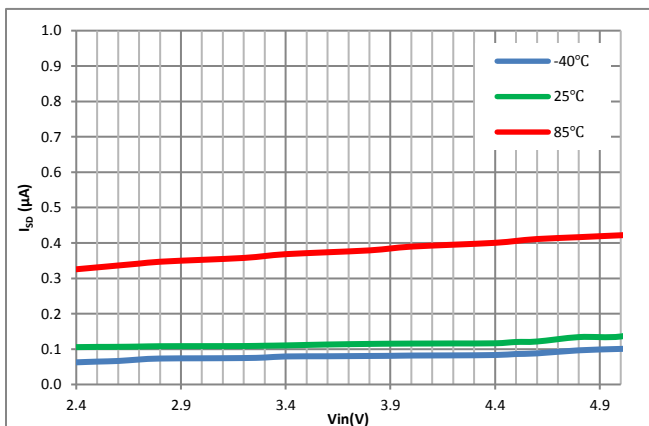

Figure 13. Shutdown Current vs. Input Voltage and Temperature

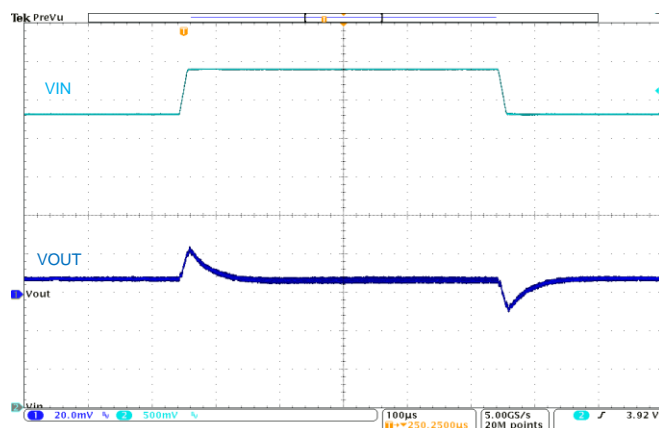

Figure 14. Line Transient, 3.6-4.2  $V_{IN}$ , 1.15625  $V_{OUT}$ , 10  $\mu\text{s}$  Edge at 1 A Load

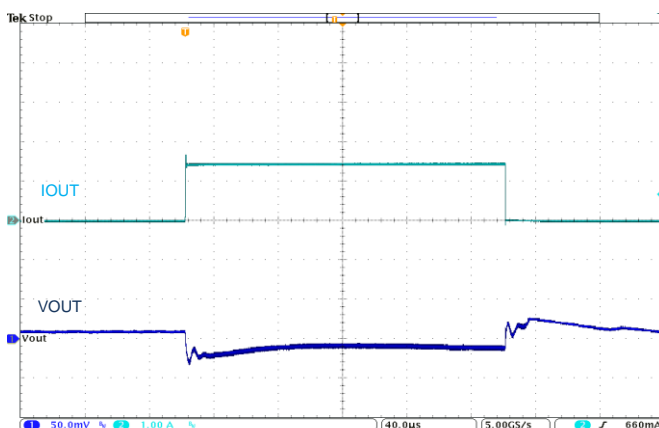

Figure 15. Load Transient, 3.6  $V_{IN}$ , 1.15625  $V_{OUT}$ , 0.01-1.5 A, 120 ns Edge

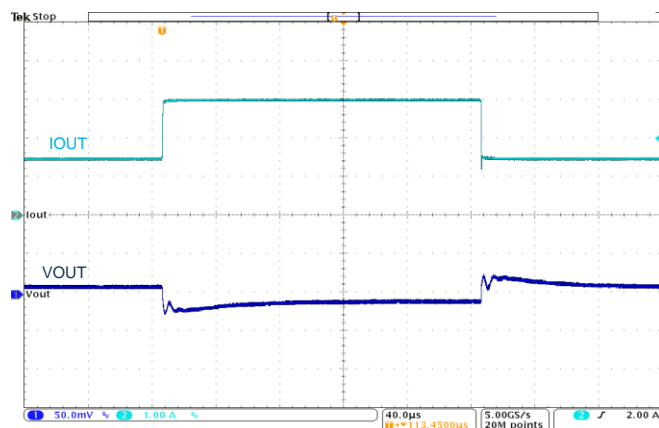

Figure 16. Load Transient, 3.6  $V_{IN}$ , 1.15625  $V_{OUT}$ , 1.5-3 A, 120 ns Edge

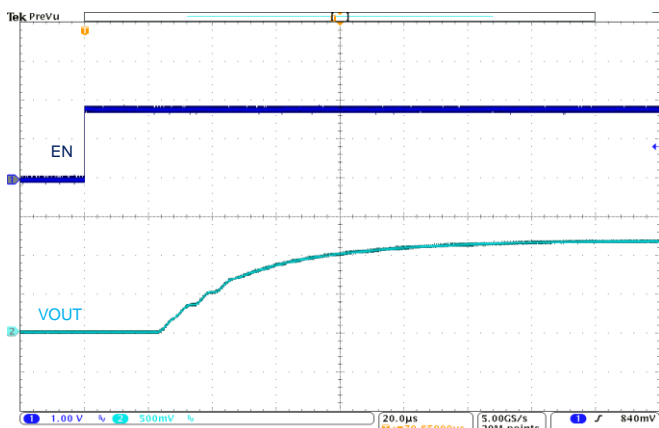
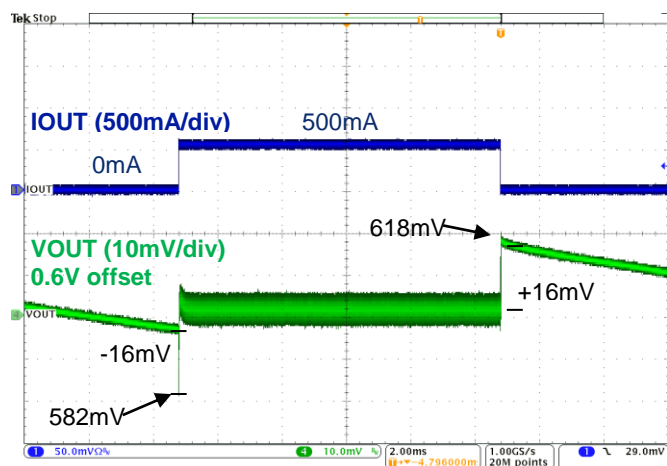

Figure 17. Startup, 5  $\Omega$  Load,  $V_{OUT}=1.15625\text{ V}$ ,  $V_{IN}=3.6\text{ V}$

## Typical Characteristics

Unless otherwise specified, Auto PFM/PWM Mode,  $V_{IN} = 3.6\text{ V}$ ,  $V_{OUT} = 1.15625\text{ V}$ ,  $V_{SEL} = EN = V_{IN}$ ,  $T_A = 25^\circ\text{C}$ ; circuit and components according to Figure 1 and Table 1. Efficiency test conditions;  $I_{LOAD}$ : 1 mA to 3 A,  $L = 330\text{ nH}$ , DFE201612E-R33N (Toko).  $C_{IN} = 4.7\text{ }\mu\text{F}$ , 0603, C1608X5R1A475K (TDK),  $C_{OUT} \times 2 = 2 \times 2X47\text{ }\mu\text{F}$ , 0603, GRM188R60J476ME (Murata).



**Figure 18. Load Transient, 3.8  $V_{IN}$ , 0.6  $V_{OUT}$ , 0-500 mA, 100 ns Edge, 47  $\mu\text{F}$   $C_{OUT}$**

## Operation Description

The FAN53526 is a step-down switching voltage regulator that delivers a programmable output voltage from an input voltage supply of 2.5 V to 5.5 V. Using a proprietary architecture with synchronous rectification, the FAN53526 is capable of delivering 3.0 A at over 80% efficiency. The regulator operates at a nominal frequency of 2.4 MHz at full load, which reduces the value of the external components to 330 nH or 470 nH for the output inductor and 44  $\mu$ F for the output capacitor. High efficiency is maintained at light load with single-pulse PFM.

An I<sup>2</sup>C-compatible interface allows transfers up to 3.4 Mbps. This communication interface can be used to:

- Dynamically re-program the output voltage in 6.25 mV increments;
- Reprogram the mode to enable or disable PFM;
- Control voltage transition slew rate; or
- Enable / disable the regulator.

## Control Scheme

The FAN53526 uses a proprietary non-linear, fixed-frequency PWM modulator to deliver a fast load transient response, while maintaining a constant switching frequency over a wide range of operating conditions. The regulator performance is independent of the output capacitor ESR, allowing for the use of ceramic output capacitors. Although this type of operation normally results in a switching frequency that varies with input voltage and load current, an internal frequency loop holds the switching frequency constant over a large range of input voltages and load currents.

For very light loads, the FAN53526 operates in Discontinuous Current Mode (DCM) single-pulse PFM, which produces low output ripple compared with other PFM architectures. Transition between PWM and PFM is relatively seamless, providing a smooth transition between DCM and CCM Modes.

PFM can be disabled by programming the MODE bits in the CONTROL register in combination with the state of the VSEL pin. See table in the Control Register, 02h.

## Enable and Soft-Start

When the EN pin is LOW; the IC is shut down, all internal circuits are off, and the part draws very little current. In this state, I<sup>2</sup>C can be written to or read from as long as input voltage is above the UVLO. The registers keep the content when the EN pin is LOW. The registers are reset to default values during a Power On Reset (POR). When the OUTPUT\_DISCHARGE bit in the Control register is enabled (logic HIGH) and the EN pin is LOW or the BUCK\_ENx bit is LOW, an 11  $\Omega$  load is connected from VOUT to GND to discharge the output capacitors.

Raising EN while the BUCK\_ENx bit is HIGH activates the part and begins the soft-start cycle. During soft-start, the modulator's internal reference is ramped slowly to minimize surge currents on the input and prevent overshoot of the output voltage. Synchronous rectification is inhibited, allowing the IC to start into a pre-charged capacitive load.

If large values of output capacitance are used, the regulator may fail to start. The maximum C<sub>OUT</sub> capacitance for starting with a heavy constant-current load is approximately:

$$C_{OUTMAX} \approx (I_{LIMPK} - I_{LOAD}) \cdot \frac{320\mu}{V_{OUT}} \quad (1)$$

where C<sub>OUTMAX</sub> is expressed in  $\mu$ F and I<sub>LOAD</sub> is the load current during soft-start, expressed in A.

If the regulator is at its current limit for 16 consecutive current limit cycles, the regulator shuts down and enters tri-state before reattempting soft-start 1700  $\mu$ s later. This limits the duty cycle of full output current during soft-start to prevent excessive heating.

The IC allows for software enable of the regulator, when EN is HIGH, through the BUCK\_EN bits. BUCK\_EN0 and BUCK\_EN1 are both initialized HIGH. These options start after a POR, regardless of the state of the VSEL pin.

**Table 3. Hardware and Software Enable**

Pins		BITS			
EN	VSEL	BUCK_EN0	BUCK_EN1	Output	Mode
0	X	X	X	OFF	Shutdown
1	0	0	X	OFF	Shutdown
1	0	1	X	ON	Auto
1	1	X	0	OFF	Shutdown
1	1	X	1	ON	FPWM

## VSEL Pin and I<sup>2</sup>C Programming Output Voltage

The output voltage is set by the NSELx control bits in VSEL0 and VSEL1 registers. The output is given as:

$$V_{OUT} = 0.600V + NSELx \cdot 6.25mV \quad (2)$$

For example, if NSEL = 1010000 (80 decimal), then V<sub>OUT</sub> = 0.600 + 0.5 = 1.100 V.

Output voltage can also be controlled by toggling the VSEL pin LOW or HIGH. VSEL LOW corresponds to VSEL0 and VSEL HIGH corresponds to VSEL1. Upon POR, VSEL0 and VSEL1 are reset to their default voltages, as shown in Table 7

## Transition Slew Rate Limiting

When transitioning from a low to high voltage, the IC can be programmed for one of eight possible slew rates using the SLEW bits in the Control register, as shown in Table 4.

**Table 4. Transition Slew Rate**

Decimal	Bin	Slew Rate	
0	000	64.00	mV/μs
1	001	32.00	mV/μs
2	010	16.00	mV/μs
3	011	8.00	mV/μs
4	100	4.00	mV/μs
5	101	2.00	mV/μs
6	110	1.00	mV/μs
7	111	0.50	mV/μs

Transitions from high to low voltage rely on the output load to discharge  $V_{OUT}$  to the new set point. Once the high-to-low transition begins, the IC stops switching until  $V_{OUT}$  has reached the new set point.

## Under-Voltage Lockout (UVLO)

When EN is HIGH, the under-voltage lockout keeps the part from operating until the input supply voltage rises HIGH enough to properly operate. This ensures proper operation of the regulator during startup or shutdown.

## Input Over-Voltage Protection (OVP)

When  $V_{IN}$  exceeds  $V_{SDWN}$  (~ 6.2 V), the IC stops switching to protect the circuitry from internal spikes above 6.5 V. An internal filter prevents the circuit from shutting down due to noise spikes.

## Current Limiting

A heavy load or short circuit on the output causes the current in the inductor to increase until a maximum current threshold is reached in the high-side switch. Upon reaching this point, the high-side switch turns off, preventing high currents from causing damage. 16 consecutive current limit cycles in current limit, cause the regulator to shut down and stay off for about 1700 μs before attempting a restart.

## Thermal Shutdown

When the die temperature increases, due to a high load condition and/or high ambient temperature, the output switching is disabled until the die temperature falls sufficiently. The junction temperature at which the thermal shutdown activates is nominally 150°C with a 17°C hysteresis.

## Monitor Register (Reg05)

The Monitor register indicates of the regulation state of the IC. If the IC is enabled and is regulating, its value is (1000 0001).

## I<sup>2</sup>C Interface

The serial interface is compatible with Standard, Fast, Fast Plus, and HS Mode I<sup>2</sup>C Bus® specifications. The SCL line is an input and its SDA line is a bi-directional open-drain output; it can only pull down the bus when active. The SDA line only

pulls LOW during data reads and when signaling ACK. All data is shifted in MSB (bit 7) first.

## I<sup>2</sup>C Slave Address

In hex notation, the slave address assumes a 0 LS Bit. The hex slave address is C0.

**Table 5. I<sup>2</sup>C Slave Address**

Hex	Bits							
	7	6	5	4	3	2	1	0
C0	1	1	0	0	0	0	0	R/W

Other slave addresses can be assigned. Contact an On Semiconductor representative.

## Bus Timing

As shown in Figure 19 data is normally transferred when SCL is LOW. Data is clocked in on the rising edge of SCL. Typically, data transitions shortly at or after the falling edge of SCL to allow sufficient time for the data to set up before the next SCL rising edge.

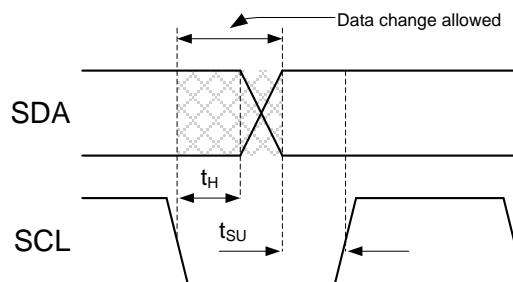

**Figure 19. Data Transfer Timing**

Each bus transaction begins and ends with SDA and SCL HIGH. A transaction begins with a START condition, which is defined as SDA transitioning from 1 to 0 with SCL HIGH, as shown in Figure 20.

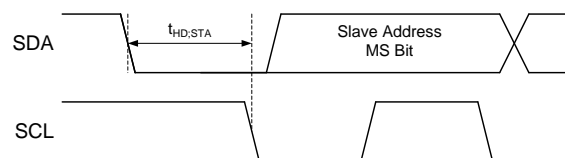

**Figure 20. START Bit**

A transaction ends with a STOP condition, defined as SDA transitioning from 0 to 1 with SCL high, as shown in Figure 21.

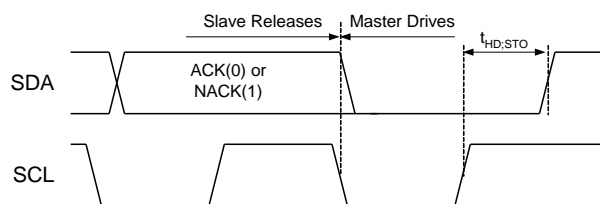

**Figure 21. STOP Bit**

During a read from the FAN53526, the master issues a REPEATED START after sending the register address and before resending the slave address. The REPEATED START is a 1 to 0 transition on SDA while SCL is HIGH, as shown in Figure 22.

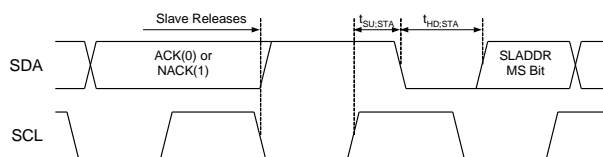

**Figure 22. REPEATED START Timing**

### High-Speed (HS) Mode

The protocols for High-Speed (HS), Low-Speed (LS), and Fast-Speed (FS) Modes are identical; except the bus speed for HS Mode is 3.4 MHz. HS Mode is entered when the bus master sends the HS master code 00001XXX after a START condition (Figure 20). The master code is sent in Fast or Fast-Plus Mode (less than 1 MHz clock); slaves do not ACK this transmission.

The master generates a REPEATED START condition (Figure 22) that causes all slaves on the bus to switch to HS Mode. The master then sends I<sup>2</sup>C packets, as described above, using the HS Mode clock rate and timing.

The bus remains in HS Mode until a STOP bit (Figure 21) is sent by the master. While in HS Mode, packets are separated by REPEATED START conditions (Figure 22).

### Read and Write Transactions

The following figures outline the sequences for data read and write. Bus control is signified by the shading of the packet, defined as Master Drives Bus and Slave Drives Bus. All addresses and data are MSB first.

**Table 6. I<sup>2</sup>C Bit Definitions for Figure 23 and Figure 24**

Symbol	Definition
S	START, <i>see Figure 20</i>
P	STOP, <i>see Figure 21</i>
R	REPEATED START, <i>see Figure 22</i>
A	ACK. The slave drives SDA to 0 to acknowledge the preceding packet.
$\bar{A}$	NACK. The slave sends a 1 to NACK the preceding packet.



**Figure 23. Write Transaction**



**Figure 24. Write Transaction Followed by a Read Transaction**

## Register Description

Table 7. Register Map

Hex Address	Name	Function	Binary	Hex
00	VSEL0	Controls V <sub>OUT</sub> settings when VSEL pin = LOW	1XXXXXXX	XX
01	VSEL1	Controls V <sub>OUT</sub> settings when VSEL pin = HIGH	1XXXXXXX	XX
02	CONTROL	Determines whether V <sub>OUT</sub> output discharge is enabled and also the slew rate of positive transitions	1000010	82
03	ID1	Read-only register identifies vendor and chip type	10000001	81
04	ID2	Read-only register identifies die revision	00001000	08
05	MONITOR	Indicates device status	00000000	00

### Bit Definitions

The following table defines the operation of each register bit. Bold indicates power-on default values.

Bit	Name	Type	Value	Description		
<b>VSEL0</b> <span style="float: right;"><b>Register Address: 00</b></span>						
7	BUCK_EN0	R/W	<b>1</b>	Software buck enable. When EN pin is LOW, the regulator is off. When EN pin is HIGH, BUCK_EN bit takes precedent.		
6:0	NSEL0	R/W	<b>XXX XXXX</b>	Sets V <sub>OUT</sub> value from 0.600 to 1.39375 V (see Eq. (2)).		
<b>VSEL1</b> <span style="float: right;"><b>Register Address: 01</b></span>						
7	BUCK_EN1	R/W	<b>1</b>	Software buck enable. When EN pin is LOW, the regulator is off. When EN pin is HIGH, BUCK_EN bit takes precedent.		
6:0	NSEL1	R/W	<b>XXX XXXX</b>	Sets V <sub>OUT</sub> value from 0.600 to 1.39375 V (see Eq. (2)).		
<b>CONTROL</b> <span style="float: right;"><b>Register Address: 02</b></span>						
7	OUTPUT_DISCHARGE	R/W	0	When the regulator is disabled, V <sub>OUT</sub> is not discharged.		
			<b>1</b>	When the regulator is disabled, V <sub>OUT</sub> discharges through an internal pull-down.		
6:4	SLEW	R/W	<b>000</b> –111	Sets the slew rate for positive voltage transitions (see Table 4).		
3	Reserved		<b>0</b>	Always reads back 0.		
2	RESET	R/W	<b>0</b>	Setting to 1 resets all registers to default values. Always reads back 0.		
1:0	MODE	R/W	<b>10</b>	In combination with the VSEL pin, these two bits set the operation of the buck to be either in Auto-PFM/PWM Mode during light load or Forced PWM mode. See table below. Mode of Operation		
				<b>VSEL Pin</b>	<b>Binary</b>	<b>Operation</b>
				Low	X0	Auto PFM/PWM
				Low	X1	Forced PWM
				High	0X	Auto PFM/PWM
High	1X	Forced PWM				
<b>ID1</b> <span style="float: right;"><b>Register Address: 03</b></span>						
7:5	VENDOR	R	<b>100</b>	Signifies On Semiconductor as the IC vendor.		
4	Reserved	R	<b>0</b>	Always reads back 0.		
3:0	DIE_ID	R	<b>0001</b>	DIE ID - FAN53525/6.		
<b>ID2</b> <span style="float: right;"><b>Register Address: 04</b></span>						
7:4	Reserved	R	<b>0000</b>	Always reads back 0000.		
3:0	DIE_REV	R	<b>1000</b>	FAN53526 Die Revision		



**Bit Definitions** (Continued)

The following table defines the operation of each register bit. Bold indicates power-on default values.

Bit	Name	Type	Value	Description
<b>MONITOR</b>				<b>Register Address: 05</b>
7	PGOOD	R	<b>0</b>	1: Buck is enabled and soft-start is completed.
6	UVLO	R	<b>0</b>	1: Signifies the VIN is less than the UVLO threshold.
5	OVP	R	<b>0</b>	1: Signifies the VIN is greater than the OVP threshold.
4	POS	R	<b>0</b>	1: Signifies a positive voltage transition is in progress and the output voltage has not yet reached its new setpoint. This bit is also set during IC soft-start.
3	NEG	R	<b>0</b>	1: Signifies a negative voltage transition is in progress and the output voltage has not yet reached its new setpoint.
2	RESET_STAT	R	<b>0</b>	1: Indicates that a register reset was performed. This bit is cleared after register 5 is read.
1	OT	R	<b>0</b>	1: Signifies the thermal shutdown is active.
0	BUCK_STATUS	R	<b>0</b>	1: Buck enabled; 0: buck disabled.

## Application Information

### Selecting the Inductor

The output inductor must meet both the required inductance and the energy-handling capability of the application. The inductor value affects the average current limit, the output voltage ripple, and the efficiency.

The ripple current ( $\Delta I$ ) of the regulator is:

$$\Delta I \approx \frac{V_{OUT}}{V_{IN}} \cdot \left( \frac{V_{IN} - V_{OUT}}{L \cdot f_{SW}} \right) \quad (3)$$

The maximum average load current,  $I_{MAX(Load)}$ , is related to the peak current limit,  $I_{LIM(PK)}$ , by the ripple current such that:

$$I_{MAX(Load)} = I_{LIM(PK)} - \frac{\Delta I}{2} \quad (4)$$

The FAN53526 is optimized for operation with  $L=330$  nH, but is stable with inductances up to  $1.0$   $\mu$ H (nominal). The inductor should be rated to maintain at least 80% of its value at  $I_{LIM(PK)}$ . Failure to do so decreases the amount of DC current the IC can deliver.

Efficiency is affected by the inductor DCR and inductance value. Decreasing the inductor value for a given physical size typically decreases the DCR; but since  $\Delta I$  increases, the RMS current increases, as do core and skin-effect losses:

$$I_{RMS} = \sqrt{I_{OUT(DC)}^2 + \frac{\Delta I^2}{12}} \quad (5)$$

The increased RMS current produces higher losses through the  $R_{DS(ON)}$  of the IC MOSFETs and the inductor ESR.

Increasing the inductor value produces lower RMS currents, but degrades transient response. For a given physical inductor size, increased inductance usually results in an inductor with lower saturation current.

**Table 8. Effects of Inductor Value (from 330 nH Recommended) on Regulator Performance**

$I_{MAX(Load)}$	$\Delta V_{OUT}$ (Eq.(7))	Transient Response
Increase	Decrease	Degraded

### Inductor Current Rating

The current-limit circuit can allow substantial peak currents to flow through  $L1$  under worst-case conditions. If it is possible for the load to draw such currents, the inductor should be capable of sustaining the current or failing in a safe manner.

For space-constrained applications, a lower current rating for  $L1$  can be used. The FAN53526 may still protect these inductors in the event of a short circuit, but may not be able to protect the inductor from failure if the load is able to draw higher currents than the DC rating of the inductor. Refer to Table 2 for the recommended inductors.

### Output Capacitor and $V_{OUT}$ Ripple

If space is at a premium, 0603 capacitors may be used.

Increasing  $C_{OUT}$  has negligible effect on loop stability and can be increased to reduce output voltage ripple or to improve transient response. Output voltage ripple,  $\Delta V_{OUT}$ , is calculated by:

$$\Delta V_{OUT} = \Delta I_L \left[ \frac{f_{SW} \cdot C_{OUT} \cdot ESR^2}{2 \cdot D \cdot (1-D)} + \frac{1}{8 \cdot f_{SW} \cdot C_{OUT}} \right] \quad (6)$$

where  $C_{OUT}$  is the effective output capacitance.

The capacitance of  $C_{OUT}$  decreases at higher output voltages, which results in higher  $\Delta V_{OUT}$ . Equation (6) is only valid for CCM operation, which occurs in PWM Mode.

The FAN53526 can be used with either  $2 \times 22$   $\mu$ F (0603) or  $2 \times 47$   $\mu$ F (0603) output capacitor configuration. If a tighter ripple and transient specification is needed from the FAN53526, then the  $2 \times 47$   $\mu$ F is recommended.

The lowest  $\Delta V_{OUT}$  is obtained when the IC is in PWM Mode and, therefore, operating at 2.4 MHz. In PFM Mode,  $f_{SW}$  is reduced, causing  $\Delta V_{OUT}$  to increase.

### ESL Effects

The Equivalent Series Inductance (ESL) of the output capacitor network should be kept low to minimize the square-wave component of output ripple that results from the division ratio  $C_{OUT}$  ESL and the output inductor ( $L_{OUT}$ ). The square-wave component due to the ESL can be estimated as:

$$\Delta V_{OUT(SQ)} \approx V_{IN} \cdot \frac{ESL_{COUT}}{L1} \quad (7)$$

A good practice to minimize this ripple is to use multiple output capacitors to achieve the desired  $C_{OUT}$  value. For example, to obtain  $C_{OUT}=20$   $\mu$ F, a single 22  $\mu$ F 0805 would produce twice the square wave ripple as two  $10$   $\mu$ F 0805.

To minimize ESL, try to use capacitors with the lowest ratio of length to width. 0805s have lower ESL than 1206s. If low output ripple is a chief concern, some vendors produce 0508 capacitors with ultra-low ESL. Placing additional small-value capacitors near the load also reduces the high-frequency ripple components.

### Input Capacitor

The ceramic input capacitors should be placed as close as possible between the  $V_{IN}$  and PGND pins to minimize the parasitic inductance. If a long wire is used to bring power to the IC, additional "bulk" capacitance (electrolytic or tantalum) should be placed between  $C_{IN}$  and the power source lead to reduce under-damped ringing that can occur between the inductance of the power source leads and  $C_{IN}$ .

The effective  $C_{IN}$  capacitance value decreases as  $V_{IN}$  increases due to DC bias effects. This has no significant impact on regulator performance.

## Thermal Considerations

Heat is removed from the IC through the solder bumps to the PCB copper. The junction-to-ambient thermal resistance ( $\theta_{JA}$ ) is largely a function of the PCB layout (size, copper weight, and trace width) and the temperature rise from junction to ambient ( $\Delta T$ ).

For the FAN53526,  $\theta_{JA}$  is 42°C/W when mounted on its four-layer with vias evaluation board in still air with 2 oz. outer layer copper weight and 1 oz. inner layer.

For long-term reliable operation, the junction temperature ( $T_J$ ) should be maintained below 125°C.

To calculate maximum operating temperature (<125°C) for a specific application:

1. Use efficiency graphs to determine efficiency for the desired  $V_{IN}$ ,  $V_{OUT}$ , and load conditions.
2. Calculate total power dissipation using:

$$P_T = V_{OUT} \times I_{LOAD} \times \left( \frac{1}{\eta} - 1 \right) \quad (8)$$

where  $\eta$  is efficiency from Figure 6 through Figure 7

3. Estimate inductor copper losses using:

$$P_L = I_{LOAD}^2 \times DCR_L \quad (9)$$

4. Determine IC losses by removing inductor losses (step 3) from total dissipation:

$$P_{IC} = P_T - P_L \quad (10)$$

5. Determine device operating temperature:

$$\Delta T = P_{IC} \times \theta_{JA} \quad T_{IC} = T_A + \Delta T \quad (11)$$

and

Note that the  $R_{DS(ON)}$  of the power MOSFETs increases linearly with temperature at about 1.4%/°C. This causes the efficiency ( $\eta$ ) to degrade with increasing die temperature.

### Layout Recommendations

1. The input capacitor ( $C_{IN}$ ) should be connected as close as possible to the VIN and GND pins. Connect to VIN and GND using only top metal. Do not route through vias (see Figure 26).
2. Place the inductor (L) as close as possible to the IC. Use short wide traces for the main current paths.

3. The output capacitor ( $C_{OUT}$ ) should be as close as possible to the IC. Connection to GND should only be on top metal. Feedback signal connection to VOUT should be routed away from noisy components and traces (e.g. SW line) (see Figure 28).

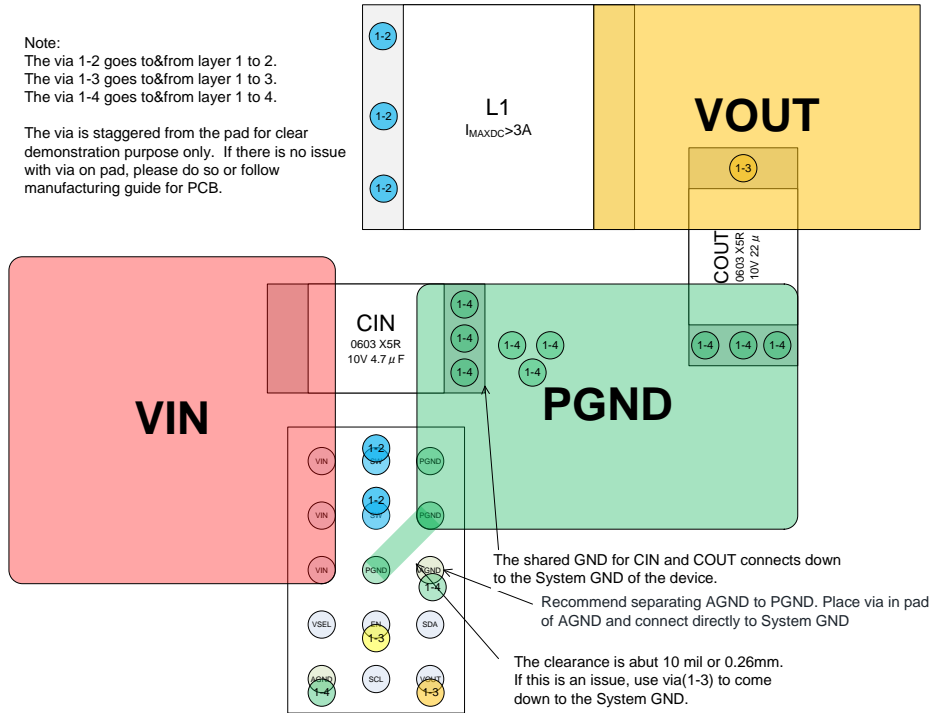

Figure 25. Guidance for Layer 1

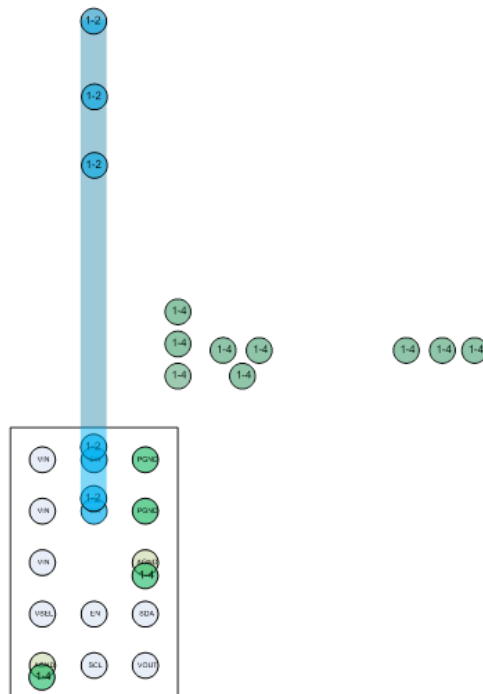

Figure 26. Layer 2

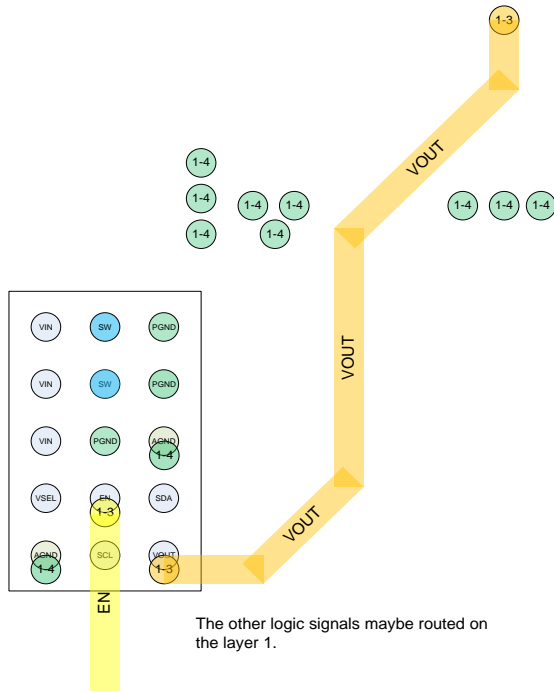

Figure 27. Layer 3

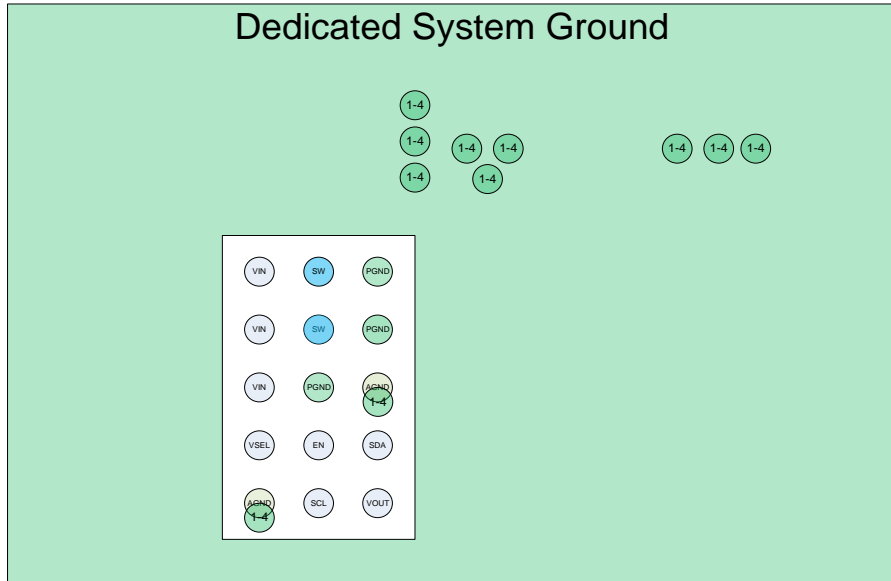
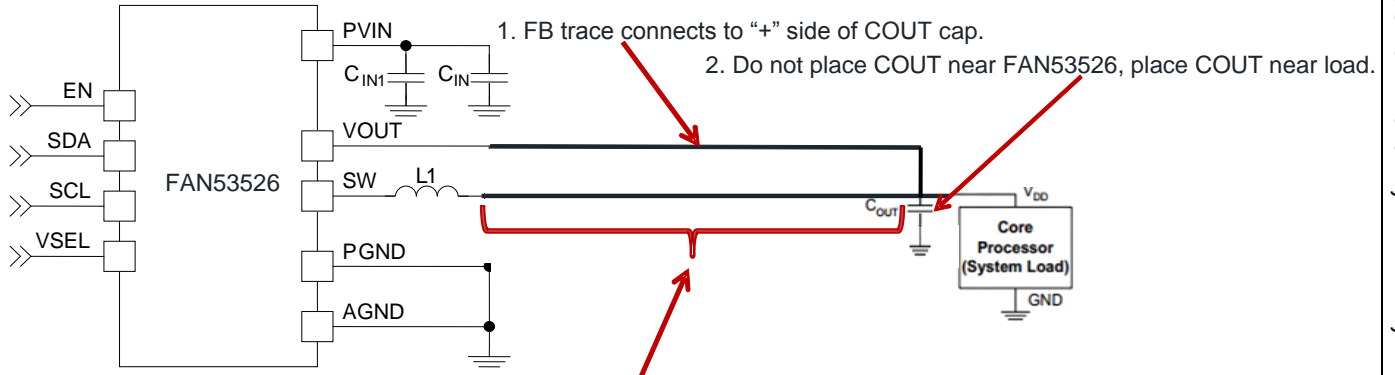

Figure 28. Layer 4



3. Maximum trace resistance between the inductor and the load should not exceed 30mΩ.  
 For a 20mils wide PCB trace with 0.5mils thickness using 2oz. copper, a length of 0.5 inches gives a resistance of 24.3mΩ.

**Figure 29. Remote Sensing Schematic**

### Physical Dimensions

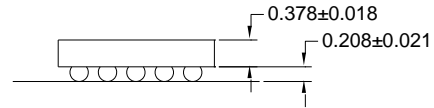
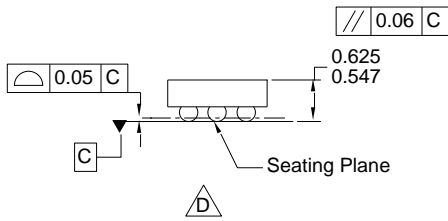
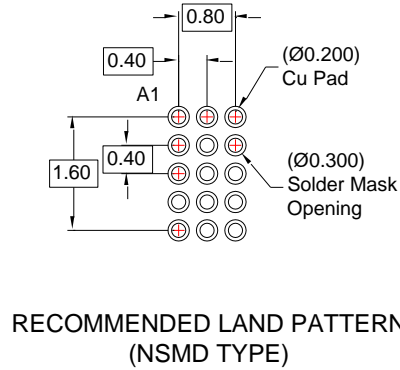
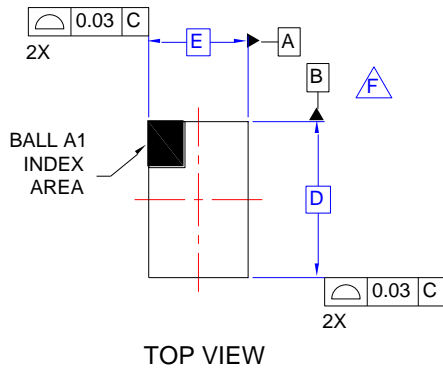

SIDE VIEWS

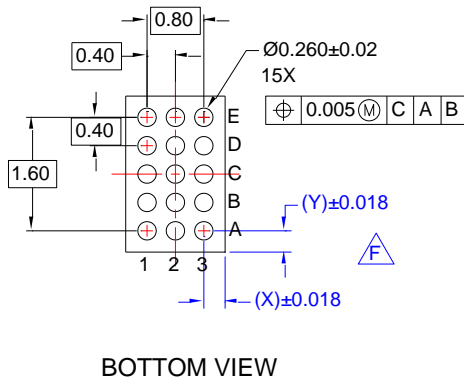

#### NOTES

- A. NO JEDEC REGISTRATION APPLIES.
- B. DIMENSIONS ARE IN MILLIMETERS.
- C. DIMENSIONS AND TOLERANCE PER ASME Y14.5 - 2009.
- D. DATUM C IS DEFINED BY THE SPHERICAL CROWNS OF THE BALLS.
- E. PACKAGE NOMINAL HEIGHT IS 586 ± 39 MICRONS (547-625 MICRONS).
- F. FOR DIMENSIONS D,E,X, AND Y SEE PRODUCT DATASHEET.
- G. DRAWING FILNAME: MKT-UC015AB Rev1

BOTTOM VIEW

Figure 30. 15-Ball, Wafer-Level Chip-Scale Package (WLCSP), 3x5 Array, 0.4 mm Pitch, 250 µm Ball

### Product-Specific Dimensions

D	E	X	Y
2.015 ± 0.03 mm	1.310 ± 0.03 mm	0.255 mm	0.2075 mm

ON Semiconductor and the ON Semiconductor logo are trademarks of Semiconductor Components Industries, LLC dba ON Semiconductor or its subsidiaries in the United States and/or other countries. ON Semiconductor owns the rights to a number of patents, trademarks, copyrights, trade secrets, and other intellectual property. A listing of ON Semiconductor's product/patent coverage may be accessed at [www.onsemi.com/site/pdf/Patent-Marking.pdf](http://www.onsemi.com/site/pdf/Patent-Marking.pdf). ON Semiconductor reserves the right to make changes without further notice to any products herein. ON Semiconductor makes no warranty, representation or guarantee regarding the suitability of its products for any particular purpose, nor does ON Semiconductor assume any liability arising out of the application or use of any product or circuit, and specifically disclaims any and all liability, including without limitation special, consequential or incidental damages. Buyer is responsible for its products and applications using ON Semiconductor products, including compliance with all laws, regulations and safety requirements or standards, regardless of any support or applications information provided by ON Semiconductor. "Typical" parameters which may be provided in ON Semiconductor data sheets and/or specifications can and do vary in different applications and actual performance may vary over time. All operating parameters, including "Typicals" must be validated for each customer application by customer's technical experts. ON Semiconductor does not convey any license under its patent rights nor the rights of others. ON Semiconductor products are not designed, intended, or authorized for use as a critical component in life support systems or any FDA Class 3 medical devices or medical devices with a same or similar classification in a foreign jurisdiction or any devices intended for implantation in the human body. Should Buyer purchase or use ON Semiconductor products for any such unintended or unauthorized application, Buyer shall indemnify and hold ON Semiconductor and its officers, employees, subsidiaries, affiliates, and distributors harmless against all claims, costs, damages, and expenses, and reasonable attorney fees arising out of, directly or indirectly, any claim of personal injury or death associated with such unintended or unauthorized use, even if such claim alleges that ON Semiconductor was negligent regarding the design or manufacture of the part. ON Semiconductor is an Equal Opportunity/Affirmative Action Employer. This literature is subject to all applicable copyright laws and is not for resale in any manner.

**PUBLICATION ORDERING INFORMATION**

**LITERATURE FULFILLMENT:**

Literature Distribution Center for ON Semiconductor  
 19521 E. 32nd Pkwy, Aurora, Colorado 80011 USA  
**Phone:** 303-675-2175 or 800-344-3860 Toll Free USA/Canada  
**Fax:** 303-675-2176 or 800-344-3867 Toll Free USA/Canada  
**Email:** [orderlit@onsemi.com](mailto:orderlit@onsemi.com)

**N. American Technical Support:** 800-282-9855 Toll Free  
 USA/Canada.  
**Europe, Middle East and Africa Technical Support:**  
 Phone: 421 33 790 2910  
**Japan Customer Focus Center**  
 Phone: 81-3-5817-1050

**ON Semiconductor Website:** [www.onsemi.com](http://www.onsemi.com)  
**Order Literature:** <http://www.onsemi.com/orderlit>  
 For additional information, please contact your local  
 Sales Representative



ON Semiconductor and  are trademarks of Semiconductor Components Industries, LLC dba ON Semiconductor or its subsidiaries in the United States and/or other countries. ON Semiconductor owns the rights to a number of patents, trademarks, copyrights, trade secrets, and other intellectual property. A listing of ON Semiconductor's product/patent coverage may be accessed at [www.onsemi.com/site/pdf/Patent-Marking.pdf](http://www.onsemi.com/site/pdf/Patent-Marking.pdf). ON Semiconductor reserves the right to make changes without further notice to any products herein. ON Semiconductor makes no warranty, representation or guarantee regarding the suitability of its products for any particular purpose, nor does ON Semiconductor assume any liability arising out of the application or use of any product or circuit, and specifically disclaims any and all liability, including without limitation special, consequential or incidental damages. Buyer is responsible for its products and applications using ON Semiconductor products, including compliance with all laws, regulations and safety requirements or standards, regardless of any support or applications information provided by ON Semiconductor. "Typical" parameters which may be provided in ON Semiconductor data sheets and/or specifications can and do vary in different applications and actual performance may vary over time. All operating parameters, including "Typicals" must be validated for each customer application by customer's technical experts. ON Semiconductor does not convey any license under its patent rights nor the rights of others. ON Semiconductor products are not designed, intended, or authorized for use as a critical component in life support systems or any FDA Class 3 medical devices or medical devices with a same or similar classification in a foreign jurisdiction or any devices intended for implantation in the human body. Should Buyer purchase or use ON Semiconductor products for any such unintended or unauthorized application, Buyer shall indemnify and hold ON Semiconductor and its officers, employees, subsidiaries, affiliates, and distributors harmless against all claims, costs, damages, and expenses, and reasonable attorney fees arising out of, directly or indirectly, any claim of personal injury or death associated with such unintended or unauthorized use, even if such claim alleges that ON Semiconductor was negligent regarding the design or manufacture of the part. ON Semiconductor is an Equal Opportunity/Affirmative Action Employer. This literature is subject to all applicable copyright laws and is not for resale in any manner.

## PUBLICATION ORDERING INFORMATION

### LITERATURE FULFILLMENT:

Literature Distribution Center for ON Semiconductor  
19521 E. 32nd Pkwy, Aurora, Colorado 80011 USA  
**Phone:** 303-675-2175 or 800-344-3860 Toll Free USA/Canada  
**Fax:** 303-675-2176 or 800-344-3867 Toll Free USA/Canada  
**Email:** [orderlit@onsemi.com](mailto:orderlit@onsemi.com)

**N. American Technical Support:** 800-282-9855 Toll Free  
USA/Canada  
**Europe, Middle East and Africa Technical Support:**  
Phone: 421 33 790 2910  
**Japan Customer Focus Center**  
Phone: 81-3-5817-1050

**ON Semiconductor Website:** [www.onsemi.com](http://www.onsemi.com)  
**Order Literature:** <http://www.onsemi.com/orderlit>  
For additional information, please contact your local  
Sales Representative

# Mouser Electronics

Authorized Distributor

Click to View Pricing, Inventory, Delivery & Lifecycle Information:

## ON Semiconductor:

[FAN53526UC128X](#) [FAN53526UC89X](#) [FAN53526UC106X](#) [FAN53526UC84X](#) [FAN53526UC100X](#) [FAN53526UC00X](#)  
[FAN53526UC106X\\_F065](#) [FAN53526UC89X\\_F065](#)

Компания «Океан Электроники» предлагает заключение долгосрочных отношений при поставках импортных электронных компонентов на взаимовыгодных условиях!

Наши преимущества:

- Поставка оригинальных импортных электронных компонентов напрямую с производств Америки, Европы и Азии, а так же с крупнейших складов мира;
- Широкая линейка поставок активных и пассивных импортных электронных компонентов (более 30 млн. наименований);
- Поставка сложных, дефицитных, либо снятых с производства позиций;
- Оперативные сроки поставки под заказ (от 5 рабочих дней);
- Экспресс доставка в любую точку России;
- Помощь Конструкторского Отдела и консультации квалифицированных инженеров;
- Техническая поддержка проекта, помощь в подборе аналогов, поставка прототипов;
- Поставка электронных компонентов под контролем ВП;
- Система менеджмента качества сертифицирована по Международному стандарту ISO 9001;
- При необходимости вся продукция военного и аэрокосмического назначения проходит испытания и сертификацию в лаборатории (по согласованию с заказчиком);
- Поставка специализированных компонентов военного и аэрокосмического уровня качества (Xilinx, Altera, Analog Devices, Intersil, Interpoint, Microsemi, Actel, Aeroflex, Peregrine, VPT, Syfer, Eurofarad, Texas Instruments, MS Kennedy, Miteq, Cobham, E2V, MA-COM, Hittite, Mini-Circuits, General Dynamics и др.);

Компания «Океан Электроники» является официальным дистрибьютором и эксклюзивным представителем в России одного из крупнейших производителей разъемов военного и аэрокосмического назначения «JONHON», а так же официальным дистрибьютором и эксклюзивным представителем в России производителя высокотехнологичных и надежных решений для передачи СВЧ сигналов «FORSTAR».



## JONHON

«JONHON» (основан в 1970 г.)

Разъемы специального, военного и аэрокосмического назначения:

(Применяются в военной, авиационной, аэрокосмической, морской, железнодорожной, горно- и нефтедобывающей отраслях промышленности)

«FORSTAR» (основан в 1998 г.)

ВЧ соединители, коаксиальные кабели, кабельные сборки и микроволновые компоненты:

(Применяются в телекоммуникациях гражданского и специального назначения, в средствах связи, РЛС, а так же военной, авиационной и аэрокосмической отраслях промышленности).



Телефон: 8 (812) 309-75-97 (многоканальный)

Факс: 8 (812) 320-03-32

Электронная почта: [ocean@oceanchips.ru](mailto:ocean@oceanchips.ru)

Web: <http://oceanchips.ru/>

Адрес: 198099, г. Санкт-Петербург, ул. Калинина, д. 2, корп. 4, лит. А