

Power Line Filters

Compact design requires minimal real estate and delivers excellent filtering characteristics for both differential and common mode. RoHS compliant, easily installed for a broad array of applications.



Appliance Filters	PF50-PF53
Single Stage.....	PF54-PF69
With Wire Leads	PF56-PF57
With Wire Leads for Medical Applications	PF58-PF59
Higher Current	PF66-PF69
DC – Higher Current	PF70-PF71
Dual Stage.....	PF72-PF79

Power Line Filters Appliance Filters



11-MPC Series

Features

- Miniature general purpose PCB mounted filter
- Requires minimal PCB real estate space
- Low cost
- Operating temperature: -25°C to +70°C
- Two forms of cases are available: metal case and plastic case

Applications

- Personal computers and peripherals
- Digital equipment
- Measuring instruments and medical equipment
- TV & VCR monitors and display units
- Home appliances

Circuit Diagram

Circuit 1



Circuit 2



Circuit 3



Circuit 4

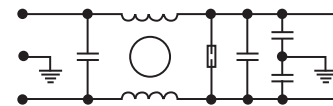

Specifications

Model	Rated Voltage (@ 50/60Hz)	Rated Current	Leakage Current (Max.)	Circuit Diagram	Figure	Temperature Rise (Max.)
11-MPC-001-2-B	120/250VAC	1A	0.50mA	1	A1	30°C
11-MPC-001-5-A				A		
11-MPC-001-5-B		2A		A1		
11-MPC-002-5-B				D		
11-MPC-002-5-D		3A		E		
11-MPC-003-5-E		6A		A1		
11-MPC-006-5-B				C		
11-MPC-006-5-C		16A		0.2mA	4	
11-MPC-016-5-B						

Note: Test voltage: 1500VAC one minute, line to ground
 Insulation resistance: 300 Mohm min. at 500VDC
 Voltage drop: 1V max. at rated current
 Weight: 17.5g

PCB Power Filters Miniature Printed Circuit Board

11-MPC Series

Figure A



Figure A1

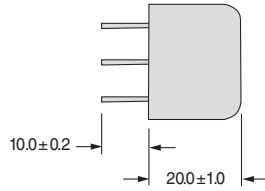

Figure B



Figure C

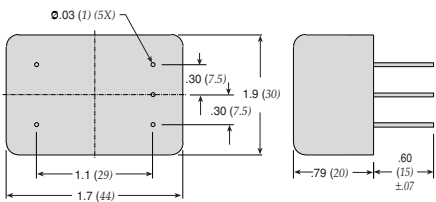

Figure D

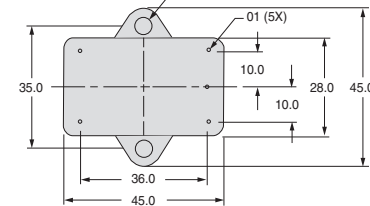
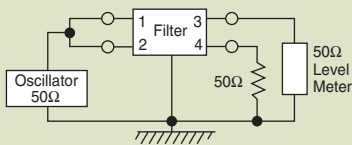

Figure E



Dimensions in inches (mm)

Common Mode



11-MPC-001;-002

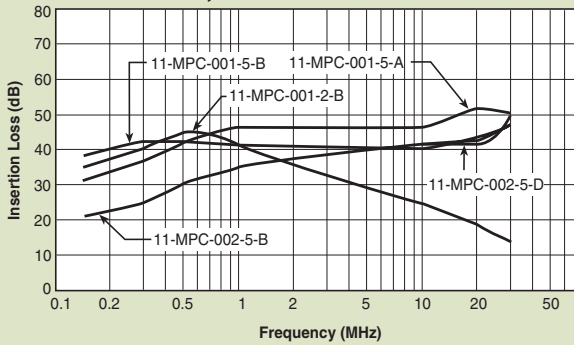

11-MPC-003;-006;-016

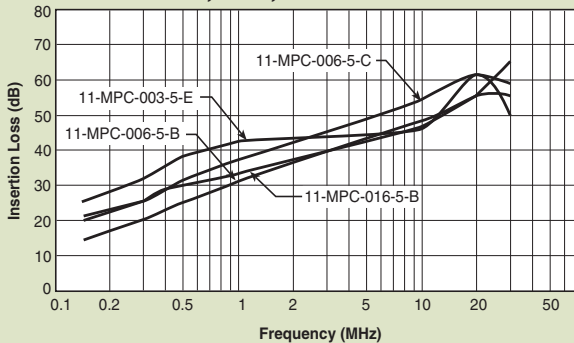

Normal Mode



11-MPC-001;-002



11-MPC-003;-006;-016



Power Line Filters Appliance Filters

62-AL/62-AC Series



Tested and found to be
IAW VDE 0565 Part 3

Features

- Low-cost plastic case
- Compact design requires minimal real estate space
- Suitable for products that must conform to FCC regulations
- Wide variety of circuit and filtering options
- Good filtering characteristics for both normal mode and common mode
- Epoxy molded for reliability
- Operating temperature: -25°C to +85°C (including temperature rise, see graph on page PF53)

Applications

- Personal computers and peripherals
- Digital equipment
- Industrial equipment
- Vending machines
- Home appliances
- Office equipment

Specifications

Model*	Rated Voltage (@ 50/60Hz)	Rated Current	Leakage Current (Max.)	Capacitance		Inductance (L ₁)	Temperature Rise (Max.)
				C _Y	C _X		
62-AFL-010-3-11	250VAC	1.0A	0.35mA	2200pF	0.1uF	11.0mH	40°C
62-AFC-010-3-11			0.50mA	3300pF			
62-AFL-010-5-11			0.35mA	2200pF			
62-AFC-010-5-11				3300pF			
62-AFL-016-3-11		1.6A	0.35mA	2200pF		6.0mH	
62-AFC-016-3-11				3300pF			
62-AFL-016-5-11		0.35mA	0.50mA	2200pF		2.4mH	
62-AFC-016-5-11				3300pF			
62-AFL-030-3-11		3.0A	0.35mA	2200pF		1.0mH	
62-AFC-030-3-11				3300pF			
62-AFL-030-5-11		0.35mA	0.50mA	2200pF		0.53mH	
62-AFC-030-5-11				3300pF			
62-AFL-045-3-11		4.5A	0.35mA	2200pF		0.53mH	
62-AFC-045-3-11				3300pF			
62-AFL-045-5-11		0.35mA	0.50mA	2200pF		0.53mH	
62-AFC-045-5-11				3300pF			
62-AFL-060-3-11		6.0A	0.35mA	2200pF		0.53mH	
62-AFC-060-3-11				3300pF			
62-AFL-060-5-11		0.35mA	0.50mA	2200pF		0.53mH	
62-AFC-060-5-11				3300pF			

Note: All types are designed to meet the requirement of UL 1283, CSA 22.2. VDE 0565-3
 Test voltage: 1500VAC one minute, line to ground
 Insulation resistance: 300 Mohm min. at 500VDC
 Voltage drop: 1V max.

* Available with bleeder resistor
 Replace F with R for part number



Circuit Diagrams

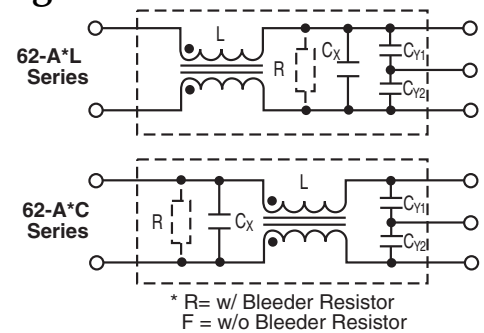

Power Line Filters Appliance Filters

62-AL/62-AC Series

Common Mode

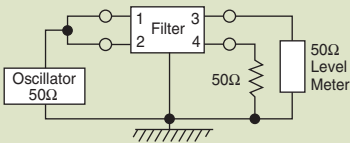

62-AFL-xxx-3-11



62-AFC-xxx-3-11

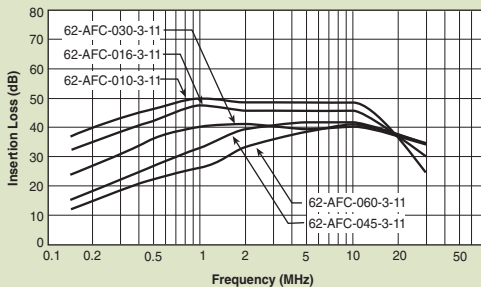

62-AFL-xxx-5-11



62-AFC-xxx-5-11



Temperature Characteristics



Normal Mode



62-AFL-XXX-3-11



62-AFC-XXX-3-11

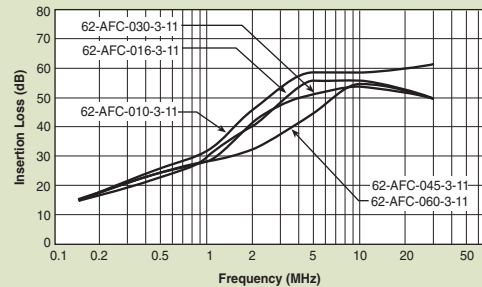

62-AFL-xxx-5-11



62-AFC-xxx-5-11



Power Line Filters Single Stage

62-PPF/PQF/PRF Series



Tested and found to be
IAW VDE 0565 Part 3

Features

- Low-cost plastic case
- Compact design requires minimal real estate space
- Suitable for products that must conform to FCC and FTZ regulations
- Wide variety of circuit and filtering options
- Good filtering characteristics for both normal mode and common mode
- Epoxy molded for reliability
- Operating temperature: -25°C to +85°C (including temperature rise, see graph on page PF55)

Applications

- Personal computers and peripherals
- Digital equipment
- Industrial equipment
- Vending machines
- Office equipment



Circuit Diagrams



* Bleeder Resistor is available only for
62-P(Q/R/P)F-XXX-X-12

Specifications

Model	Rated Voltage (@ 50/60Hz)	Rated Current	Leakage Current (Max.)	Capacitance		Inductance (L ₁)	Temperature Rise (Max.)	
				C _Y	C _X			
62-PQF-020-5-11	250VAC	2A	0.50mA	3300pF	0.1uF	15mH	30°C	
62-PQF-020-5-12					.22uF			
62-PPF-020-5-11					0.1uF			
62-PPF-020-5-12					.22uF			
62-PQF-030-5-11					0.1uF			8mH
62-PQF-030-5-12					.22uF			
62-PPF-030-5-11		0.1uF						
62-PPF-030-5-12		.22uF						
62-PQF-060-5-11		0.1uF			2.1mH			
62-PQF-060-5-12		.22uF						
62-PPF-060-5-11		0.1uF						
62-PPF-060-5-12		.22uF						
62-PRF-010-5-11		0.1uF			486uH			
62-PRF-010-5-12		.22uF						
62-PRF-020-5-11		0.1uF			181uH			
62-PRF-020-5-12		.22uF						
62-PRF-030-5-11		0.1uF			97uH			
62-PRF-030-5-12		.22uF						

Note: All types are designed to meet the requirement of UL 1283, CSA 22.2, VDE 0565-3

Test voltage: 1500VAC one minute, line to ground
 Insulation resistance: 300 Mohm min. at 500VDC
 Voltage drop: 1V max. (except 62-PRF-010-5-11) at rated current
 62-PRF-010-5-11: 1.5V max. at rated current
 Weight: 62-PPF & PQF Series: 2.11 ounces (60 grams)
 62-PRF Series: 1.76 ounces (50 grams)

Power Line Filters Single Stage

62-PPF/PQF/PRF Series

Temperature Characteristics



Also available with .250 Fast-ons

Dimensions in inches (mm)

Normal Mode



62-PQF Series



62-PPF Series



Common Mode



62-P(Q/R)F Series



62-PRF Series



Power Line Filters Single Stage Wire Leads

62-PML Series

Features

- Compact design requires minimal real estate space
- Suitable for products that must conform to FCC and FTZ regulations
- Excellent attenuation for high voltage impulse
- Metal case provides effective shielding
- Excellent filtering characteristics for both normal mode and common mode
- Structure provides effective shielding for noise generated externally and internally
- Operating temperature: -25°C to +85°C (including temperature rise, see graph on page PF57)

Applications

- Digital equipment
- Personal computers and peripherals
- Measuring instruments
- Medical equipment
- Factory automation equipment



Tested and found to be
IAW VDE 0565 Part 3



Circuit Diagram



Specifications

Model	Rated Voltage (@ 50/60Hz)	Rated Current	Leakage Current (Max.)	Capacitance		Inductance (L ₁)	Temperature Rise (Max.)
				C _Y	C _X		
62-PML-015-3-11	250VAC	1.5A	0.35mA	0.1µF	3300pF	10.0mH	30°C
62-PML-015-5-11			0.50mA				
62-PML-030-3-11		3A	0.35mA			2.4mH	
62-PML-030-5-11			0.50mA				
62-PML-050-3-11		5A	0.35mA			3300pF	
62-PML-050-5-11			0.50mA				

Note: All types are designed to meet the requirement of UL 1283, CSA 22.2. VDE 0565-3
 Test voltage: 1500VAC one minute, line to ground
 Insulation resistance: 300 Mohm min. at 500VDC
 Voltage drop: 1V max. at rated current
 Weight: 62-PML-015 Series: 3.06 ounces (87 grams)
 62-PML-030 Series: 3.17 ounces (90 grams)
 62-PML-050 Series: 3.28 ounces (93 grams)
 Discharge time: 0.4 sec. max.

Power Line Filters Single Stage Wire Leads

62-PML Series

Temperature Characteristics



* Custom lengths available upon request. Dimensions in inches (mm)

Common Mode

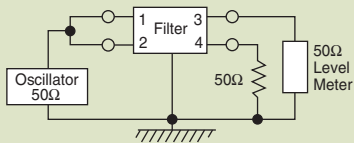

Normal Mode

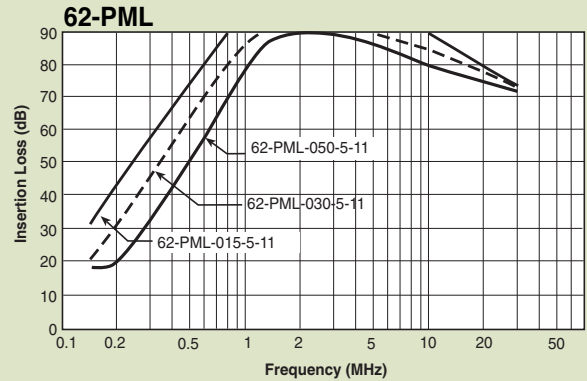

Power Line Filters Single Stage Wire Leads

for Medical Purpose Applications

12-PML & 12-PMF Series



Features

- Compact design requires minimal real estate space
- Suitable for products that must conform to FCC and FTZ regulations
- Excellent attenuation for high voltage impulse
- Metal case provides effective shielding
- Excellent filtering characteristics for both normal mode and common mode
- Structure provides effective shielding for noise generated externally and internally
- Operating temperature: -25°C to +70°C
- Low leakage current

Applications

- Digital equipment
- Personal computers and peripherals
- Measuring instruments
- Medical equipment
- Factory automation equipment



Circuit Diagram

Circuit 1

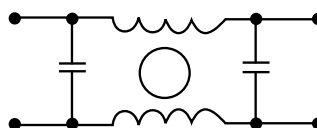

Circuit 2

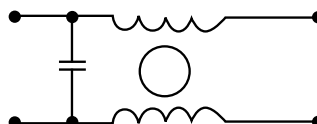

Specifications

Model	Rated Voltage (@ 50/60Hz)	Rated Current	Leakage Current (Max.)	Circuit Diagram	Figure	Temperature Rise (Max.)
12-PML-001-2-A	120/250VAC	1A	5uA	1	A	30°C
12-PML-002-2-A		2A				
12-PML-006-2-A		6A				
12-PML-010-2-A		10A		2	B	
12-PMF-001-2-B		1A				
12-PMF-002-2-B		2A				
12-PMF-006-2-B		6A		1	C	
12-PML-001-2-C		1A				

Note: All types are designed to meet the requirement of UL 1283, CSA 22.2. VDE 0565-3
 Test voltage: 1500VAC one minute, line to ground
 Insulation resistance: 300 Mohm min. at 500VDC
 Voltage drop: 1V max. at rated current
 Discharge time: 0.4 sec. max.

Power Line Filters Single Stage Wire Leads

for Medical Purpose Applications

12-PML & 12-PMF Series

Figure A

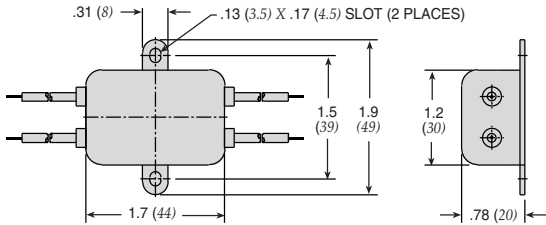
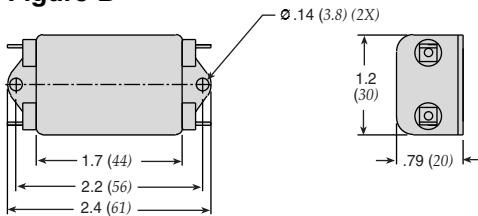

Figure C

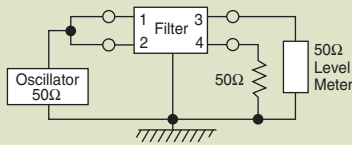

Figure B



Dimensions in inches (mm)

Common Mode



12-PML-001;-002;-006;-010



12-PMF-001;-002;-006;-010



Normal Mode

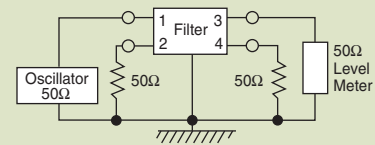

12-PML-001;-002;-006;-010

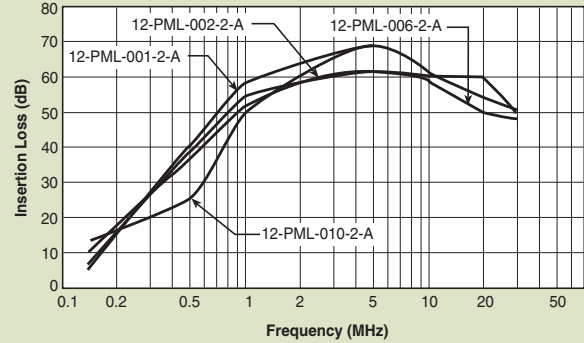

12-PMF-001;-002;-006;-010

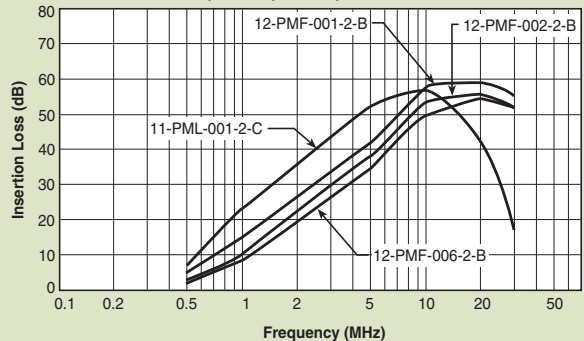

Power Line Filters Single Stage



62-LMF & LMB Series



Tested and found to be
IAW VDE 0565 Part 3

Features

- Space saving, compact designs
- Suitable for products that must conform to FCC and FTZ regulations
- Excellent filtering characteristics for both normal mode and common mode
- Structure provides effective shielding for noise generated externally and internally
- Metal case provides effective shielding
- Rugged construction
- Operating temperature: -25°C to +85°C (including temperature rise, see graph on page PF61)

Applications

- Digital equipment
- Office automation equipment, such as copy and fax machines
- Computers and peripherals
- Instrumentation and controls

Circuit Diagram



Specifications

Model*	Rated Voltage (@ 50/60Hz)	Rated Current	Leakage Current (Max.)	Capacitance		Inductance (L ₁)	Temperature Rise (Max.)	
				C _Y	C _X			
62-LMB-030-5-11	250VAC	3A	0.50mA	3300pF	0.1uF	14mH	45°C	
62-LMF-030-5-11		5A			0.1uF & .22uF	7.0mH		
62-LMB-050-5-11					8A	.22uF		4.2mH
62-LMF-050-5-11		10A				.33uF		2.2mH
62-LMB-080-5-11					.33uF	2.2mH		2.2mH
62-LMF-080-5-11								
62-LMB-100-5-11					.33uF	2.2mH		2.2mH
62-LMF-100-5-11		.33uF						

Note: Test voltage: 1500VAC one minute, line to ground
Insulation resistance: 300 Mohm min. at 500VDC
Voltage drop: 1V max. at rated current
Discharge time: 0.4 sec. max.
Weight: 5.3 ounces (150 grams)

*62-LMF - designates Fast-on terminals
62-LMB - designates Bolt-in terminals
62-LML - wire lead in/outputs also available

Power Line Filters Single Stage

62-LMF & LMB Series

Temperature Characteristics



62-LMB



62-LMF



Dimensions in inches (mm)

Common Mode



Normal Mode



62-LMF & LMB



62-LMF & LMB



Power Line Filters Single Stage

62-PMF & PMB Series



Tested and found to be
IAW VDE 0565 Part 3

Features

- Space-saving, compact designs
- Suitable for products that must conform to FCC regulations
- Excellent attenuation for high voltage impulse
- Metal case provides effective EMI shielding
- Excellent filtering characteristics for both normal mode and common mode
- Epoxy molded for internal component reliability
- Structure provides effective shielding for noise generated externally and internally
- Operating temperature: -25°C to +85°C (including temperature rise, see graph on page PF63)

Applications

- Digital equipment
- Computers and peripherals
- Measuring instruments
- Medical equipment
- Equipment requiring very high impulse attenuation
- Factory automation equipment
- Industrial equipment such as UPS, inverters and converters
- Telecommunications equipment
- Office automation equipment, such as copy and fax machines



Circuit Diagram



Specifications

Model*	Rated Voltage (@ 50/60Hz)	Rated Current	Leakage Current (Max.)	Capacitance		Inductance (L ₁)	Temperature Rise (Max.)	
				C _Y	C _X			
62-PMB-050-5-11	250VAC	5A	0.50mA	3300pF	0.1uF	14mH	30°C	
62-PMF-050-5-11								
62-PMB-080-5-11								
62-PMF-080-5-11		8A			.1uF	7.0mH		
62-PMB-100-5-12								
62-PMF-100-5-12		10A			.22uF	4.2mH		
62-PMB-150-5-13								
62-PMF-150-5-13		15A			.33uF	2.2mH		35°C
62-PMB-200-5-13								
62-PMF-200-5-13	20A	1.8mH	1.8mH	45°C**				
62-PMF-200-5-13								

Note: Test voltage: 1500VAC one minute, line to ground
Insulation resistance: 300 Mohm min. at 500VDC
Voltage drop: 1V max.
Discharge time: 0.4 sec. max.
Weight: 8.82 ounces (250 grams)

* PMF - designates Fast-on terminals
PMB - designates Bolt-in terminals

** The temperature rise of 20 amp units can be decreased to 30°C by mounting on 200 X 200 x 1.0(mm) steel chassis

Power Line Filters Single Stage

62-PMF & PMB Series

Temperature Characteristics



62-PMF



62-PMB



MODEL	A	B	C
62-PMF/PMB-100-200	1.490 (38)	.944 (24)	.433 (11)
62-PMF/PMB-050-080	1.258 (32)	.786 (20)	0 (0)

Dimensions in inches (mm)

Common Mode

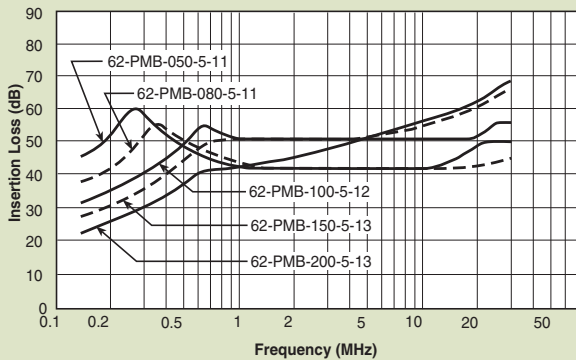
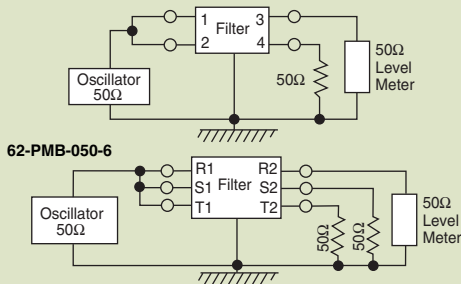

Normal Mode



Power Line Filters Single Stage

12-PMF Series



Features

- Space-saving, compact designs
- Suitable for products that must conform to FCC regulations
- Excellent attenuation for high voltage impulse
- Metal case provides effective EMI shielding
- Excellent filtering characteristics for both normal mode and common mode
- Epoxy molded for internal component reliability
- Structure provides effective shielding for noise generated externally and internally
- Operating temperature: -25°C to +85°C

Applications

- Digital equipment
- Computers and peripherals
- Measuring instruments
- Medical equipment
- Equipment requiring very high impulse attenuation
- Factory automation equipment
- Industrial equipment such as UPS, inverters and converters
- Telecommunications equipment
- Office automation equipment, such as copy and fax machines



Circuit Diagram

Circuit 1



Circuit 2



Circuit 3



Circuit 4



Circuit 5



Circuit 6



Specifications

Model	Rated Voltage (@ 50/60Hz)	Rated Current	Leakage Current (Max.)	Circuit Diagram	Figure	Temperature Rise (Max.)
12-PMF-001-5-A	120/250VAC	1A	0.5mA	1	A	30°C
12-PMF-002-5-B		2A		2	B	
12-PMF-003-5-A		3A		4	A	
12-PMF-003-5-B		2A		2	B	
12-PMF-006-5-A		6A		4	A	
12-PMF-006-5-C		1A		1	C	
12-PMF-006-5-D		6A		6	D	
12-PMF-010-5-A		10A		2	A	
12-PMF-010-5-C		3A		3	C	
12-PMF-015-5-C		15A		5	E	
12-PMF-015-5-E		C				
12-PMF-020-5-C		20A			D	
12-PMF-020-5-D		D				
12-PMF-020-5-E		E				

Note: Test voltage: 1500VAC one minute, line to ground
 Insulation resistance: 300 Mohm min. at 500VDC
 Voltage drop: 1V max.
 Discharge time: 0.4 sec. max.

Power Line Filters Single Stage

12-PMF Series

Figure A



Figure B



Figure C



Figure D



Figure E



Dimensions in inches (mm)

Common Mode



12-PMF-001;-002;-003;-006

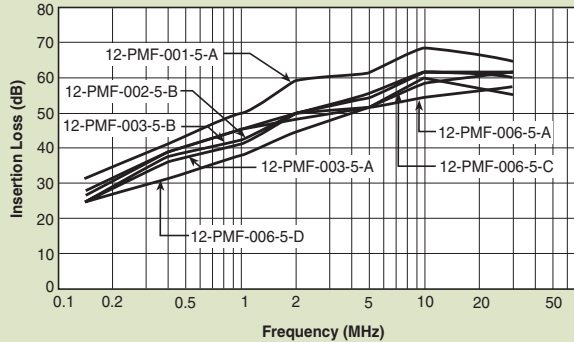

12-PMF-001;-002;-003;-006

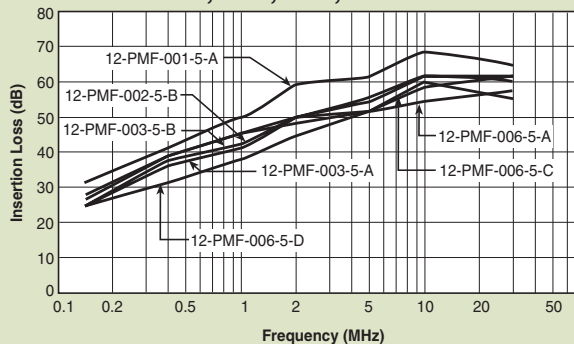

Normal Mode



12-PMF-001;-002;-003;-006



12-PMF-010;-015;-020

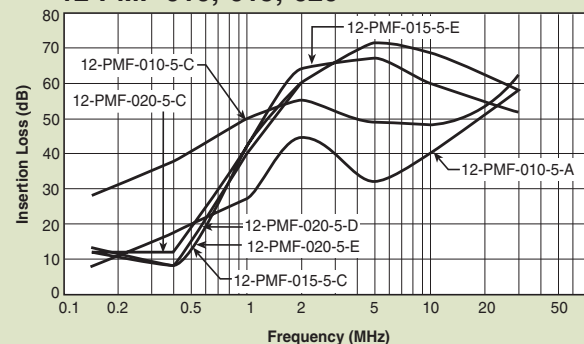

Power Line Filters Single Stage - Higher Current



62-PMB Series

Features

- Space-saving, compact designs
- Suitable for products that must conform to FCC regulations
- Excellent attenuation for high voltage impulse
- Metal case provides effective shielding
- Excellent filtering characteristics for both normal mode and common mode
- Epoxy molded for internal component reliability
- Structure provides effective shielding for noise generated externally and internally
- Safety agency approvals pending
- Designed to be in accordance with VDE 0565 Part 3
- Operating temperature: -25°C to +85°C (including temperature rise)

Applications

- Digital equipment
- Computers and peripherals
- Measuring instruments
- Medical equipment
- Equipment requiring very high impulse attenuation
- Factory automation equipment
- Industrial equipment such as UPS, inverters and converters
- Telecommunications equipment
- Office automation equipment, such as copy and fax machines

Circuit Diagram



Specifications

Model	Rated Voltage (@ 50/60Hz)	Rated Current	Leakage Current (Max.)	Capacitance		Inductance (L ₁)	Temperature Rise (Max.)
				C _Y	C _X		
62-PMB-300-5-14	250VAC	30A	0.50mA	3300pF	.47uF	1.6mH	45°C
62-PMB-400-5-14		40A				0.8mH	

Note: Test voltage: 1500VAC one minute, line to earth
 Insulation resistance: 300 Mohm min. at 500VDC
 Voltage drop: 1V max.
 Discharge time: 0.4 sec. max.
 Weight: 8.82 ounces (250 grams)

Power Line Filters Single Stage - Higher Current

62-PMB Series

62-PMB-300-5-14 and 62-PMB-400-5-14



Dimensions in inches (mm)

Normal Mode

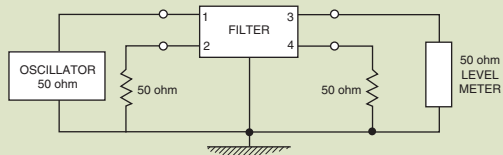

Common Mode

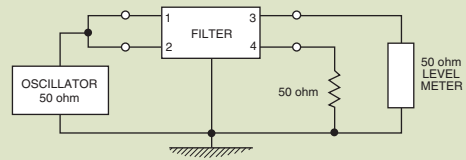

Power Line Filters Single Stage - Higher Current



12-PMB Series

Features

- Space-saving, compact designs
- Suitable for products that must conform to FCC regulations
- Excellent attenuation for high voltage impulse
- Metal case provides effective shielding
- Excellent filtering characteristics for both normal mode and common mode
- Epoxy molded for internal component reliability
- Structure provides effective shielding for noise generated externally and internally
- Designed to be in accordance with VDE 0565 Part 3
- Operating temperature: -25°C to +85°C

Applications

- Digital equipment
- Computers and peripherals
- Measuring instruments
- Medical equipment
- Equipment requiring very high impulse attenuation
- Factory automation equipment
- Industrial equipment such as UPS, inverters and converters
- Telecommunications equipment
- Office automation equipment, such as copy and fax machines

Circuit Diagram



Specifications

Model	Rated Voltage (@ 50/60Hz)	Rated Current	Leakage Current (Max.)	Circuit Diagram	Figure	Temperature Rise (Max.)
12-PMB-025-5-A	120/250VAC	25A	0.5mA	1	A	30°C
12-PMB-030-5-A		30A				
12-PMB-035-5-B		35A				
12-PMB-050-5-B		50A				
12-PMB-100-8-C		100A	1.0mA			
12-PMB-120-8-C		120A				

Note: Test voltage: 1500VAC one minute, line to earth
 Insulation resistance: 300 Mohm min. at 500VDC
 Voltage drop: 1V max.
 Discharge time: 0.4 sec. max.
 Weight: 8.82 ounces (250 grams)

Power Line Filters Single Stage - Higher Current

12-PMB Series

Figure A

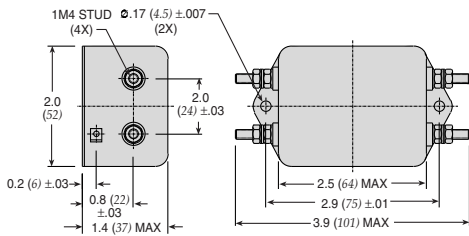

Figure B



Figure C



Dimensions in inches (mm)

Common Mode



12-PMB-025;-030;-035



12-PMB-050;-100;-120



Normal Mode



12-PMB-025;-030;-035



12-PMB-050;-100;-120



Power Line Filters DC - Higher Current



12-PMF & 12 PMB DC Series

Features

- Space-saving, compact designs
- Suitable for products that must conform to FCC regulations
- Excellent attenuation for high voltage impulse
- Metal case provides effective shielding
- Excellent filtering characteristics for both normal mode and common mode
- Epoxy molded for internal component reliability
- Structure provides effective shielding for noise generated externally and internally
- Designed to be in accordance with VDE 0565 Part 3
- Operating temperature: -40°C to +85°C

Applications

- Digital equipment
- Computers and peripherals
- Measuring instruments
- Equipment requiring very high impulse attenuation
- Factory automation equipment
- Industrial equipment such as UPS, inverters and converters
- Telecommunications equipment

Circuit Diagram



Specifications

Model	Rated Voltage (@ 50/60Hz)	Rated Current	Circuit Diagram	Figure	Temperature Rise (Max.)	
12-PMF-006-DC-C	48/250 VDC	6A	1	A	30°C	
12-PMF-010-DC-C		10A				
12-PMF-015-DC-C		15A				
12-PMF-020-DC-C		20A				
12-PMF-025-DC-D		25A		1		B
12-PMB-025-DC-F						
12-PMB-030-DC-F		30A		1		C
12-PMB-035-DC-F		35A				
12-PMB-040-DC-F		40A				
12-PMB-040-DC-B		50A		1		D
12-PMB-050-DC-B						
12-PMB-060-DC-B						
12-PMB-080-DC-G						
12-PMB-080-DC-C		80A		2		E
12-PMB-100-DC-C		100A	3	F		
12-PMB-120-DC-C						
12-PMB-140-DC-C						
12-PMB-180-DC-E						
12-PMB-200-DC-E		200A	2	G		
12-PMB-260-DC-E		260A				

Note: Test voltage: 1500VAC one minute, line to earth
Insulation resistance: 300 Mohm min. at 500VDC
Voltage drop: 1V max.

Discharge time: 0.4 sec. max.
Weight: 8.82 ounces (250 grams)

Power Line Filters DC - Higher Current

12-PMF & 12-PMB DC Series

Figure B



Figure C

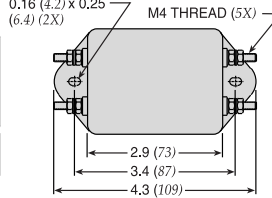

Figure A



Figure D

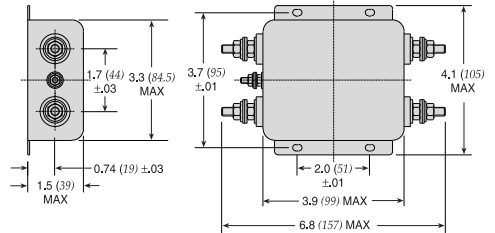

Figure E

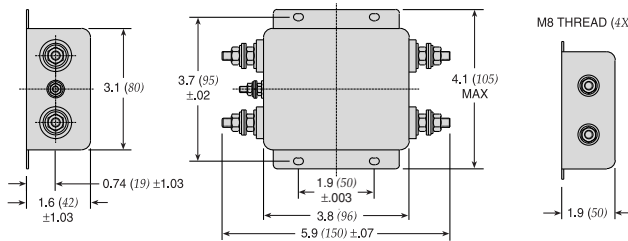
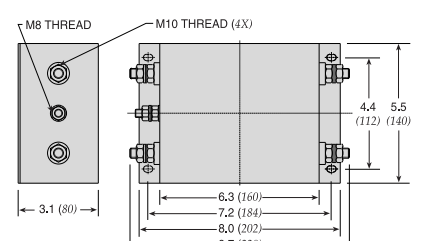

Figure F



Figure G



Dimensions in inches (mm)

Common Mode



12-PMF-006;-010;-015;-020;-025



12-PMB-025; thru -260



Normal Mode



12-PMF-006;-010;-015;-020;-025

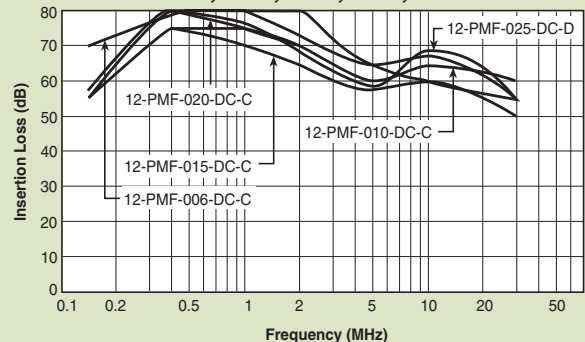

12-PMB-025; thru -260

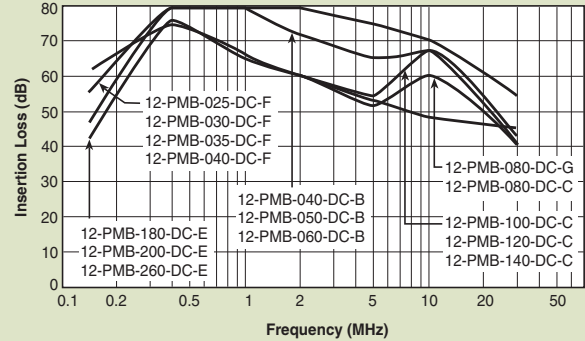

Power Line Filters Dual Stage



62-MMF Series

Features

- Suitable for products that must conform to FCC regulations
- Excellent attenuation for high voltage impulse
- Metal case provides effective EMI shielding
- Two stages for excellent filtering characteristics
- Epoxy molded for reliability
- Structure provides effective shielding for noise generated both externally and internally
- Operating temperature: -25°C to +85°C (including temperature rise, see graph on page PF73)

Applications

- Digital equipment
- Personal computers and peripherals
- Measuring instruments and medical equipment
- Telecommunications equipment
- Equipment requiring very high noise attenuation

Circuit Diagram

62-MMF-XXX-7-11



Specifications

Model	Rated Voltage (@ 50/60Hz)	Rated Current	Leakage Current (Max.)	Capacitance			Inductance (L ₁) (2X)	Temperature Rise (Max.)
				C _{Y1}	C _{Y2}	C _X		
62-MMF-030-7-11	250VAC	3A	.7mA	3300pF	1000pF	0.1uF	3.7mH	30°C
62-MMF-050-7-11	250VAC	5A	.7mA	3300pF	1000pF	0.1uF	2.9mH	30°C

Note: All types are designed to meet the requirement of UL 1283, CSA 22.2, VDE 0565-3

Test voltage: 1500VAC one minute, line to ground

Insulation resistance: 300 Mohm min. at 500VDC

Leakage current: 0.7 mA max.

Voltage drop: 1V max.

Discharge time: 0.4 sec. max.

Weight: 6.0 ounces (170 grams)

Power Line Filters Dual Stage

62-MMF Series

Temperature Characteristics



Common Mode



62-MMF

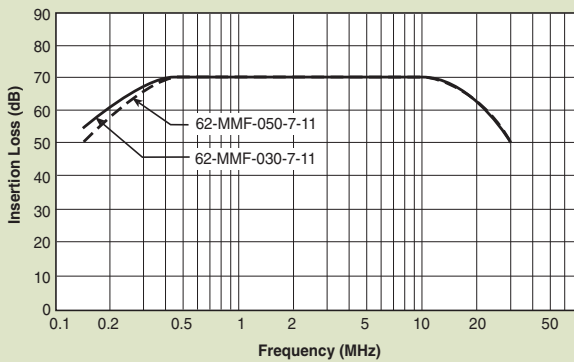

Normal Mode



62-MMF

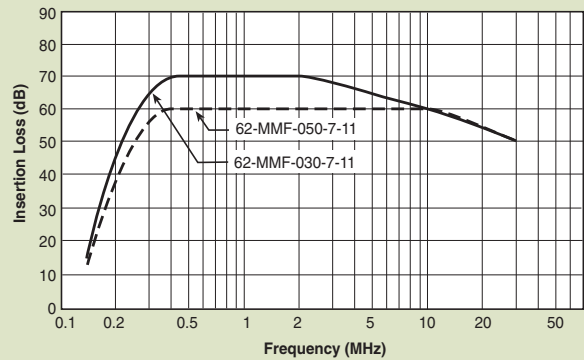

Power Line Filters Dual Stage



12-MMF & 12-MMB Series

Features

- Suitable for products that must conform to FCC regulations
- Excellent attenuation for high voltage impulse
- Metal case provides effective EMI shielding
- Two stages for excellent filtering characteristics
- Structure provides effective shielding for noise generated both externally and internally
- Operating temperature: -40°C to +85°C
- High performance
- Low leakage current

Applications

- Digital equipment
- Switching power supplies
- Personal computers and peripherals
- Measuring instruments and medical equipment
- Telecommunications equipment
- Equipment requiring very high noise attenuation

Circuit Diagram

Circuit 1

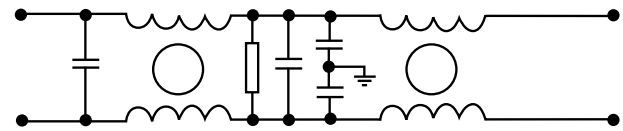

Circuit 2

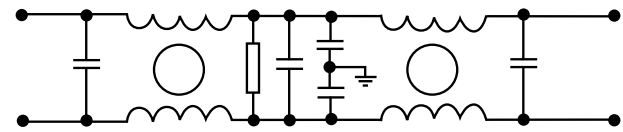

Circuit 3

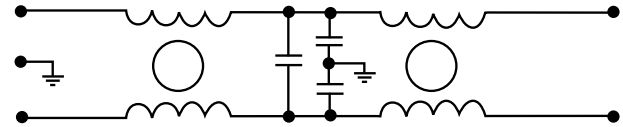

Specifications

Model	Rated Voltage (@ 50/60Hz)	Rated Current	Leakage Current (Max.)	Circuit Diagram	Figure	Temperature Rise (Max.)
12-MMF-002-5-F	120/250VAC	2A	0.25mA@120VAC/ 0.5mA@250VAC	1	A	30°C
12-MMF-003-5-F		3A			A	
12-MMF-003-5-A					B	
12-MMF-006-5-F		6A		A		
12-MMF-006-5-G				C		
12-MMF-008-5-B		8A				
12-MMF-010-5-F		10A		A		
12-MMF-010-5-G				A1		
12-MMF-010-5-B				C		
12-MMF-012-5-B		12A				
12-MMB-015-5-E		15A				
12-MMB-020-5-F		20A				
12-MMB-030-5-D		30A				
12-MMB-050-5-C		50A				

Note: All types are designed to meet the requirement of UL 1283, CSA 22.2, VDE 0565-3
 Test voltage: 1500VAC one minute, line to ground
 Insulation resistance: 300 Mohm min. at 500VDC
 Voltage drop: 1V max.
 Discharge time: 0.4 sec. max.

Power Line Filters Dual Stage

12-MMF & 12-MMB Series

Figure B



Figure C



Figure E



Figure F



Figure A



Figure A1



Figure D



Figure G



Dimensions in inches (mm)

Common Mode



12-MMF-002;-003;-006;-008



12-MMF-010;-012;-015;-020;-030;-050



Normal Mode

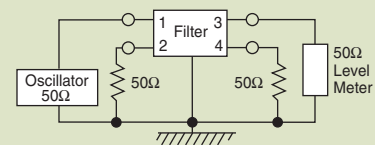

12-MMF-002;-003;-006;-008



12-MMF-010;-012;-015;-020;-030;-050

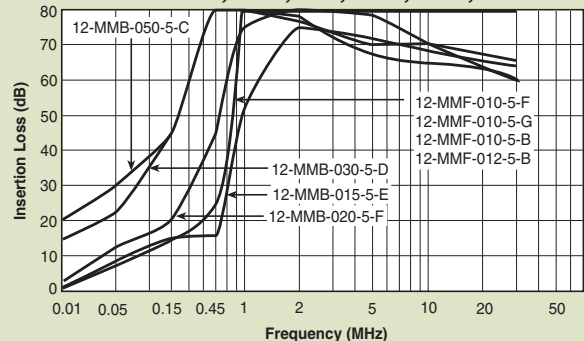

Power Line Filters Dual Stage



12-MMF & 12-MMB Series

Features

- Suitable for products that must conform to FCC regulations
- Excellent attenuation for high voltage impulse
- Metal case provides effective EMI shielding
- Two stages for excellent filtering characteristics
- Structure provides effective shielding for noise generated both externally and internally
- Operating temperature: -40°C to +85°C
- High performance

Applications

- Digital equipment
- Personal computers and peripherals
- Measuring instruments and medical equipment
- Telecommunications equipment
- Equipment requiring very high noise attenuation

Circuit Diagram

Circuit 1

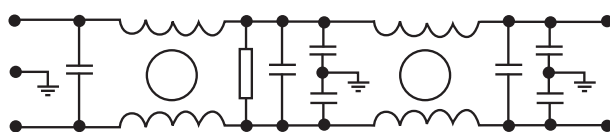

Circuit 2

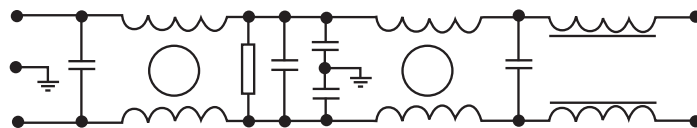

Specifications

Model	Rated Voltage (@ 50/60Hz)	Rated Current	Leakage Current (Max.)	Circuit Diagram	Figure	Temperature Rise (Max.)
12-MMF-003-11-F	120/250VAC	3A	1.5mA	1	A	30°C
12-MMF-006-11-F		6A			C	
12-MMF-010-11-F		10A			B	
12-MMB-015-11-G		15A		2	D	
12-MMB-020-11-D		20A			E	
12-MMB-030-11-D		30A			F	
12-MMB-040-11-B		40A		1		
12-MMB-040-11-E						
12-MMB-050-11-H		50A				

Note: All types are designed to meet the requirement of UL 1283, CSA 22.2. VDE 0565-3
 Test voltage: 1500VAC one minute, line to ground
 Insulation resistance: 300 Mohm min. at 500VDC
 Leakage current: 0.7 mA max.
 Voltage drop: 1V max.
 Discharge time: 0.4 sec. max.
 Weight: 6.0 ounces (170 grams)

Power Line Filters Dual Stage

12-MMF & 12-MMB Series

Figure A



Figure B

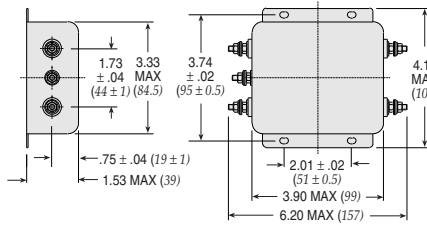

Figure C



Figure D



Figure E



Figure F

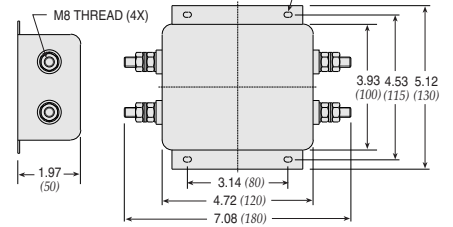

Dimensions in inches (mm)

Common Mode



12-MMF/MMB-003;-006;-010;-012;-015

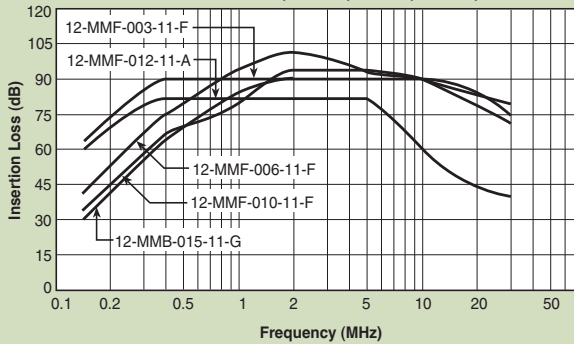

12-MMB-020;-030;-040;-050

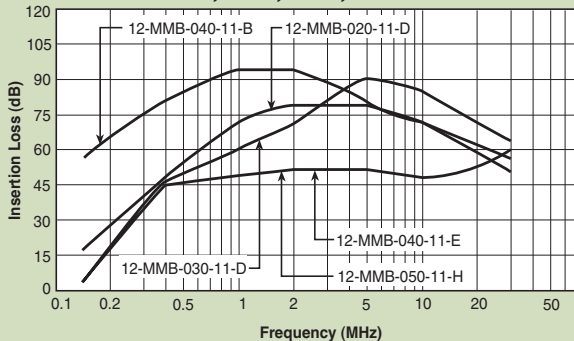

Normal Mode

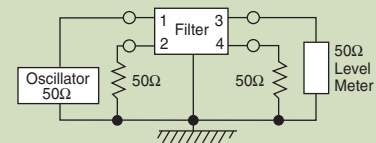

12-MMF/MMB-003;-006;-010;-012;-015

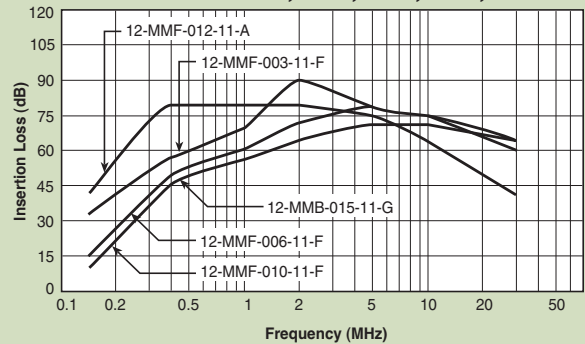

12-MMB-020;-030;-040;-050



Power Line Filters Dual Stage



12-MMF & 12-MMB Series

Features

- Suitable for products that must conform to FCC regulations
- Excellent attenuation for high voltage impulse
- Metal case provides effective EMI shielding
- Two stages for excellent filtering characteristics
- Epoxy molded for reliability
- Structure provides effective shielding for noise generated both externally and internally
- Operating temperature: -25°C to +85°C

Applications

- Digital equipment
- Personal computers and peripherals
- Measuring instruments and medical equipment
- Telecommunications equipment
- Equipment requiring very high noise attenuation

Circuit Diagram

Circuit 1



Circuit 2



Circuit 3



Specifications

Model	Rated Voltage (@ 50/60Hz)	Rated Current	Leakage Current (Max.)	Circuit Diagram	Figure	Temperature Rise (Max.)
12-MMF-001-5-F	120/250VAC	1A	0.5mA	3	A	30°C
12-MMF-003-5-G		3A			5uA	
12-MMF-003-2-G			6A	0.5mA		
12-MMF-006-5-G		10A	D			
12-MMB-010-5-D		15A				
12-MMB-015-5-E		20A				
12-MMB-020-5-E		30A				
12-MMB-030-5-E						

Note: All types are designed to meet the requirement of UL 1283, CSA 22.2. VDE 0565-3
 Test voltage: 1500VAC one minute, line to ground
 Insulation resistance: 300 Mohm min. at 500VDC
 Leakage current: 0.7 mA max.
 Voltage drop: 1V max.
 Discharge time: 0.4 sec. max.
 Weight: 6.0 ounces (170 grams)

Power Line Filters Dual Stage

12-MMF & 12-MMB Series

Figure A



Figure B



Figure C

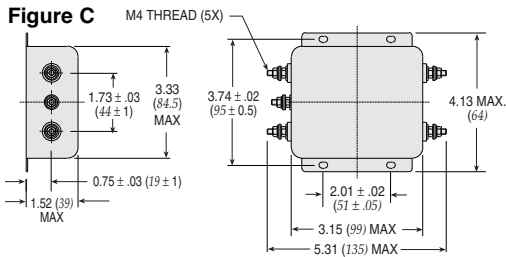
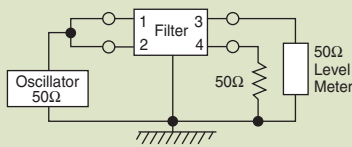

Figure D



Dimensions in inches (mm)

Common Mode



12-MMF-001;-003;-006



12-MMB-010;-015;-020;-030



Normal Mode

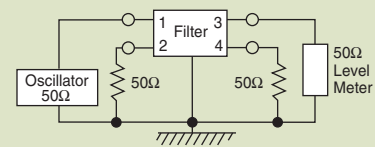

12-MMF-001;-003;-006



12-MMB-010;-015;-020;-030

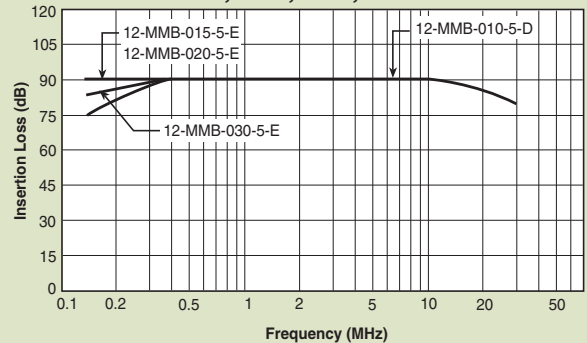

Компания «Океан Электроники» предлагает заключение долгосрочных отношений при поставках импортных электронных компонентов на взаимовыгодных условиях!

Наши преимущества:

- Поставка оригинальных импортных электронных компонентов напрямую с производств Америки, Европы и Азии, а так же с крупнейших складов мира;
- Широкая линейка поставок активных и пассивных импортных электронных компонентов (более 30 млн. наименований);
- Поставка сложных, дефицитных, либо снятых с производства позиций;
- Оперативные сроки поставки под заказ (от 5 рабочих дней);
- Экспресс доставка в любую точку России;
- Помощь Конструкторского Отдела и консультации квалифицированных инженеров;
- Техническая поддержка проекта, помощь в подборе аналогов, поставка прототипов;
- Поставка электронных компонентов под контролем ВП;
- Система менеджмента качества сертифицирована по Международному стандарту ISO 9001;
- При необходимости вся продукция военного и аэрокосмического назначения проходит испытания и сертификацию в лаборатории (по согласованию с заказчиком);
- Поставка специализированных компонентов военного и аэрокосмического уровня качества (Xilinx, Altera, Analog Devices, Intersil, Interpoint, Microsemi, Actel, Aeroflex, Peregrine, VPT, Syfer, Eurofarad, Texas Instruments, MS Kennedy, Miteq, Cobham, E2V, MA-COM, Hittite, Mini-Circuits, General Dynamics и др.);

Компания «Океан Электроники» является официальным дистрибьютором и эксклюзивным представителем в России одного из крупнейших производителей разъемов военного и аэрокосмического назначения «JONHON», а так же официальным дистрибьютором и эксклюзивным представителем в России производителя высокотехнологичных и надежных решений для передачи СВЧ сигналов «FORSTAR».



JONHON

«JONHON» (основан в 1970 г.)

Разъемы специального, военного и аэрокосмического назначения:

(Применяются в военной, авиационной, аэрокосмической, морской, железнодорожной, горно- и нефтедобывающей отраслях промышленности)

«FORSTAR» (основан в 1998 г.)

ВЧ соединители, коаксиальные кабели, кабельные сборки и микроволновые компоненты:

(Применяются в телекоммуникациях гражданского и специального назначения, в средствах связи, РЛС, а так же военной, авиационной и аэрокосмической отраслях промышленности).



Телефон: 8 (812) 309-75-97 (многоканальный)

Факс: 8 (812) 320-03-32

Электронная почта: ocean@oceanchips.ru

Web: <http://oceanchips.ru/>

Адрес: 198099, г. Санкт-Петербург, ул. Калинина, д. 2, корп. 4, лит. А