

Power Line Filters

Compact design requires minimal real estate and delivers excellent filtering characteristics for both differential and common mode. RoHS compliant, easily installed for a broad array of applications.



| | |
|--|-----------|
| Appliance Filters | PF50-PF53 |
| Single Stage..... | PF54-PF69 |
| With Wire Leads | PF56-PF57 |
| With Wire Leads for Medical Applications | PF58-PF59 |
| Higher Current | PF66-PF69 |
| DC – Higher Current | PF70-PF71 |
| Dual Stage..... | PF72-PF79 |

Power Line Filters Appliance Filters



11-MPC Series

Features

- Miniature general purpose PCB mounted filter
- Requires minimal PCB real estate space
- Low cost
- Operating temperature: -25°C to +70°C
- Two forms of cases are available: metal case and plastic case

Applications

- Personal computers and peripherals
- Digital equipment
- Measuring instruments and medical equipment
- TV & VCR monitors and display units
- Home appliances

Circuit Diagram

Circuit 1

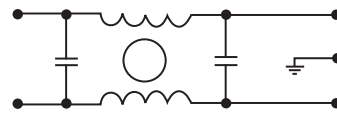

Circuit 2

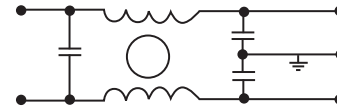

Circuit 3

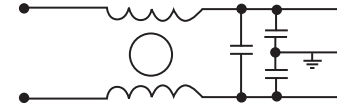

Circuit 4

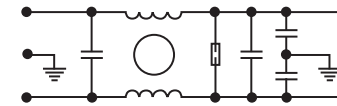

Specifications

| Model | Rated Voltage (@ 50/60Hz) | Rated Current | Leakage Current (Max.) | Circuit Diagram | Figure | Temperature Rise (Max.) |
|----------------|---------------------------|---------------|------------------------|-----------------|--------|-------------------------|
| 11-MPC-001-2-B | 120/250VAC | 1A | 0.50mA | 1 | A1 | 30°C |
| 11-MPC-001-5-A | | | | A | | |
| 11-MPC-001-5-B | | 2A | | A1 | | |
| 11-MPC-002-5-B | | | | D | | |
| 11-MPC-002-5-D | | 3A | | E | | |
| 11-MPC-003-5-E | | 6A | | A1 | | |
| 11-MPC-006-5-B | | | | C | | |
| 11-MPC-006-5-C | | 16A | | 0.2mA | 4 | |
| 11-MPC-016-5-B | | | | | | |

Note: Test voltage: 1500VAC one minute, line to ground
 Insulation resistance: 300 Mohm min. at 500VDC
 Voltage drop: 1V max. at rated current
 Weight: 17.5g

PCB Power Filters Miniature Printed Circuit Board

11-MPC Series

Figure A



Figure A1

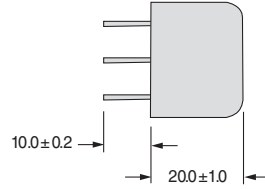

Figure B



Figure C



Figure D



Figure E

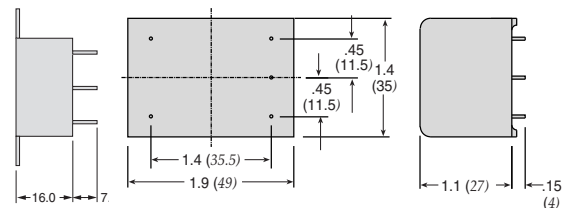

Dimensions in inches (mm)

Common Mode



11-MPC-001;-002



11-MPC-003;-006;-016



Normal Mode



11-MPC-001;-002



11-MPC-003;-006;-016



Power Line Filters Appliance Filters

62-AL/62-AC Series

Features

- Low-cost plastic case
- Compact design requires minimal real estate space
- Suitable for products that must conform to FCC regulations
- Wide variety of circuit and filtering options
- Good filtering characteristics for both normal mode and common mode
- Epoxy molded for reliability
- Operating temperature: -25°C to +85°C (including temperature rise, see graph on page PF53)

Applications

- Personal computers and peripherals
- Digital equipment
- Industrial equipment
- Vending machines
- Home appliances
- Office equipment

Specifications

| Model* | Rated Voltage (@ 50/60Hz) | Rated Current | Leakage Current (Max.) | Capacitance | | Inductance (L ₁) | Temperature Rise (Max.) | |
|-----------------|---------------------------|---------------|------------------------|----------------|----------------|------------------------------|-------------------------|--------|
| | | | | C _Y | C _X | | | |
| 62-AFL-010-3-11 | 250VAC | 1.0A | 0.35mA | 2200pF | 0.1uF | 11.0mH | 40°C | |
| 62-AFC-010-3-11 | | | 0.50mA | 3300pF | | | | |
| 62-AFL-010-5-11 | | | 0.35mA | 2200pF | | | | |
| 62-AFC-010-5-11 | | | | 3300pF | | | | |
| 62-AFL-016-3-11 | | 1.6A | 0.35mA | 2200pF | | | | |
| 62-AFC-016-3-11 | | | | 3300pF | | | | |
| 62-AFL-016-5-11 | | 0.35mA | 0.50mA | 2200pF | | | | |
| 62-AFC-016-5-11 | | | | 3300pF | | | | |
| 62-AFL-030-3-11 | | 3.0A | 0.35mA | 2200pF | | | | |
| 62-AFC-030-3-11 | | | | 3300pF | | | | |
| 62-AFL-030-5-11 | | 0.35mA | 0.50mA | 2200pF | | | | |
| 62-AFC-030-5-11 | | | | 3300pF | | | | |
| 62-AFL-045-3-11 | | 4.5A | 0.35mA | 2200pF | | | | |
| 62-AFC-045-3-11 | | | | 3300pF | | | | |
| 62-AFL-045-5-11 | | | | 0.35mA | | 0.50mA | | 2200pF |
| 62-AFC-045-5-11 | | | | | | | | 3300pF |
| 62-AFL-060-3-11 | | 6.0A | 0.35mA | 2200pF | | | | |
| 62-AFC-060-3-11 | | | | 3300pF | | | | |
| 62-AFL-060-5-11 | | | | 0.35mA | | 0.50mA | | 2200pF |
| 62-AFC-060-5-11 | | | | | | | | 3300pF |

Note: All types are designed to meet the requirement of UL 1283, CSA 22.2. VDE 0565-3
 Test voltage: 1500VAC one minute, line to ground
 Insulation resistance: 300 Mohm min. at 500VDC
 Voltage drop: 1V max.

* Available with bleeder resistor
 Replace F with R for part number



Circuit Diagrams



Power Line Filters Appliance Filters

62-AL/62-AC Series

Common Mode



62-AFL-xxx-3-11



62-AFC-XXX-3-11



62-AFL-xxx-5-11



62-AFC-xxx-5-11



Temperature Characteristics



Normal Mode



62-AFL-XXX-3-11



62-AFC-XXX-3-11



62-AFL-xxx-5-11



62-AFC-xxx-5-11



Power Line Filters Single Stage

62-PPF/PQF/PRF Series



Tested and found to be
IAW VDE 0565 Part 3

Features

- Low-cost plastic case
- Compact design requires minimal real estate space
- Suitable for products that must conform to FCC and FTZ regulations
- Wide variety of circuit and filtering options
- Good filtering characteristics for both normal mode and common mode
- Epoxy molded for reliability
- Operating temperature: -25°C to +85°C (including temperature rise, see graph on page PF55)

Applications

- Personal computers and peripherals
- Digital equipment
- Industrial equipment
- Vending machines
- Office equipment



Circuit Diagrams



* Bleeder Resistor is available only for
62-P(Q/R/P)F-XXX-X-12

Specifications

| Model | Rated Voltage (@ 50/60Hz) | Rated Current | Leakage Current (Max.) | Capacitance | | Inductance (L ₁) | Temperature Rise (Max.) | |
|-----------------|------------------------------|---------------|---------------------------|----------------|----------------|---------------------------------|----------------------------|-----|
| | | | | C _Y | C _X | | | |
| 62-PQF-020-5-11 | 250VAC | 2A | 0.50mA | 3300pF | 0.1uF | 15mH | 30°C | |
| 62-PQF-020-5-12 | | | | | .22uF | | | |
| 62-PPF-020-5-11 | | | | | 0.1uF | | | |
| 62-PPF-020-5-12 | | | | | .22uF | | | |
| 62-PQF-030-5-11 | | | | | 0.1uF | | | 8mH |
| 62-PQF-030-5-12 | | | | | .22uF | | | |
| 62-PPF-030-5-11 | | 0.1uF | | | | | | |
| 62-PPF-030-5-12 | | .22uF | | | | | | |
| 62-PQF-060-5-11 | | 0.1uF | | | 2.1mH | | | |
| 62-PQF-060-5-12 | | .22uF | | | | | | |
| 62-PPF-060-5-11 | | 0.1uF | | | | | | |
| 62-PPF-060-5-12 | | .22uF | | | | | | |
| 62-PRF-010-5-11 | | 0.1uF | | | 486uH | | | |
| 62-PRF-010-5-12 | | .22uF | | | | | | |
| 62-PRF-020-5-11 | | 0.1uF | | | 181uH | | | |
| 62-PRF-020-5-12 | | .22uF | | | | | | |
| 62-PRF-030-5-11 | | 0.1uF | | | 97uH | | | |
| 62-PRF-030-5-12 | | .22uF | | | | | | |

Note: All types are designed to meet the requirement of UL 1283, CSA 22.2, VDE 0565-3

Test voltage: 1500VAC one minute, line to ground

Insulation resistance: 300 Mohm min. at 500VDC

Voltage drop: 1V max. (except 62-PRF-010-5-11) at rated current

62-PRF-010-5-11: 1.5V max. at rated current

Weight: 62-PPF & PQF Series: 2.11 ounces (60 grams)

62-PRF Series: 1.76 ounces (50 grams)

Power Line Filters Single Stage

62-PPF/PQF/PRF Series

Temperature Characteristics

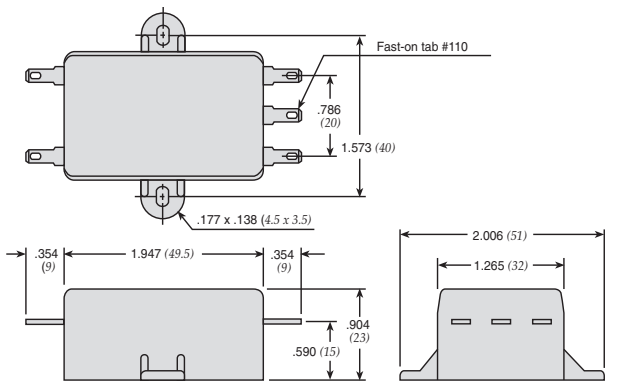

Also available with .250 Fast-ons

Dimensions in inches (mm)

Normal Mode



62-PQF Series



62-PPF Series



Common Mode



62-P(Q/R)F Series



62-PRF Series



Power Line Filters Single Stage Wire Leads



62-PML Series



Tested and found to be
IAW VDE 0565 Part 3

Features

- Compact design requires minimal real estate space
- Suitable for products that must conform to FCC and FTZ regulations
- Excellent attenuation for high voltage impulse
- Metal case provides effective shielding
- Excellent filtering characteristics for both normal mode and common mode
- Structure provides effective shielding for noise generated externally and internally
- Operating temperature: -25°C to +85°C (including temperature rise, see graph on page PF57)

Applications

- Digital equipment
- Personal computers and peripherals
- Measuring instruments
- Medical equipment
- Factory automation equipment

Circuit Diagram



Specifications

| Model | Rated Voltage (@ 50/60Hz) | Rated Current | Leakage Current (Max.) | Capacitance | | Inductance (L ₁) | Temperature Rise (Max.) |
|-----------------|---------------------------|---------------|------------------------|----------------|----------------|------------------------------|-------------------------|
| | | | | C _Y | C _X | | |
| 62-PML-015-3-11 | 250VAC | 1.5A | 0.35mA | 0.1µF | 3300pF | 10.0mH | 30°C |
| 62-PML-015-5-11 | | | 0.50mA | | | 4.3mH | |
| 62-PML-030-3-11 | | 3A | 0.35mA | | | 2.4mH | |
| 62-PML-030-5-11 | | | 0.50mA | | | | |
| 62-PML-050-3-11 | | 5A | 0.35mA | | | | |
| 62-PML-050-5-11 | | | 0.50mA | | | | |

Note: All types are designed to meet the requirement of UL 1283, CSA 22.2. VDE 0565-3
 Test voltage: 1500VAC one minute, line to ground
 Insulation resistance: 300 Mohm min. at 500VDC
 Voltage drop: 1V max. at rated current
 Weight: 62-PML-015 Series: 3.06 ounces (87 grams)
 62-PML-030 Series: 3.17 ounces (90 grams)
 62-PML-050 Series: 3.28 ounces (93 grams)
 Discharge time: 0.4 sec. max.

Power Line Filters Single Stage Wire Leads

62-PML Series

Temperature Characteristics



* Custom lengths available upon request. Dimensions in inches (mm)

Common Mode



Normal Mode

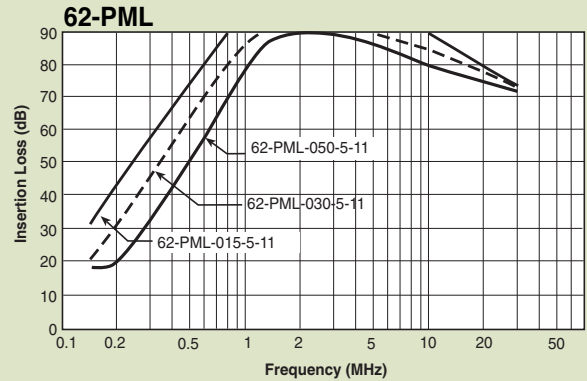

Power Line Filters Single Stage Wire Leads

for Medical Purpose Applications

12-PML & 12-PMF Series



Features

- Compact design requires minimal real estate space
- Suitable for products that must conform to FCC and FTZ regulations
- Excellent attenuation for high voltage impulse
- Metal case provides effective shielding
- Excellent filtering characteristics for both normal mode and common mode
- Structure provides effective shielding for noise generated externally and internally
- Operating temperature: -25°C to +70°C
- Low leakage current

Applications

- Digital equipment
- Personal computers and peripherals
- Measuring instruments
- Medical equipment
- Factory automation equipment



Circuit Diagram

Circuit 1



Circuit 2

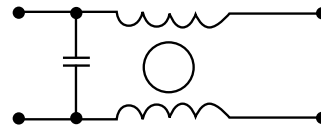

Specifications

| Model | Rated Voltage (@ 50/60Hz) | Rated Current | Leakage Current (Max.) | Circuit Diagram | Figure | Temperature Rise (Max.) |
|----------------|---------------------------|---------------|------------------------|-----------------|--------|-------------------------|
| 12-PML-001-2-A | 120/250VAC | 1A | 5uA | 1 | A | 30°C |
| 12-PML-002-2-A | | 2A | | | | |
| 12-PML-006-2-A | | 6A | | | | |
| 12-PML-010-2-A | | 10A | | 2 | B | |
| 12-PMF-001-2-B | | 1A | | | | |
| 12-PMF-002-2-B | | 2A | | | | |
| 12-PMF-006-2-B | | 6A | | 1 | C | |
| 12-PML-001-2-C | | 1A | | | | |

Note: All types are designed to meet the requirement of UL 1283, CSA 22.2. VDE 0565-3
 Test voltage: 1500VAC one minute, line to ground
 Insulation resistance: 300 Mohm min. at 500VDC
 Voltage drop: 1V max. at rated current
 Discharge time: 0.4 sec. max.

Power Line Filters Single Stage Wire Leads

for Medical Purpose Applications

12-PML & 12-PMF Series

Figure A



Figure C



Figure B



Dimensions in inches (mm)

Common Mode



12-PML-001;-002;-006;-010



12-PMF-001;-002;-006;-010



Normal Mode



12-PML-001;-002;-006;-010



12-PMF-001;-002;-006;-010



Power Line Filters Single Stage



62-LMF & LMB Series



Tested and found to be
IAW VDE 0565 Part 3

Features

- Space saving, compact designs
- Suitable for products that must conform to FCC and FTZ regulations
- Excellent filtering characteristics for both normal mode and common mode
- Structure provides effective shielding for noise generated externally and internally
- Metal case provides effective shielding
- Rugged construction
- Operating temperature: -25°C to +85°C (including temperature rise, see graph on page PF61)

Applications

- Digital equipment
- Office automation equipment, such as copy and fax machines
- Computers and peripherals
- Instrumentation and controls

Circuit Diagram



Specifications

| Model* | Rated Voltage (@ 50/60Hz) | Rated Current | Leakage Current (Max.) | Capacitance | | Inductance (L ₁) | Temperature Rise (Max.) |
|-----------------|---------------------------|---------------|------------------------|----------------|----------------|------------------------------|-------------------------|
| | | | | C _Y | C _X | | |
| 62-LMB-030-5-11 | 250VAC | 3A | 0.50mA | 3300pF | 0.1uF | 14mH | 45°C |
| 62-LMF-030-5-11 | | 5A | | | 0.1uF & .22uF | 7.0mH | |
| 62-LMB-050-5-11 | | | | | 8A | .22uF | |
| 62-LMF-050-5-11 | | 10A | | | | .33uF | |
| 62-LMB-080-5-11 | | | | | .33uF | 2.2mH | |
| 62-LMF-080-5-11 | | | | | | | |
| 62-LMB-100-5-11 | | | | | | | |
| 62-LMF-100-5-11 | | | | | | | |

Note: Test voltage: 1500VAC one minute, line to ground
 Insulation resistance: 300 Mohm min. at 500VDC
 Voltage drop: 1V max. at rated current
 Discharge time: 0.4 sec. max.
 Weight: 5.3 ounces (150 grams)

*62-LMF - designates Fast-on terminals
 62-LMB - designates Bolt-in terminals
 62-LML - wire lead in/outputs also available

Power Line Filters Single Stage

62-LMF & LMB Series

Temperature Characteristics



62-LMB



62-LMF



Dimensions in inches (mm)

Common Mode



62-LMF & LMB

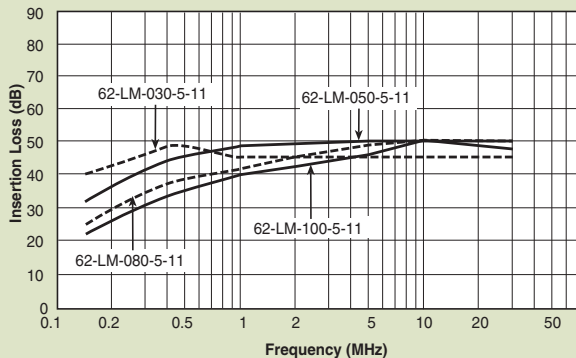

Normal Mode

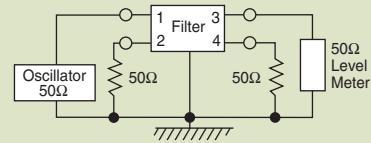

62-LMF & LMB



Power Line Filters Single Stage



62-PMF & PMB Series



Tested and found to be
IAW VDE 0565 Part 3

Features

- Space-saving, compact designs
- Suitable for products that must conform to FCC regulations
- Excellent attenuation for high voltage impulse
- Metal case provides effective EMI shielding
- Excellent filtering characteristics for both normal mode and common mode
- Epoxy molded for internal component reliability
- Structure provides effective shielding for noise generated externally and internally
- Operating temperature: -25°C to +85°C (including temperature rise, see graph on page PF63)

Applications

- Digital equipment
- Computers and peripherals
- Measuring instruments
- Medical equipment
- Equipment requiring very high impulse attenuation
- Factory automation equipment
- Industrial equipment such as UPS, inverters and converters
- Telecommunications equipment
- Office automation equipment, such as copy and fax machines

Circuit Diagram



Specifications

| Model* | Rated Voltage (@ 50/60Hz) | Rated Current | Leakage Current (Max.) | Capacitance | | Inductance (L ₁) | Temperature Rise (Max.) | | | | |
|-----------------|---------------------------|---------------|------------------------|----------------|----------------|------------------------------|-------------------------|------|-------|--------|--------|
| | | | | C _Y | C _X | | | | | | |
| 62-PMB-050-5-11 | 250VAC | 5A | 0.50mA | 3300pF | 0.1uF | 14mH | 30°C | | | | |
| 62-PMF-050-5-11 | | 8A | | | | | | .1uF | 7.0mH | | |
| 62-PMB-080-5-11 | | | | | | | | | | 10A | .22uF |
| 62-PMF-080-5-11 | | 15A | | | .33uF | 2.2mH | | 35°C | | | |
| 62-PMB-100-5-12 | | | | | | | | | 20A | 1.8mH | 45°C** |
| 62-PMF-100-5-12 | | | | | | | | | | | |
| 62-PMB-150-5-13 | | 20A | | | 1.8mH | 45°C** | | | | | |
| 62-PMF-150-5-13 | | | | | | | | 20A | 1.8mH | 45°C** | |
| 62-PMB-200-5-13 | | 20A | | | 1.8mH | 45°C** | | | | | |
| 62-PMF-200-5-13 | 20A | | 1.8mH | 45°C** | | | | | | | |

Note: Test voltage: 1500VAC one minute, line to ground
Insulation resistance: 300 Mohm min. at 500VDC
Voltage drop: 1V max.
Discharge time: 0.4 sec. max.
Weight: 8.82 ounces (250 grams)

* PMF - designates Fast-on terminals

PMB - designates Bolt-in terminals

** The temperature rise of 20 amp units can be decreased to 30°C by mounting on 200 X 200 x 1.0(mm) steel chassis

Power Line Filters Single Stage

62-PMF & PMB Series

Temperature Characteristics



62-PMF



62-PMB



| MODEL | A | B | C |
|--------------------|---------------|--------------|--------------|
| 62-PMF/PMB-100-200 | 1.490 (38) | .944 (24) | .433 (11) |
| 62-PMF/PMB-050-080 | 1.258 (32) | .786 (20) | 0 (0) |

Dimensions in inches (mm)

Common Mode



Normal Mode

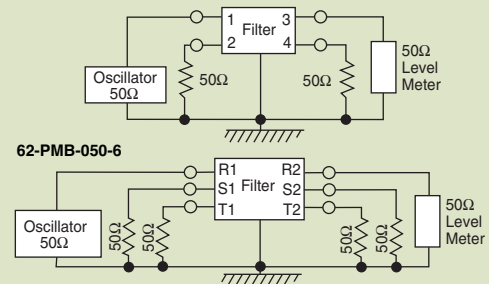

Power Line Filters Single Stage

12-PMF Series



Features

- Space-saving, compact designs
- Suitable for products that must conform to FCC regulations
- Excellent attenuation for high voltage impulse
- Metal case provides effective EMI shielding
- Excellent filtering characteristics for both normal mode and common mode
- Epoxy molded for internal component reliability
- Structure provides effective shielding for noise generated externally and internally
- Operating temperature: -25°C to +85°C

Applications

- Digital equipment
- Computers and peripherals
- Measuring instruments
- Medical equipment
- Equipment requiring very high impulse attenuation
- Factory automation equipment
- Industrial equipment such as UPS, inverters and converters
- Telecommunications equipment
- Office automation equipment, such as copy and fax machines



Circuit Diagram

Circuit 1



Circuit 2



Circuit 3



Circuit 4



Circuit 5



Circuit 6



Specifications

| Model | Rated Voltage (@ 50/60Hz) | Rated Current | Leakage Current (Max.) | Circuit Diagram | Figure | Temperature Rise (Max.) |
|----------------|---------------------------|---------------|------------------------|-----------------|--------|-------------------------|
| 12-PMF-001-5-A | 120/250VAC | 1A | 0.5mA | 1 | A | 30°C |
| 12-PMF-002-5-B | | 2A | | 2 | B | |
| 12-PMF-003-5-A | | 3A | | 4 | A | |
| 12-PMF-003-5-B | | 2A | | 2 | B | |
| 12-PMF-006-5-A | | 6A | | 4 | A | |
| 12-PMF-006-5-C | | 1A | | 1 | C | |
| 12-PMF-006-5-D | | 6A | | 6 | D | |
| 12-PMF-010-5-A | | 10A | | 2 | A | |
| 12-PMF-010-5-C | | 3A | | 3 | C | |
| 12-PMF-015-5-C | | 15A | | 5 | E | |
| 12-PMF-015-5-E | | C | | | | |
| 12-PMF-020-5-C | | 20A | | | D | |
| 12-PMF-020-5-D | | D | | | | |
| 12-PMF-020-5-E | | E | | | | |

Note: Test voltage: 1500VAC one minute, line to ground
 Insulation resistance: 300 Mohm min. at 500VDC
 Voltage drop: 1V max.
 Discharge time: 0.4 sec. max.

Power Line Filters Single Stage

12-PMF Series

Figure A



Figure B



Figure C



Figure D



Figure E



Dimensions in inches (mm)

Common Mode



12-PMF-001;-002;-003;-006



12-PMF-001;-002;-003;-006



Normal Mode



12-PMF-001;-002;-003;-006



12-PMF-010;-015;-020



Power Line Filters Single Stage - Higher Current



62-PMB Series

Features

- Space-saving, compact designs
- Suitable for products that must conform to FCC regulations
- Excellent attenuation for high voltage impulse
- Metal case provides effective shielding
- Excellent filtering characteristics for both normal mode and common mode
- Epoxy molded for internal component reliability
- Structure provides effective shielding for noise generated externally and internally
- Safety agency approvals pending
- Designed to be in accordance with VDE 0565 Part 3
- Operating temperature: -25°C to +85°C (including temperature rise)

Applications

- Digital equipment
- Computers and peripherals
- Measuring instruments
- Medical equipment
- Equipment requiring very high impulse attenuation
- Factory automation equipment
- Industrial equipment such as UPS, inverters and converters
- Telecommunications equipment
- Office automation equipment, such as copy and fax machines

Circuit Diagram



Specifications

| Model | Rated Voltage (@ 50/60Hz) | Rated Current | Leakage Current (Max.) | Capacitance | | Inductance (L ₁) | Temperature Rise (Max.) |
|-----------------|---------------------------|---------------|------------------------|----------------|----------------|------------------------------|-------------------------|
| | | | | C _Y | C _X | | |
| 62-PMB-300-5-14 | 250VAC | 30A | 0.50mA | 3300pF | .47uF | 1.6mH | 45°C |
| 62-PMB-400-5-14 | | 40A | | | | 0.8mH | |

Note: Test voltage: 1500VAC one minute, line to earth
 Insulation resistance: 300 Mohm min. at 500VDC
 Voltage drop: 1V max.
 Discharge time: 0.4 sec. max.
 Weight: 8.82 ounces (250 grams)

Power Line Filters Single Stage - Higher Current

62-PMB Series

62-PMB-300-5-14 and 62-PMB-400-5-14



Dimensions in inches (mm)

Normal Mode



Common Mode



Power Line Filters Single Stage - Higher Current



12-PMB Series

Features

- Space-saving, compact designs
- Suitable for products that must conform to FCC regulations
- Excellent attenuation for high voltage impulse
- Metal case provides effective shielding
- Excellent filtering characteristics for both normal mode and common mode
- Epoxy molded for internal component reliability
- Structure provides effective shielding for noise generated externally and internally
- Designed to be in accordance with VDE 0565 Part 3
- Operating temperature: -25°C to +85°C

Applications

- Digital equipment
- Computers and peripherals
- Measuring instruments
- Medical equipment
- Equipment requiring very high impulse attenuation
- Factory automation equipment
- Industrial equipment such as UPS, inverters and converters
- Telecommunications equipment
- Office automation equipment, such as copy and fax machines

Circuit Diagram



Specifications

| Model | Rated Voltage (@ 50/60Hz) | Rated Current | Leakage Current (Max.) | Circuit Diagram | Figure | Temperature Rise (Max.) |
|----------------|---------------------------|---------------|------------------------|-----------------|--------|-------------------------|
| 12-PMB-025-5-A | 120/250VAC | 25A | 0.5mA | 1 | A | 30°C |
| 12-PMB-030-5-A | | 30A | | | | |
| 12-PMB-035-5-B | | 35A | | | | |
| 12-PMB-050-5-B | | 50A | | | | |
| 12-PMB-100-8-C | | 100A | 1.0mA | | | |
| 12-PMB-120-8-C | | 120A | | | | |

Note: Test voltage: 1500VAC one minute, line to earth
 Insulation resistance: 300 Mohm min. at 500VDC
 Voltage drop: 1V max.
 Discharge time: 0.4 sec. max.
 Weight: 8.82 ounces (250 grams)

Power Line Filters Single Stage - Higher Current

12-PMB Series

Figure A



Figure B



Figure C



Dimensions in inches (mm)

Common Mode



12-PMB-025;-030;-035



12-PMB-050;-100;-120



Normal Mode



12-PMB-025;-030;-035



12-PMB-050;-100;-120



Power Line Filters DC - Higher Current



12-PMF & 12 PMB DC Series

Features

- Space-saving, compact designs
- Suitable for products that must conform to FCC regulations
- Excellent attenuation for high voltage impulse
- Metal case provides effective shielding
- Excellent filtering characteristics for both normal mode and common mode
- Epoxy molded for internal component reliability
- Structure provides effective shielding for noise generated externally and internally
- Designed to be in accordance with VDE 0565 Part 3
- Operating temperature: -40°C to +85°C

Applications

- Digital equipment
- Computers and peripherals
- Measuring instruments
- Equipment requiring very high impulse attenuation
- Factory automation equipment
- Industrial equipment such as UPS, inverters and converters
- Telecommunications equipment

Circuit Diagram

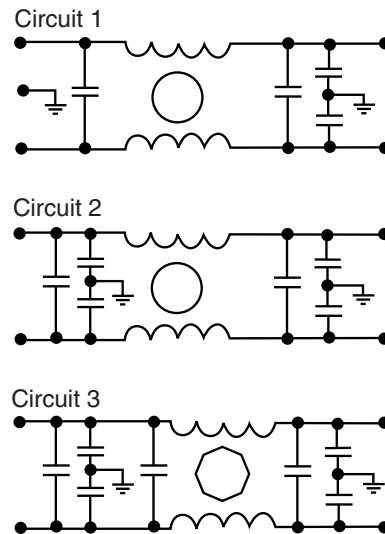

Specifications

| Model | Rated Voltage (@ 50/60Hz) | Rated Current | Circuit Diagram | Figure | Temperature Rise (Max.) |
|-----------------|---------------------------|---------------|-----------------|--------|-------------------------|
| 12-PMF-006-DC-C | 48/250 VDC | 6A | 1 | A | 30°C |
| 12-PMF-010-DC-C | | 10A | | | |
| 12-PMF-015-DC-C | | 15A | | | |
| 12-PMF-020-DC-C | | 20A | | | |
| 12-PMF-025-DC-D | | 25A | | | |
| 12-PMB-025-DC-F | | | | | |
| 12-PMB-030-DC-F | | 30A | | C | |
| 12-PMB-035-DC-F | | 35A | | | |
| 12-PMB-040-DC-F | | 40A | | | |
| 12-PMB-040-DC-B | | 50A | | D | |
| 12-PMB-050-DC-B | | 60A | | | |
| 12-PMB-060-DC-B | | 80A | E | | |
| 12-PMB-080-DC-G | | | | | |
| 12-PMB-080-DC-C | | 100A | 2 | F | |
| 12-PMB-100-DC-C | | | | | |
| 12-PMB-120-DC-C | | | | | |
| 12-PMB-140-DC-C | | 140A | 3 | | |
| 12-PMB-180-DC-E | | 180A | | | |
| 12-PMB-200-DC-E | | 200A | | | |
| 12-PMB-260-DC-E | | 260A | | | |
| | | | 2 | G | |

Note: Test voltage: 1500VAC one minute, line to earth
Insulation resistance: 300 Mohm min. at 500VDC
Voltage drop: 1V max.

Discharge time: 0.4 sec. max.
Weight: 8.82 ounces (250 grams)

Power Line Filters DC - Higher Current

12-PMF & 12-PMB DC Series

Figure B

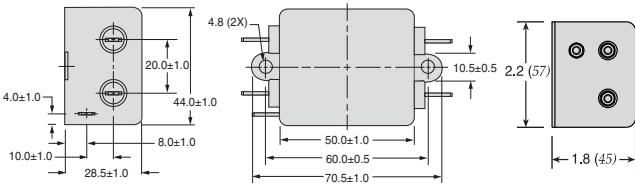

Figure C

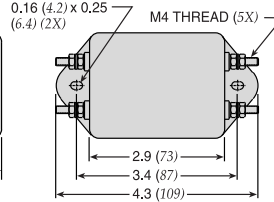

Figure A



Figure D



Figure E

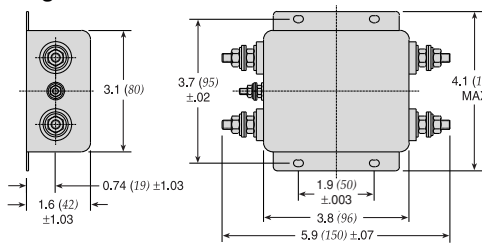

Figure F

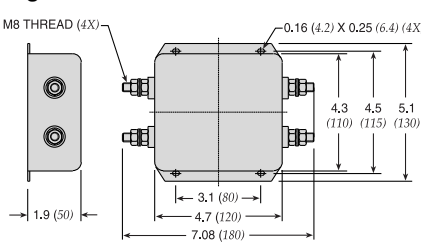
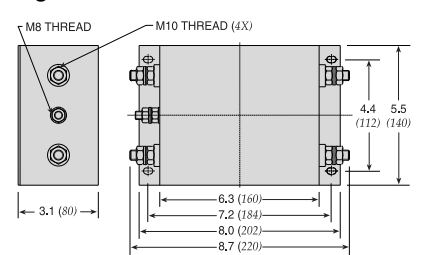

Figure G



Dimensions in inches (mm)

Common Mode



12-PMF-006;-010;-015;-020;-025



12-PMB-025; thru -260



Normal Mode



12-PMF-006;-010;-015;-020;-025

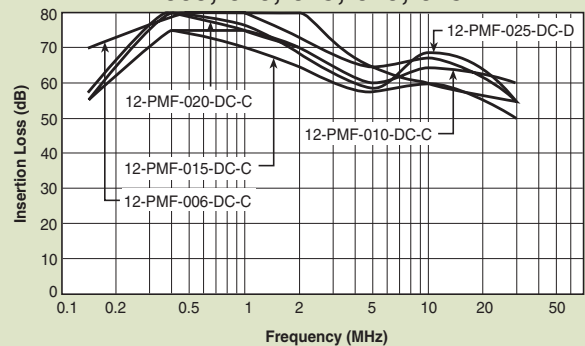

12-PMB-025; thru -260

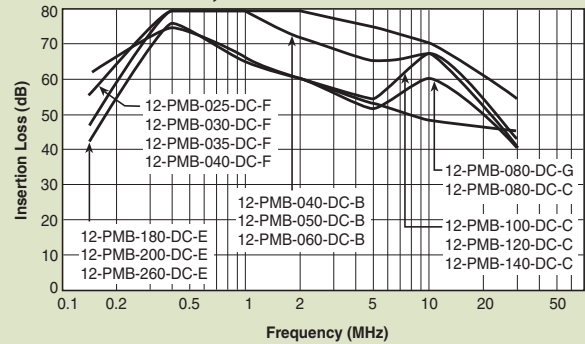

Power Line Filters Dual Stage



62-MMF Series

Features

- Suitable for products that must conform to FCC regulations
- Excellent attenuation for high voltage impulse
- Metal case provides effective EMI shielding
- Two stages for excellent filtering characteristics
- Epoxy molded for reliability
- Structure provides effective shielding for noise generated both externally and internally
- Operating temperature: -25°C to +85°C (including temperature rise, see graph on page PF73)

Applications

- Digital equipment
- Personal computers and peripherals
- Measuring instruments and medical equipment
- Telecommunications equipment
- Equipment requiring very high noise attenuation

Circuit Diagram

62-MMF-XXX-7-11



Specifications

| Model | Rated Voltage (@ 50/60Hz) | Rated Current | Leakage Current (Max.) | Capacitance | | | Inductance (L ₁) (2X) | Temperature Rise (Max.) |
|-----------------|------------------------------|---------------|---------------------------|-----------------|-----------------|----------------|--------------------------------------|----------------------------|
| | | | | C _{Y1} | C _{Y2} | C _X | | |
| 62-MMF-030-7-11 | 250VAC | 3A | .7mA | 3300pF | 1000pF | 0.1uF | 3.7mH | 30°C |
| 62-MMF-050-7-11 | 250VAC | 5A | .7mA | 3300pF | 1000pF | 0.1uF | 2.9mH | 30°C |

Note: All types are designed to meet the requirement of UL 1283, CSA 22.2, VDE 0565-3
 Test voltage: 1500VAC one minute, line to ground
 Insulation resistance: 300 Mohm min. at 500VDC
 Leakage current: 0.7 mA max.
 Voltage drop: 1V max.
 Discharge time: 0.4 sec. max.
 Weight: 6.0 ounces (170 grams)

Power Line Filters Dual Stage

62-MMF Series

Temperature Characteristics



Common Mode



62-MMF



Normal Mode



62-MMF



Power Line Filters Dual Stage



12-MMF & 12-MMB Series

Features

- Suitable for products that must conform to FCC regulations
- Excellent attenuation for high voltage impulse
- Metal case provides effective EMI shielding
- Two stages for excellent filtering characteristics
- Structure provides effective shielding for noise generated both externally and internally
- Operating temperature: -40°C to +85°C
- High performance
- Low leakage current

Applications

- Digital equipment
- Switching power supplies
- Personal computers and peripherals
- Measuring instruments and medical equipment
- Telecommunications equipment
- Equipment requiring very high noise attenuation

Circuit Diagram

Circuit 1



Circuit 2



Circuit 3



Specifications

| Model | Rated Voltage (@ 50/60Hz) | Rated Current | Leakage Current (Max.) | Circuit Diagram | Figure | Temperature Rise (Max.) | |
|----------------|---------------------------|---------------|--------------------------------|-----------------|--------|-------------------------|---|
| 12-MMF-002-5-F | 120/250VAC | 2A | 0.25mA@120VAC/ 0.5mA@250VAC | 1 | A | 30°C | |
| 12-MMF-003-5-F | | 3A | | | A | | |
| 12-MMF-003-5-A | | | | | B | | |
| 12-MMF-006-5-F | | 6A | | A | 2 | | |
| 12-MMF-006-5-G | | | | C | | | |
| 12-MMF-008-5-B | | 8A | | A | | | |
| 12-MMF-010-5-F | | 10A | | A1 | | | |
| 12-MMF-010-5-G | | | | | | | C |
| 12-MMF-010-5-B | | | | | | | D |
| 12-MMF-012-5-B | | 12A | | G | | | |
| 12-MMB-015-5-E | | 15A | | E | | | |
| 12-MMB-020-5-F | | 20A | | F | | | |
| 12-MMB-030-5-D | | 30A | | | | | |
| 12-MMB-050-5-C | | 50A | | | | | |

Note: All types are designed to meet the requirement of UL 1283, CSA 22.2, VDE 0565-3
 Test voltage: 1500VAC one minute, line to ground
 Insulation resistance: 300 Mohm min. at 500VDC
 Voltage drop: 1V max.
 Discharge time: 0.4 sec. max.

Power Line Filters Dual Stage

12-MMF & 12-MMB Series

Figure B

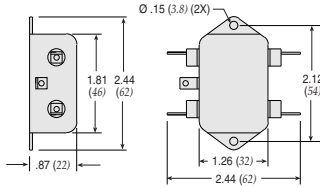

Figure C



Figure E



Figure F



Figure A



Figure A1



Figure D

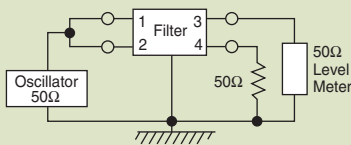

Figure G



Dimensions in inches (mm)

Common Mode



12-MMF-002;-003;-006;-008



12-MMF-010;-012;-015;-020;-030;-050

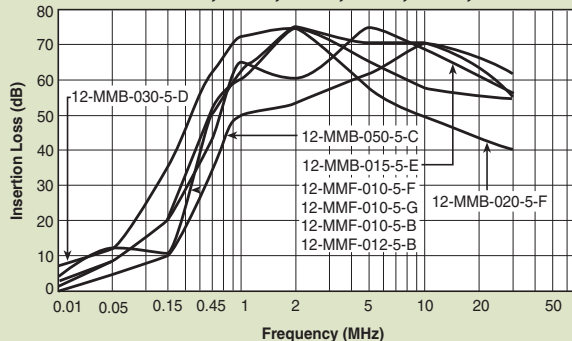

Normal Mode

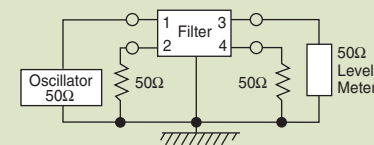

12-MMF-002;-003;-006;-008



12-MMF-010;-012;-015;-020;-030;-050



Power Line Filters Dual Stage



12-MMF & 12-MMB Series

Features

- Suitable for products that must conform to FCC regulations
- Excellent attenuation for high voltage impulse
- Metal case provides effective EMI shielding
- Two stages for excellent filtering characteristics
- Structure provides effective shielding for noise generated both externally and internally
- Operating temperature: -40°C to +85°C
- High performance

Applications

- Digital equipment
- Personal computers and peripherals
- Measuring instruments and medical equipment
- Telecommunications equipment
- Equipment requiring very high noise attenuation

Circuit Diagram

Circuit 1



Circuit 2



Specifications

| Model | Rated Voltage (@ 50/60Hz) | Rated Current | Leakage Current (Max.) | Circuit Diagram | Figure | Temperature Rise (Max.) |
|-----------------|---------------------------|---------------|------------------------|-----------------|--------|-------------------------|
| 12-MMF-003-11-F | 120/250VAC | 3A | 1.5mA | 1 | A | 30°C |
| 12-MMF-006-11-F | | 6A | | | C | |
| 12-MMF-010-11-F | | 10A | | | B | |
| 12-MMB-015-11-G | | 15A | | 2 | D | |
| 12-MMB-020-11-D | | 20A | | | E | |
| 12-MMB-030-11-D | | 30A | | | F | |
| 12-MMB-040-11-B | | 40A | | 1 | | |
| 12-MMB-040-11-E | | | | | | |
| 12-MMB-050-11-H | | 50A | | | | |

Note: All types are designed to meet the requirement of UL 1283, CSA 22.2. VDE 0565-3
 Test voltage: 1500VAC one minute, line to ground
 Insulation resistance: 300 Mohm min. at 500VDC
 Leakage current: 0.7 mA max.
 Voltage drop: 1V max.
 Discharge time: 0.4 sec. max.
 Weight: 6.0 ounces (170 grams)

Power Line Filters Dual Stage

12-MMF & 12-MMB Series

Figure A



Figure B



Figure C



Figure D



Figure E



Figure F



Dimensions in inches (mm)

Common Mode



12-MMF/MMB-003;-006;-010;-012;-015

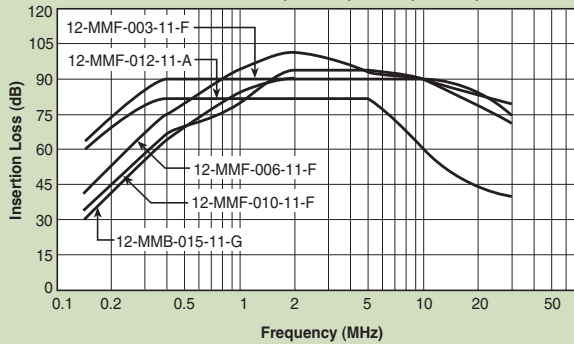

12-MMB-020;-030;-040;-050

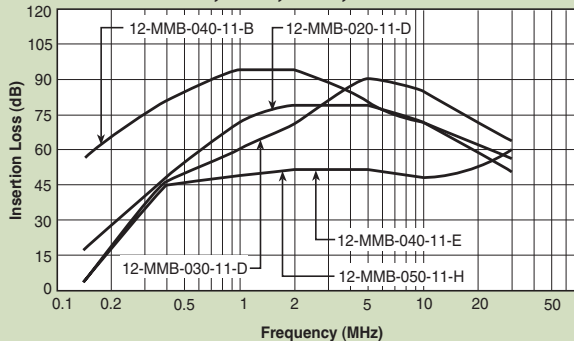

Normal Mode



12-MMF/MMB-003;-006;-010;-012;-015

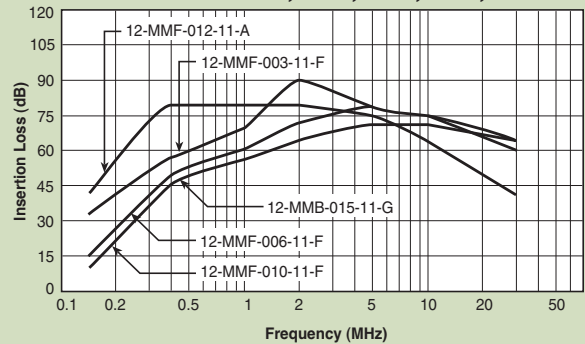

12-MMB-020;-030;-040;-050



Power Line Filters Dual Stage



12-MMF & 12-MMB Series

Features

- Suitable for products that must conform to FCC regulations
- Excellent attenuation for high voltage impulse
- Metal case provides effective EMI shielding
- Two stages for excellent filtering characteristics
- Epoxy molded for reliability
- Structure provides effective shielding for noise generated both externally and internally
- Operating temperature: -25°C to +85°C

Applications

- Digital equipment
- Personal computers and peripherals
- Measuring instruments and medical equipment
- Telecommunications equipment
- Equipment requiring very high noise attenuation

Circuit Diagram

Circuit 1



Circuit 2



Circuit 3



Specifications

| Model | Rated Voltage (@ 50/60Hz) | Rated Current | Leakage Current (Max.) | Circuit Diagram | Figure | Temperature Rise (Max.) | |
|----------------|---------------------------|---------------|------------------------|-----------------|--------|-------------------------|---|
| 12-MMF-001-5-F | 120/250VAC | 1A | 0.5mA | 3 | A | 30°C | |
| 12-MMF-003-5-G | | 3A | | | 5uA | | 1 |
| 12-MMF-003-2-G | | | 6A | | | | |
| 12-MMF-006-5-G | | 10A | 0.5mA | 2 | D | | |
| 12-MMB-010-5-D | | 15A | | | | | |
| 12-MMB-015-5-E | | 20A | | | | | |
| 12-MMB-020-5-E | | 30A | | | | | |
| 12-MMB-030-5-E | | | | | | | |

Note: All types are designed to meet the requirement of UL 1283, CSA 22.2. VDE 0565-3
 Test voltage: 1500VAC one minute, line to ground
 Insulation resistance: 300 Mohm min. at 500VDC
 Leakage current: 0.7 mA max.
 Voltage drop: 1V max.
 Discharge time: 0.4 sec. max.
 Weight: 6.0 ounces (170 grams)

Power Line Filters Dual Stage

12-MMF & 12-MMB Series

Figure A



Figure B



Figure C



Figure D



Dimensions in inches (mm)



Компания «Океан Электроники» предлагает заключение долгосрочных отношений при поставках импортных электронных компонентов на взаимовыгодных условиях!

Наши преимущества:

- Поставка оригинальных импортных электронных компонентов напрямую с производств Америки, Европы и Азии, а так же с крупнейших складов мира;
- Широкая линейка поставок активных и пассивных импортных электронных компонентов (более 30 млн. наименований);
- Поставка сложных, дефицитных, либо снятых с производства позиций;
- Оперативные сроки поставки под заказ (от 5 рабочих дней);
- Экспресс доставка в любую точку России;
- Помощь Конструкторского Отдела и консультации квалифицированных инженеров;
- Техническая поддержка проекта, помощь в подборе аналогов, поставка прототипов;
- Поставка электронных компонентов под контролем ВП;
- Система менеджмента качества сертифицирована по Международному стандарту ISO 9001;
- При необходимости вся продукция военного и аэрокосмического назначения проходит испытания и сертификацию в лаборатории (по согласованию с заказчиком);
- Поставка специализированных компонентов военного и аэрокосмического уровня качества (Xilinx, Altera, Analog Devices, Intersil, Interpoint, Microsemi, Actel, Aeroflex, Peregrine, VPT, Syfer, Eurofarad, Texas Instruments, MS Kennedy, Miteq, Cobham, E2V, MA-COM, Hittite, Mini-Circuits, General Dynamics и др.);

Компания «Океан Электроники» является официальным дистрибьютором и эксклюзивным представителем в России одного из крупнейших производителей разъемов военного и аэрокосмического назначения «JONHON», а так же официальным дистрибьютором и эксклюзивным представителем в России производителя высокотехнологичных и надежных решений для передачи СВЧ сигналов «FORSTAR».



JONHON

«JONHON» (основан в 1970 г.)

Разъемы специального, военного и аэрокосмического назначения:

(Применяются в военной, авиационной, аэрокосмической, морской, железнодорожной, горно- и нефтедобывающей отраслях промышленности)

«FORSTAR» (основан в 1998 г.)

ВЧ соединители, коаксиальные кабели, кабельные сборки и микроволновые компоненты:

(Применяются в телекоммуникациях гражданского и специального назначения, в средствах связи, РЛС, а так же военной, авиационной и аэрокосмической отраслях промышленности).



Телефон: 8 (812) 309-75-97 (многоканальный)

Факс: 8 (812) 320-03-32

Электронная почта: ocean@oceanchips.ru

Web: <http://oceanchips.ru/>

Адрес: 198099, г. Санкт-Петербург, ул. Калинина, д. 2, корп. 4, лит. А