

RB-Series SiPM Sensors



ON Semiconductor®

www.onsemi.com

Advance Information Silicon Photomultipliers (SiPM), Red-Enhanced Second Generation

RB-Series sensors are the second release of Silicon Photomultipliers (SiPM) from ON Semiconductor's R-Series range. These sensors provide further sensitivity improvements in the red and NIR region of the electromagnetic spectrum. All R-Series SiPM sensors feature high responsivity, fast signal response and a low temperature coefficient of operating voltage, all achieved at a low bias voltage. The sensor is packaged in a compact and robust MLP (molded lead frame) package that is suitable for reflow solder processes. Both the sensor and the package are designed for volume production with the product delivered on tape and reel.

SiPM sensors are an improvement over avalanche photodiodes (APD) and PIN diodes due to their high gain and single photon sensitivity. This enables the detection of low reflectivity targets at very long distance in LiDAR applications. Unlike the similarly-operated SPAD that can only detect single photons, the SiPM overcomes this limitation by incorporating a 'microcell' structure that allows for multi-photon detection with a high dynamic range. It is strongly recommended that those new to SiPM sensors consult the [Introduction to Silicon Photomultipliers](#) application note.

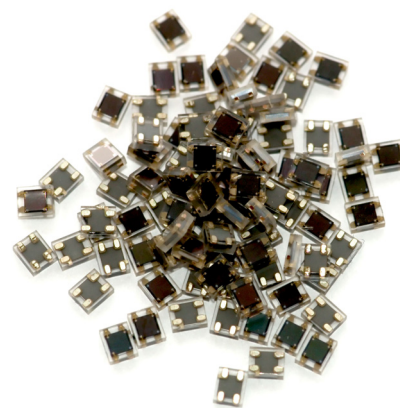

ORDERING INFORMATION

See detailed ordering and shipping information on page 10 of this data sheet.

Table 1. GENERAL PARAMETERS

Parameter (Note 1)	Microcell Size	Minimum	Typical	Maximum	Unit
Breakdown Voltage (Vbr) (Notes 2, 3, 4)	10 μm		27		V
	20 μm		23		
	35 μm		25		
Overvoltage (Vov) (Notes 2, 4)	10 μm		20	20	V
	20 μm		10	15	
	35 μm		7	10	
Spectral Range (Note 5)		300		1050	nm

- All measurements made at 21°C unless otherwise stated.
- Operating bias (Vbias) = Vbr + Vov
- The breakdown voltage (Vbr) is defined as the value of the voltage intercept of a straight line fit to a plot of \sqrt{I} vs V, where I is the current and V is the bias voltage.
- Specific Vbr and Vov information for a given lot is available in the [lot release note](#). The lot number is given on the product packaging.
- Range at which the maximum PDE is > 1%.

Table 2. PHYSICAL PARAMETERS

Parameter	10010	10020	10035
Active Area	1 mm × 1 mm		
Microcell Size	10 μm × 10 μm	20 μm × 20 μm	35 μm × 35 μm
Number of Microcells	4296	1590	620
Microcell Fill Factor	43%	63%	76%

This document contains information on a new product. Specifications and information herein are subject to change without notice.

RB-Series SiPM Sensors

Table 3. PERFORMANCE PARAMETERS

Parameter (Note 6)	10010	10020	10035	Unit
PDE @ 905 nm @ Maximum Overvoltage (Notes 7, 8)	4.0	7.3	10.3	%
PDE @ 905 nm @ Typical Overvoltage (Notes 6, 7)	4.0	5.6	9.1	%
Responsivity @ 905 nm @ Maximum Overvoltage (Note 8)	52	270	420	kA/W
Responsivity @ 905 nm @ Typical Overvoltage (Note 6)	52	61	240	kA/W
Gain – Cathode-anode Output (Note 6)	0.7×10^6	0.9×10^6	1.7×10^6	
Dark Count Rate (Notes 6, 9)	2.5	2.7	2.6	MHz
Dark Current (Note 6)	0.52	0.54	1.5	μ A
Rise Time – Standard Output (Notes 6, 10)	1.5	1.0	0.9	ns
Microcell Recharge Time Constant (Notes 6, 10, 11)	12	21	73	ns
Rise Time – Fast Output (Notes 6, 10)	490	490	490	ps
Fast Output Pulse Width (FWHM) (Notes 6, 10)	2.3	2.0	3.7	ns
Crosstalk (Note 6, 12)	30	22	43	%
Afterpulsing (Note 6)	13	6	1	%
Excess Noise Factor (Note 6)	1.34	1.19	1.22	
Temperature Coefficient of Vbr		See page 5		

6. All measurements made at 21°C and 'Typical' overvoltage (see page 1) unless otherwise specified.
7. PDE (Photon Detection Efficiency) is the product of the QE * AIP * FF, where QE is quantum efficiency, AIP is the avalanche initiation probability and FF is the fill factor of the microcells.
8. Measured at maximum overvoltage.
9. Each thermally generated 'noise' carrier in the active volume of the sensor will generate a signal equal to that of a single photon. The rate of these spurious counts is referred to as the dark count rate.
10. All timing measurements acquired using a ON Semiconductor SMA board, see page 6.
11. RC charging time constant of the microcell (τ).
12. A lower overvoltage can be used to achieve lower crosstalk.

Table 4. PACKAGE PARAMETERS

Parameter	10010	10020	10035
Package Dimensions	1.5 mm × 1.8 mm		
Soldering Conditions	Lead-free, reflow soldering process compatible. See the SMT Handling application note for more details		
Encapsulant Type	Clear transfer molding compound		
Encapsulant Refractive Index	1.57 @ 589 nm		
Moisture Sensitivity Level (MSL)	MSL 3 for tape & reel (TR) MSL 4 for tape only (TR1)		

Table 5. ABSOLUTE MAXIMUM RATINGS

Rating	10010	10020	10035
Maximum Average Current	3 mA		
Recommended Operating Temperature Range	-40°C to +85°C		
Maximum Storage Temperature	105°C		

Stresses exceeding those listed in the Maximum Ratings table may damage the device. If any of these limits are exceeded, device functionality should not be assumed, damage may occur and reliability may be affected.

RB-Series SiPM Sensors

PERFORMANCE PLOTS

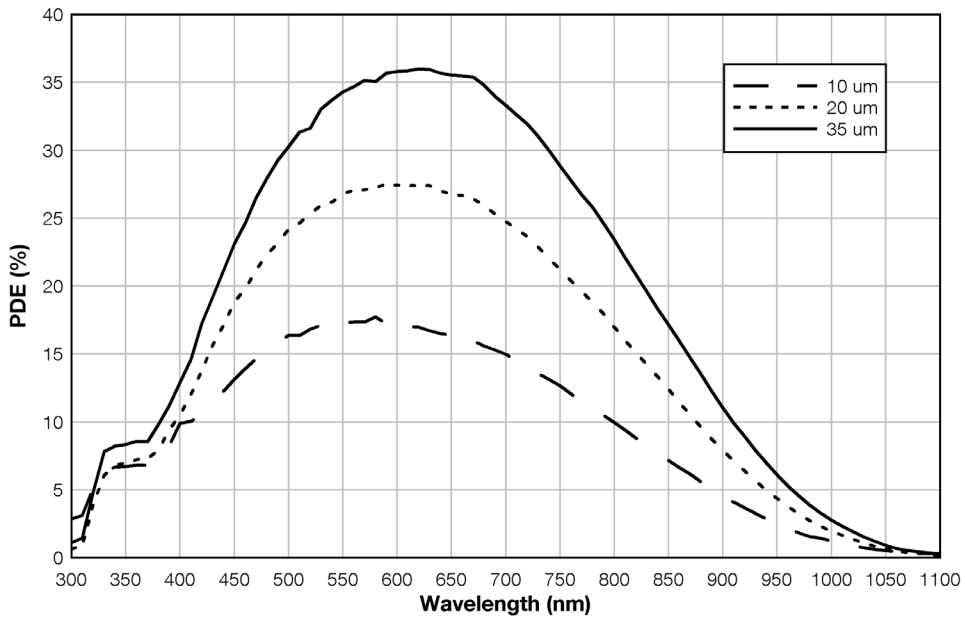

Figure 1. PDE vs. Wavelength
(MICRORB-10010, MICRORB-10020, MICRORB-10035 @ Maximum Overvoltage)

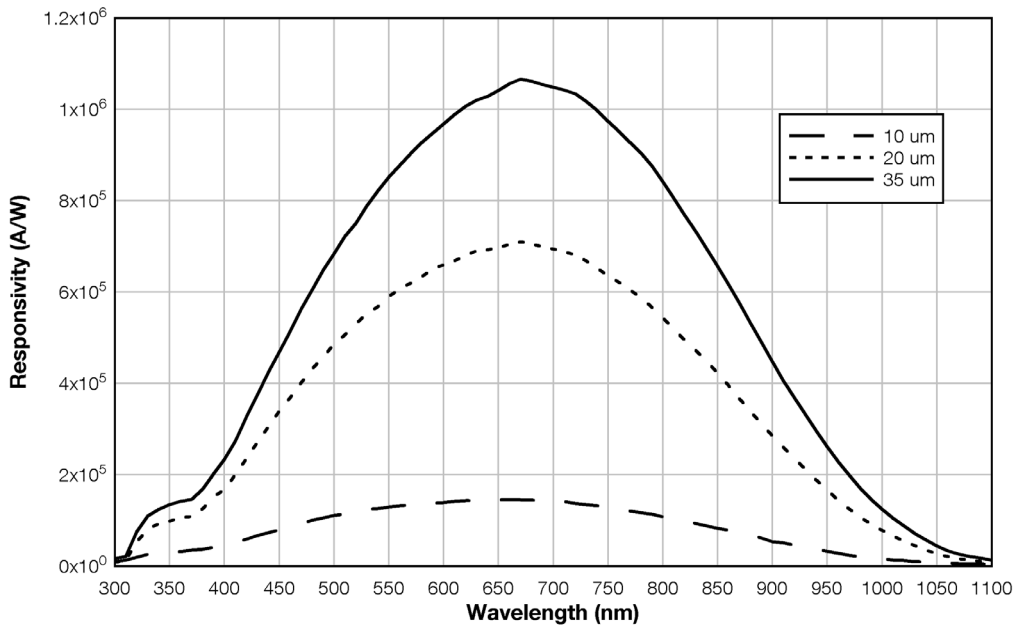

Figure 2. Responsivity vs. Wavelength
(MICRORB-10010, MICRORB-10020, MICRORB-10035 @ Maximum Overvoltage)

RB-Series SiPM Sensors

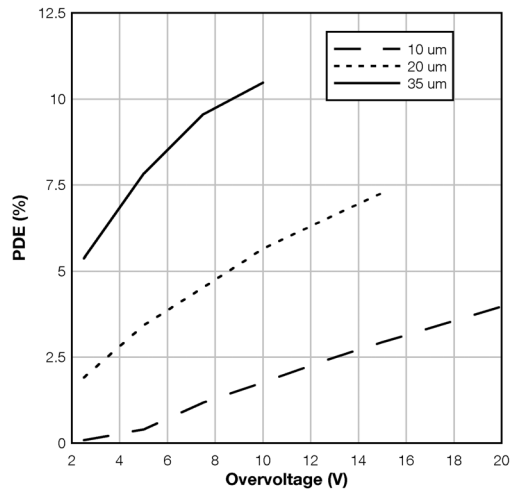

Figure 3. PDE vs. Overvoltage
(MICRORB-10010, MICRORB-10020, MICRORB-10035 @ 905 nm)

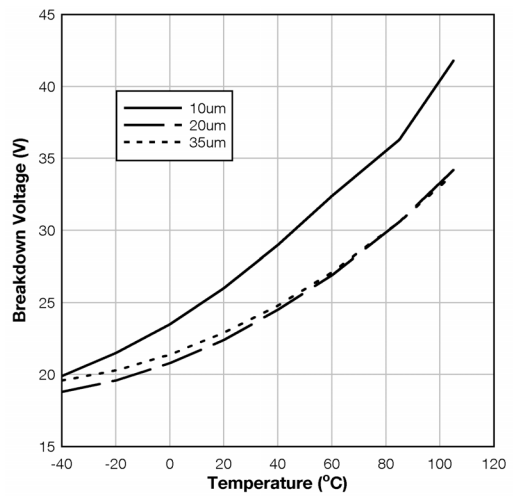

Figure 5. Breakdown Voltage vs. Temperature
(MICRORB-10010, MICRORB-10020, MICRORB-10035)

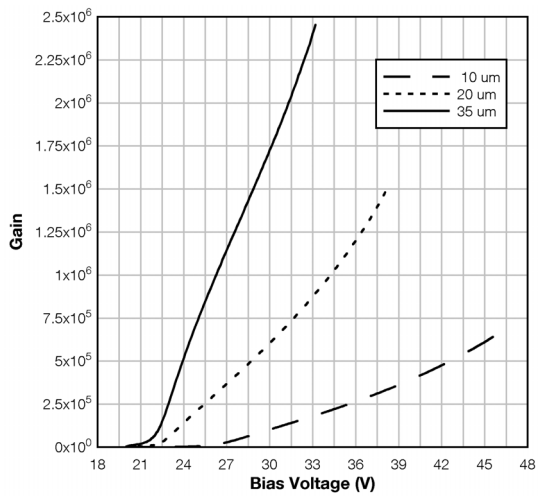

Figure 4. Gain vs. Bias Voltage
(MICRORB-10010, MICRORB-10020, MICRORB-10035)

RB-Series SiPM Sensors

Temperature Coefficient of Breakdown Voltage

The RB-Series breakdown voltage has a non-linear relationship with temperature. The plots below show typical behavior for each microcell size. Please contact ON Semiconductor Sales for more information.

Pulse Shape

The measurement of the pulse shapes below were acquired using a ON Semiconductor SMA board (see page 6) with a 50 ps pulse from a 420 nm laser. The laser is set to a level that illuminates 10–15% of the microcells to ensure that the SiPM is in the linear range of operation.

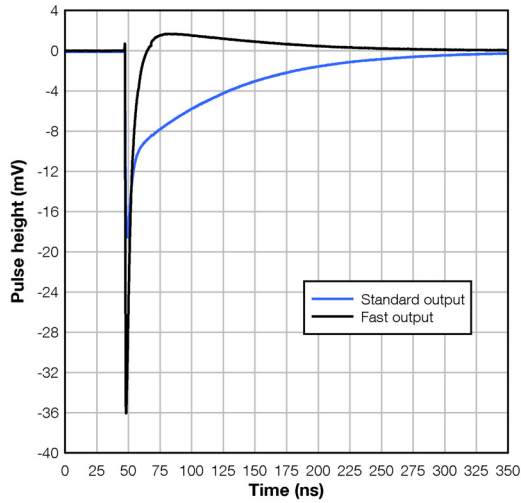

Figure 6. Pulse Shape
(MICRORB-10035)

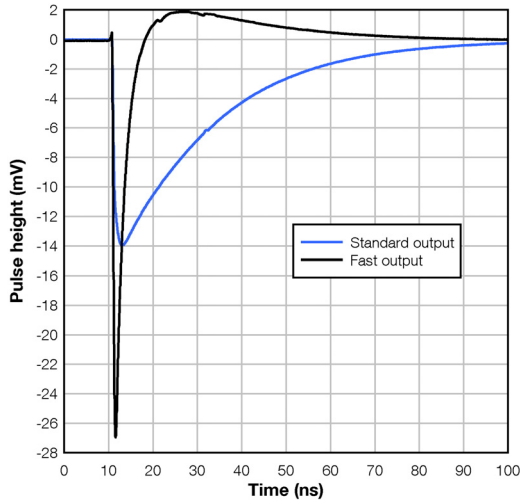

Figure 7. Pulse Shape
(MICRORB-10020)

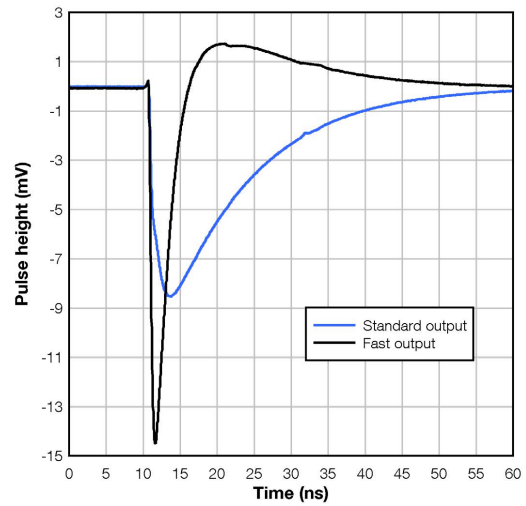
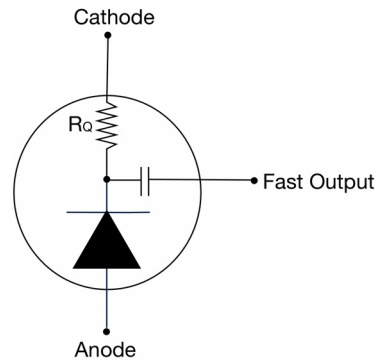

Figure 8. Pulse Shape
(MICRORB-10010)

NOTE: MICRORB sensors use an N-on-P diode and therefore have a different fast pulse polarity compared to ON Semiconductor P-on-N sensors i.e. C-Series, although the pin-out is the same.



RB-Series SiPM Sensors

EVALUATION BOARDS

SMA BIASING BOARD (MICRORB-SMA-100XX)

The MICRORB-SMA is a printed circuit board (PCB) that can facilitate the evaluation of the MICRORB MLP sensors. The board has three female SMA connectors for connecting the bias voltage, the standard output from the cathode and the fast output signal. The output signals can be connected directly to a 50 Ω -terminated oscilloscope for viewing. The biasing and output signal tracks are laid out in such a way as to preserve the fast timing characteristics of the sensor.

The MICRORB-SMA is recommended for users who require a plug-and-play set-up to quickly evaluate MICRORB sensors with optimum timing performance. The board also allows the signal from the cathode-anode readout to be observed at the same time as the fast output. The outputs can be connected directly to the oscilloscope or measurement device, but external preamplification may be required to boost the signal. The table below lists the SMA

board connections. The SMA board electrical schematics are available to download in the [Board Reference Design](#) document.

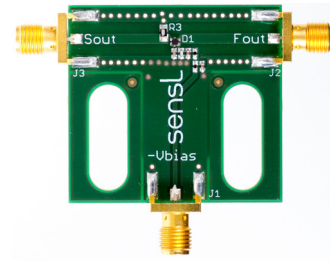

MICRORB-SMA-100XX	
Output	Function
Vbias	Negative bias input (anode)
Fout	Fast output
Sout	Standard output (cathode)

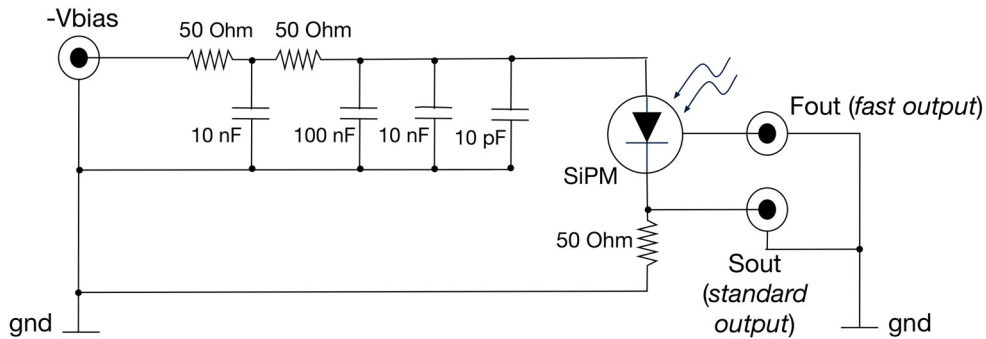

Figure 9. SMA Board Circuit Schematic

RB-Series SiPM Sensors

PIN ADAPTER BOARD (MICRORB-SMTPA-100XX)

The Pin Adapter board (SMTPA) is a small PCB board that houses the SiPM sensor and has through-hole pins to allow its use with standard sockets or probe clips. This product is useful for those needing a quick way to evaluate the MLP-packaged sensor without the need for specialist surface-mount soldering. While this is a 'quick fix' suitable for many evaluations, it should be noted that the timing performance from this board will not be optimized and if the best possible timing performance is required, the MICRORB-SMA-100XX is recommended. The SMTPA circuit schematic is shown below. Please consult the [Biasing and Readout](#) Application Note for further information on biasing. The SMTPA board electrical schematics are available to download in the [Board Reference Design](#) document.

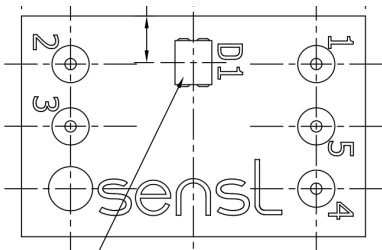
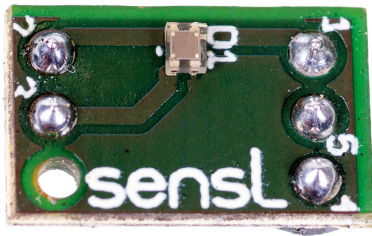

Figure 10. Top View of the SMTPA Board Showing the Pin Numbering

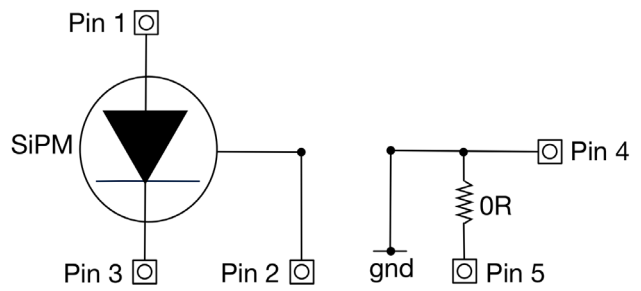

Figure 11. SMTPA Board Circuit Schematic

MICRORB-SMTPA-100XX	
Pin No.	Connection
1	Anode
2	Fast output
3	Cathode
4	Ground
5	Ground

RB-Series SiPM Sensors

PACKAGE DIMENSIONS

(All Dimensions in mm)

MICRORB-100XX-MLP

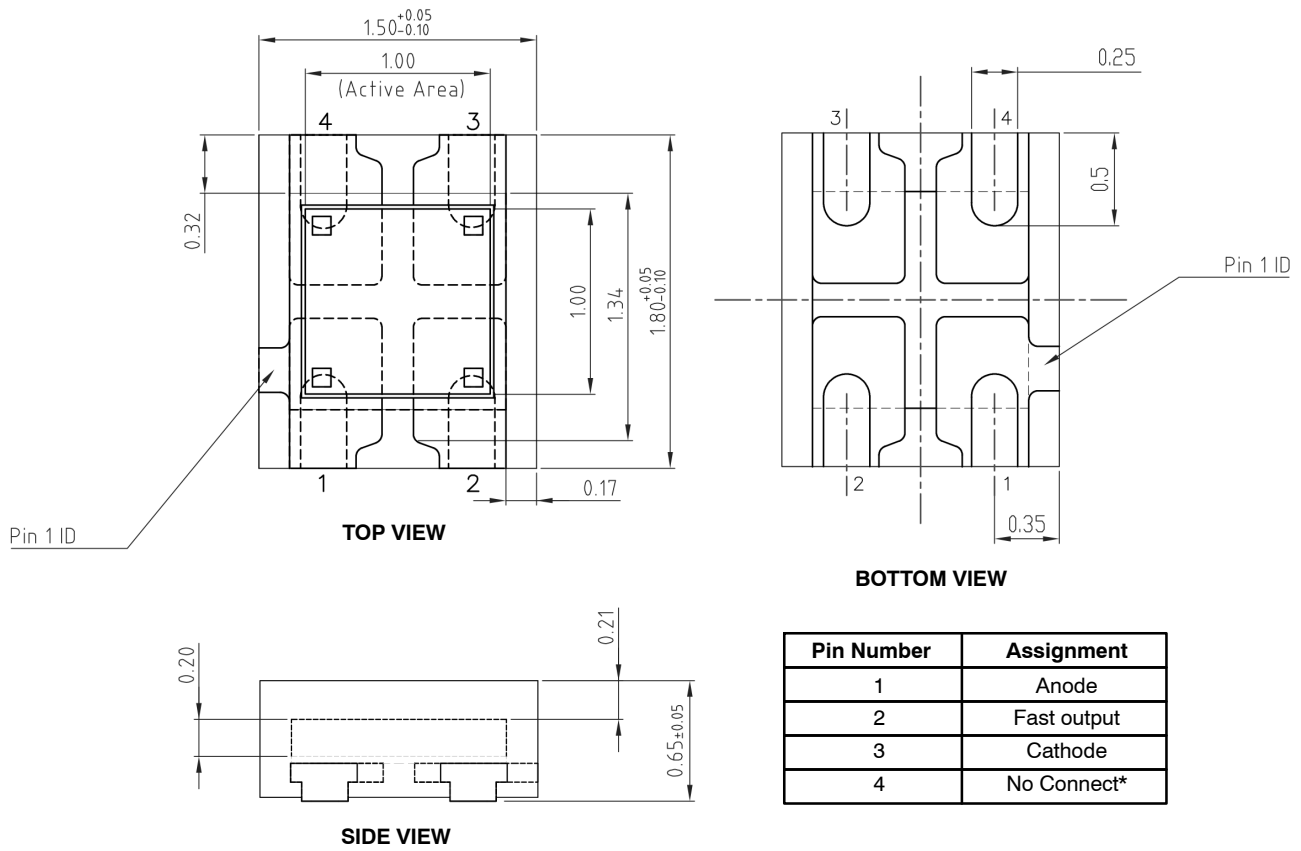

*The 'No Connect' pins are electrically isolated and should be soldered to a ground (or bias) plane to help with heat dissipation.

The CAD file for the MICRORB-100XX-MLP package and tape and reel, and the solder footprint is available to download [here](#).

RB-Series SiPM Sensors

MICRORB-SMA-100XX

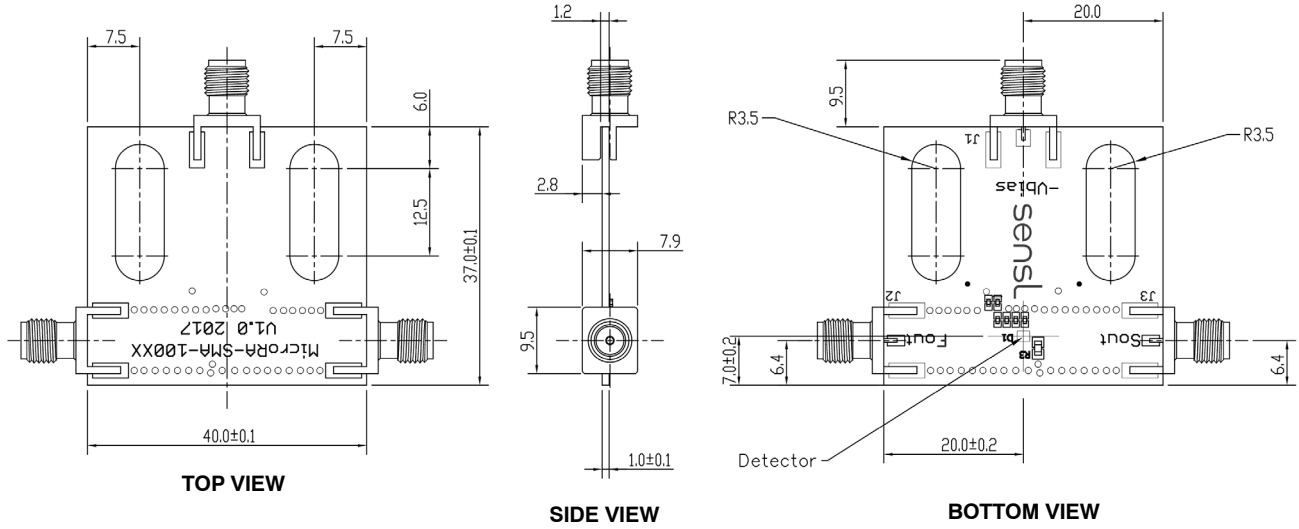

The complete MICRORB-SMA-100XX CAD file is available to download [here](#).

MICRORB-SMTPA-100XX

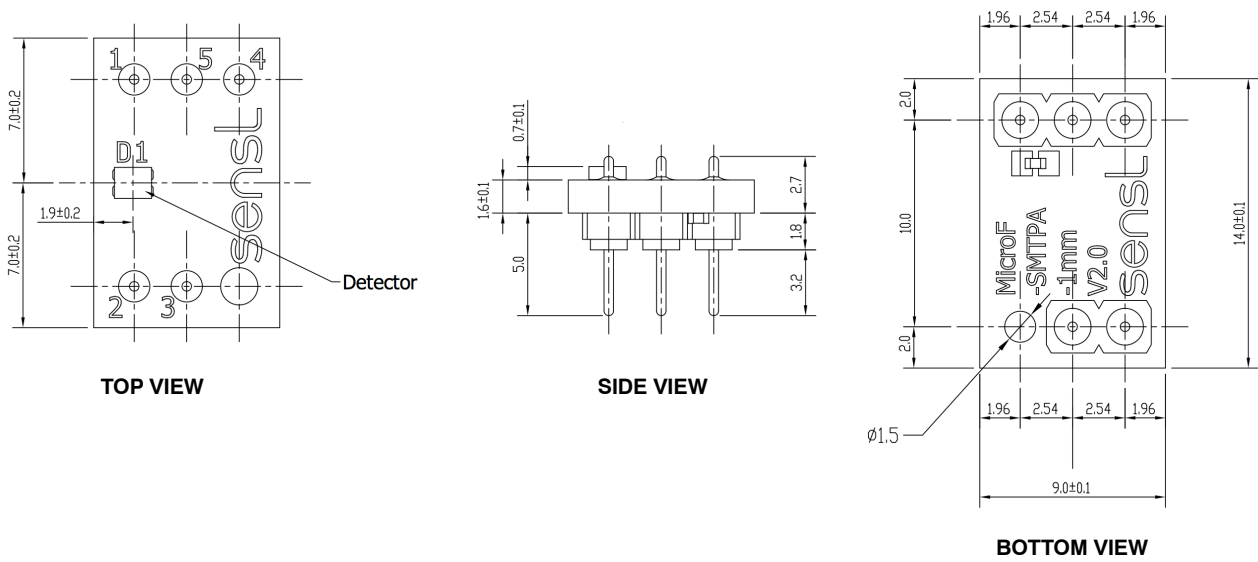

The complete MICRORB-SMTPA-100XX CAD file is available to download [here](#).

RB-Series SiPM Sensors

USEFUL LINKS

- [Introduction to Silicon Photomultipliers Application Note](#) – If you are new to SiPM, this document explains their operation and main performance parameters.
- [Biasing and Readout Application Note](#) – This document gives detailed information on how to bias the sensor for both standard and fast configurations, and amplifying and reading out the signal.
- [How to Evaluate and Compare Silicon Photomultipliers Application Note](#) – Information on what to consider when selecting an SiPM.
- [Handling and Soldering Guide](#) – This document gives information on safe handling of the sensors and soldering to PCB.
- [ON Semiconductor Website](#) – for more information on all of ON Semiconductor’s products as well as application information.
- [CAD file library](#) – ON Semiconductor CAD files.

ORDERING INFORMATION

Table 6. ORDERING INFORMATION

Product Code	Microcell Size	Sensor Active Area	Package Description	Delivery Option (Note 13)
MICRORB-10010-MLP	10 μm	$1 \times 1 \text{ mm}^2$	4-side tileable, surface mount, molded leadframe package (MLP)	TR1, TR
MICRORB-SMA-10010-GEVB			MLP sensor mounted onto a PCB with SMA connectors for bias and output.	PK
MICRORB-SMTPA-10010-GEVB			MLP packaged sensor mounted onto a pin adapter board.	PK
MICRORB-10020-MLP	20 μm		4-side tileable, surface mount, molded leadframe package (MLP)	TR1, TR
MICRORB-SMA-10020-GEVB			MLP sensor mounted onto a PCB with SMA connectors for bias and output.	PK
MICRORB-SMTPA-10020-GEVB			MLP packaged sensor mounted onto a pin adapter board.	PK
MICRORB-10035-MLP	35 μm		4-side tileable, surface mount, molded leadframe package (MLP)	TR1, TR
MICRORB-SMA-10035-GEVB			MLP sensor mounted onto a PCB with SMA connectors for bias and output.	PK
MICRORB-SMTPA-10035-GEVB			MLP packaged sensor mounted onto a pin adapter board.	PK

13. The two-letter delivery option code should be appended to the order number, e.g.) to receive a MICRORB-10035-MLP on cut tape, use MICRORB-10035-MLP-TA. The codes are as follows:

PK = ESD Package
 TR1 = Tape
 TR = Tape and Reel

There is a minimum order quantity (MOQ) of 3000 for the tape and reel (TR) option. Quantities less than this are available on tape (-TR1). The TR option is only available in multiples of the MOQ.

For information on the availability of automotive qualified versions of these parts, please contact sales@onsemi.com

RB-Series SiPM Sensors

SensL is a registered trademark of of Semiconductor Components Industries, LLC (SCILLC) or its subsidiaries in the United States and/or other countries.

ON Semiconductor and  are trademarks of Semiconductor Components Industries, LLC dba ON Semiconductor or its subsidiaries in the United States and/or other countries. ON Semiconductor owns the rights to a number of patents, trademarks, copyrights, trade secrets, and other intellectual property. A listing of ON Semiconductor's product/patent coverage may be accessed at www.onsemi.com/site/pdf/Patent-Marking.pdf. ON Semiconductor reserves the right to make changes without further notice to any products herein. ON Semiconductor makes no warranty, representation or guarantee regarding the suitability of its products for any particular purpose, nor does ON Semiconductor assume any liability arising out of the application or use of any product or circuit, and specifically disclaims any and all liability, including without limitation special, consequential or incidental damages. Buyer is responsible for its products and applications using ON Semiconductor products, including compliance with all laws, regulations and safety requirements or standards, regardless of any support or applications information provided by ON Semiconductor. "Typical" parameters which may be provided in ON Semiconductor data sheets and/or specifications can and do vary in different applications and actual performance may vary over time. All operating parameters, including "Typicals" must be validated for each customer application by customer's technical experts. ON Semiconductor does not convey any license under its patent rights nor the rights of others. ON Semiconductor products are not designed, intended, or authorized for use as a critical component in life support systems or any FDA Class 3 medical devices or medical devices with a same or similar classification in a foreign jurisdiction or any devices intended for implantation in the human body. Should Buyer purchase or use ON Semiconductor products for any such unintended or unauthorized application, Buyer shall indemnify and hold ON Semiconductor and its officers, employees, subsidiaries, affiliates, and distributors harmless against all claims, costs, damages, and expenses, and reasonable attorney fees arising out of, directly or indirectly, any claim of personal injury or death associated with such unintended or unauthorized use, even if such claim alleges that ON Semiconductor was negligent regarding the design or manufacture of the part. ON Semiconductor is an Equal Opportunity/Affirmative Action Employer. This literature is subject to all applicable copyright laws and is not for resale in any manner.

PUBLICATION ORDERING INFORMATION

LITERATURE FULFILLMENT:

Literature Distribution Center for ON Semiconductor
19521 E. 32nd Pkwy, Aurora, Colorado 80011 USA
Phone: 303-675-2175 or 800-344-3860 Toll Free USA/Canada
Fax: 303-675-2176 or 800-344-3867 Toll Free USA/Canada
Email: orderlit@onsemi.com

N. American Technical Support: 800-282-9855 Toll Free
USA/Canada
Europe, Middle East and Africa Technical Support:
Phone: 421 33 790 2910

ON Semiconductor Website: www.onsemi.com

Order Literature: <http://www.onsemi.com/orderlit>

For additional information, please contact your local Sales Representative

Компания «Океан Электроники» предлагает заключение долгосрочных отношений при поставках импортных электронных компонентов на взаимовыгодных условиях!

Наши преимущества:

- Поставка оригинальных импортных электронных компонентов напрямую с производств Америки, Европы и Азии, а так же с крупнейших складов мира;
- Широкая линейка поставок активных и пассивных импортных электронных компонентов (более 30 млн. наименований);
- Поставка сложных, дефицитных, либо снятых с производства позиций;
- Оперативные сроки поставки под заказ (от 5 рабочих дней);
- Экспресс доставка в любую точку России;
- Помощь Конструкторского Отдела и консультации квалифицированных инженеров;
- Техническая поддержка проекта, помощь в подборе аналогов, поставка прототипов;
- Поставка электронных компонентов под контролем ВП;
- Система менеджмента качества сертифицирована по Международному стандарту ISO 9001;
- При необходимости вся продукция военного и аэрокосмического назначения проходит испытания и сертификацию в лаборатории (по согласованию с заказчиком);
- Поставка специализированных компонентов военного и аэрокосмического уровня качества (Xilinx, Altera, Analog Devices, Intersil, Interpoint, Microsemi, Actel, Aeroflex, Peregrine, VPT, Syfer, Eurofarad, Texas Instruments, MS Kennedy, Miteq, Cobham, E2V, MA-COM, Hittite, Mini-Circuits, General Dynamics и др.);

Компания «Океан Электроники» является официальным дистрибьютором и эксклюзивным представителем в России одного из крупнейших производителей разъемов военного и аэрокосмического назначения «**JONHON**», а так же официальным дистрибьютором и эксклюзивным представителем в России производителя высокотехнологичных и надежных решений для передачи СВЧ сигналов «**FORSTAR**».



JONHON

«**JONHON**» (основан в 1970 г.)

Разъемы специального, военного и аэрокосмического назначения:

(Применяются в военной, авиационной, аэрокосмической, морской, железнодорожной, горно- и нефтедобывающей отраслях промышленности)

«**FORSTAR**» (основан в 1998 г.)

ВЧ соединители, коаксиальные кабели,
кабельные сборки и микроволновые компоненты:

(Применяются в телекоммуникациях гражданского и специального назначения, в средствах связи, РЛС, а так же военной, авиационной и аэрокосмической отраслях промышленности).



Телефон: 8 (812) 309-75-97 (многоканальный)

Факс: 8 (812) 320-03-32

Электронная почта: ocean@oceanchips.ru

Web: <http://oceanchips.ru/>

Адрес: 198099, г. Санкт-Петербург, ул. Калинина, д. 2, корп. 4, лит. А