

**1A 3-TERMINAL POSITIVE VOLTAGE REGULATOR****AS7805A****General Description**

The AS7805A is a three terminal positive regulator designed for a wide variety of applications including local, on-card regulation.

The AS7805A is complete with internal current limiting, thermal shutdown protection, and safe-area compensation which make it virtually immune from output overload. If adequate heat sinking is provided, this IC can deliver output current up to 1A.

The AS7805A is available in TO-220-3 and TO-252-2 (1) packages.

Features

- Output Current up to 1A
- Fixed Output Voltage of 5V
- Output Voltage Accuracy of $\pm 4\%$ over the Full Temperature Range
- Internal Short Circuit Current Limiting
- Internal Thermal Overload Protection
- Output Transistor Safe-area Protection
- Low Load Regulation
- Stable Performance in High Temperature

Applications

- High Efficiency Linear Regulator
- Post Regulation for Switching Supply
- Microprocessor Power Supply
- Mother Board

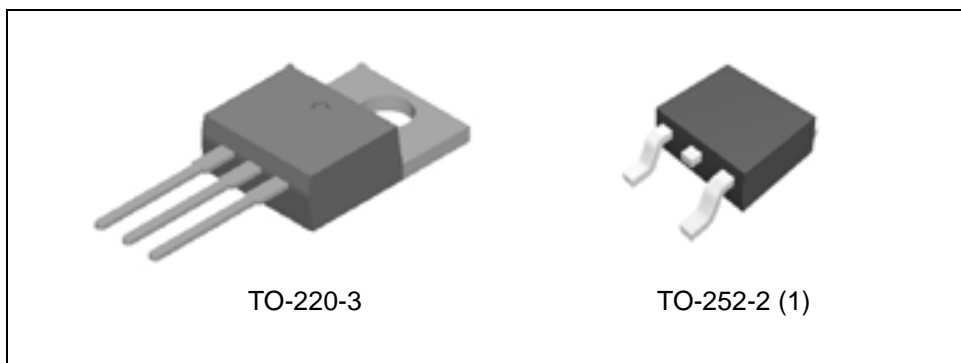

Figure 1. Package Types of AS7805A



1A 3-TERMINAL POSITIVE VOLTAGE REGULATOR

AS7805A

Pin Configuration

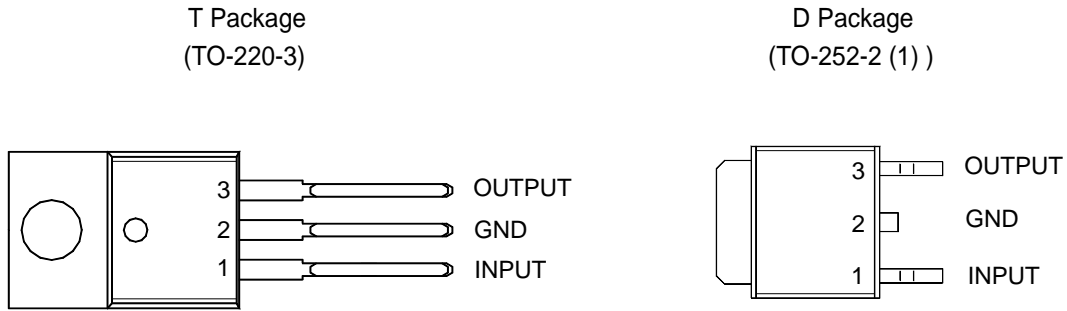

Figure 2. Pin Configuration of AS7805A (Top View)

Pin Description

Pin Number	Pin Name	Function
1	INPUT	Voltage Input
2	GND	Ground
3	OUTPUT	Voltage Output



1A 3-TERMINAL POSITIVE VOLTAGE REGULATOR

AS7805A

Functional Block Diagram

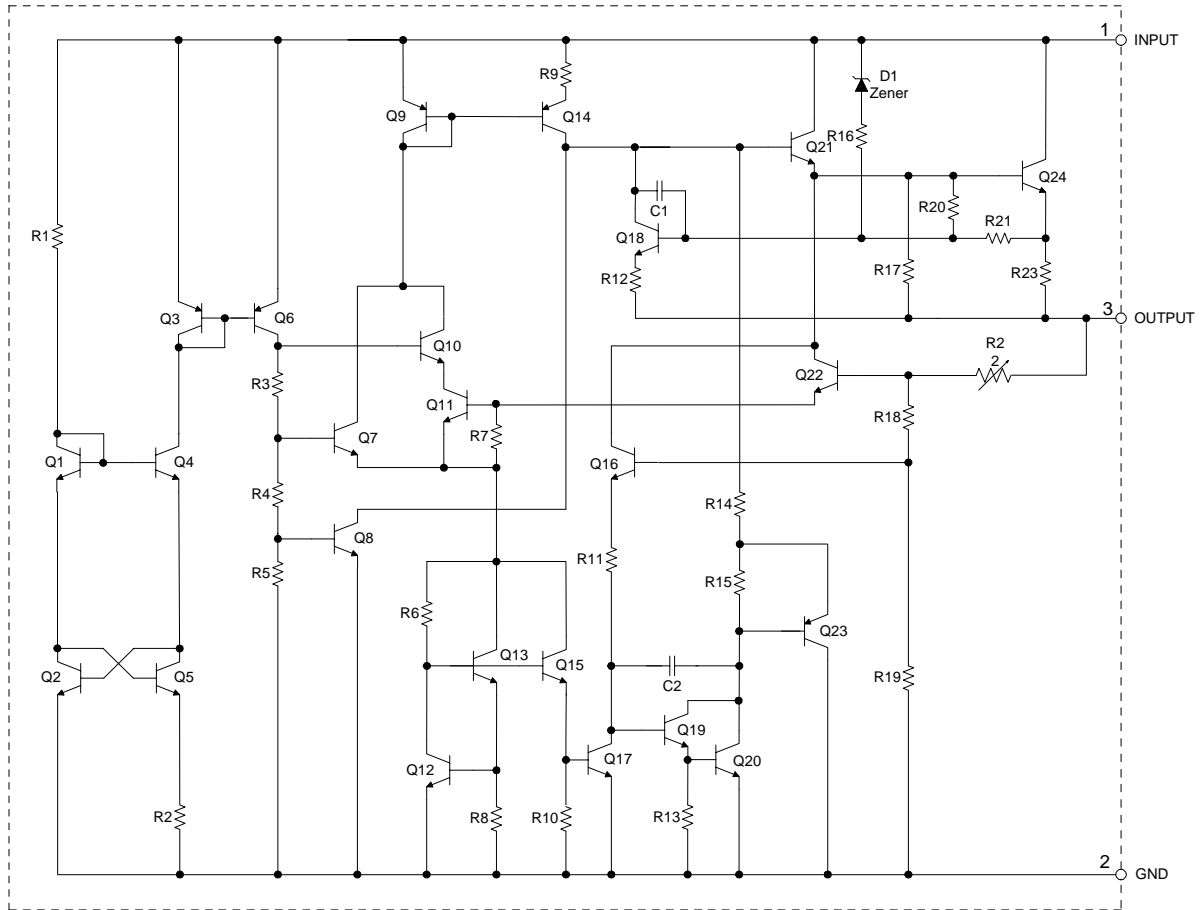
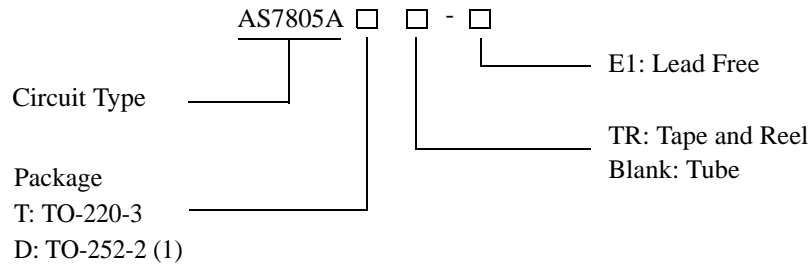

Figure 3. Functional Block Diagram of AS7805A



1A 3-TERMINAL POSITIVE VOLTAGE REGULATOR AS7805A

Ordering Information



Package	Temperature Range	Part Number	Marking ID	Packing Type
TO-220-3	-40 to 125°C	AS7805AT-E1	AS7805AT-E1	Tube
TO-252-2 (1)	-40 to 125°C	AS7805AD-E1	AS7805AD-E1	Tube
		AS7805ADTR-E1	AS7805AD-E1	Tape & Reel

BCD Semiconductor's Pb-free products, as designated with "E1" suffix in the part number, are RoHS compliant.

**1A 3-TERMINAL POSITIVE VOLTAGE REGULATOR****AS7805A****Absolute Maximum Ratings (Note 1)**

Parameter	Symbol	Value		Unit
Input Voltage	V_{IN}	36		V
Lead Temperature (Soldering, 10sec)	T_{LEAD}	260		°C
Power Dissipation	P_D	Internally Limited		W
Operating Junction Temperature	T_J	150		°C
Storage Temperature Range	T_{STG}	-65 to 150		°C
Thermal Resistance	θ_{JA}	TO-220-3	60	°C/W
		TO-252-2 (1)	100	
ESD (Human Body Model)	ESD	6000		V
ESD (Machine Model)	ESD	500		V

Note 1: Stresses greater than those listed under "Absolute Maximum Ratings" may cause permanent damage to the device. These are stress ratings only, and functional operation of the device at these or any other conditions beyond those indicated under "Recommended Operating Conditions" is not implied. Exposure to "Absolute Maximum Ratings" for extended periods may affect device reliability.

Recommended Operating Conditions

Parameter	Symbol	Min	Max	Unit
Input Voltage	V_{IN}		25	V
Operating Junction Temperature Range	T_J	-40	125	°C



1A 3-TERMINAL POSITIVE VOLTAGE REGULATOR AS7805A

Electrical Characteristics

$V_{IN}=10V, I_{OUT}=1A, T_J=-40$ to $125^{\circ}C$, unless otherwise specified.

Parameter	Symbol	Conditions	Min	Typ	Max	Unit
Output Voltage	V_{OUT}	$T_J=25^{\circ}C$	4.9	5	5.1	V
		$I_{OUT}=5mA$ to $1A, V_{IN}=7.5V$ to $20V, P_D \leq 15W$	4.8		5.2	
Line Regulation	V_{RLINE}	$V_{IN}=7.5V$ to $20V, I_{OUT}=500mA, T_J=25^{\circ}C$		25	50	mV
		$V_{IN}=7.5V$ to $20V, I_{OUT}=500mA, T_J=75^{\circ}C$		15	40	mV
Load Regulation	V_{RLOAD}	$V_{IN}=10V, I_{OUT}=5mA$ to $1A, T_J=25^{\circ}C$		20	50	mV
Quiescent Current	I_Q	$V_{IN}=10V, I_{OUT}=0$		3.2	6	mA
Quiescent Current Change	ΔI_Q	$V_{IN}=8V$ to $25V, I_{OUT}=500mA, T_J=25^{\circ}C$		0.3	0.8	mA
		$I_{OUT}=5mA$ to $1A, T_J=25^{\circ}C$		0.08	0.5	
Ripple Rejection	PSRR	$V_{IN}=8V$ to $18V, f=120Hz, I_{OUT}=500mA$		70		dB
Dropout Voltage	V_{DROP}	$\Delta V_{OUT}=1\%, I_{OUT}=1A, T_J=25^{\circ}C$		2		V
Output Noise Voltage	N_O	$f=10Hz$ to $100kHz, T_A=25^{\circ}C$		10		$\mu V/V_O$
Output Resistance	R_O	$f=1kHz$		10		$m\Omega$
Short Circuit Current	I_{SC}	$V_{IN}=35V, T_A=25^{\circ}C$		0.05		A
Peak Output Current	I_{PK}	$V_{IN}=10V, T_J=25^{\circ}C$		2.2		A
Output Voltage Temperature Coefficient	$\Delta V_{OUT}/\Delta T$			0.4		$mV/^{\circ}C$
	$(\Delta V_{OUT}/V_{OUT})/\Delta T$			80		ppm/ $^{\circ}C$



1A 3-TERMINAL POSITIVE VOLTAGE REGULATOR

AS7805A

Typical Performance Characteristics

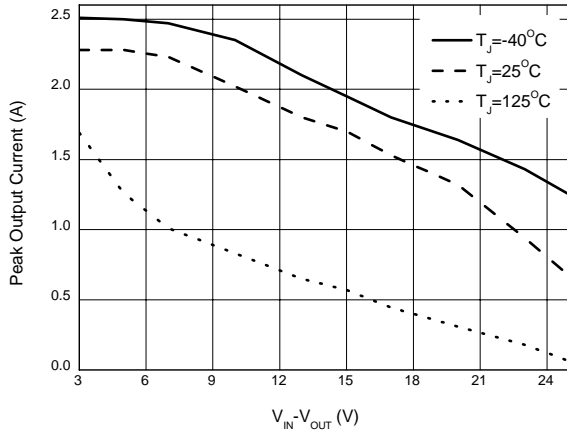

Figure 4. Peak Output Current vs. Input/Output Differential Voltage

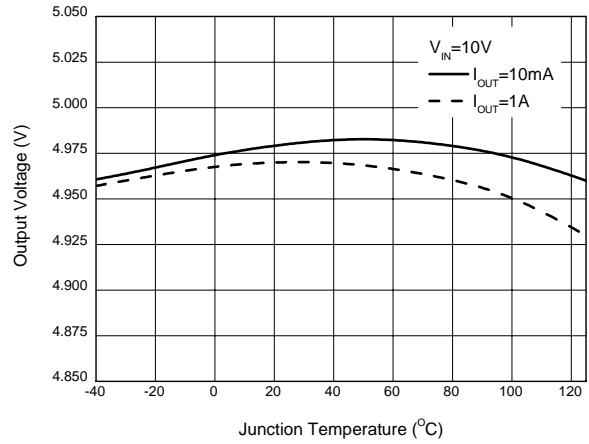

Figure 5. Output Voltage vs. Junction Temperature

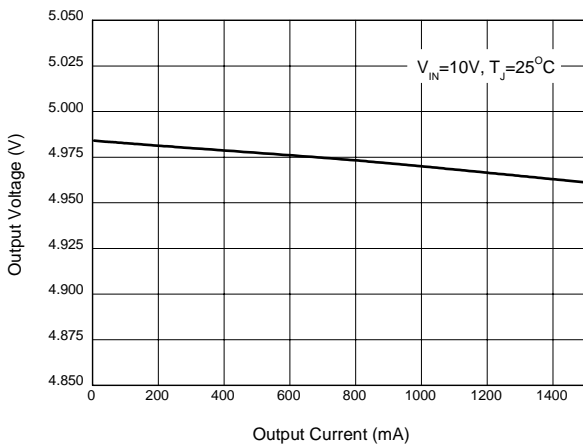

Figure 6. Output Voltage vs. Output Current

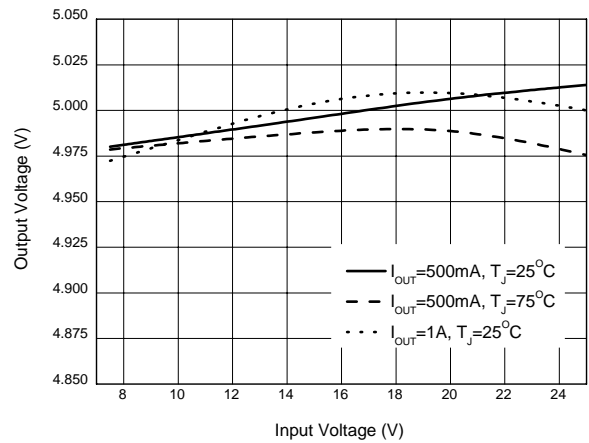

Figure 7. Output Voltage vs. Input Voltage



1A 3-TERMINAL POSITIVE VOLTAGE REGULATOR

AS7805A

Typical Performance Characteristics (Continued)

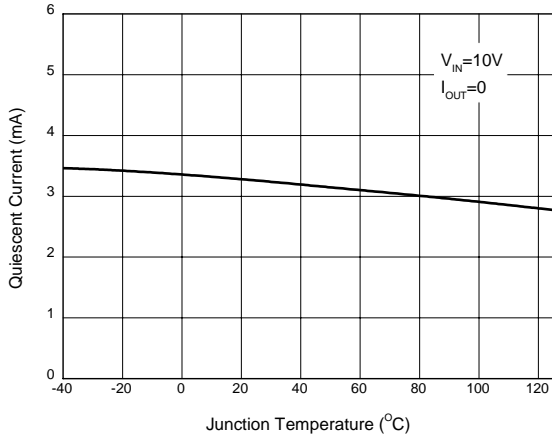

Figure 8. Quiescent Current vs. Junction Temperature

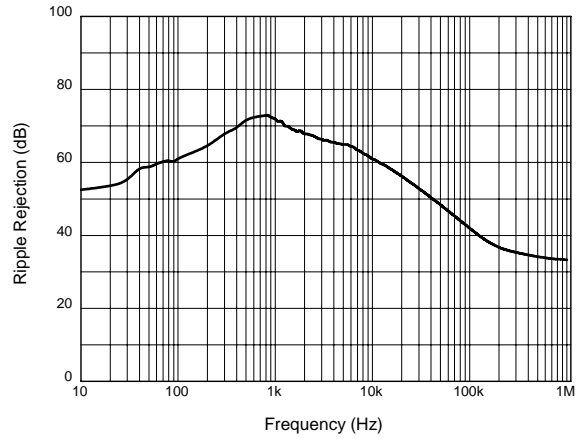

Figure 9. Ripple Rejection vs. Frequency

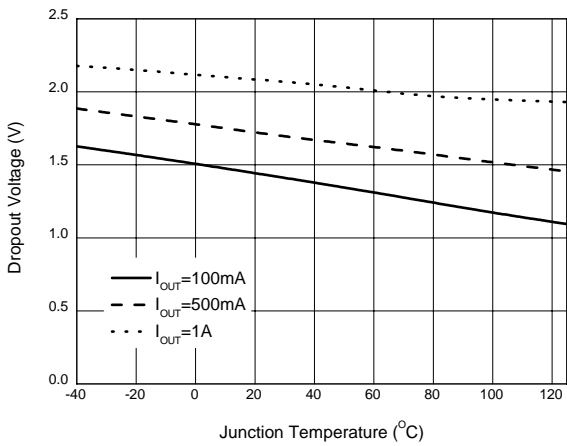

Figure 10. Dropout Voltage vs. Junction Temperature

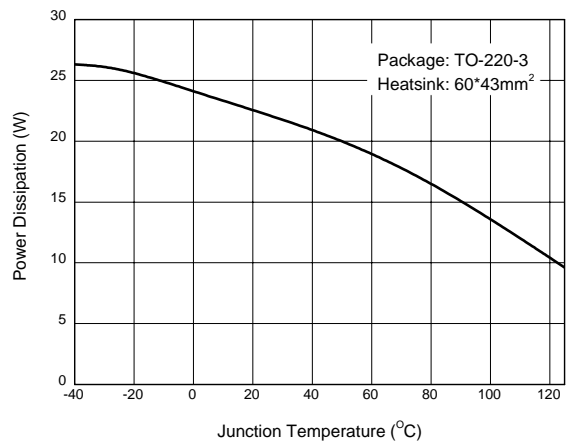

Figure 11. Power Dissipation vs. Junction Temperature



1A 3-TERMINAL POSITIVE VOLTAGE REGULATOR

AS7805A

Typical Performance Characteristics (Continued)

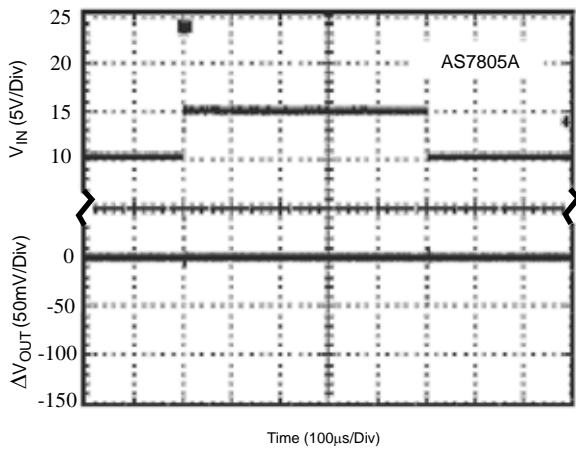

Figure 12. Line Transient
(Conditions: $I_{OUT}=500\text{mA}$, $C_{OUT}=0.1\mu\text{F}$)

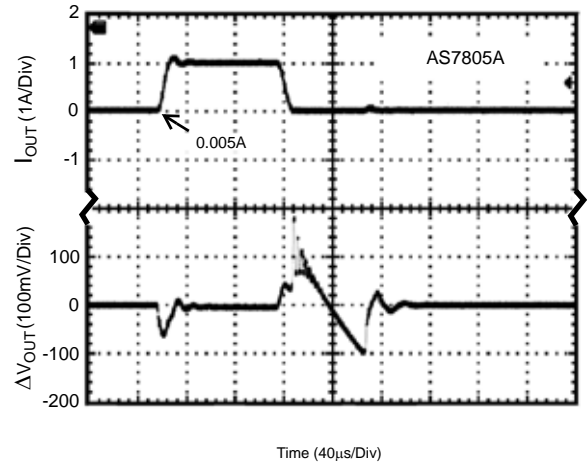

Figure 13. Load Transient
(Conditions: $V_{IN}=10\text{V}$, $C_{IN}=0.33\mu\text{F}$, $C_{OUT}=0.1\mu\text{F}$)



1A 3-TERMINAL POSITIVE VOLTAGE REGULATOR AS7805A

Typical Application

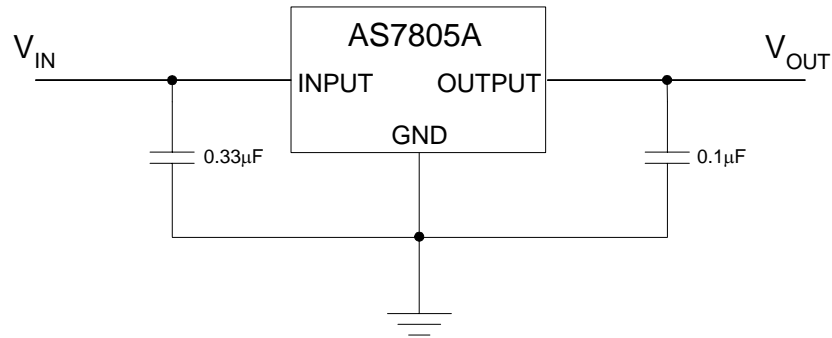

Figure 14. Typical Application of AS7805A



1A 3-TERMINAL POSITIVE VOLTAGE REGULATOR

AS7805A

Mechanical Dimensions

TO-220-3

Unit: mm(inch)

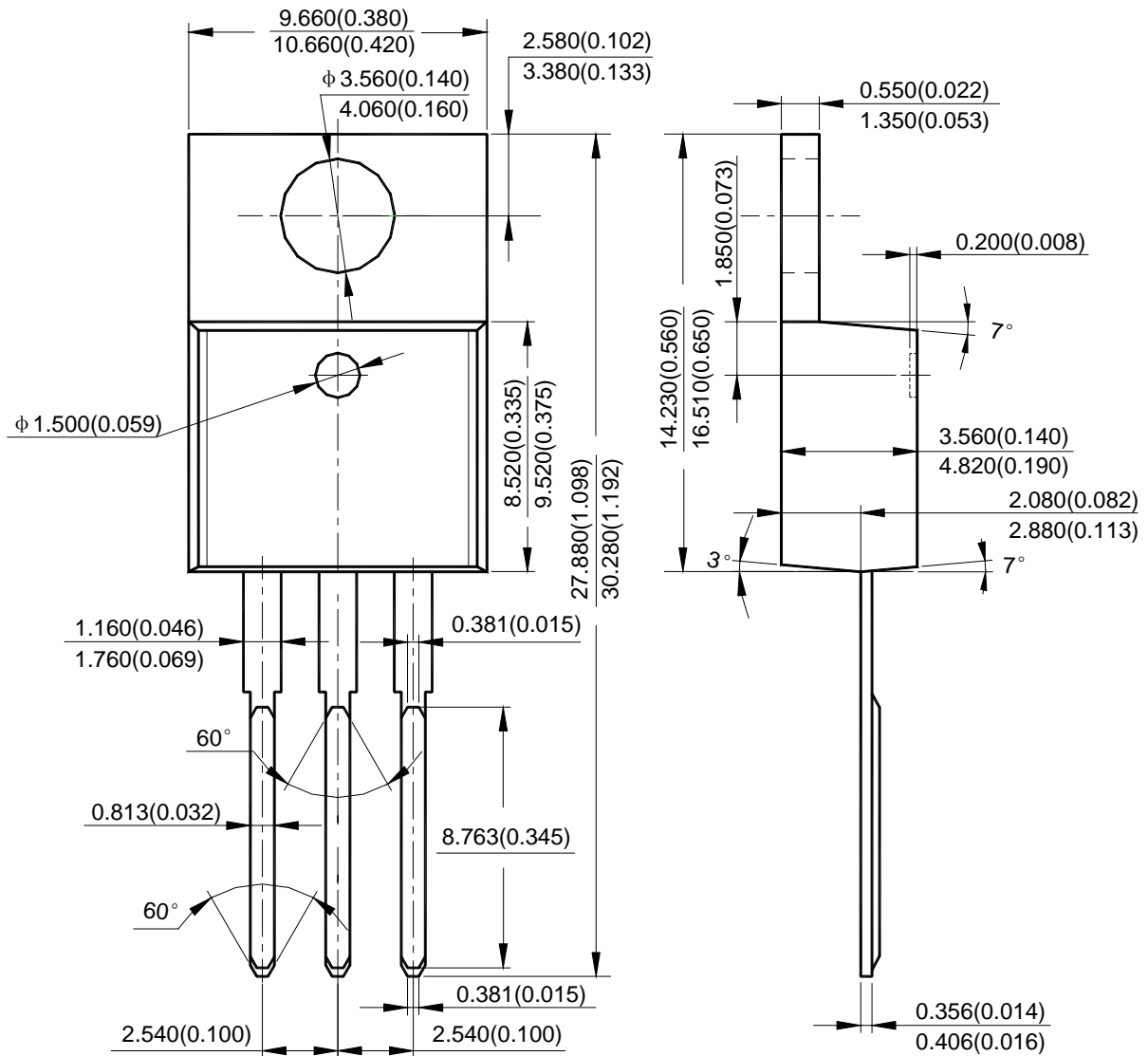



1A 3-TERMINAL POSITIVE VOLTAGE REGULATOR

AS7805A

Mechanical Dimensions (Continued)

TO-252-2(1)

Unit: mm(inch)

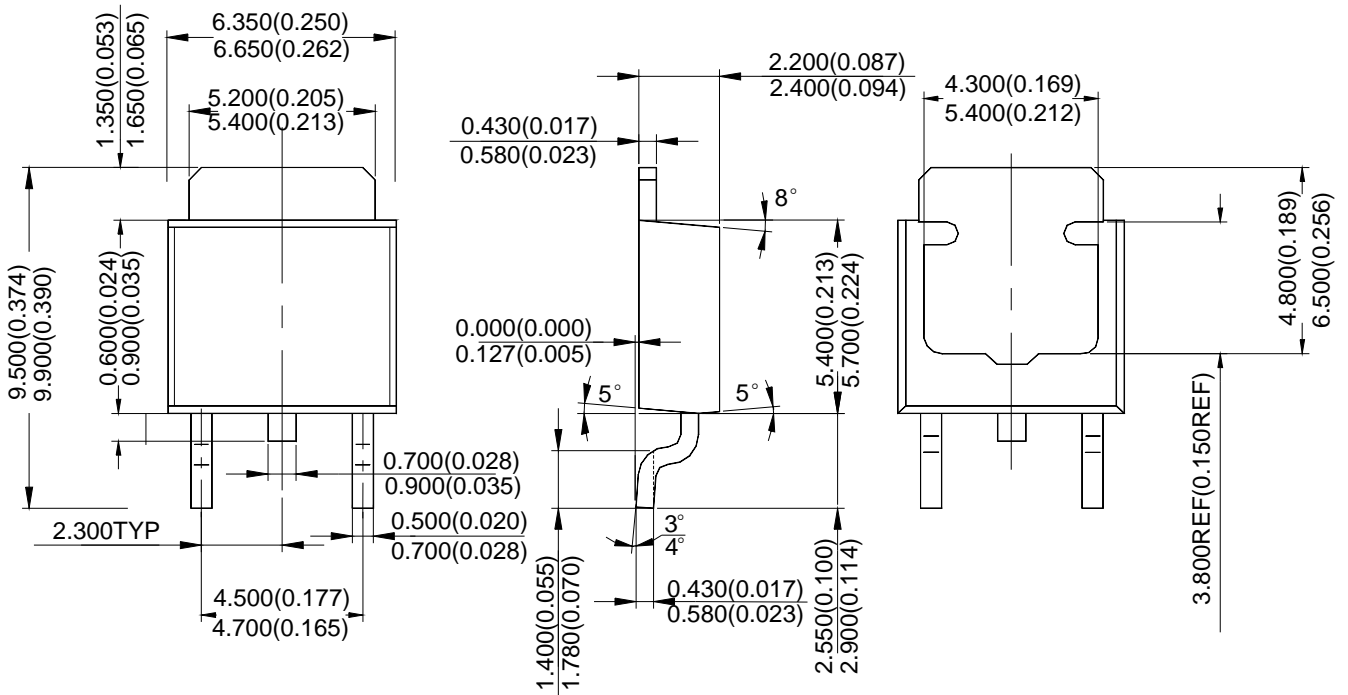



BCD Semiconductor Manufacturing Limited

<http://www.bcdsemi.com>

IMPORTANT NOTICE

BCD Semiconductor Manufacturing Limited reserves the right to make changes without further notice to any products or specifications herein. BCD Semiconductor Manufacturing Limited does not assume any responsibility for use of any its products for any particular purpose, nor does BCD Semiconductor Manufacturing Limited assume any liability arising out of the application or use of any its products or circuits. BCD Semiconductor Manufacturing Limited does not convey any license under its patent rights or other rights nor the rights of others.

MAIN SITE

BCD Semiconductor Manufacturing Limited
- Wafer Fab
Shanghai SIM-BCD Semiconductor Manufacturing Limited
800, Yi Shan Road, Shanghai 200233, China
Tel: +86-21-6485 1491, Fax: +86-21-5450 0008

BCD Semiconductor Manufacturing Limited
- IC Design Group
Advanced Analog Circuits (Shanghai) Corporation
8F, Zone B, 900, Yi Shan Road, Shanghai 200233, China
Tel: +86-21-6495 9539, Fax: +86-21-6485 9673

REGIONAL SALES OFFICE

Shenzhen Office
Shanghai SIM-BCD Semiconductor Manufacturing Co., Ltd. Shenzhen Office
Advanced Analog Circuits (Shanghai) Corporation Shenzhen Office
Room E, 5F, Noble Center, No.1006, 3rd Fuzhong Road, Futian District, Shenzhen 518026, China
Tel: +86-755-8826 7951
Fax: +86-755-8826 7865

Taiwan Office
BCD Semiconductor (Taiwan) Company Limited
4F, 298-1, Rui Guang Road, Nei-Hu District, Taipei,
Taiwan
Tel: +886-2-2656 2808
Fax: +886-2-2656 2806

USA Office
BCD Semiconductor Corporation
30920 Huntwood Ave. Hayward,
CA 94544, U.S.A
Tel : +1-510-324-2988
Fax: +1-510-324-2788

Компания «Океан Электроники» предлагает заключение долгосрочных отношений при поставках импортных электронных компонентов на взаимовыгодных условиях!

Наши преимущества:

- Поставка оригинальных импортных электронных компонентов напрямую с производств Америки, Европы и Азии, а так же с крупнейших складов мира;
- Широкая линейка поставок активных и пассивных импортных электронных компонентов (более 30 млн. наименований);
- Поставка сложных, дефицитных, либо снятых с производства позиций;
- Оперативные сроки поставки под заказ (от 5 рабочих дней);
- Экспресс доставка в любую точку России;
- Помощь Конструкторского Отдела и консультации квалифицированных инженеров;
- Техническая поддержка проекта, помощь в подборе аналогов, поставка прототипов;
- Поставка электронных компонентов под контролем ВП;
- Система менеджмента качества сертифицирована по Международному стандарту ISO 9001;
- При необходимости вся продукция военного и аэрокосмического назначения проходит испытания и сертификацию в лаборатории (по согласованию с заказчиком);
- Поставка специализированных компонентов военного и аэрокосмического уровня качества (Xilinx, Altera, Analog Devices, Intersil, Interpoint, Microsemi, Actel, Aeroflex, Peregrine, VPT, Syfer, Eurofarad, Texas Instruments, MS Kennedy, Miteq, Cobham, E2V, MA-COM, Hittite, Mini-Circuits, General Dynamics и др.);

Компания «Океан Электроники» является официальным дистрибьютором и эксклюзивным представителем в России одного из крупнейших производителей разъемов военного и аэрокосмического назначения «**JONHON**», а так же официальным дистрибьютором и эксклюзивным представителем в России производителя высокотехнологичных и надежных решений для передачи СВЧ сигналов «**FORSTAR**».



JONHON

«**JONHON**» (основан в 1970 г.)

Разъемы специального, военного и аэрокосмического назначения:

(Применяются в военной, авиационной, аэрокосмической, морской, железнодорожной, горно- и нефтедобывающей отраслях промышленности)

«**FORSTAR**» (основан в 1998 г.)

ВЧ соединители, коаксиальные кабели, кабельные сборки и микроволновые компоненты:

(Применяются в телекоммуникациях гражданского и специального назначения, в средствах связи, РЛС, а так же военной, авиационной и аэрокосмической отраслях промышленности).



Телефон: 8 (812) 309-75-97 (многоканальный)

Факс: 8 (812) 320-03-32

Электронная почта: ocean@oceanchips.ru

Web: <http://oceanchips.ru/>

Адрес: 198099, г. Санкт-Петербург, ул. Калинина, д. 2, корп. 4, лит. А