

Small Signal Zener Diodes, Dual

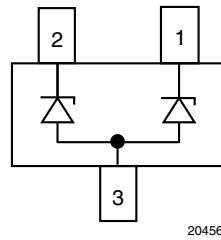
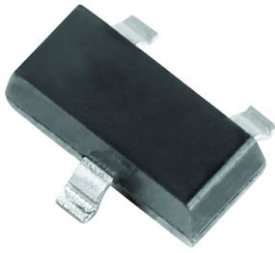

20456

FEATURES

- Dual silicon planar Zener diodes, common anode
- The Zener voltages are graded according to the international E24 standard. Standard Zener voltage tolerance is $\pm 5\%$, indicated by the "C" in the ordering code. Replace "C" with "B" for 2% tolerance.
- The parameters are valid for both diodes in one case. ΔV_Z and ΔR_{zj} of the two diodes in one case is $\leq 5\%$
- AEC-Q101 qualified
- ESD capability according to AEC-Q101:
Human body model > 8 kV
Machine model > 800 V
- Base P/N-G3 - green, commercial grade
- Base P/N-HG3 - green, AEC-Q101 qualified (part number available on request)
- Material categorization: For definitions of compliance please see www.vishay.com/doc?99912

RoHS
 COMPLIANT
 HALOGEN
FREE
GREEN
 (5-2008)

PRIMARY CHARACTERISTICS

PARAMETER	VALUE	UNIT
V_Z range nom.	2.7 to 51	V
Test current I_{ZT}	5	mA
V_Z specification	Pulse current	
Int. construction	Dual common anode	

ORDERING INFORMATION

DEVICE NAME	ORDERING CODE	TAPED UNITS PER REEL	MINIMUM ORDER QUANTITY
AZ23-G-series	AZ23C2V7-G3-08 to AZ23C51-G3-08	3000 (8 mm tape on 7" reel)	15 000
	AZ23B2V7-G3-08 to AZ23B51-G3-08		
	AZ23C2V7-G3-18 to AZ23C51-G3-18	10 000 (8 mm tape on 13" reel)	10 000
	AZ23B2V7-G3-18 to AZ23B51-G3-18		

PACKAGE

PACKAGE NAME	WEIGHT	MOLDING COMPOUND FLAMMABILITY RATING	MOISTURE SENSITIVITY LEVEL	SOLDERING CONDITIONS
SOT-23	8.1 mg	UL 94 V-0	MSL level 1 (according J-STD-020)	260 °C/10 s at terminals

ABSOLUTE MAXIMUM RATINGS ($T_{amb} = 25\text{ °C}$, unless otherwise specified)

PARAMETER	TEST CONDITION	SYMBOL	VALUE	UNIT
Power dissipation	Device on fiberglass substrate, see layout on page 6	P_{tot}	300	mW
Thermal resistance, junction to ambient air	Device on fiberglass substrate, see layout on page 6	R_{thJA}	420	K/W
Junction temperature		T_j	150	°C
Storage temperature range		T_{stg}	-65 to +150	°C
Zener current		I_Z	P_{tot}/V_Z	mA
Operating temperature range		T_{op}	-55 to +150	°C



ELECTRICAL CHARACTERISTICS (T _{amb} = 25 °C, unless otherwise specified)												
PART NUMBER	MARKING CODE	ZENER VOLTAGE RANGE ⁽¹⁾			TEST CURRENT		REVERSE VOLTAGE		DYNAMIC RESISTANCE		TEMPERATURE COEFFICIENT OF ZENER VOLTAGE	
		V _Z at I _{ZT1}			I _{ZT1}	I _{ZT2}	V _R at I _R		Z _Z at I _{ZT1}	Z _{ZK} at I _{ZT2}	α _{VZ} at I _{ZT}	
		V			mA		V	nA	Ω		10 ⁻⁴ /°C	
		MIN.	NOM.	MAX.							MIN.	MAX.
AZ23C2V7-G	D41	2.5	2.7	2.9	5	1	-	-	75 (< 83)	< 500	-9	-4
AZ23C3V0-G	D42	2.8	3.0	3.2	5	1	-	-	80 (< 95)	< 500	-9	-3
AZ23C3V3-G	D43	3.1	3.3	3.5	5	1	-	-	80 (< 95)	< 500	-8	-3
AZ23C3V6-G	D44	3.4	3.6	3.8	5	1	-	-	80 (< 95)	< 500	-8	-3
AZ23C3V9-G	D45	3.7	3.9	4.1	5	1	-	-	80 (< 95)	< 500	-7	-3
AZ23C4V3-G	D46	4	4.3	4.6	5	1	-	-	80 (< 95)	< 500	-6	-1
AZ23C4V7-G	D47	4.4	4.7	5	5	1	-	-	70 (< 78)	< 500	-5	2
AZ23C5V1-G	D48	4.8	5.1	5.4	5	1	> 0.8	100	30 (< 60)	< 480	-3	4
AZ23C5V6-G	D49	5.2	5.6	6	5	1	> 1	100	10 (< 40)	< 400	-2	6
AZ23C6V2-G	D50	5.8	6.2	6.6	5	1	> 2	100	4.8 (< 10)	< 200	-1	7
AZ23C6V8-G	D51	6.4	6.8	7.2	5	1	> 3	100	4.5 (< 8)	< 150	2	7
AZ23C7V5-G	D52	7	7.5	7.9	5	1	> 5	100	4 (< 7)	< 50	3	7
AZ23C8V2-G	D53	7.7	8.2	8.7	5	1	> 6	100	4.5 (< 7)	< 50	4	7
AZ23C9V1-G	D54	8.5	9.1	9.6	5	1	> 7	100	4.8 (< 10)	< 50	5	8
AZ23C10-G	D55	9.4	10	10.6	5	1	> 7.5	100	5.2 (< 15)	< 70	5	8
AZ23C11-G	D56	10.4	11	11.6	5	1	> 8.5	100	6 (< 20)	< 70	5	9
AZ23C12-G	D57	11.4	12	12.7	5	1	> 9	100	7 (< 20)	< 90	6	9
AZ23C13-G	D58	12.4	13	14.1	5	1	> 10	100	9 (< 25)	< 110	7	9
AZ23C15-G	D59	13.8	15	15.6	5	1	> 11	100	11 (< 30)	< 110	7	9
AZ23C16-G	D60	15.3	16	17.1	5	1	> 12	100	13 (< 40)	< 170	8	9.5
AZ23C18-G	D61	16.8	18	19.1	5	1	> 14	100	18 (< 50)	< 170	8	9.5
AZ23C20-G	D62	18.8	20	21.2	5	1	> 15	100	20 (< 50)	< 220	8	10
AZ23C22-G	D63	20.8	22	23.3	5	1	> 17	100	25 (< 55)	< 220	8	10
AZ23C24-G	D64	22.8	24	25.6	5	1	> 18	100	28 (< 80)	< 220	8	10
AZ23C27-G	D65	25.1	27	28.9	5	1	> 20	100	30 (< 80)	< 250	8	10
AZ23C30-G	D66	28	30	32	5	1	> 22.5	100	35 (< 80)	< 250	8	10
AZ23C33-G	D67	31	33	35	5	1	> 25	100	40 (< 80)	< 250	8	10
AZ23C36-G	D68	34	36	38	5	1	> 27	100	40 (< 90)	< 250	8	10
AZ23C39-G	D69	37	39	41	5	1	> 29	100	50 (< 90)	< 300	10	12
AZ23C43-G	D70	40	43	46	5	1	> 32	100	60 (< 100)	< 700	10	12
AZ23C47-G	D71	44	47	50	5	1	> 35	100	70 (< 100)	< 750	10	12
AZ23C51-G	D72	48	51	50	5	1	> 38	100	70 (< 100)	< 750	10	12

Note

⁽¹⁾ Tested with pulses t_p = 5 ms



ELECTRICAL CHARACTERISTICS ($T_{amb} = 25\text{ }^{\circ}\text{C}$, unless otherwise specified)												
PART NUMBER	MARKING CODE	ZENER VOLTAGE RANGE ⁽¹⁾			TEST CURRENT		REVERSE VOLTAGE		DYNAMIC RESISTANCE		TEMPERATURE COEFFICIENT OF ZENER VOLTAGE	
		V_Z at I_{ZT1}			I_{ZT1}	I_{ZT2}	V_R at I_R		Z_Z at I_{ZT1}	Z_{ZK} at I_{ZT2}	α_{VZ} at I_{ZT}	
		V			mA		V	nA	Ω		$10^{-4}/^{\circ}\text{C}$	
		MIN.	NOM.	MAX.							MIN.	MAX.
AZ23B2V7-G	D41	2.65	2.7	2.75	5	1	-	-	75 (< 83)	< 500	-9	-4
AZ23B3V0-G	D42	2.94	3.0	3.06	5	1	-	-	80 (< 95)	< 500	-9	-3
AZ23B3V3-G	D43	3.23	3.3	3.37	5	1	-	-	80 (< 95)	< 500	-8	-3
AZ23B3V6-G	D44	3.53	3.6	3.67	5	1	-	-	80 (< 95)	< 500	-8	-3
AZ23B3V9-G	D45	3.82	3.9	3.98	5	1	-	-	80 (< 95)	< 500	-7	-3
AZ23B4V3-G	D46	4.21	4.3	4.39	5	1	-	-	80 (< 95)	< 500	-6	-1
AZ23B4V7-G	D47	4.61	4.7	4.79	5	1	-	-	70 (< 78)	< 500	-5	2
AZ23B5V1-G	D48	5	5.1	5.2	5	1	> 0.8	100	30 (< 60)	< 480	-3	4
AZ23B5V6-G	D49	5.49	5.6	5.71	5	1	> 1	100	10 (< 40)	< 400	-2	6
AZ23B6V2-G	D50	6.08	6.2	6.32	5	1	> 2	100	4.8 (< 10)	< 200	-1	7
AZ23B6V8-G	D51	6.66	6.8	6.94	5	1	> 3	100	4.5 (< 8)	< 150	2	7
AZ23B7V5-G	D52	7.35	7.5	7.65	5	1	> 5	100	4 (< 7)	< 50	3	7
AZ23B8V2-G	D53	8.04	8.2	8.36	5	1	> 6	100	4.5 (< 7)	< 50	4	7
AZ23B9V1-G	D54	8.92	9.1	9.28	5	1	> 7	100	4.8 (< 10)	< 50	5	8
AZ23B10-G	D55	9.8	10	10.2	5	1	> 7.5	100	5.2 (< 15)	< 70	5	8
AZ23B11-G	D56	10.8	11	11.2	5	1	> 8.5	100	6 (< 20)	< 70	5	9
AZ23B12-G	D57	11.8	12	12.2	5	1	> 9	100	7 (< 20)	< 90	6	9
AZ23B13-G	D58	12.7	13	13.3	5	1	> 10	100	9 (< 25)	< 110	7	9
AZ23B15-G	D59	14.7	15	15.3	5	1	> 11	100	11 (< 30)	< 110	7	9
AZ23B16-G	D60	15.7	16	16.3	5	1	> 12	100	13 (< 40)	< 170	8	0.5
AZ23B18-G	D61	17.6	18	18.4	5	1	> 14	100	18 (< 50)	< 170	8	0.5
AZ23B20-G	D62	19.6	20	20.4	5	1	> 15	100	20 (< 50)	< 220	8	10
AZ23B22-G	D63	21.6	22	22.4	5	1	> 17	100	25 (< 55)	< 220	8	10
AZ23B24-G	D64	23.5	24	24.5	5	1	> 18	100	28 (< 80)	< 220	8	10
AZ23B27-G	D65	26.5	27	27.5	5	1	> 20	100	30 (< 80)	< 250	8	10
AZ23B30-G	D66	29.4	30	30.6	5	1	> 22.5	100	35 (< 80)	< 250	8	10
AZ23B33-G	D67	32.3	33	33.7	5	1	> 25	100	40 (< 80)	< 250	8	10
AZ23B36-G	D68	35.3	36	36.7	5	1	> 27	100	40 (< 90)	< 250	8	10
AZ23B39-G	D69	38.2	39	39.8	5	1	> 29	100	50 (< 90)	< 300	10	12
AZ23B43-G	D70	42.1	43	43.9	5	1	> 32	100	60 (< 100)	< 700	10	12
AZ23B47-G	D71	46.1	47	47.9	5	1	> 35	100	70 (< 100)	< 750	10	12
AZ23B51-G	D72	50	51	52	5	1	> 38	100	70 (< 100)	< 750	10	12

Note

⁽¹⁾ Tested with pulses $t_p = 5\text{ ms}$

TYPICAL CHARACTERISTICS ($T_{amb} = 25\text{ }^{\circ}\text{C}$, unless otherwise specified)

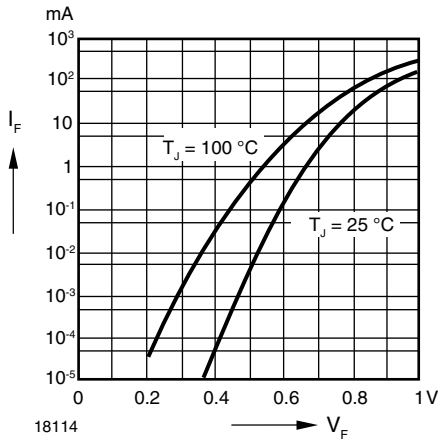

Fig. 1 - Forward Characteristics

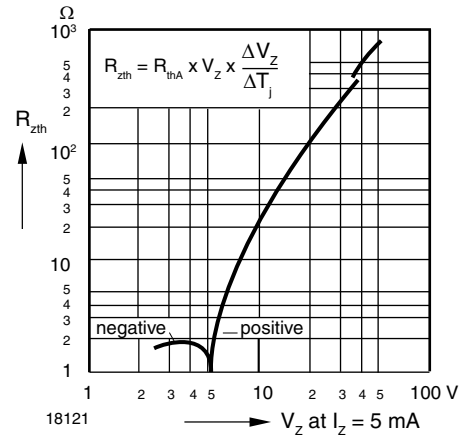

Fig. 4 - Thermal Differential Resistance vs. Zener Voltage

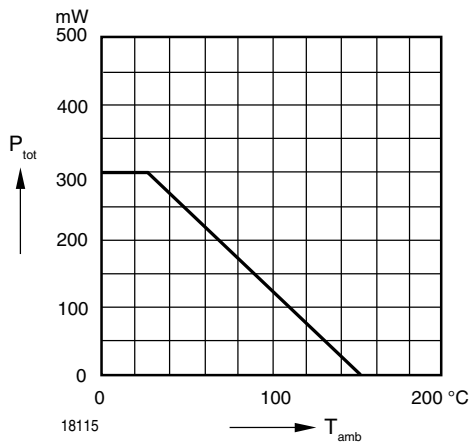

Fig. 2 - Admissible Power Dissipation vs. Ambient Temperature

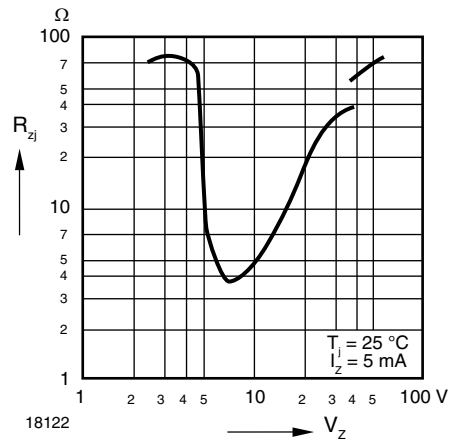

Fig. 5 - Dynamic Resistance vs. Zener Voltage

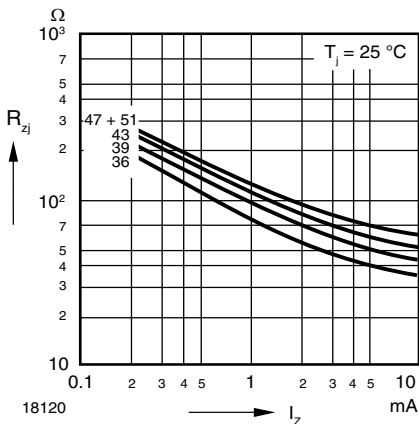

Fig. 3 - Dynamic Resistance vs. Zener Current

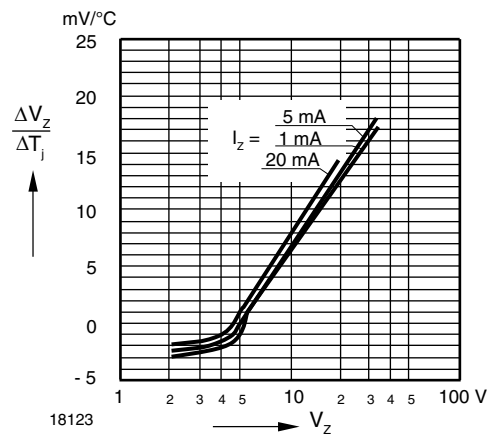

Fig. 6 - Temperature Dependence of Zener Voltage vs. Zener Voltage

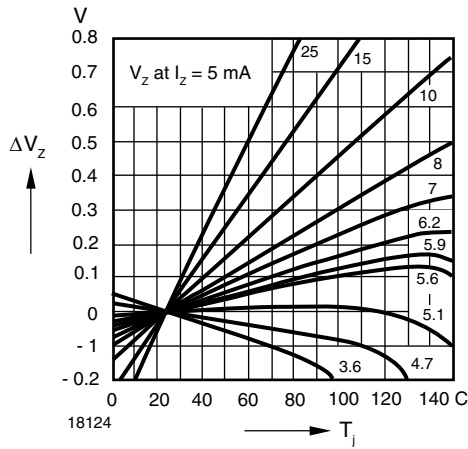

Fig. 7 - Change of Zener Voltage vs. Junction Temperature

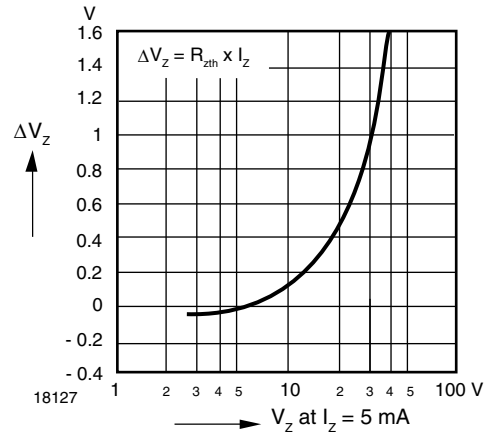

Fig. 10 - Change of Zener Voltage from Turn-on up to the Point of Thermal Equilibrium vs. Zener Voltage

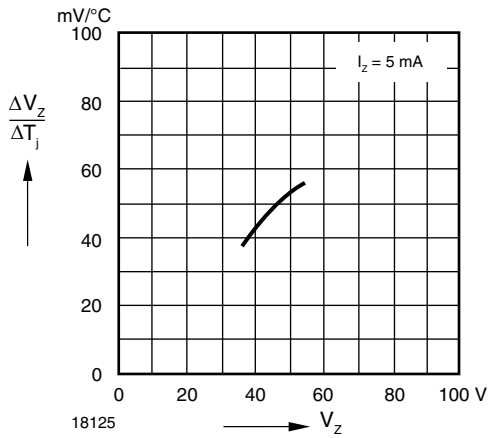

Fig. 8 - Temperature Dependence of Zener Voltage vs. Zener Voltage

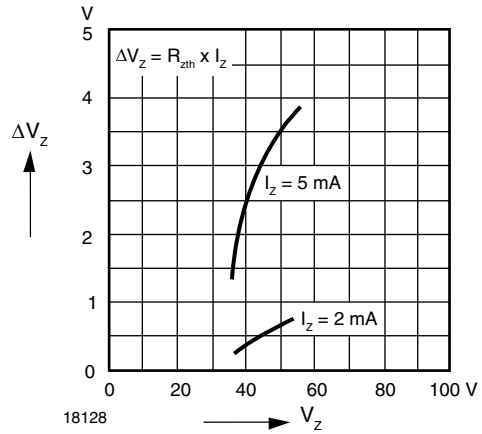

Fig. 11 - Change of Zener Voltage from Turn-on up to the Point of Thermal Equilibrium vs. Zener Voltage

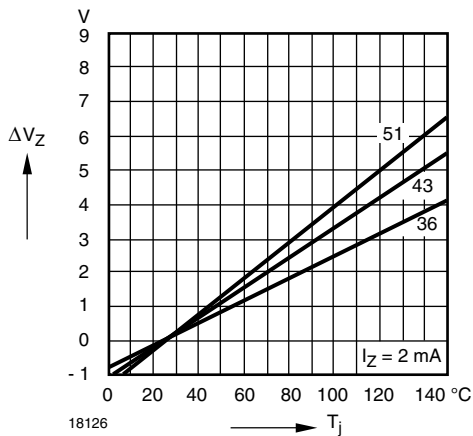

Fig. 9 - Change of Zener Voltage vs. Junction Temperature

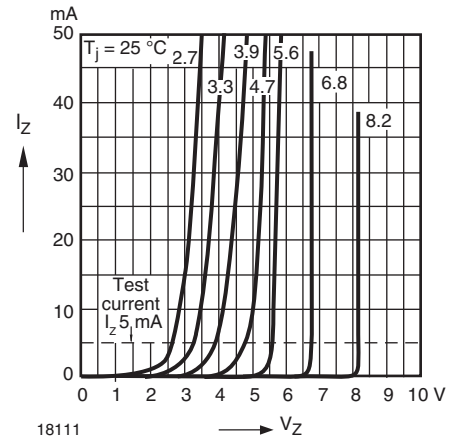

Fig. 12 - Breakdown Characteristics



Fig. 13 - Breakdown Characteristics

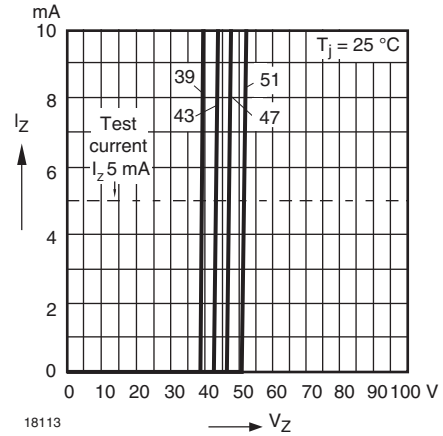
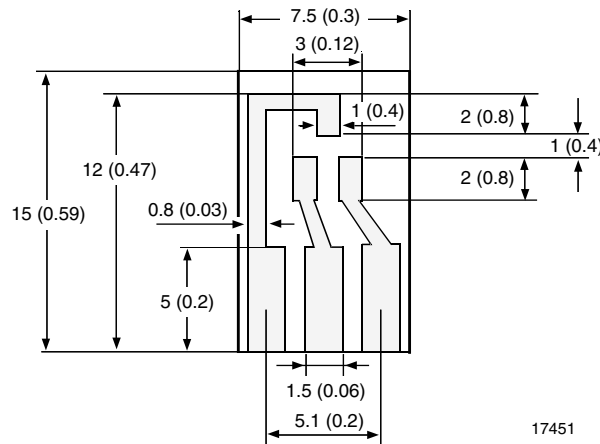

Fig. 14 - Breakdown Characteristics

LAYOUT FOR R_{thJA} TEST

Thickness: fiberglass 0.059" (1.5 mm)

Copper leads 0.012" (0.3 mm)





PACKAGE DIMENSIONS in millimeters (inches): SOT-23

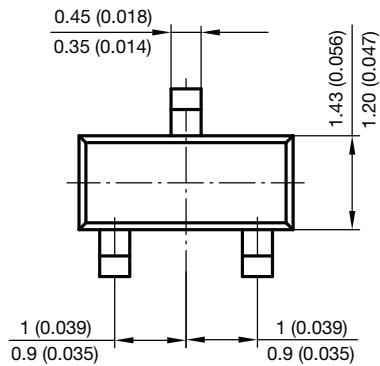
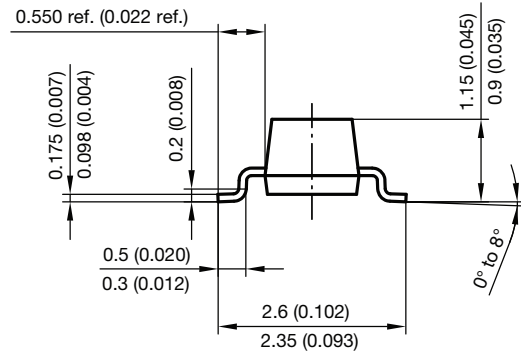
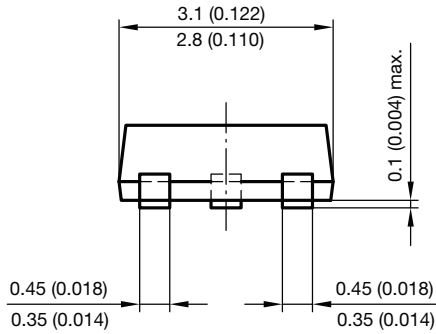

Foot print recommendation:

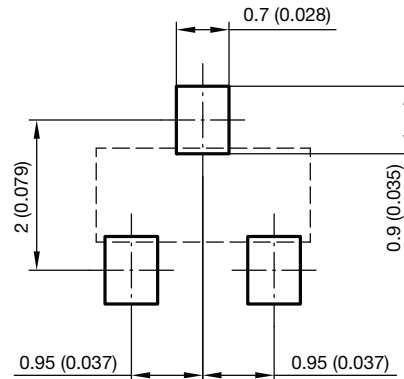

Document no.: 6.541-5014.01-4
 Rev. 8 - Date: 23.Sept.2009
 17418



Disclaimer

ALL PRODUCT, PRODUCT SPECIFICATIONS AND DATA ARE SUBJECT TO CHANGE WITHOUT NOTICE TO IMPROVE RELIABILITY, FUNCTION OR DESIGN OR OTHERWISE.

Vishay Intertechnology, Inc., its affiliates, agents, and employees, and all persons acting on its or their behalf (collectively, "Vishay"), disclaim any and all liability for any errors, inaccuracies or incompleteness contained in any datasheet or in any other disclosure relating to any product.

Vishay makes no warranty, representation or guarantee regarding the suitability of the products for any particular purpose or the continuing production of any product. To the maximum extent permitted by applicable law, Vishay disclaims (i) any and all liability arising out of the application or use of any product, (ii) any and all liability, including without limitation special, consequential or incidental damages, and (iii) any and all implied warranties, including warranties of fitness for particular purpose, non-infringement and merchantability.

Statements regarding the suitability of products for certain types of applications are based on Vishay's knowledge of typical requirements that are often placed on Vishay products in generic applications. Such statements are not binding statements about the suitability of products for a particular application. It is the customer's responsibility to validate that a particular product with the properties described in the product specification is suitable for use in a particular application. Parameters provided in datasheets and/or specifications may vary in different applications and performance may vary over time. All operating parameters, including typical parameters, must be validated for each customer application by the customer's technical experts. Product specifications do not expand or otherwise modify Vishay's terms and conditions of purchase, including but not limited to the warranty expressed therein.

Except as expressly indicated in writing, Vishay products are not designed for use in medical, life-saving, or life-sustaining applications or for any other application in which the failure of the Vishay product could result in personal injury or death. Customers using or selling Vishay products not expressly indicated for use in such applications do so at their own risk. Please contact authorized Vishay personnel to obtain written terms and conditions regarding products designed for such applications.

No license, express or implied, by estoppel or otherwise, to any intellectual property rights is granted by this document or by any conduct of Vishay. Product names and markings noted herein may be trademarks of their respective owners.

Material Category Policy

Vishay Intertechnology, Inc. hereby certifies that all its products that are identified as RoHS-Compliant fulfill the definitions and restrictions defined under Directive 2011/65/EU of The European Parliament and of the Council of June 8, 2011 on the restriction of the use of certain hazardous substances in electrical and electronic equipment (EEE) - recast, unless otherwise specified as non-compliant.

Please note that some Vishay documentation may still make reference to RoHS Directive 2002/95/EC. We confirm that all the products identified as being compliant to Directive 2002/95/EC conform to Directive 2011/65/EU.

Vishay Intertechnology, Inc. hereby certifies that all its products that are identified as Halogen-Free follow Halogen-Free requirements as per JEDEC JS709A standards. Please note that some Vishay documentation may still make reference to the IEC 61249-2-21 definition. We confirm that all the products identified as being compliant to IEC 61249-2-21 conform to JEDEC JS709A standards.

Компания «Океан Электроники» предлагает заключение долгосрочных отношений при поставках импортных электронных компонентов на взаимовыгодных условиях!

Наши преимущества:

- Поставка оригинальных импортных электронных компонентов напрямую с производств Америки, Европы и Азии, а так же с крупнейших складов мира;
- Широкая линейка поставок активных и пассивных импортных электронных компонентов (более 30 млн. наименований);
- Поставка сложных, дефицитных, либо снятых с производства позиций;
- Оперативные сроки поставки под заказ (от 5 рабочих дней);
- Экспресс доставка в любую точку России;
- Помощь Конструкторского Отдела и консультации квалифицированных инженеров;
- Техническая поддержка проекта, помощь в подборе аналогов, поставка прототипов;
- Поставка электронных компонентов под контролем ВП;
- Система менеджмента качества сертифицирована по Международному стандарту ISO 9001;
- При необходимости вся продукция военного и аэрокосмического назначения проходит испытания и сертификацию в лаборатории (по согласованию с заказчиком);
- Поставка специализированных компонентов военного и аэрокосмического уровня качества (Xilinx, Altera, Analog Devices, Intersil, Interpoint, Microsemi, Actel, Aeroflex, Peregrine, VPT, Syfer, Eurofarad, Texas Instruments, MS Kennedy, Miteq, Cobham, E2V, MA-COM, Hittite, Mini-Circuits, General Dynamics и др.);

Компания «Океан Электроники» является официальным дистрибьютором и эксклюзивным представителем в России одного из крупнейших производителей разъемов военного и аэрокосмического назначения «JONHON», а так же официальным дистрибьютором и эксклюзивным представителем в России производителя высокотехнологичных и надежных решений для передачи СВЧ сигналов «FORSTAR».



JONHON

«JONHON» (основан в 1970 г.)

Разъемы специального, военного и аэрокосмического назначения:

(Применяются в военной, авиационной, аэрокосмической, морской, железнодорожной, горно- и нефтедобывающей отраслях промышленности)

«FORSTAR» (основан в 1998 г.)

ВЧ соединители, коаксиальные кабели, кабельные сборки и микроволновые компоненты:

(Применяются в телекоммуникациях гражданского и специального назначения, в средствах связи, РЛС, а так же военной, авиационной и аэрокосмической отраслях промышленности).



Телефон: 8 (812) 309-75-97 (многоканальный)

Факс: 8 (812) 320-03-32

Электронная почта: ocean@oceanchips.ru

Web: <http://oceanchips.ru/>

Адрес: 198099, г. Санкт-Петербург, ул. Калинина, д. 2, корп. 4, лит. А