

# L Series Miniature Slide Switches

## Features/Benefits

- Positive detent
- Enclosed housing
- Maintained and momentary functions
- PC and panel mounting
- RoHS compliant

## Typical Applications

- Communications equipment
- Lighting devices

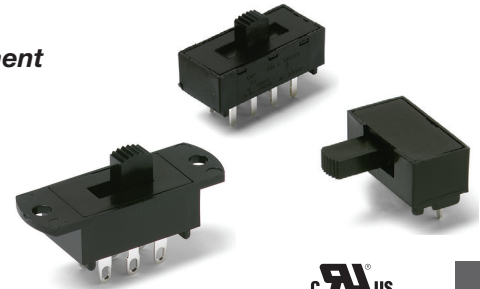

Models Available



Slide

## Specifications

**CONTACT RATING:** Q contact material (LX0X, LX1X Models): 4 AMPS @ 125 V AC or 28 V DC; 2 AMPS @ 250 V AC; 0.5 AMP @ 125 V DC (UL). See page I-23 for additional ratings.

**ELECTRICAL LIFE:** 10,000 make-and-break cycles at full load.

**CONTACT RESISTANCE:** Below 10 m Ω typ. initial @ 2-4 V DC, 100 mA, for both silver and gold plated contacts.

**INSULATION RESISTANCE:** 10<sup>9</sup> Ω min.

**DIELECTRIC STRENGTH:** 1,000 Vrms min. @ sea level.

**OPERATING TEMPERATURE:** -30°C to +65°C

**STORAGE TEMPERATURE:** -30°C to +85°C

**NOTE:** Specifications and materials listed above are for switches with standard options. For information on specific and custom switches, consult Customer Service Center.

## Materials

**HOUSING:** 6/6 nylon (UL94V-2), black.

**ACTUATOR:** 6/6 nylon (UL94V-2), black. '13' actuator, natural (standard).

**CONTACTS:** Q contact material: Copper, silver plated. See page I-23 for additional contact materials.

**TERMINALS:** Q contact material: Copper, silver plated. See page I-23 for additional contact materials.

**CONTACT SPRING:** Music wire or stainless steel.

**TERMINAL SEAL:** Epoxy.

**NOTE:** Any models supplied with Q, B or G contact material are RoHS compliant.

## Build-A-Switch

To order, simply select desired option from each category and place in the appropriate box. Available options are shown and described on pages I-20 through I-24. For additional options not shown in catalog, consult Customer Service Center.



### Switch Function

- L202** DPDT
- L203** DP3T
- L101** SPST
- L102** SPDT
- L103** SP3T
- L104** SP4T
- L112** SPDT, mom.
- L113** SP3T, mom. to one end
- L123** SP3T, mom. to both ends
- L201** DPST
- L204** DP4T
- L212** DPDT, mom.

### Actuator

- 01** .200" high
- 02** .335" high
- 03** .375" high
- 05** .312" high
- 11** .100" high
- 12** Screwdriver slot
- 13** Plunger without cap
- 14** Plunger with .200" dia. cap
- 15** Plunger with .310" dia. cap
- 17** Plunger with .458" dia. cap
- 19** Plunger with .590" dia. cap

### Detent

- 1** With detent
- 2** Without detent

### Mounting Style

- MS** PC Thru-hole
- MA** Right angle, PC thru-hole
- ML** Right angle, PC thru-hole
- MV** Right angle, PC thru-hole
- SS** Panel with mounting ears
- TS** Panel with integral mounting ears

### Terminations

- 02** PC Thru-hole
- 01** Solder lug with notch
- 03** Solder lug with hole
- 04** PC Thru-hole
- 10** PC Thru-hole
- 06** Wire wrap
- 12** PC Thru-hole

### Contact Material

- B** Gold
- Q** Silver
- G** Gold over silver

### Seal

- NONE** No seal
- E** Epoxy seal

### Cap Color

- 2** Black
- NONE** No cap



# L Series Miniature Slide Switches

## SWITCH AND LOCK FUNCTION



NO. POLES	MODEL NO.	SWITCH FUNCTION	SCHEMATIC	AVAILABLE MOUNTING STYLES
SP	<b>L101</b>	SPST		ML, MS, SS
	<b>L102</b>	SPDT		ML, MS, SS
	<b>L112</b>	SPDT-MOM.		ML, MS, MV, SS
	<b>L103</b>	SP3T		MA, MS, TS
	<b>L113</b>	SP3T-MOM. to one end		MA, MS, TS
	<b>L123</b>	SP3T-MOM. to both ends		MA, MS, TS
	<b>L104</b>	SP4T		MS

NO. POLES	MODEL NO.	SWITCH FUNCTION	SCHEMATIC	AVAILABLE MOUNTING STYLES
DP	<b>L201</b>	DPST		MA, MS, SS
	<b>L202</b>	DPDT		MA, MS, SS
	<b>L212</b>	DPDT-MOM.		MV
	<b>L203</b>	DP3T		MS, TS
	<b>L204</b>	DP4T		MS

NOTE: and MOM. in table indicates momentary action.

All models with all options when ordered with 'G' or 'Q' contact material.

Contacts make on side actuator thrown.

## ACTUATOR



### ACTUATOR OPTIONS FOR 'MS, MA, ML, SS, & TS' MOUNTING STYLES

**01** .200" HIGH

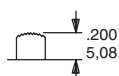

**02** .335" HIGH

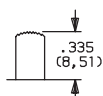

**03** .375" HIGH

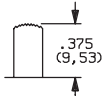

**05** .312" HIGH

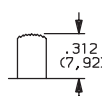

**11** .100" HIGH



**12** SCREWDRIVER SLOT

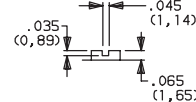

NOTE: No actuator color option code is required. Standard actuator color is black, other colors and heights available, consult Customer Service Center. See pages I-20 and I-22 for available mounting styles.

### ACTUATOR OPTIONS FOR 'MV' MOUNTING STYLE

**13** PLUNGER WITHOUT CAP

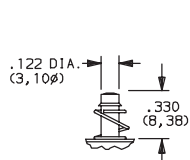

**14** PLUNGER WITH CAP

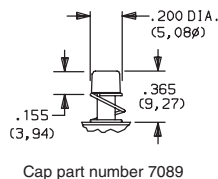

**15** PLUNGER WITH CAP

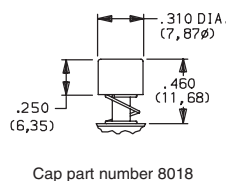

**17** PLUNGER WITH CAP

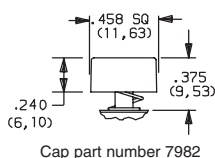

**19** PLUNGER WITH CAP

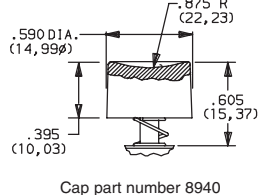

OPTION CODE	ACTUATOR CAP COLORS
<b>2</b>	BLACK
<b>NONE</b>	01-13 ACTUATORS

Other colors available, consult Customer Service Center.

### ACTUATOR CAPS

Caps supplied are not installed standard. To order actuator options '14 thru 19,' select desired cap color from chart and place option code in last box of ordering format. Leave box empty for all other actuator options. Caps may also be ordered separately and user installed, see pages I-23 and I-24. Specify the four digit part number and desired cap color. For switches without caps, order '13' or '23' actuator option. Cap finish: gloss (excluding square cap part number 7982, finish: matte).



Dimensions are shown: Inch (mm)  
Specifications and dimensions subject to change

Slide

# L Series Miniature Slide Switches

## DETENT

### 1 WITH DETENT

Standard with all maintained models: L101, L102, L103, L104, L113, L201, L202, L203 and L204.

### 2 WITHOUT DETENT

Standard with all momentary models: L112, L123, and L212.

## MOUNTING STYLE

### MS PC THRU-HOLE, 2 POSITION MODELS



#### AVAILABLE WITH:

**Models:** L101, L102, L112, L103, L113 L123, L201, L202, L203, L104 and L204  
**Terminations:** 02, 06, 10 and 12  
**Actuators:** 01, 02, 03, 05, 11 and 12

#### PC MOUNTING

For mounting information, see TERMINATIONS section, page I-23.



L203011MS02Q

**DP3T**

### PC THRU-HOLE, 3 POSITION MODELS

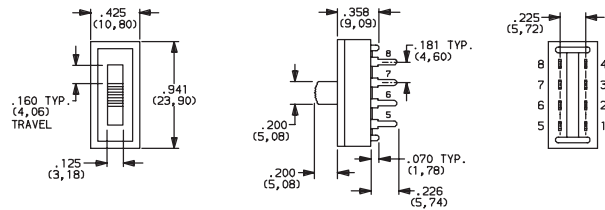

### PC THRU HOLE, 4 POSITION MODELS

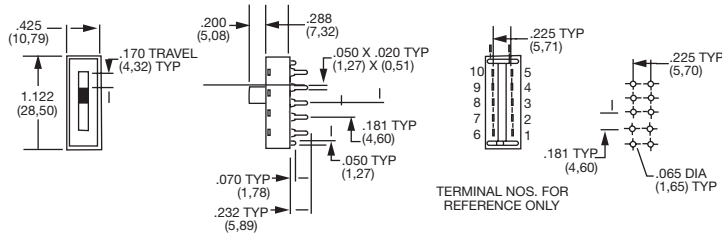

### MA RIGHT ANGLE, PC THRU-HOLE

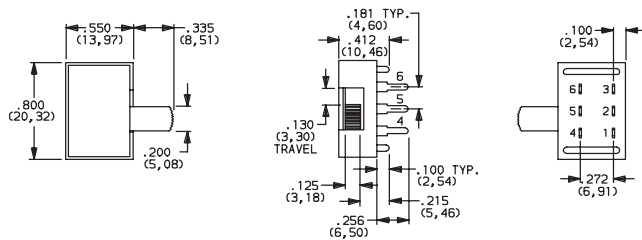

#### AVAILABLE WITH:

**Models:** L103, L201, L202, L113 and L123  
**Terminations:** 04  
**Actuators:** 02 and 12

#### PC MOUNTING

For mounting information, see TERMINATIONS section, page I-23.

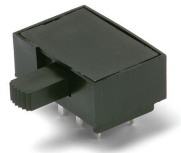

L202021MA04Q  
Horizontal Actuation

**DPDT**

### RIGHT ANGLE, PC, SP-3 POSITION MODELS

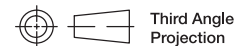
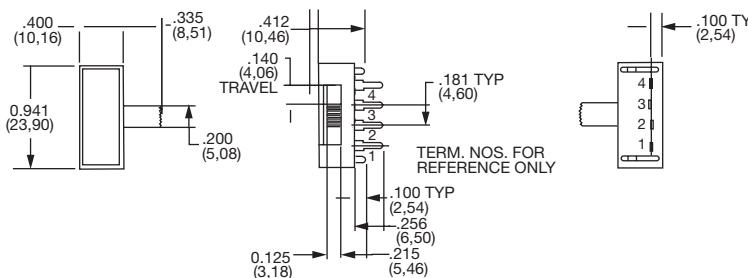

Third Angle Projection  
 Dimensions are shown: Inches (mm)  
 Specifications and dimensions subject to change

# L Series Miniature Slide Switches

## MOUNTING STYLE



### ML RIGHT ANGLE, PC THRU-HOLE

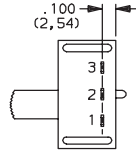
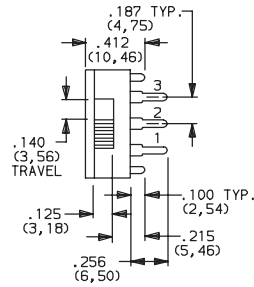
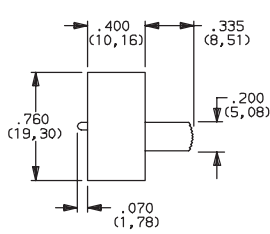

#### AVAILABLE WITH:

**Models:** L101, L102, L112  
**Terminations:** 04  
**Actuators:** 01, 02, 05, 11 and 12  
**PC MOUNTING**

For mounting information, see TERMINATIONS section, page I-23.



**L10201ML04Q**  
Horizontal Actuation  
**SPDT**

### MV RIGHT ANGLE, PC THRU-HOLE

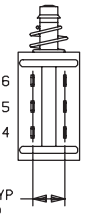
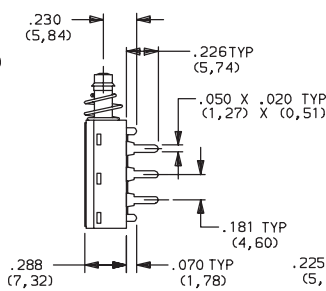
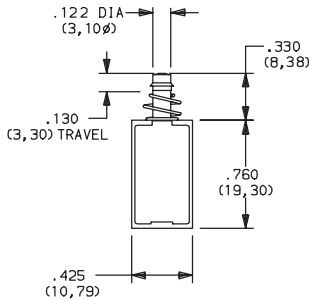

#### AVAILABLE WITH:

**Models:** L112 and L212  
**Terminations:** 02, 06, 10 and 12  
**Actuators:** 13 thru 19

#### PC MOUNTING

For mounting information, see TERMINATIONS section, page I-23.

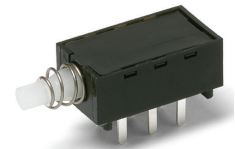

**L212132MV02Q**  
**DPDT**

### SS PANEL WITH MOUNTING EARS



**L202011SS03Q**  
**DPDT**

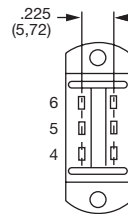
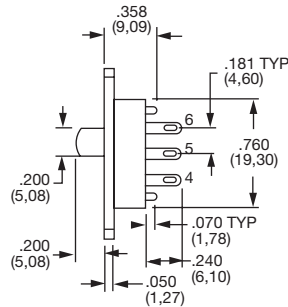
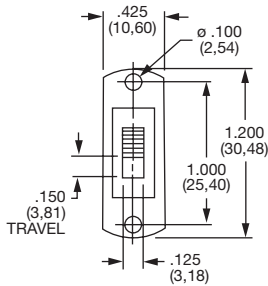

#### PANEL MOUNTING

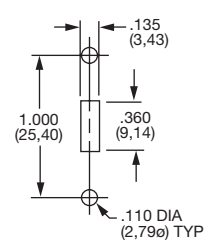

#### AVAILABLE WITH:

**Models:** L101, L102, L112, L201 and L202  
**Terminations:** 01, 02, 03, 06, 10, 12  
**Actuators:** 01, 02, 03, 05, 11 and 12

### TS PANEL WITH INTEGRAL MOUNTING EARS



**L203011TS03Q**  
**DP3T**

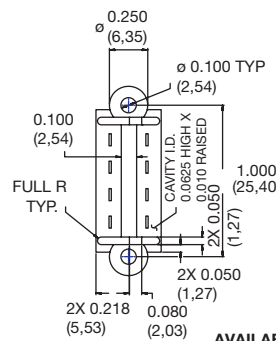
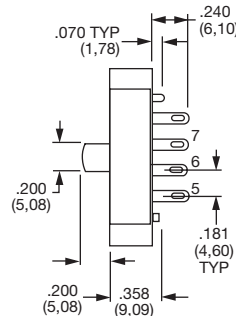
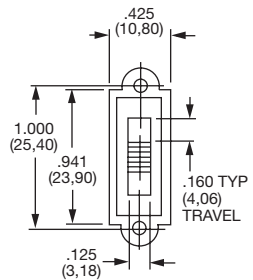

#### PANEL MOUNTING

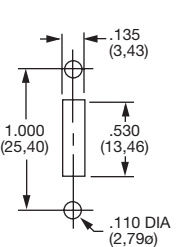

#### AVAILABLE WITH:

**Models:** L103, L113, L123 and L203  
**Terminations:** 01, 02, 03, 06, 10, 12  
**Actuators:** 01, 02, 03, 05, 11 and 12



Third Angle  
Projection

Dimensions are shown: Inch (mm)  
Specifications and dimensions subject to change

# L Series Miniature Slide Switches

## TERMINATIONS

'MS, MV, SS & TS' Mounting Styles Only

**02** PC THRU-HOLE

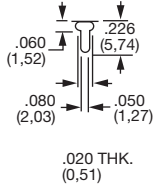

**01** SOLDER LUG WITH NOTCH

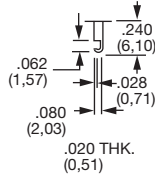

**03** SOLDER LUG WITH HOLE

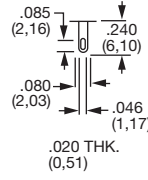

**10** PC THRU-HOLE

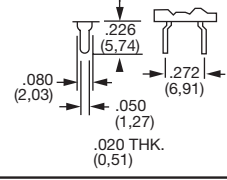

**12** PC THRU-HOLE

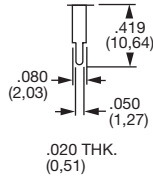

**06** WIRE WRAP

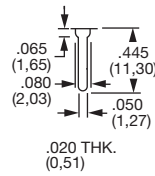

'MA & ML' Mounting Styles Only

**04** PC THRU-HOLE

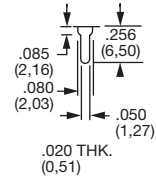

All models with '04' terminations and 'ML' mounting style.

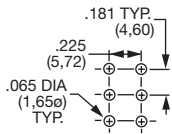

All 2 position models, except '04' and '10' terminations.

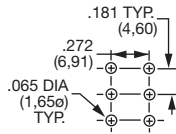

All 2 position models with '04' and '10' terminations.

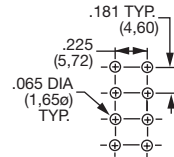

All 3 position models except '04' and '10' terminations.

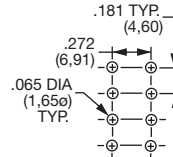

All 3 position models, with '10' termination.

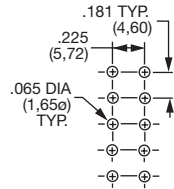

All 4 position models, except '04' and '10' terminations.



All 4 position models, with '10' terminations.

## CONTACT MATERIAL

OPTION CODE	CONTACT MATERIAL	RATINGS	
<b>B</b>	GOLD <sup>1</sup>	LOW LEVEL/DRY CIRCUIT	0.4 VA MAX. @20 V AC OR DC max.
<b>Q</b>	SILVER <sup>2</sup>	POWER	LX0X, LX1X MODELS: 4 AMPS @ 125 V AC or 28 V DC; 2 AMPS @ 250 V AC; 0.5 AMP @ 125 V DC (UL). LX6X MODELS: 4 AMPS @ 125 V AC or 28 V DC; 2 AMPS @ 250 V AC (UL).
<b>G</b>	GOLD OVER SILVER <sup>3</sup>	LOW LEVEL/DRY CIRCUIT OR POWER	LX0X, LX1X MODELS: 0.4 VA MAX. @ 20 V AC or DC MAX. or 4 AMPS @ 125 V AC or 28 V DC; 2 AMPS @ 250 V AC; 0.5 AMP @ 125 V DC (UL). LX6X MODELS: 0.4 VA MAX. @ 20 V AC or DC MAX. or 4 AMPS @ 125 V AC or 28 V DC; 2 AMPS @ 250 V AC (UL).

\* Note: See Technical Data section of this catalog for RoHS compliant and compatible definitions and specifications.

<sup>1</sup> CONTACTS & TERMINALS: Copper, with gold plate over nickel plate.

<sup>2</sup> CONTACTS & TERMINALS: Copper, silver plated (standard with all termination options).

<sup>3</sup> CONTACTS & TERMINALS: Copper, with gold plate over nickel plate over silver plate.

**NOTE:** Any models supplied with B, Q or G contact material are RoHS compliant.

All models  with all options when ordered with 'G' or 'Q' contact material.

NOTE: 'G' contact material is equivalent to both 'B' and 'Q' contact materials.

## SEAL

**NONE** NO SEAL

**E** EPOXY SEAL

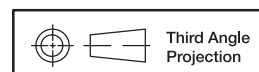
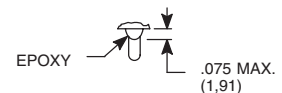

Dimensions are shown: Inches (mm)  
Specifications and dimensions subject to change

**C&K**

19 Mar 2019

Slide

# L Series Miniature Slide Switches

## AVAILABLE HARDWARE

Cap  
Compatible with 13-19 actuators



**PART NO.**  
**708902000** BLACK  
**708903000** RED

Material: Nylon  
Finish: Gloss

Cap  
Compatible with 13-19 actuators



**PART NO.**  
**752702000** BLACK  
**752703000** RED

Material: Nylon  
Finish: Gloss

Cap  
Compatible with 13-19 actuators



**PART NO.**  
**801802000** BLACK  
**801803000** RED

Material: Nylon  
Finish: Gloss

Cap  
Compatible with 13-19 actuators



**PART NO.**  
**452D02000** BLACK  
**452D03000** RED

Material: Nylon  
Finish: Gloss

Cap  
Compatible with 13-19 actuators



**PART NO.**  
**894102000** BLACK  
**894103000** RED

Material: Nylon  
Finish: Gloss

Cap  
Compatible with 13-19 actuators

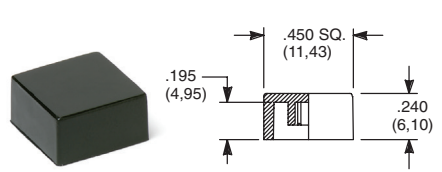

**PART NO.**  
**484602000** BLACK  
**484603000** RED

**PART NO.**  
**798202263** BLACK  
**798203000** RED

Material: Nylon  
Finish: Gloss

Material: Nylon  
Finish: Matte

Cap  
Compatible with 01-05 actuators



**PART NO.**  
**120100602** BLACK

Material: Nylon  
Finish: Matte

**NOTE:** Other colors available,  
consult Customer Service Center.



Dimensions are shown: Inch (mm)  
Specifications and dimensions subject to change

Компания «Океан Электроники» предлагает заключение долгосрочных отношений при поставках импортных электронных компонентов на взаимовыгодных условиях!

Наши преимущества:

- Поставка оригинальных импортных электронных компонентов напрямую с производств Америки, Европы и Азии, а так же с крупнейших складов мира;
- Широкая линейка поставок активных и пассивных импортных электронных компонентов (более 30 млн. наименований);
- Поставка сложных, дефицитных, либо снятых с производства позиций;
- Оперативные сроки поставки под заказ (от 5 рабочих дней);
- Экспресс доставка в любую точку России;
- Помощь Конструкторского Отдела и консультации квалифицированных инженеров;
- Техническая поддержка проекта, помощь в подборе аналогов, поставка прототипов;
- Поставка электронных компонентов под контролем ВП;
- Система менеджмента качества сертифицирована по Международному стандарту ISO 9001;
- При необходимости вся продукция военного и аэрокосмического назначения проходит испытания и сертификацию в лаборатории (по согласованию с заказчиком);
- Поставка специализированных компонентов военного и аэрокосмического уровня качества (Xilinx, Altera, Analog Devices, Intersil, Interpoint, Microsemi, Actel, Aeroflex, Peregrine, VPT, Syfer, Eurofarad, Texas Instruments, MS Kennedy, Miteq, Cobham, E2V, MA-COM, Hittite, Mini-Circuits, General Dynamics и др.);

Компания «Океан Электроники» является официальным дистрибьютором и эксклюзивным представителем в России одного из крупнейших производителей разъемов военного и аэрокосмического назначения «JONHON», а так же официальным дистрибьютором и эксклюзивным представителем в России производителя высокотехнологичных и надежных решений для передачи СВЧ сигналов «FORSTAR».



## JONHON

«JONHON» (основан в 1970 г.)

Разъемы специального, военного и аэрокосмического назначения:

(Применяются в военной, авиационной, аэрокосмической, морской, железнодорожной, горно- и нефтедобывающей отраслях промышленности)

«FORSTAR» (основан в 1998 г.)

ВЧ соединители, коаксиальные кабели,  
кабельные сборки и микроволновые компоненты:

(Применяются в телекоммуникациях гражданского и специального назначения, в средствах связи, РЛС, а так же военной, авиационной и аэрокосмической отраслях промышленности).



Телефон: 8 (812) 309-75-97 (многоканальный)

Факс: 8 (812) 320-03-32

Электронная почта: [ocean@oceanchips.ru](mailto:ocean@oceanchips.ru)

Web: <http://oceanchips.ru/>

Адрес: 198099, г. Санкт-Петербург, ул. Калинина, д. 2, корп. 4, лит. А