

XC5/XC6/XC7/XC2/XC4 DIN Connectors Series

A Wide Variety of High-density Connectors Conform to International Standards, are Highly Reliable, and Support a Wide Range of Applications

- Lineup includes versatile DIN models that meet international DIN standards, such as standard DIN, DIN-style, and DIN fine-fit models.
- These connectors meet a variety of industrial needs.
- A comprehensive selection of accessories are available.



Connection Examples

● DIP Models



● Fine-fit (press-fit) Models with Multi-tier Stacking

Press-fit connector (with no soldering)

Backplane housing



A wide variety of DIN connectors are available in addition to the following models.

XC5 DIN-style Connectors



	Standard DIN	DIN style 1	DIN style 2
PCB mounting	Fixed at PCB edge	PCB surface mounting	PCB surface mounting

- Designed for PCB surface mounting and ideal for automatic soldering.

XC5K High-profile Stacking Connectors



- Corresponding to a stacking height of 25, 30, or 35 mm.

XC5 Fine-fit (press-fit) Connectors



Construction of Solderless Connecting Part (Fine-fit Part)

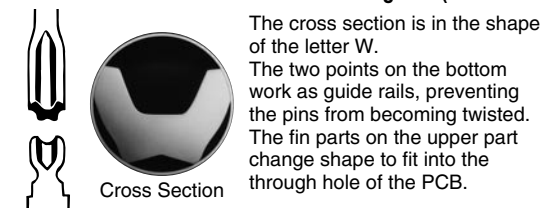

- Press-fitted to PCBs and so soldering or cleaning is required.
- Mounting method more efficient than manual soldering.
- Ideal for backplane systems.

XC5M DIN Connectors in 4 Lines with 128 Connector Poles



	XC5M standard DIN model	XC5M-1 DIN style 1	XC5N DIN style 3
Shape	Plug Right angle terminal	Plug Right angle terminal	Socket Straight terminal

- Multi-pole connectors in 4 lines with 128 poles based on the DIN concept.

XC6 Cable Connectors

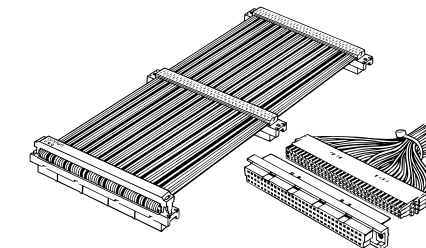
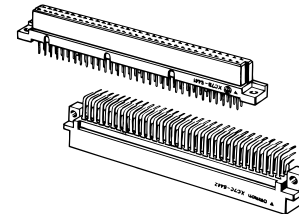

- Ideal for connecting to a variety of bus lines for rack systems.
- Allow backplanes to be constructed with ease.
- Models with 96 connector poles and models with 64 connector poles and a center-holed construction are available.

XC7 Sequence Connectors

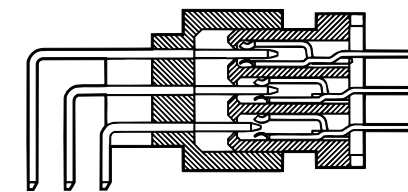

- Active lines can be connected to daughter boards after connecting power lines, and can be disconnected before disconnecting the power lines.
- High reliability ensured with an engagement length of 4 mm and the durability to withstand 5,000 insertions.
- Three-step sequential operation.

XC4 Mid- and High-current Connectors

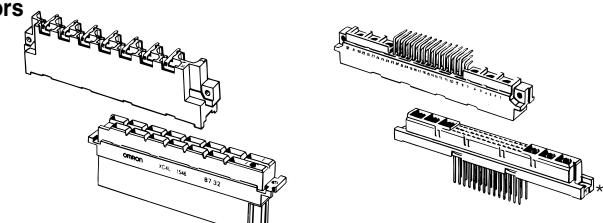
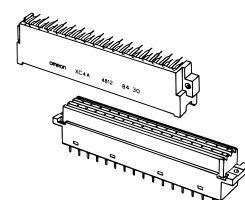

- Carry 6 to 40 A for PCB-to-PCB or PCB-to-wire applications.

*1 (high frequency model available)

XC5/XC6/XC7/XC2/XC4 DIN Connectors Series

Ordering Information

XC5 DIN Connectors

	XC5A 2-Row Plugs (DIN-B Standard Models)	XC5B 2-Row Sockets (DIN-B Standard Models)	XC5E DIP Plugs (DIN-Q Reverse Models)		
Shape	Right angle terminal XC5A-□□22 	Straight terminal XC5B-□□21 	Straight wrapping terminal XC5B-□□23 	Straight terminal XC5E-□□21 	Straight wrapping terminal XC5E-□□23 
Number of contacts	20,32,44,50,64,100	20,32,44,50,64,100	20,32,44,50,64,100		

	XC5F 2-Row Sockets (DIN-Q Reverse Models)	XC5C 3-Row Plugs (DIN-C Standard Models)	XC5D 3-Row Sockets (DIN-C Standard Models)	
Shape	Right angle terminal XC5F-□□22 	Right angle terminal XC5C-□□22 	Straight terminal XC5D-□□21 	Straight wrapping terminal XC5D-□□23 
Number of contacts	20,32,44,50,64,100	32,48,64,96	32,48,64,96	

	XC5G 3-Row Plugs (DIN-R Reverse Models)	XC5H 3-Row Sockets (DIN-R Reverse Models)
Shape	Straight terminal XC5G-□□21 	Straight wrapping terminal XC5G-□□23 
Number of contacts	48,64,96	48,64,96

XC5 DIN Connectors (Twin-contact Model)

	XC5A 2-Row Plugs (DIN Style 1)	XC5B 2-Row Sockets (DIN-style Compatible Models)	XC5E 2-Row Plugs (DIN Style 2)	XC5F 2-Row Sockets (DIN Style 2)
Shape	Right angle terminal XC5A-□□82-1 	Straight terminal XC5B-□□31-0 (with coding key) XC5B-□□31-3 	Straight terminal XC5E-□□81-2 XC5E-□□81-3 * 	Right angle terminal XC5F-□□32-2 
Number of contacts	20,24,26,30,32,44,50,60,64,90,100	10,14,16,20,24,26,30,32,40,44,50,60,64,80,90,100	10*,14*,20,24*,30,32,40*,44,50,60,64,80,90,100	20,30,32,40,44,50,60,64,90,100

	XC5K High-profile Stacking Plugs	XC5C 3-Row Plugs (DIN Style 1)	XC5D 3-Row Sockets (DIN Style Compatible)	XC5H 3-Row Sockets (DIN Style 1)
Shape	XC5K-□□31-4A with 35-mm-pitch Straight terminal XC5K-□□31-3A with 30-mm-pitch Straight terminal XC5K-□□31-2A with 25-mm-pitch Straight terminal 	Right angle terminal XC5C-□□82-1 	Straight terminal XC5D-□□31-0 	Right angle terminal XC5H-□□32-1 
Number of contacts	16,20,32	64,96	64,96	64,96

XC5 DIN Connectors (Fine-fit, W-shaped terminal type)

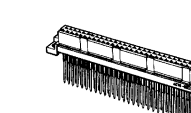
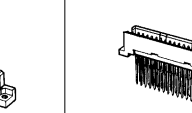
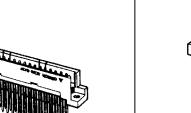
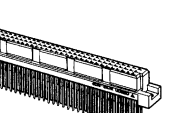
	XC5B 2-Row Sockets (DIN-B Fine-fit, W-terminal Models)	XC5E 2-Row Plugs (DIN-Q Fine-fit, W-terminal Models)	XC5D 3-Row Sockets (DIN-C Fine-fit, W-terminal Models)	XC5G 3-Row Plugs (DIN-R Fine-fit, W-terminal Models)
Shape	Straight terminal XC5B-□□2P-1140 *1 XC5B-□□2P-1131 *2 XC5B-□□2P-1132 *3 	Straight terminal XC5E-□□2P-1140 *1 XC5E-□□2P-1131 *2 XC5E-□□2P-1132 *3 	Straight terminal XC5D-□□2P-1140 *1 XC5D-□□2P-1131 *2 XC5D-□□2P-1132 *3 	Straight terminal XC5G-□□2P-1140 *1 XC5G-□□2P-1131 *2 XC5G-□□2P-1132 *3 
Number of contacts	32,64,100	32,64,100	48,64,96	48,64,96

*1: Terminal type/ Straight, 4mm *2: Terminal type/ Straight, 13mm *3: Terminal type/ Straight, 17mm

XC5 DIN Connectors (4-Rows and 128 Contacts type)

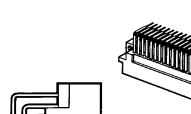
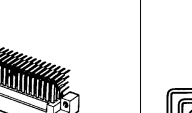
	XC5M 4-Row Plugs	XC5N 4-Row Sockets
Shape	Standard DIN Right angle type terminal XC5M-0222 	DIN Style Right angle terminal XC5M-0222-1 
Number of contacts	128	128

XC6 DIN Connectors (Cable Connecting type)

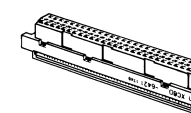
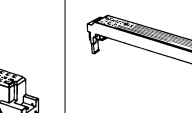
	XC6D Center-holed 2-Row Flat Cables (DIN-C Models)	XC6H 3-Row Flat Cable (DIN-C Models)
Shape	Socket XC6D-6421 	Strain relief XC6T-644 
Number of contacts	64	96

XC6V DIN Connectors (IDC Connectors for Discretedwire)

	Unit housing XC6M-96	Housing without contacts XC6T-32
Shape		

XC5/XC6/XC7/XC2/XC4

DIN Connectors Series

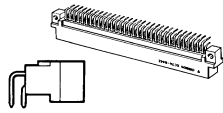
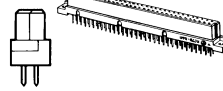
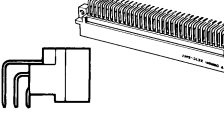
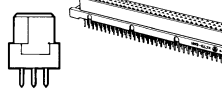

Ordering Information

XC7 DIN Socket Sequence Connectors

	XC7A 2-Row Plugs	XC7B 2-Row Sockets	XC7C 3-Row Plugs	XC7D 3-Row Sockets
Shape	Right angle terminal XC7A-□□42-N001 *1 XC7A-□□42-N003 *2 	Straight terminal XC7B-□□41-N001 *1 XC7B-□□41-N003 *2 	Right angle terminal XC7C-9642-N001 *1 XC7C-9642-N003 *2 	Straight terminal XC7D-9641-N001 *1 XC7D-9641-N003 *2 
Number of contacts	64,90,100	64,90,100	96	96

*1:N001→Normal *2:N003→Sequence

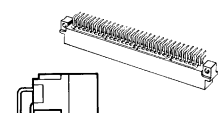
XC2 DIN Connectors

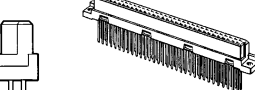
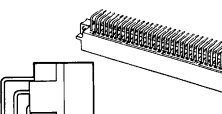
	XC2A 2-Row Plugs (DIN-B standard models)	XC2B 2-Row Sockets (DIN-B standard models)		XC2C 3-Row Plugs (DIN-C standard models)
Shape	Right angle terminal XC2A-6412 	Straight terminal XC2B-6411 	Straight wrapping terminal XC2B-6413 	Right angle terminal XC2C-□□12 
Number of contacts	64	64		64,96

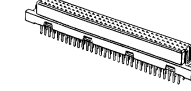
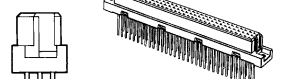
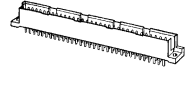
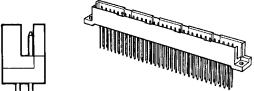
	XC2D 3-Row Sockets (DIN-C standard)		XC2E 2-Row Plugs (DIN-Q Reverse model)	
Shape	Straight terminal XC2D-□□11 	Straight wrapping terminal XC2D-□□13 	Straight terminal XC2E-6411 	Straight wrapping terminal XC2E-6413 
Number of contacts	64,96		64	

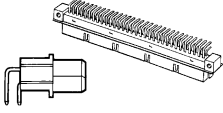
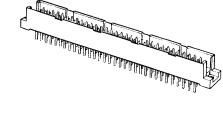
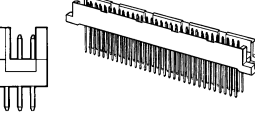
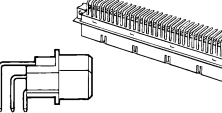
	XC2F 2-Row Sockets (DIN-Q Reverse model)	XC2G 3-Row Plugs (DIN-R Reverse model)		XC2H 3-Row Sockets (DIN-R Reverse model)
Shape	Right angle terminal XC2F-6412 	Straight terminal XC2G-□□11 	Straight wrapping terminal XC2G-□□13 	Right angle terminal XC2H-□□12 
Number of contacts	64	64,96		64,96

XC4 DIN types

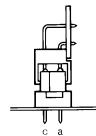
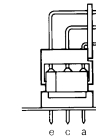
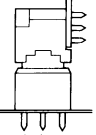
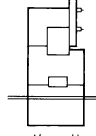
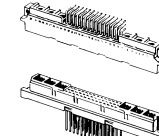
Models	XC4G/H	XC4E/F	XC4A/B	XC4K/L	XC4M/N
DIN	D	E	F	H	M
Shape					

XC4 DIN Connectors (Medium and High-current Connectors)

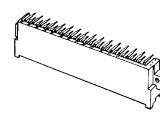
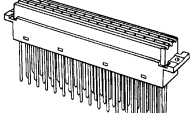
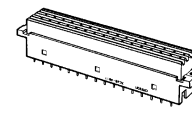
	XC4A Plugs (DIN-F)	XC4B Sockets (DIN-F)	
Shape	Right angle terminal XC4A-4812 	Straight terminal XC4B-4813 	Wrapping terminal XC4B-4811 
Number of contacts	48	48	

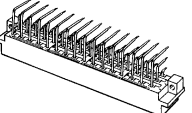
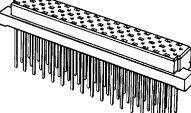
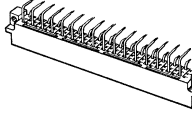
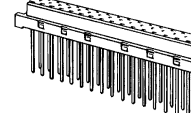
	XC4E Plugs (DIN-E)	XC4F Sockets (DIN-E)	XC4G Plugs (DIN-D)	XC4H Sockets (DIN-D)
Shape	Right angle terminal XC4E-□□12 	Wrapping terminal XC4F-□□13 	Right angle terminal XC4G-3212 	Wrapping terminal XC4H-3213 
Number of contacts	32,48	32,48	32	32

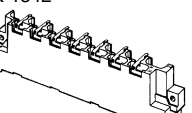
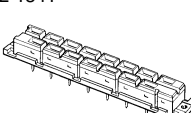
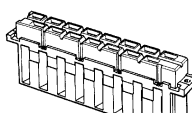
	XC4K Plugs (DIN-H)	XC4L Sockets (DIN-H)	XC4L Sockets(with Fastening Terminals)(DIN-H)
Shape	Right angle terminal XC4K-1542 	Straight terminal XC4L-1541 	with Fasten Terminal XC4L-1546 
Number of contacts	15	15	15

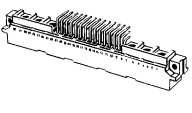
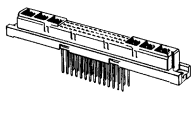
	XC4M Plugs (DIN-M)	XC4N Sockets (DIN-M)
Shape	Right angle terminal XC4M-□□12 	Straight wrapping terminal XC4N-□□13 
Number of contacts	2/78, 4/60, 6/42 *	2/78, 4/60, 6/42 *

*: contacts/ Number of signal circuit poles

XC4W High-current Contacts (for XC4M/XC4N)

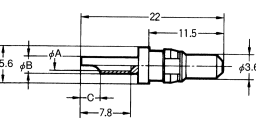
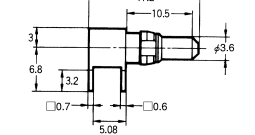
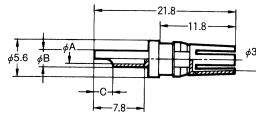
	Plug with Solder Cup Terminal XC4W-□□11	Plug with L-shaped Solder Terminal XC4W-0412	Receptacle with Solder Cup Terminal XC4W-□□11
Shape			
Number of contacts	1,2,4	4	11,12,14

XC4W Co-axial Contacts for XC4M/XC4N

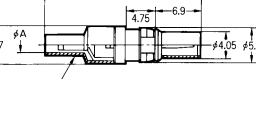
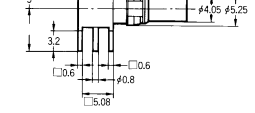
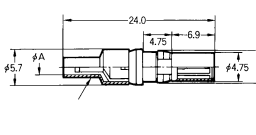
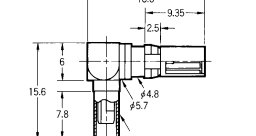
	XC4W-2111(φ2.2) XC4W-2211(φ3.2)	XC4W-2014	XC4W-3111(φ2.2) XC4W-3211(φ3.2)	XC4W-3112(φ2.2) XC4W-3212(φ3.2)
Shape				

Компания «Океан Электроники» предлагает заключение долгосрочных отношений при поставках импортных электронных компонентов на взаимовыгодных условиях!

Наши преимущества:

- Поставка оригинальных импортных электронных компонентов напрямую с производств Америки, Европы и Азии, а так же с крупнейших складов мира;
- Широкая линейка поставок активных и пассивных импортных электронных компонентов (более 30 млн. наименований);
- Поставка сложных, дефицитных, либо снятых с производства позиций;
- Оперативные сроки поставки под заказ (от 5 рабочих дней);
- Экспресс доставка в любую точку России;
- Помощь Конструкторского Отдела и консультации квалифицированных инженеров;
- Техническая поддержка проекта, помощь в подборе аналогов, поставка прототипов;
- Поставка электронных компонентов под контролем ВП;
- Система менеджмента качества сертифицирована по Международному стандарту ISO 9001;
- При необходимости вся продукция военного и аэрокосмического назначения проходит испытания и сертификацию в лаборатории (по согласованию с заказчиком);
- Поставка специализированных компонентов военного и аэрокосмического уровня качества (Xilinx, Altera, Analog Devices, Intersil, Interpoint, Microsemi, Actel, Aeroflex, Peregrine, VPT, Syfer, Eurofarad, Texas Instruments, MS Kennedy, Miteq, Cobham, E2V, MA-COM, Hittite, Mini-Circuits, General Dynamics и др.);

Компания «Океан Электроники» является официальным дистрибьютором и эксклюзивным представителем в России одного из крупнейших производителей разъемов военного и аэрокосмического назначения «JONHON», а так же официальным дистрибьютором и эксклюзивным представителем в России производителя высокотехнологичных и надежных решений для передачи СВЧ сигналов «FORSTAR».



JONHON

«JONHON» (основан в 1970 г.)

Разъемы специального, военного и аэрокосмического назначения:

(Применяются в военной, авиационной, аэрокосмической, морской, железнодорожной, горно- и нефтедобывающей отраслях промышленности)

«FORSTAR» (основан в 1998 г.)

ВЧ соединители, коаксиальные кабели, кабельные сборки и микроволновые компоненты:

(Применяются в телекоммуникациях гражданского и специального назначения, в средствах связи, РЛС, а так же военной, авиационной и аэрокосмической отраслях промышленности).



Телефон: 8 (812) 309-75-97 (многоканальный)

Факс: 8 (812) 320-03-32

Электронная почта: ocean@oceanchips.ru

Web: <http://oceanchips.ru/>

Адрес: 198099, г. Санкт-Петербург, ул. Калинина, д. 2, корп. 4, лит. А