

Application note

Ceramic Dual Band Monopole Antenna

EGSM900 and PCN1800

10 mm x 3.2 mm x 2 mm Ceramic Chip Antenna

Ground Cleared Under Antenna:

Version 1: 25 mm x 10 mm

Version 2: 40 mm x 10 mm

Pulse Part Number: W3070

Status

Author	MiJu	Version	4.0.0
Checked by		Date	02.07.2009
Approved by		Date	

Pulse Finland Oy

Takatie 6
90440 Kempele, Finland
Tel: +358 207 935 500
Fax: +358 207 935 501

Domicile: Kempele
Business ID: 1933992-8
firstname.lastname@pulseeng.com
www.pulseeng.com/antennas



© 2006. All Rights Reserved.

Table of Content

General Features and Applications	3
Terminal configuration and antenna dimensions.....	4
Test setup for electrical measurements	5
Electrical performance test results.....	7
Packing	13
Mechanical Outline	16
Contact information	17

Pulse Finland Oy

Takatie 6
90440 Kempele, Finland
Tel: +358 207 935 500
Fax: +358 207 935 501

Domicile: Kempele
Business ID: 1933992-8
firstname.lastname@pulseeng.com
www.pulseeng.com/antennas



Ceramic Chip Antenna

Ground Cleared Under Antenna

Features

- Low profile
- Compact size W x L x H (10 x 3.2 x 2 mm)
- Low weight (240 mg)
- Lead free materials
- Fully SMD compatible
- Lead free soldering compatible
- Tape and reel packing
- RoHS Compliant Product

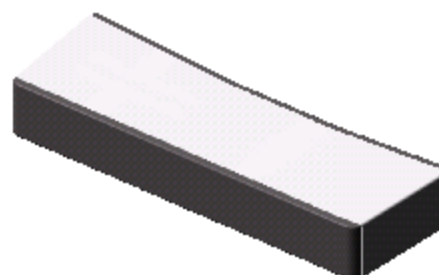

Applications

- EGSM900 and PCN1800 radios

Electrical specifications @ +25 °C

Note: Electrical characteristics depend on test board (GP) size and antenna positioning on GP and Ground Clearance area size.

W3070 Ceramic Dual Band Monopole Antenna (Version 1: Ground Cleared Under Antenna 25 mm x 10mm)

Typical performance (test board size 95 mm x 40 mm, PWB ground clearance area 25 mm x 10 mm)

18nH and 10nH series-inductors used for frequency tuning and 6.8nH shunt-inductor used for impedance matching.

Frequency Range [MHz]	3D Max Gain [dBi]	3D Efficiency [%] / [dB]	Return loss min. [dB]	Impedance [Ω]	Operating Temperature [°C]
880 - 960	+1.5 (peak) -0.4 (band edges)	70 / -1.55 (peak) 47 ; 40 / -3.3 ; -4 (band edges)	-4.7 ; -3.8 (band edges)	50	-40 to +85
1710 – 1880	+1 (peak) -1 ; +0.5 (band edges)	50 / -3 (peak) 30 ; 40 / -5.2 ; -4 (band edges)	-4 ; -4.6 (band edges)	50	-40 to +85

W3070 Ceramic Dual Band Monopole Antenna (Version 2: Ground Cleared Under Antenna 40 mm x 10mm)

Typical performance (test board size 95 mm x 40 mm, PWB ground clearance area 40 mm x 10 mm)

18nH and 10nH series-inductors used for frequency tuning.

Frequency Range [MHz]	3D Max Gain [dBi]	3D Efficiency [%] / [dB]	Return loss min. [dB]	Impedance [Ω]	Operating Temperature [°C]
880 - 960	+1.2 (peak) -0.4 (band edges)	65 / -1.9 (peak) 47 / -3.3 (band edges)	-5.1 ; -5.3 (band edges)	50	-40 to +85
1710 – 1880	+2.5 (peak) +1.5 ; +2 (band edges)	60 / -2.2 (peak) 50 ; 55 / -3 ; -2.6 (band edges)	-5.8 ; -5.7 (band edges)	50	-40 to +85

Pulse Finland Oy

Takatie 6
90440 Kempele, Finland
Tel: +358 207 935 500
Fax: +358 207 935 501

Domicile: Kempele
Business ID: 1933992-8
firstname.lastname@pulseeng.com
www.pulseeng.com/antennas



Ceramic Chip Antenna

Terminal Configuration and Antenna Dimensions

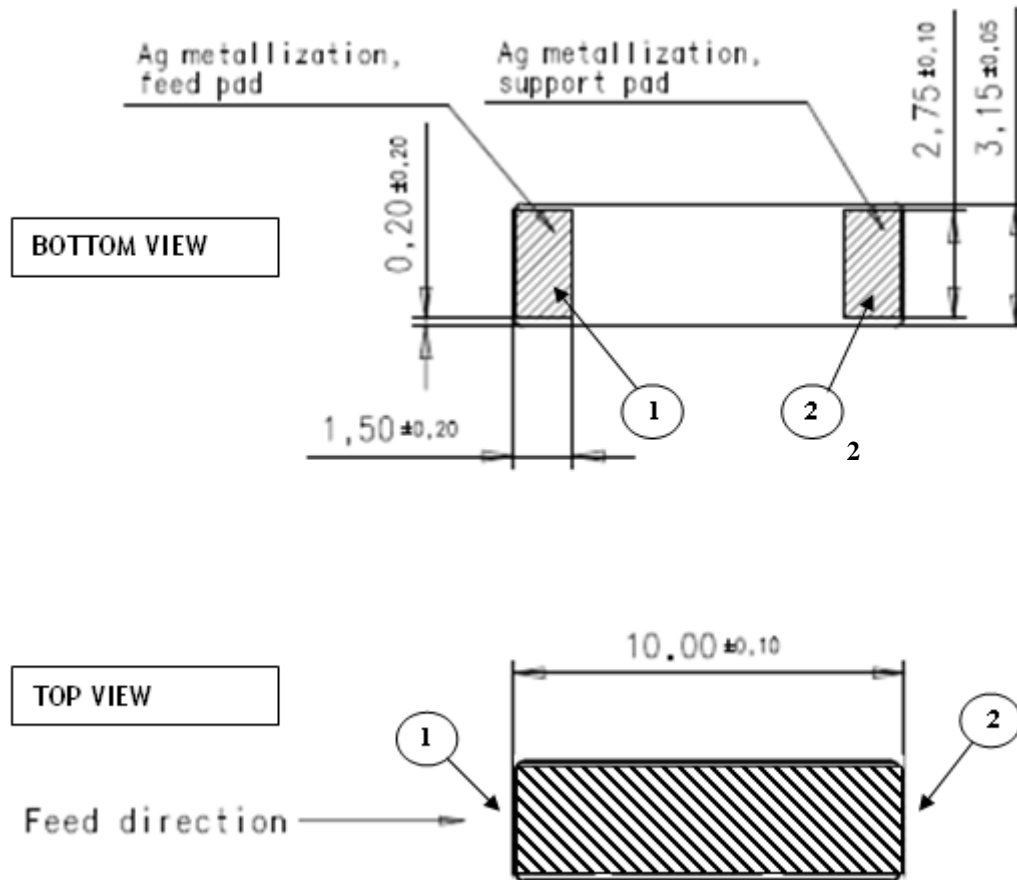

No.	Terminal Name	Terminal Dimensions
1	Feed	1.5 x 2.75 mm
2	Support pad	1.5 x 2.75 mm

Antenna is symmetrical and orientation on footprint can be rotated 180 degrees without change in performance

Ceramic Chip Antenna

Test Setup for Electrical Measurements

Recommended test board- layout for electrical characteristic measurement. Test board outline size 95 x 40mm.

Ground cleared under antenna, clearance area **25 mm x 10 mm**

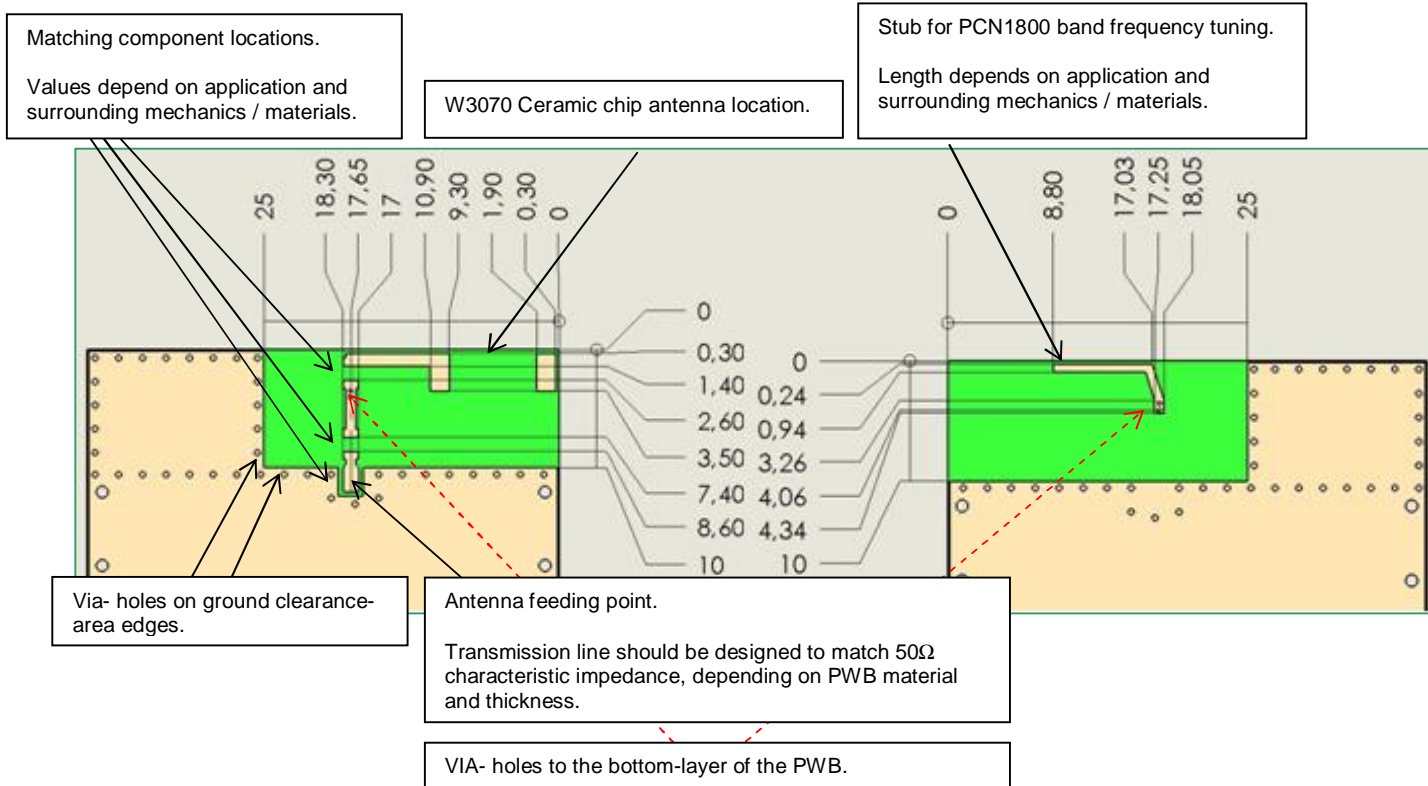

Ground cleared under antenna, clearance area **40 mm x 10 mm**

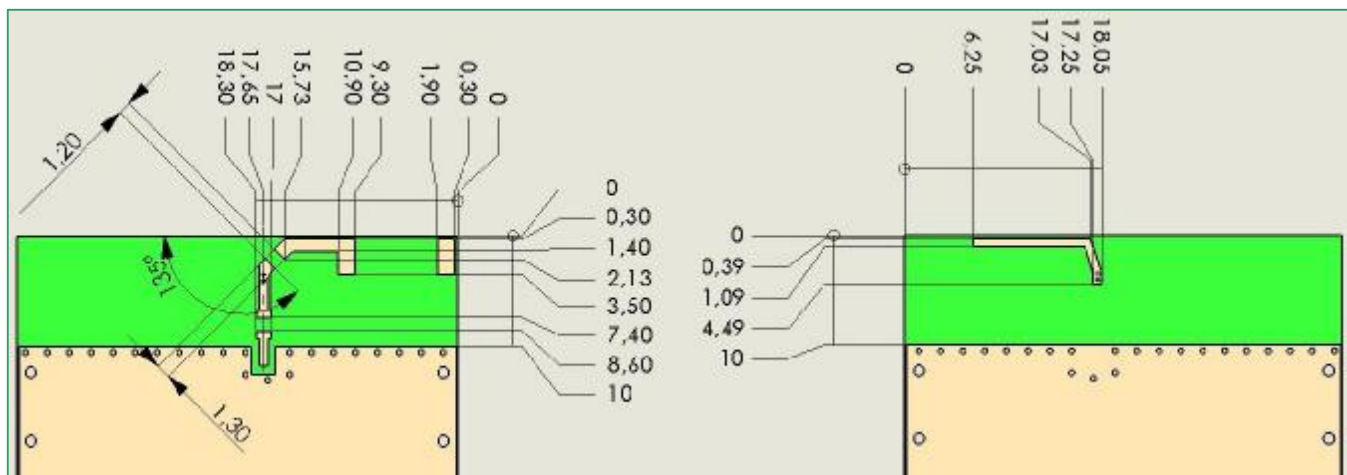

Recommended test board- layout for electrical characteristic measurement. Test board outline size 95 x 40mm.

3D- view of Test Setup

Ground cleared under antenna, clearance area **25 mm x 10 mm**

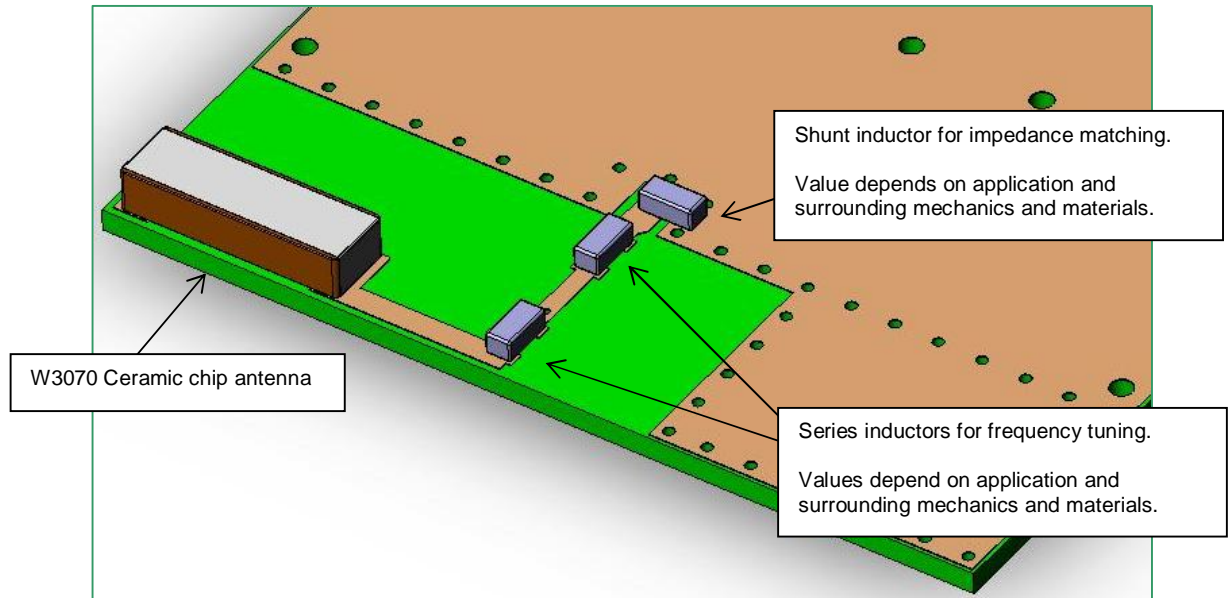

3D- view of Test Setup

Ground cleared under antenna, clearance area **40 mm x 10 mm**

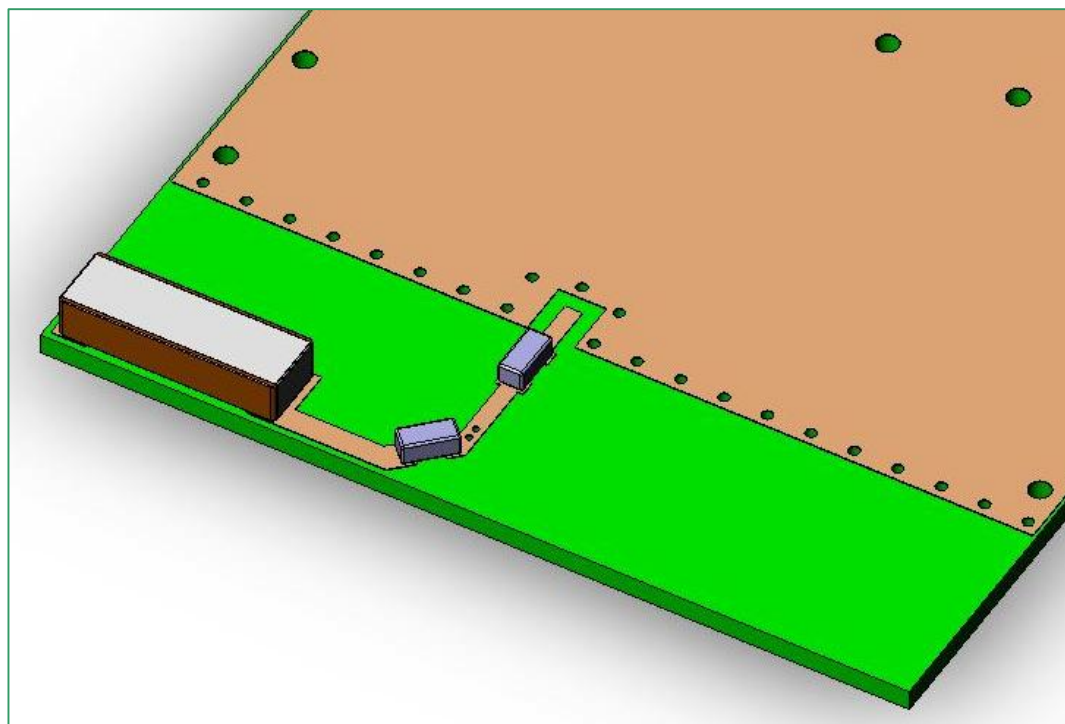

Pulse Finland Oy

Takatie 6
90440 Kempele, Finland
Tel: +358 207 935 500
Fax: +358 207 935 501

Domicile: Kempele
Business ID: 1933992-8
firstname.lastname@pulseeng.com
www.pulseeng.com/antennas

Ceramic Chip Antenna

Ground cleared under antenna. Clearance areas **25 mm x 10 mm** and **40mm x 10mm**.

Typical Electrical Characteristics (T=25 °C)

Measured on the 95 x 40mm test board with matching circuit.

Typical Return Loss S11

Typical return loss-values at band edges:

880MHz	960MHz
-5.1dB	-5.3dB
-4.7dB	-3.8dB
1710MHz	1880MHz
-5.8dB	-5.7dB
-4dB	-4.6dB

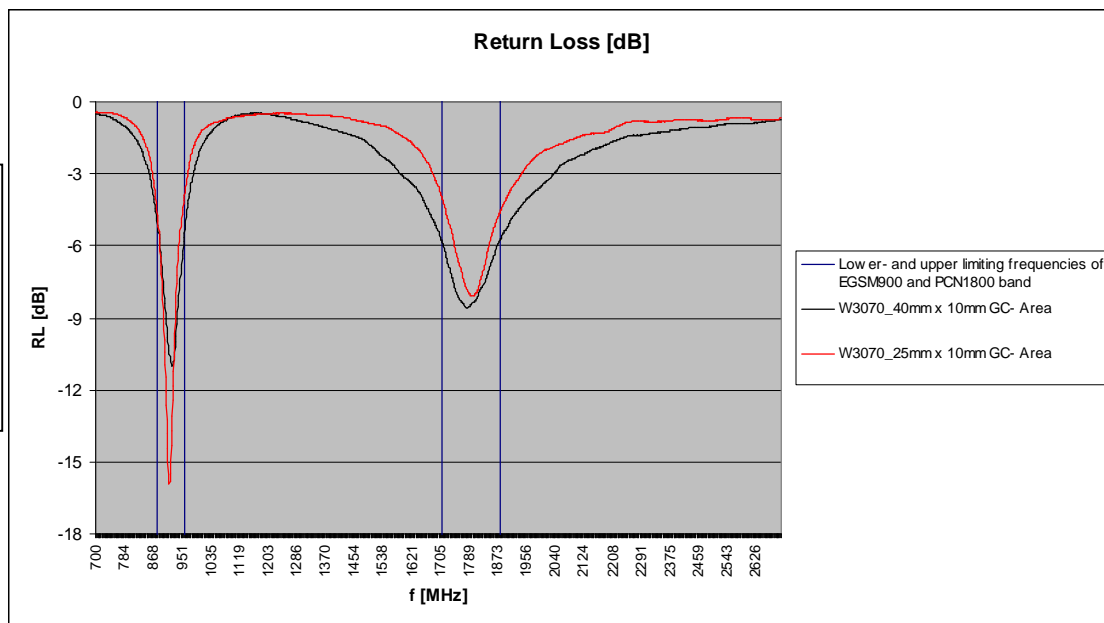

Typical free Space Total Efficiencies [%]

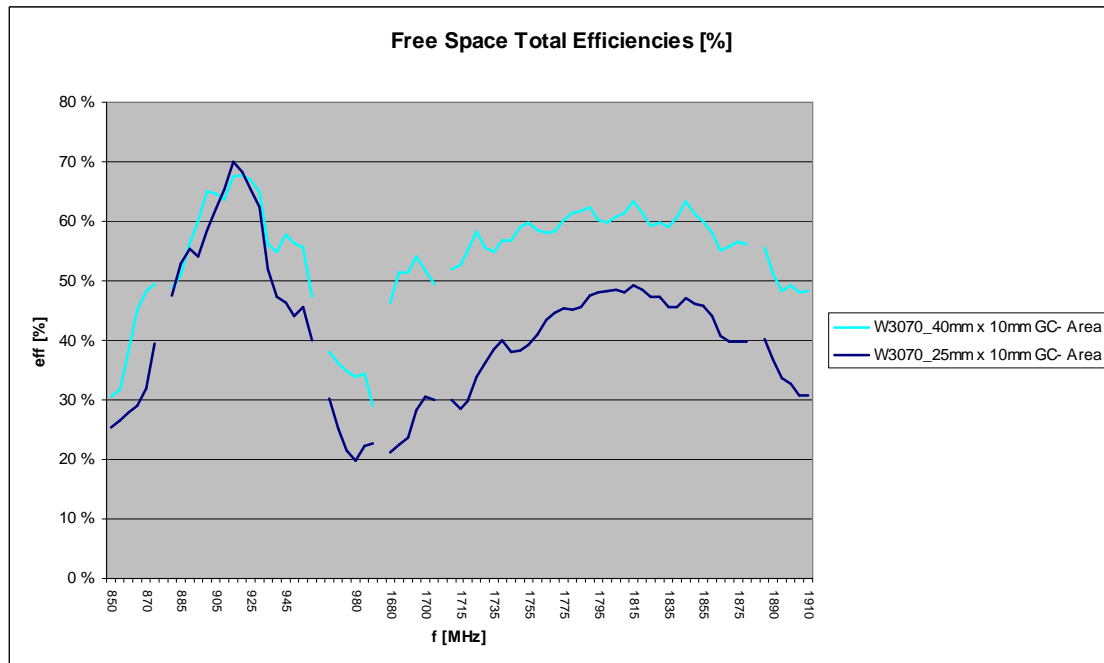

Typical free Space Total Efficiencies [dB] and Maximum Gain [dBi]

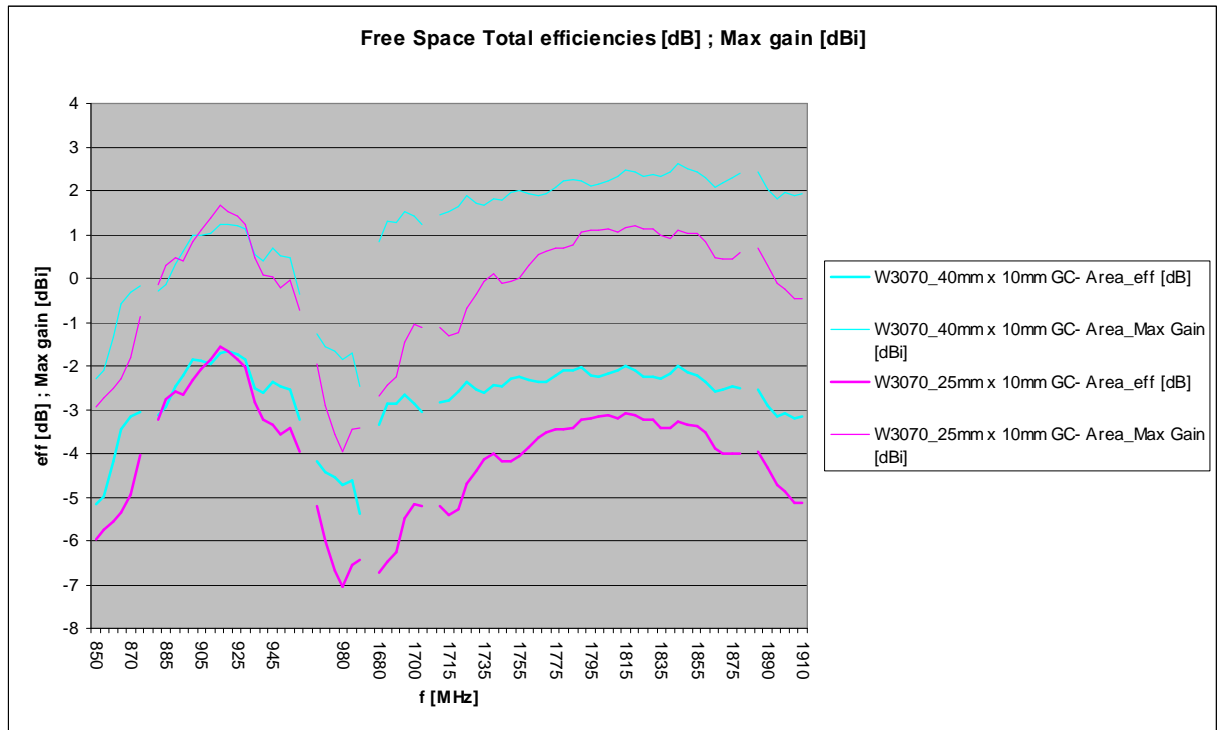

Pulse Finland Oy

Takatie 6
 90440 Kempele, Finland
 Tel: +358 207 935 500
 Fax: +358 207 935 501

Domicile: Kempele
 Business ID: 1933992-8
firstname.lastname@pulseeng.com
www.pulseeng.com/antennas



Ceramic Chip Antenna

Ground cleared under antenna. Clearance area **25 mm x 10mm**.

Typical Free Space Radiation Patterns for EGSM900 Band

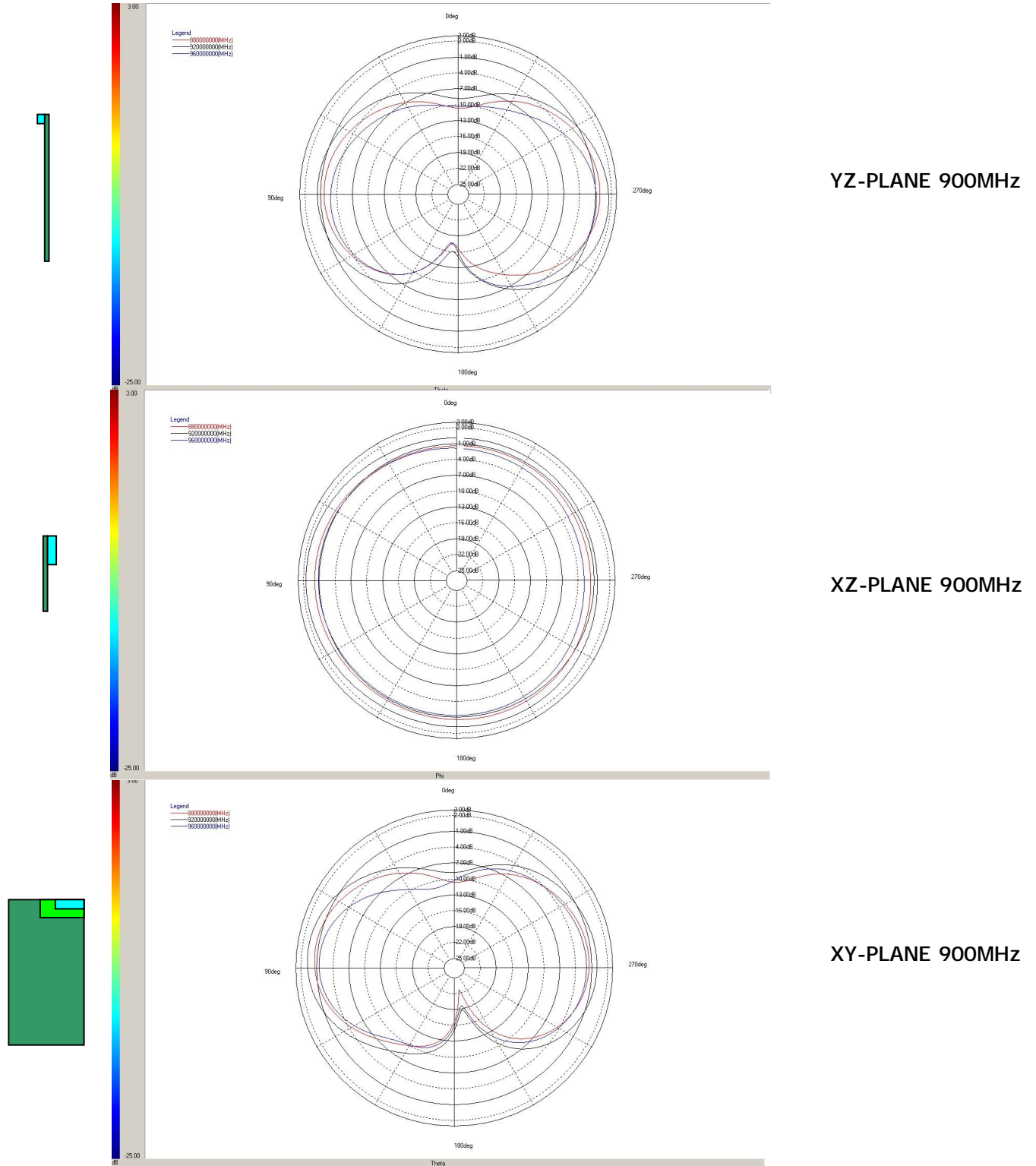

Typical Free Space Radiation Patterns for PCN1800 Band

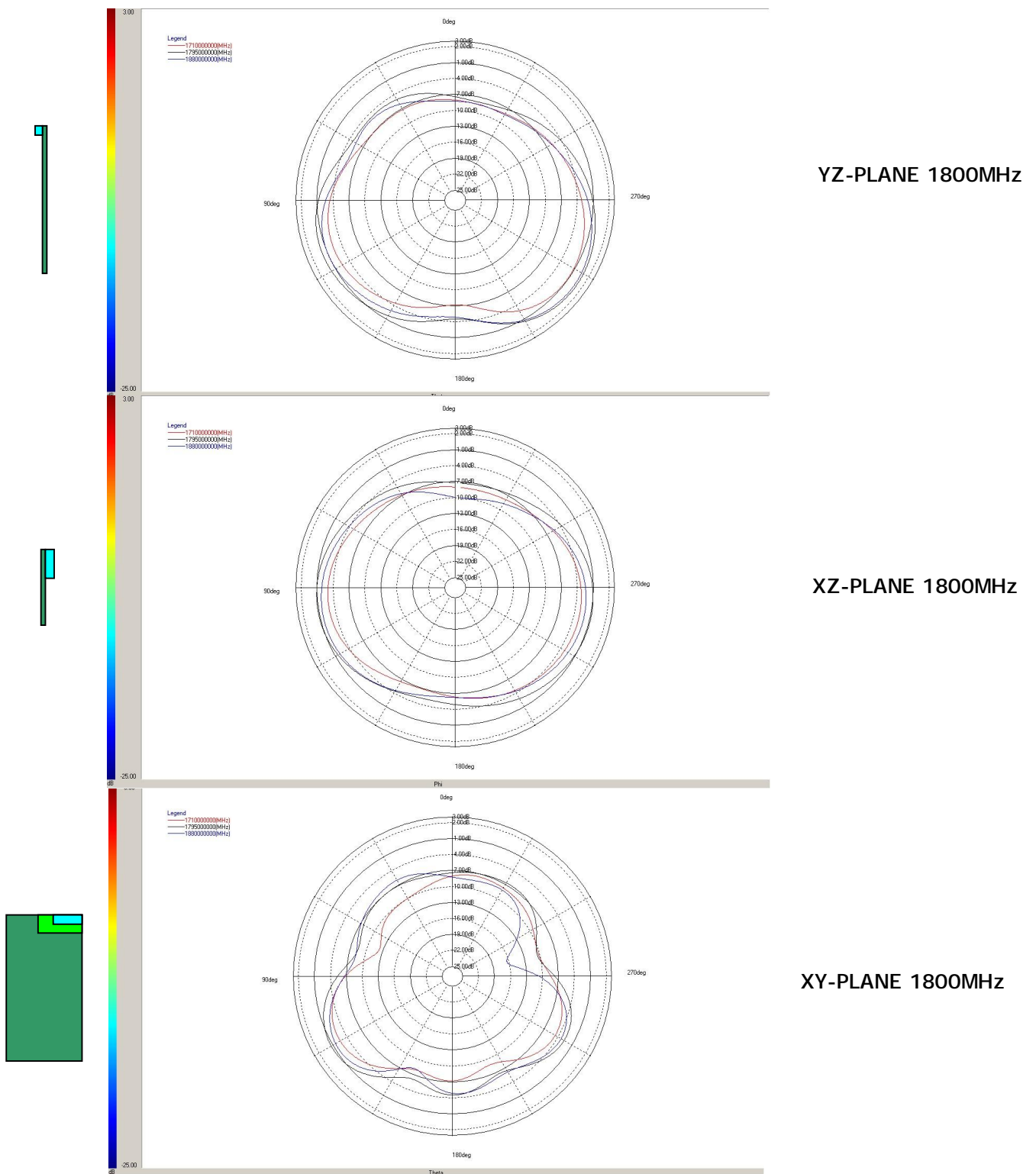

Ceramic Chip Antenna

Ground cleared under antenna. Clearance area **40 mm x 10mm**.

Typical Free Space Radiation Patterns for EGSM900 Band

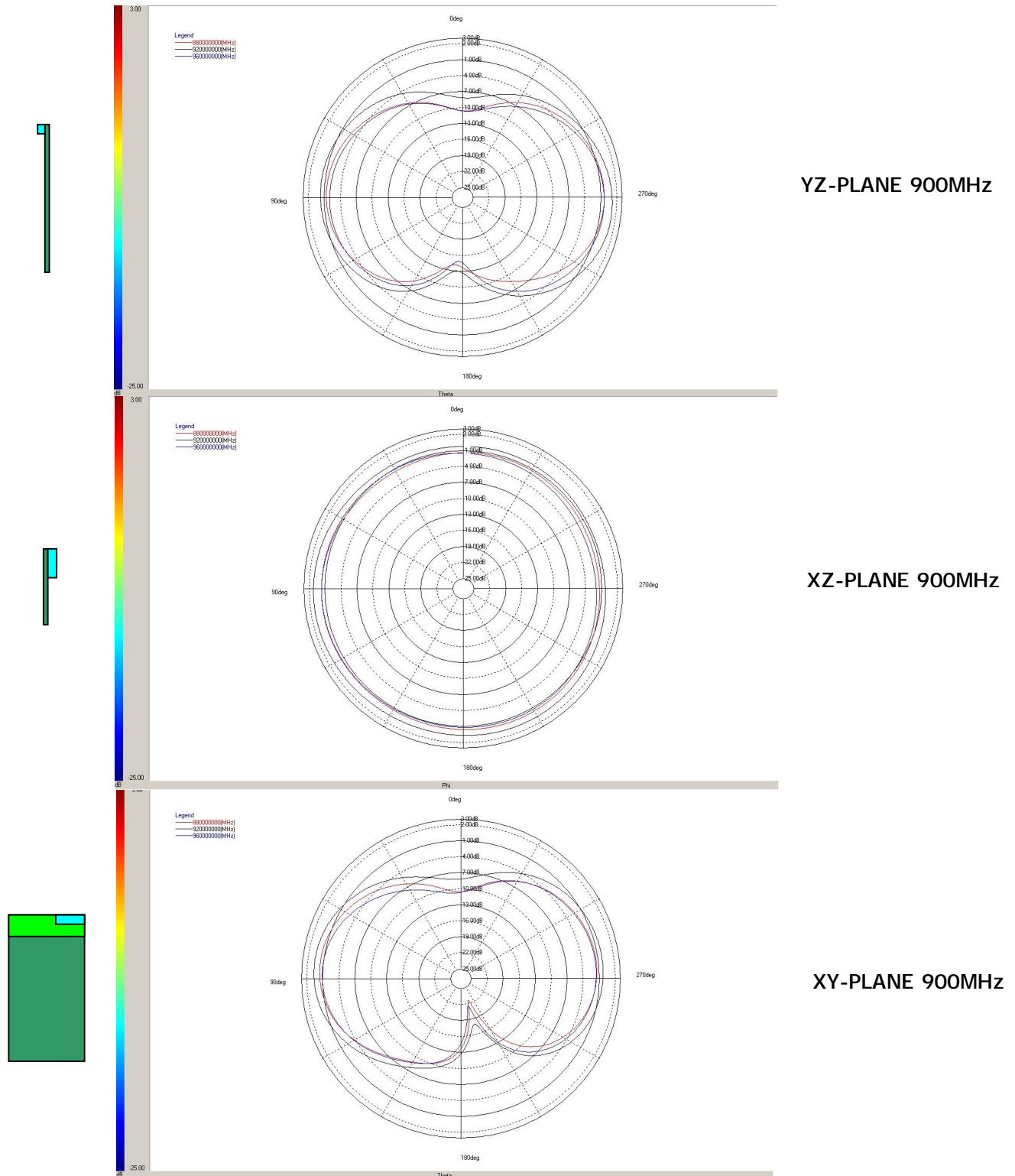

Typical Free Space Radiation Patterns for PCN1800 Band

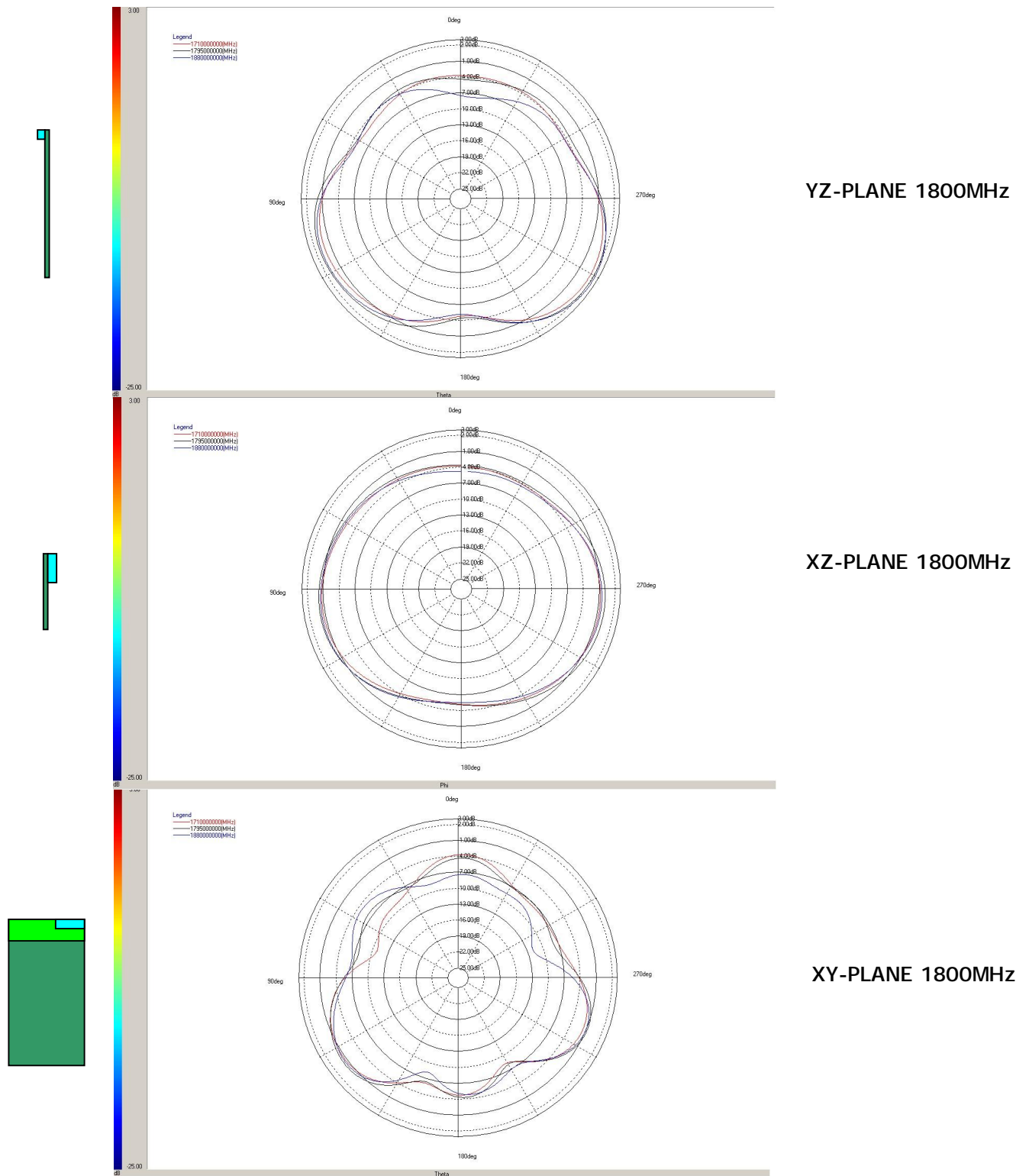

Ceramic Chip Antenna

Packing

General

Tape and reel packing is used. Carrier tape, reel and box dimensions are presented in following pictures.

Carrier tape

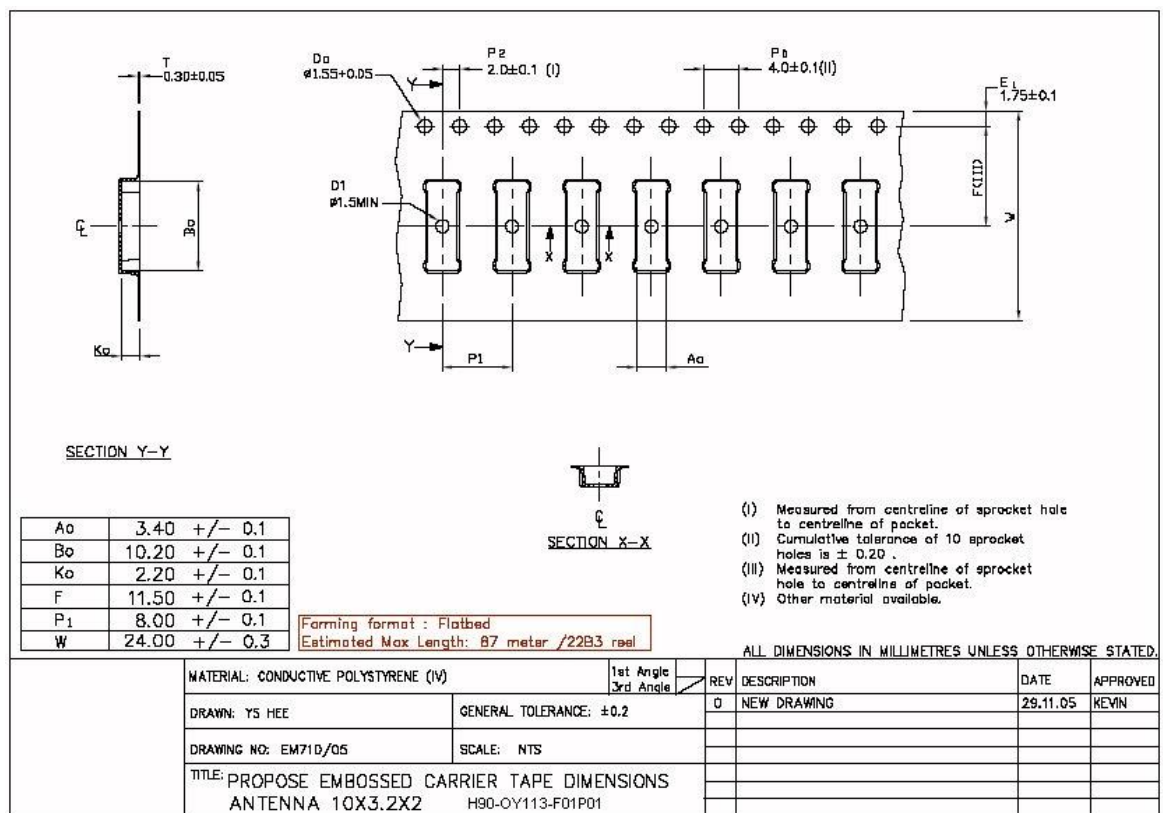

Block orientation

Antenna soldering pads facing down to the bottom of the carrier tape.

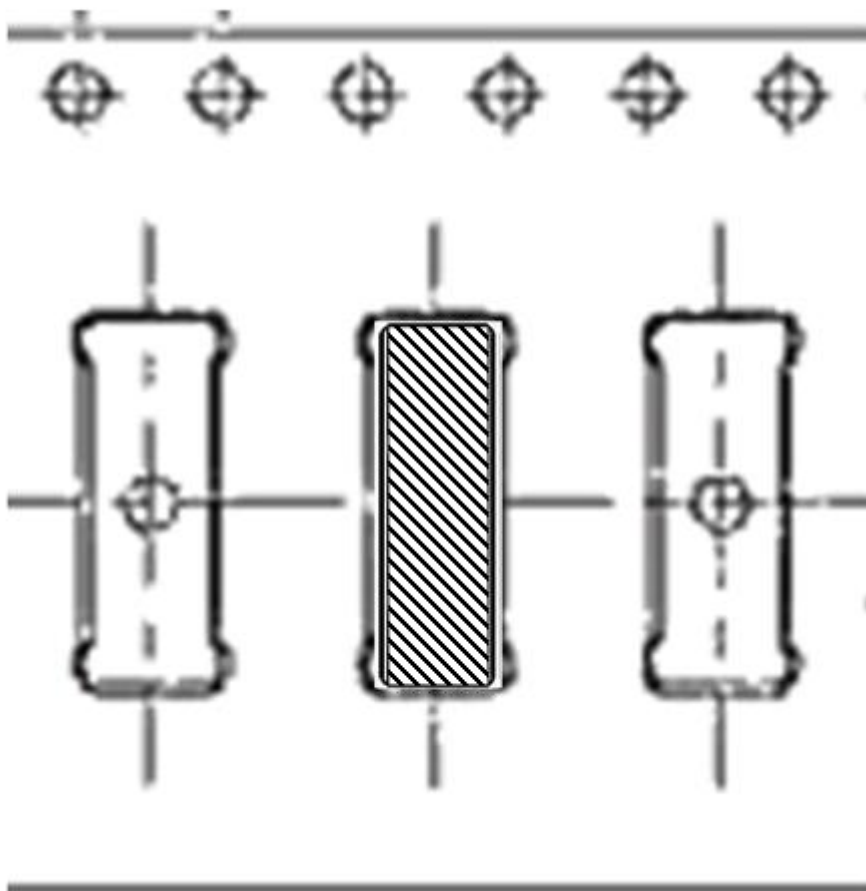

Pulse Finland Oy

Takatie 6
90440 Kempele, Finland
Tel: +358 207 935 500
Fax: +358 207 935 501

Domicile: Kempele
Business ID: 1933992-8
firstname.lastname@pulseeng.com
www.pulseeng.com/antennas



© 2006. All Rights Reserved.

Packing form

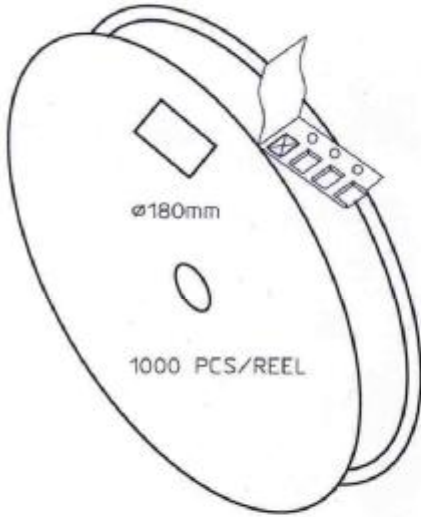
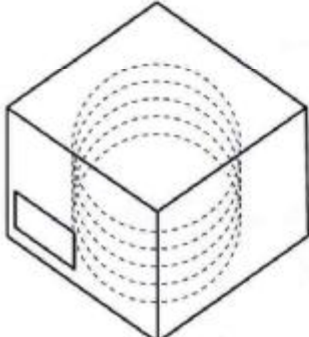
CARRIER TAPE H85-00168
width=24,00 depth=2.20
COVER TAPE H85-00159
width=21.20

LENGTH OF TAPE:

- Leader section: min 350 mm before component section
- Trailer section: min 40 mm after component section.

Empty part cavities at leader and trailer section of the tape must be sealed with top cover tape.

BOX H85-00128 (182x182x125)	1 pcs
- LABEL	1 pcs/BOX
REEL H85-00160 (D180, W28)	4 pcs
- REEL LABEL	1 pcs/REEL

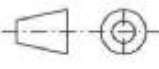
MATERIAL			
HANDLINGS			
		RATIO	DRWN 160107 PeHa H
			DGNER
			CHKD
			APPRD
			APPRD BY
PRODUCT H90-OY113-F01P01			C
DENOMINATION PACKING FORM			B
			A
VERSION		MOD/DATE/NAME	

Ceramic Chip Antenna

Mechanical Outline

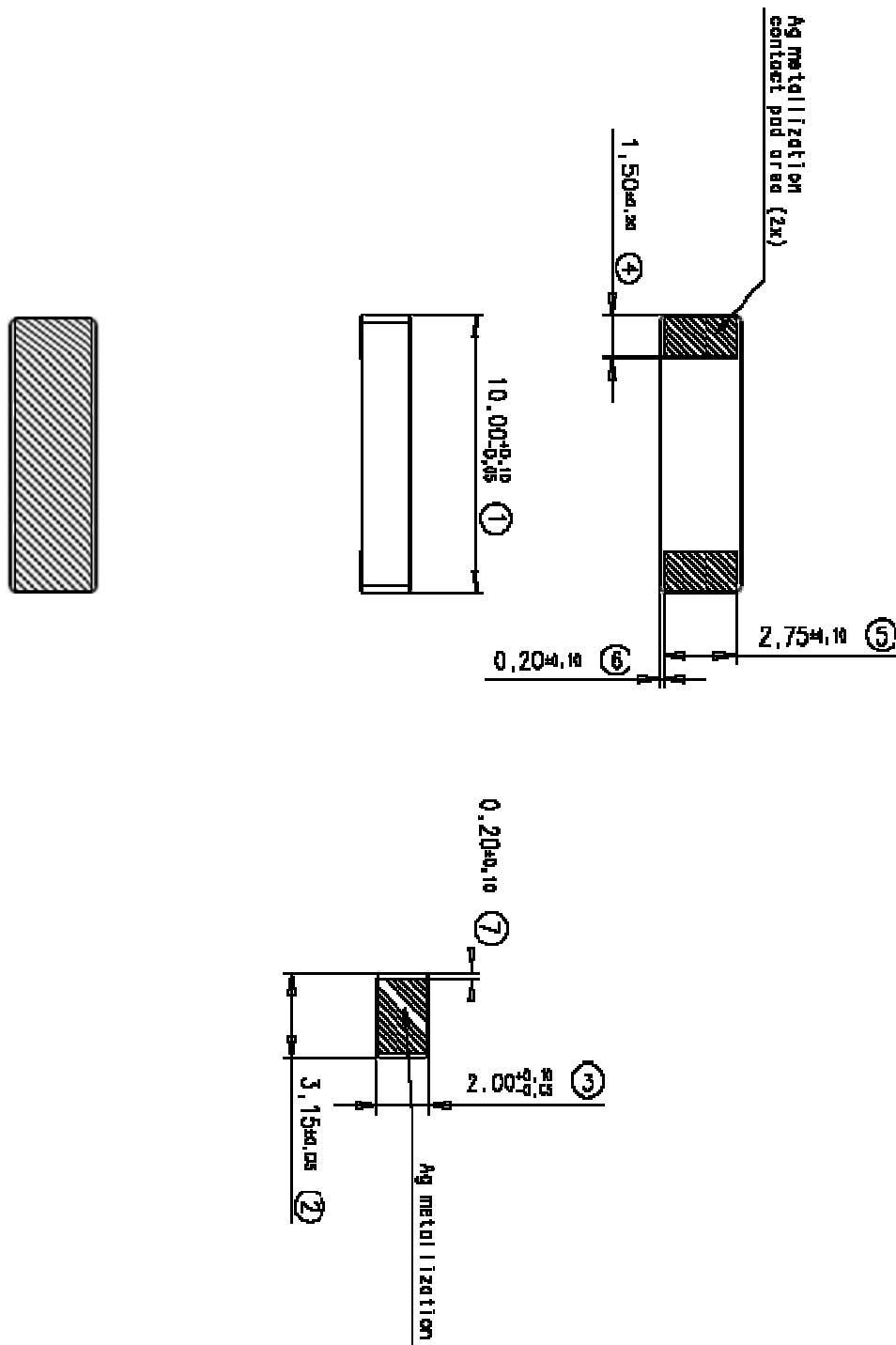

For More Information, please contact:

Pulse Finland Oy

Takatie 6

Fin-90440 Kempele

Finland

Tel. +358 207 935 500

Fax +358 207 935 501 (sales)

Domicile: Kempele

Business ID: 1933992-8

firstname.lastname@pulseeng.com

www.pulseeng.com/antennas

Pulse World Wide Headquarters

12220 World Trade Drive

San Diego, CA 92128

U.S.A

Tel. +1 858 674 8100

Fax +1 858 674 826

www.pulseeng.com

This is a "Preliminary" product application notes. Products mentioned on this application notes are in development and in the process of being qualified. These products are not fully released nor are they in production. Features, specifications and performance of products offered are subject to change without notice. Other brand and product names mentioned herein may be products and/or registered trademarks of their respective ones. For current info on this product, please contact the Pulse San Diego office.

© Copyright, 2006. Pulse Finland Oy. All rights reserved.

Pulse Finland Oy

Takatie 6

90440 Kempele, Finland

Tel: +358 207 935 500

Fax: +358 207 935 501

Domicile: Kempele

Business ID: 1933992-8

[firstnamelastname@pulseeng.com](mailto:firstname.lastname@pulseeng.com)

www.pulseeng.com/antennas



© 2006. All Rights Reserved₁₋₇

Компания «Океан Электроники» предлагает заключение долгосрочных отношений при поставках импортных электронных компонентов на взаимовыгодных условиях!

Наши преимущества:

- Поставка оригинальных импортных электронных компонентов напрямую с производств Америки, Европы и Азии, а так же с крупнейших складов мира;
- Широкая линейка поставок активных и пассивных импортных электронных компонентов (более 30 млн. наименований);
- Поставка сложных, дефицитных, либо снятых с производства позиций;
- Оперативные сроки поставки под заказ (от 5 рабочих дней);
- Экспресс доставка в любую точку России;
- Помощь Конструкторского Отдела и консультации квалифицированных инженеров;
- Техническая поддержка проекта, помощь в подборе аналогов, поставка прототипов;
- Поставка электронных компонентов под контролем ВП;
- Система менеджмента качества сертифицирована по Международному стандарту ISO 9001;
- При необходимости вся продукция военного и аэрокосмического назначения проходит испытания и сертификацию в лаборатории (по согласованию с заказчиком);
- Поставка специализированных компонентов военного и аэрокосмического уровня качества (Xilinx, Altera, Analog Devices, Intersil, Interpoint, Microsemi, Actel, Aeroflex, Peregrine, VPT, Syfer, Eurofarad, Texas Instruments, MS Kennedy, Miteq, Cobham, E2V, MA-COM, Hittite, Mini-Circuits, General Dynamics и др.);

Компания «Океан Электроники» является официальным дистрибьютором и эксклюзивным представителем в России одного из крупнейших производителей разъемов военного и аэрокосмического назначения «JONHON», а так же официальным дистрибьютором и эксклюзивным представителем в России производителя высокотехнологичных и надежных решений для передачи СВЧ сигналов «FORSTAR».



JONHON

«JONHON» (основан в 1970 г.)

Разъемы специального, военного и аэрокосмического назначения:

(Применяются в военной, авиационной, аэрокосмической, морской, железнодорожной, горно- и нефтедобывающей отраслях промышленности)

«FORSTAR» (основан в 1998 г.)

ВЧ соединители, коаксиальные кабели, кабельные сборки и микроволновые компоненты:

(Применяются в телекоммуникациях гражданского и специального назначения, в средствах связи, РЛС, а так же военной, авиационной и аэрокосмической отраслях промышленности).



Телефон: 8 (812) 309-75-97 (многоканальный)

Факс: 8 (812) 320-03-32

Электронная почта: ocean@oceanchips.ru

Web: <http://oceanchips.ru/>

Адрес: 198099, г. Санкт-Петербург, ул. Калинина, д. 2, корп. 4, лит. А