

HIGH RIPPLE-REJECTION LOW DROPOUT CMOS VOLTAGE REGULATOR

The S-1111/1121 Series is a positive voltage regulator with a low dropout voltage, high-accuracy output voltage, and low current consumption developed based on CMOS technology.

A built-in low on-resistance transistor provides a low dropout voltage and large output current, and a built-in overcurrent protection circuit prevents the load current from exceeding the current capacity of the output transistor. An ON/OFF circuit ensures a long battery life, and small SOT-23-5 package realize high-density mounting. The lineup includes the S-1111 and S-1121 Series, which differ in pin configuration.

■ Features

- | | |
|--------------------------------------------------|------------------------------------------------------------------------------------------------------------|
| • Output voltage: | 1.5 V to 5.5 V, selectable in 0.1 V step |
| • Output voltage accuracy: | ±1.0% |
| • Dropout voltage: | 200 mV typ. (3.0 V output product, $I_{OUT} = 100$ mA) |
| • Current consumption: | During operation: 35 μ A typ., 65 μ A max.
During power-off: 0.1 μ A typ., 1.0 μ A max. |
| • Output current: | Possible to output 150 mA ($V_{IN} \geq V_{OUT(S)} + 1.0$ V) ^{*1} |
| • Ripple rejection: | 70 dB typ. (f = 1.0 kHz) |
| • Built-in overcurrent protection circuit: | Limits overcurrent of output transistor. |
| • Built-in ON/OFF circuit: | Ensures long battery life. |
| • Operation temperature range: | Ta = -40°C to +85°C |
| • Lead-free, Sn 100%, halogen-free ^{*2} | |

*1. Attention should be paid to the power dissipation of the package when the output current is large.

*2. Refer to "■ Product Name Structure" for details.

■ Applications

- Power supply for battery-powered device
- Power supply for personal communication device
- Power supply for home electric/electronic appliance
- Power supply for cellular phone

■ Package

- SOT-23-5

■ Block Diagram



*1. Parasitic diode

Figure 1

NOT RECOMMENDED FOR NEW DESIGN

■ Product Name Structure

- Users can select the product type, output voltage for the S-1111/1121 Series. Refer to “1. Product name” regarding the contents of product name, “2. Package” regarding the package drawings, “3. Product name list” regarding details of product name.

1. Product name

(1) S-1111 Series

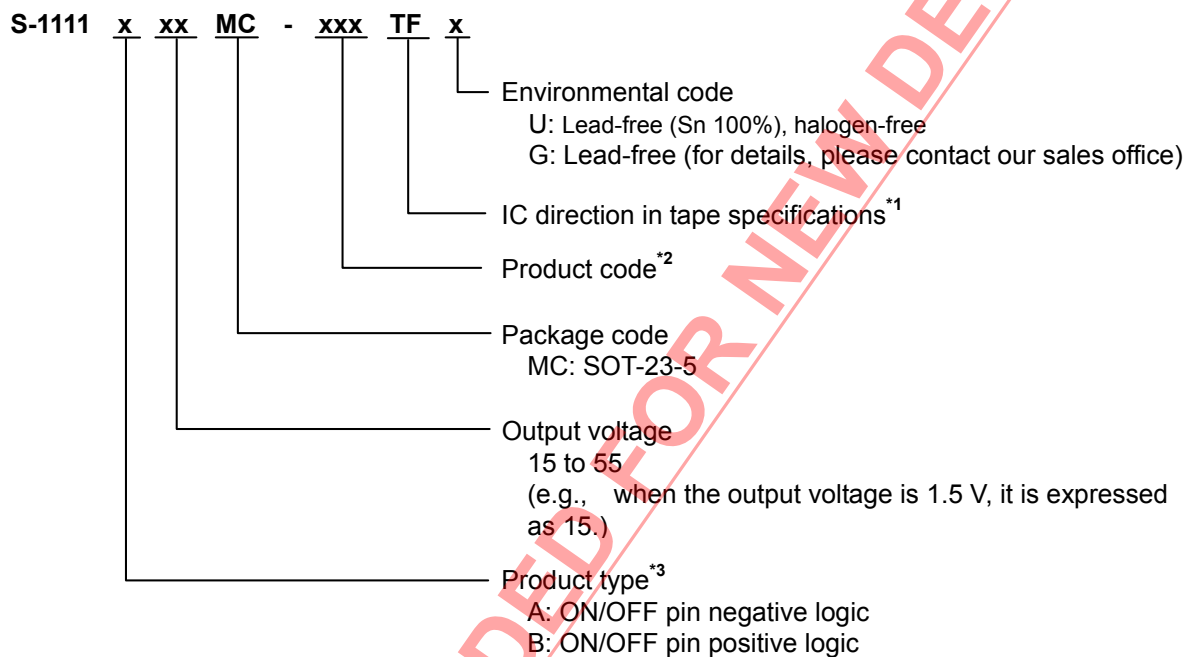

*1. Refer to the tape drawing.

*2. Refer to “3. Product name list”.

*3. Refer to “3. ON/OFF pin” in “■ Operation”.

NOT RECOMMENDED FOR NEW DESIGN

(2) S-1121 Series

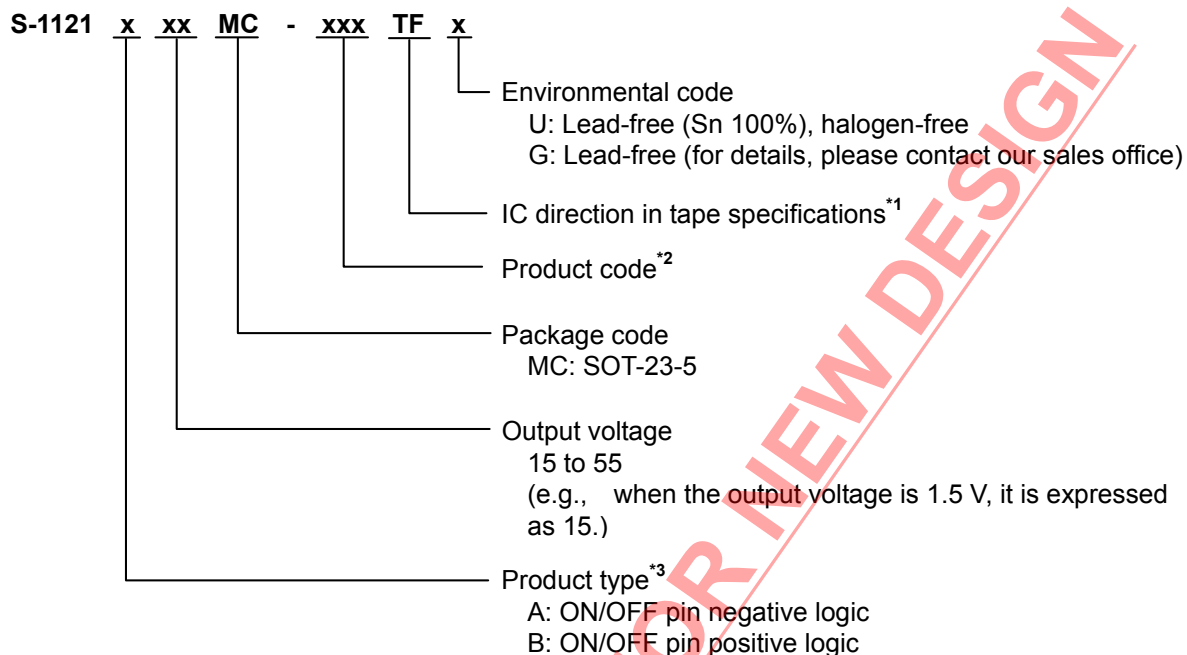

*1. Refer to the tape drawing.

*2. Refer to "3. Product name list".

*3. Refer to "3. ON/OFF pin" in "■ Operation".

2. Package

Package Name	Drawing Code		
	Package	Tape	Reel
SOT-23-5	MP005-A-P-SD	MP005-A-C-SD	MP005-A-R-SD

NOT RECOMMENDED FOR NEW DESIGN

3. Product name list

(1) S-1111 Series

Table 1

Output Voltage	SOT-23-5
1.5V±1.0%	S-1111B15MC-NYATFx
1.6V±1.0%	S-1111B16MC-NYBTFx
1.7V±1.0%	S-1111B17MC-NYCTFx
1.8V±1.0%	S-1111B18MC-NYDTFx
1.9V±1.0%	S-1111B19MC-NYETFx
2.0V±1.0%	S-1111B20MC-NYFTFx
2.1V±1.0%	S-1111B21MC-NYGTFx
2.2V±1.0%	S-1111B22MC-NYHTFx
2.3V±1.0%	S-1111B23MC-NYITFx
2.4V±1.0%	S-1111B24MC-NYJTFx
2.5V±1.0%	S-1111B25MC-NYKTFx
2.6V±1.0%	S-1111B26MC-NYLTFx
2.7V±1.0%	S-1111B27MC-NYMTFx
2.8V±1.0%	S-1111B28MC-NYNTFx
2.9V±1.0%	S-1111B29MC-NYOTFx
3.0V±1.0%	S-1111B30MC-NYPTFx
3.1V±1.0%	S-1111B31MC-NYQTFx
3.2V±1.0%	S-1111B32MC-NYRTFx
3.3V±1.0%	S-1111B33MC-NYSTFx
3.4V±1.0%	S-1111B34MC-NYTTFx
3.5V±1.0%	S-1111B35MC-NYUTFx
3.6V±1.0%	S-1111B36MC-NYVTFx
3.7V±1.0%	S-1111B37MC-NYWTFx
3.8V±1.0%	S-1111B38MC-NYXTFx
3.9V±1.0%	S-1111B39MC-NYYTFx
4.0V±1.0%	S-1111B40MC-NYZTFx
4.1V±1.0%	S-1111B41MC-NZATFx
4.2V±1.0%	S-1111B42MC-NZBTFx
4.3V±1.0%	S-1111B43MC-NZCTFx
4.4V±1.0%	S-1111B44MC-NZDTFx
4.5V±1.0%	S-1111B45MC-NZETFx
4.6V±1.0%	S-1111B46MC-NZFTFx
4.7V±1.0%	S-1111B47MC-NZGTFx
4.75V±1.0%	—
4.8V±1.0%	S-1111B48MC-NZHTFx
4.9V±1.0%	S-1111B49MC-NZITFx
5.0V±1.0%	S-1111B50MC-NZJTFx
5.1V±1.0%	S-1111B51MC-NZKTFx
5.2V±1.0%	S-1111B52MC-NZLTFx
5.3V±1.0%	S-1111B53MC-NZMTFx
5.4V±1.0%	S-1111B54MC-NZNTFx
5.5V±1.0%	S-1111B55MC-NZOTFx

- Remark 1.** Please contact our sales office for type A products.
2. x: G or U
3. Please select products of environmental code = U for Sn 100%, halogen-free products.

(2) S-1121 Series

Table 2

Output Voltage	SOT-23-5
1.5V±1.0%	S-1121B15MC-N2ATFx
1.6V±1.0%	S-1121B16MC-N2BTFx
1.7V±1.0%	S-1121B17MC-N2CTFx
1.8V±1.0%	S-1121B18MC-N2DTFx
1.9V±1.0%	S-1121B19MC-N2ETFx
2.0V±1.0%	S-1121B20MC-N2FTFx
2.1V±1.0%	S-1121B21MC-N2GTFx
2.2V±1.0%	S-1121B22MC-N2HTFx
2.3V±1.0%	S-1121B23MC-N2ITFx
2.4V±1.0%	S-1121B24MC-N2JTFx
2.5V±1.0%	S-1121B25MC-N2KTFx
2.6V±1.0%	S-1121B26MC-N2LTFx
2.7V±1.0%	S-1121B27MC-N2MTFx
2.8V±1.0%	S-1121B28MC-N2NTFx
2.9V±1.0%	S-1121B29MC-N2OTFx
3.0V±1.0%	S-1121B30MC-N2PTFx
3.1V±1.0%	S-1121B31MC-N2QTFx
3.2V±1.0%	S-1121B32MC-N2RTFx
3.3V±1.0%	S-1121B33MC-N2STFx
3.4V±1.0%	S-1121B34MC-N2TTFx
3.5V±1.0%	S-1121B35MC-N2UTFx
3.6V±1.0%	S-1121B36MC-N2VTFx
3.7V±1.0%	S-1121B37MC-N2WTFx
3.8V±1.0%	S-1121B38MC-N2XTFx
3.9V±1.0%	S-1121B39MC-N2YTFx
4.0V±1.0%	S-1121B40MC-N2ZTFx
4.1V±1.0%	S-1121B41MC-N3ATFx
4.2V±1.0%	S-1121B42MC-N3BTFx
4.3V±1.0%	S-1121B43MC-N3CTFx
4.4V±1.0%	S-1121B44MC-N3DTFx
4.5V±1.0%	S-1121B45MC-N3ETFx
4.6V±1.0%	S-1121B46MC-N3FTFx
4.7V±1.0%	S-1121B47MC-N3GTFx
4.75V±1.0%	S-1121B4HMC-N3PTFx
4.8V±1.0%	S-1121B48MC-N3HTFx
4.9V±1.0%	S-1121B49MC-N3ITFx
5.0V±1.0%	S-1121B50MC-N3JTFx
5.1V±1.0%	S-1121B51MC-N3KTFx
5.2V±1.0%	S-1121B52MC-N3LTFx
5.3V±1.0%	S-1121B53MC-N3MTFx
5.4V±1.0%	S-1121B54MC-N3NTFx
5.5V±1.0%	S-1121B55MC-N3OTFx

- Remark**
1. Please contact our sales office for type A products.
 2. x: G or U
 3. Please select products of environmental code = U for Sn 100%, halogen-free products.

■ Pin Configuration

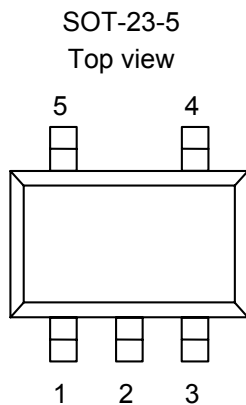

Figure 2

Table 3

(S-1111 Series)

Pin No.	Symbol	Description
1	VIN	Input voltage pin
2	VSS	GND pin
3	ON/OFF	ON/OFF pin
4	NC ^{*1}	No connection
5	VOUT	Output voltage pin

*1. The NC pin is electrically open.
The NC pin can be connected to VIN pin or VSS pin.

Table 4

(S-1121 Series)

Pin No.	Symbol	Description
1	VOUT	Output voltage pin
2	VSS	GND pin
3	VIN	Input voltage pin
4	ON/OFF	ON/OFF pin
5	NC ^{*1}	No connection

*1. The NC pin is electrically open.
The NC pin can be connected to VIN pin or VSS pin.

NOT RECOMMENDED FOR NEW DESIGN

■ **Absolute Maximum Ratings**

Table 5

(Ta = 25 °C unless otherwise specified)

Item	Symbol	Absolute Maximum Rating	Unit
Input voltage	V _{IN}	V _{SS} - 0.3 to V _{SS} + 7	V
	V _{ON/OFF}	V _{SS} - 0.3 to V _{IN} + 0.3	V
Output voltage	V _{OUT}	V _{SS} - 0.3 to V _{IN} + 0.3	V
Power dissipation	P _D	300 (When not mounted on board)	mW
		600 ^{*1}	mW
Operation ambient temperature	T _{opr}	-40 to +85	°C
Storage temperature	T _{stg}	-40 to +125	°C

*1. When mounted on board

[Mounted on board]

(1) Board size : 114.3 mm × 76.2 mm × t1.6 mm

(2) Board name : JEDEC STANDARD51-7

Caution The absolute maximum ratings are rated values exceeding which the product could suffer physical damage. These values must therefore not be exceeded under any conditions.



Figure 3 Power Dissipation of Package (When Mounted on Board)

HIGH RIPPLE-REJECTION LOW DROPOUT CMOS VOLTAGE REGULATOR

Rev.5.1_00

S-1111/1121 Series

■ Electrical Characteristics

Table 6

(Ta = 25 °C unless otherwise specified)

Item	Symbol	Condition	Min.	Typ.	Max.	Unit	Test Circuit	
Output voltage*1	$V_{OUT(E)}$	$V_{IN} = V_{OUT(S)} + 1.0 \text{ V}$, $I_{OUT} = 30 \text{ mA}$	$V_{OUT(S)} \times 0.99$	$V_{OUT(S)}$	$V_{OUT(S)} \times 1.01$	V	1	
Output current*2	I_{OUT}	$V_{IN} \geq V_{OUT(S)} + 1.0 \text{ V}$	150*5	—	—	mA	3	
Dropout voltage*3	V_{drop}	$I_{OUT} = 100 \text{ mA}$	$1.5 \text{ V} \leq V_{OUT(S)} \leq 1.9 \text{ V}$	—	0.60	1.40	V	1
			$2.0 \text{ V} \leq V_{OUT(S)} \leq 2.4 \text{ V}$	—	0.35	0.70	V	1
			$2.5 \text{ V} \leq V_{OUT(S)} \leq 2.7 \text{ V}$	—	0.24	0.35	V	1
			$2.8 \text{ V} \leq V_{OUT(S)} \leq 3.3 \text{ V}$	—	0.20	0.30	V	1
			$3.4 \text{ V} \leq V_{OUT(S)} \leq 5.5 \text{ V}$	—	0.17	0.26	V	1
Line regulation	$\frac{\Delta V_{OUT1}}{\Delta V_{IN} \bullet V_{OUT}}$	$V_{OUT(S)} + 0.5 \text{ V} \leq V_{IN} \leq 6.5 \text{ V}$, $I_{OUT} = 30 \text{ mA}$	—	0.05	0.2	% / V	1	
Load regulation	ΔV_{OUT2}	$V_{IN} = V_{OUT(S)} + 1.0 \text{ V}$, $1.0 \text{ mA} \leq I_{OUT} \leq 80 \text{ mA}$	—	20	40	mV	1	
Output voltage temperature coefficient*4	$\frac{\Delta V_{OUT}}{\Delta T_a \bullet V_{OUT}}$	$V_{IN} = V_{OUT(S)} + 1.0 \text{ V}$, $I_{OUT} = 10 \text{ mA}$, $-40^\circ\text{C} \leq T_a \leq 85^\circ\text{C}$	—	± 100	—	ppm / °C	1	
Current consumption during operation	I_{SS1}	$V_{IN} = V_{OUT(S)} + 1.0 \text{ V}$, ON/OFF pin = ON, no load	—	35	65	μA	2	
Current consumption during power-off	I_{SS2}	$V_{IN} = V_{OUT(S)} + 1.0 \text{ V}$, ON/OFF pin = OFF, no load	—	0.1	1.0	1	2	
Input voltage	V_{IN}		2.0	—	6.5	V	—	
ON/OFF pin input voltage "H"	V_{SH}	$V_{IN} = V_{OUT(S)} + 1.0 \text{ V}$, $R_L = 1.0 \text{ k}\Omega$	1.5	—	—	V	4	
ON/OFF pin input voltage "L"	V_{SL}	$V_{IN} = V_{OUT(S)} + 1.0 \text{ V}$, $R_L = 1.0 \text{ k}\Omega$	—	—	0.3	V	4	
ON/OFF pin input current "H"	I_{SH}	$V_{IN} = 6.5 \text{ V}$, $V_{ON/OFF} = 6.5 \text{ V}$	-0.1	—	0.1	μA	4	
ON/OFF pin input current "L"	I_{SL}	$V_{IN} = 6.5 \text{ V}$, $V_{ON/OFF} = 0 \text{ V}$	-0.1	—	0.1	μA	4	
Ripple rejection	$ RR $	$V_{IN} = V_{OUT(S)} + 1.0 \text{ V}$, $f = 1.0 \text{ kHz}$, $\Delta V_{rip} = 0.5 \text{ Vrms}$, $I_{OUT} = 30 \text{ mA}$	—	70	—	dB	5	
Short-circuit current	I_{short}	$V_{IN} = V_{OUT(S)} + 1.0 \text{ V}$, ON/OFF pin = ON, $V_{OUT} = 0 \text{ V}$	—	250	—	mA	3	

*1. $V_{OUT(S)}$: Set output voltage

$V_{OUT(E)}$: Actual output voltage

Output voltage when fixing $I_{OUT}(= 30 \text{ mA})$ and inputting $V_{OUT(S)} + 1.0 \text{ V}$

*2. The output current at which the output voltage becomes 95% of $V_{OUT(E)}$ after gradually increasing the output current.

*3. $V_{drop} = V_{IN1} - (V_{OUT3} \times 0.98)$

V_{OUT3} is the output voltage when $V_{IN} = V_{OUT(S)} + 1.0 \text{ V}$ and $I_{OUT} = 100 \text{ mA}$.

V_{IN1} is the input voltage at which the output voltage becomes 98% of V_{OUT3} after gradually decreasing the input voltage.

*4. A change in the temperature of the output voltage [mV/°C] is calculated using the following equation.

$$\frac{\Delta V_{OUT}}{\Delta T_a} \text{ [mV/}^\circ\text{C]}^*1 = V_{OUT(S)} \text{ [V]}^*2 \times \frac{\Delta V_{OUT}}{\Delta T_a \bullet V_{OUT}} \text{ [ppm/}^\circ\text{C]}^*3 \div 1000$$

*1. Change in temperature of output voltage

*2. Set output voltage

*3. Output voltage temperature coefficient

*5. The output current can be at least this value.

Due to restrictions on the package power dissipation, this value may not be satisfied. Attention should be paid to the power dissipation of the package when the output current is large.

This specification is guaranteed by design.

■ **Test Circuits**

1.



Figure 4

2.



Figure 5

3.



Figure 6

4.



Figure 7

5.



Figure 8

NOT RECOMMENDED FOR NEW DESIGN

■ Standard Circuit



*1. C_{IN} is a capacitor for stabilizing the input.

*2. A tantalum capacitor (2.2 μF or more) can be used.

Figure 9

Caution The above connection diagram and constant will not guarantee successful operation. Perform thorough evaluation using the actual application to set the constant.

■ Condition of Application

Input capacitor (C_{IN}): 1.0 μF or more

Output capacitor (C_L): 2.2 μF or more (tantalum capacitor)

Caution Generally a series regulator may cause oscillation, depending on the selection of external parts. Check that no oscillation occurs with the application using the above capacitor.

NOT RECOMMENDED FOR NEW DESIGN

■ **Explanation of Terms**

1. Low dropout voltage regulator

This voltage regulator has the low dropout voltage due to its built-in low on-resistance transistor.

2. Output voltage (V_{OUT})

The accuracy of the output voltage is ensured at $\pm 1.0\%$ under the specified conditions of fixed input voltage*1, fixed output current, and fixed temperature.

*1. Differs depending the product.

Caution If the above conditions change, the output voltage value may vary and exceed the accuracy range of the output voltage. Refer to “■ Electrical Characteristics” and “■ Characteristics (Typical Data)” for details.

3. Line regulation $\left(\frac{\Delta V_{OUT1}}{\Delta V_{IN} \cdot V_{OUT}} \right)$

Indicates the dependency of the output voltage on the input voltage. That is, the value shows how much the output voltage changes due to a change in the input voltage with the output current remaining unchanged.

4. Load regulation (ΔV_{OUT2})

Indicates the dependency of the output voltage on the output current. That is, the value shows how much the output voltage changes due to a change in the output current with the input voltage remaining unchanged.

5. Dropout voltage (V_{drop})

Indicates the difference between input voltage (V_{IN1}) and the output voltage when; decreasing input voltage (V_{IN}) gradually until the output voltage has dropped out to the value of 98% of output voltage (V_{OUT3}), which is at $V_{IN} = V_{OUT(S)} + 1.0$ V.

$$V_{drop} = V_{IN1} - (V_{OUT3} \times 0.98)$$

NOT RECOMMENDED FOR NEW DESIGN

6. Output voltage temperature coefficient $\left(\frac{\Delta V_{OUT}}{\Delta T_a \cdot V_{OUT}}\right)$

The shaded area in **Figure 10** is the range where V_{OUT} varies in the operation temperature range when the output voltage temperature coefficient is ± 100 ppm/ $^{\circ}\text{C}$.

Example of S-1111/1121B28 typ. product

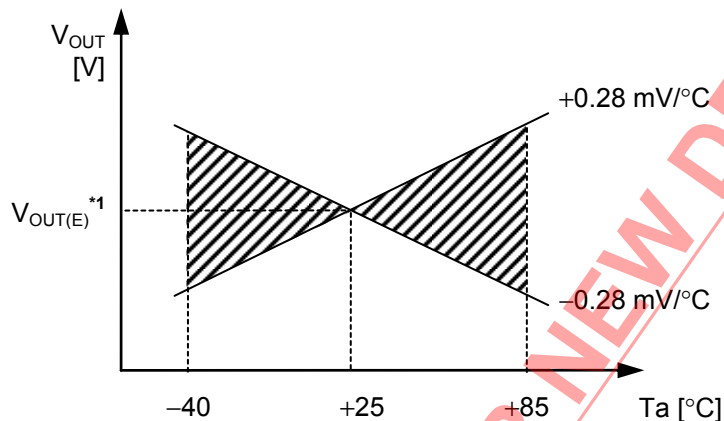

*1. $V_{OUT(E)}$ is the value of the output voltage measured at $T_a = +25^{\circ}\text{C}$.

Figure 10

A change in the temperature of the output voltage [mV/ $^{\circ}\text{C}$] is calculated using the following equation.

$$\frac{\Delta V_{OUT}}{\Delta T_a} [\text{mV/}^{\circ}\text{C}]^{*1} = V_{OUT(S)} [\text{V}]^{*2} \times \frac{\Delta V_{OUT}}{\Delta T_a \cdot V_{OUT}} [\text{ppm/}^{\circ}\text{C}]^{*3} \div 1000$$

- *1. Change in temperature of output voltage
- *2. Set output voltage
- *3. Output voltage temperature coefficient

NOT RECOMMENDED FOR NEW DESIGN

■ **Operation**

1. Basic operation

Figure 11 shows the block diagram of the S-1111/1121 Series.

The error amplifier compares the reference voltage (V_{ref}) with feedback voltage (V_{fb}), which is the output voltage resistance-divided by feedback resistors (R_s and R_f). It supplies the gate voltage necessary to maintain the constant output voltage which is not influenced by the input voltage and temperature change, to the output transistor.

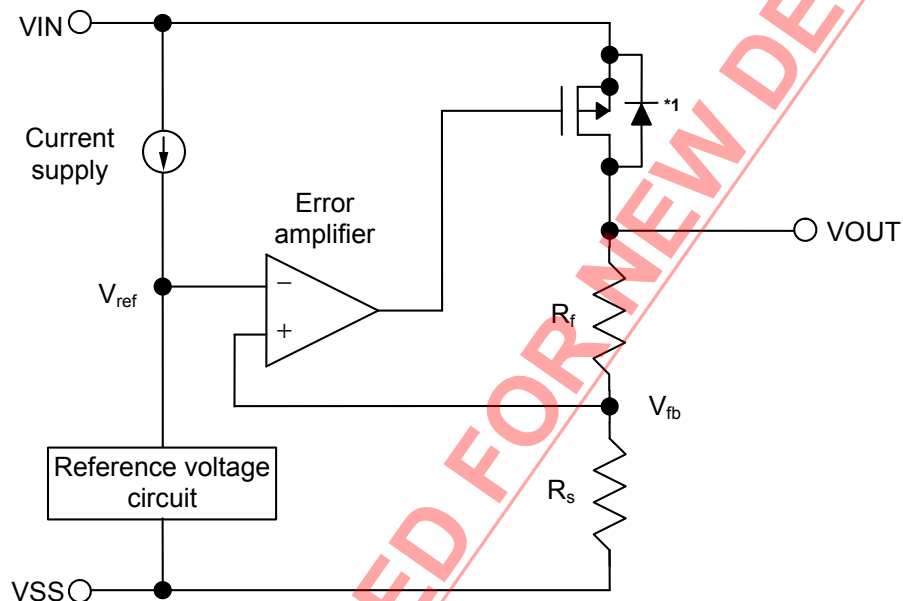

*1. Parasitic diode

Figure 11

2. Output transistor

In the S-1111/1121 Series, a low on-resistance P-channel MOS FET is used as the output transistor. Be sure that V_{OUT} does not exceed $V_{IN} + 0.3$ V to prevent the voltage regulator from being damaged due to reverse current flowing from the VOUT pin through a parasitic diode to the VIN pin, when the potential of V_{OUT} became higher than V_{IN} .

3. ON/OFF pin

This pin starts and stops the regulator.

When the ON/OFF pin is set to OFF level, the entire internal circuit stops operating, and the built-in P-channel MOS FET output transistor between the VIN pin and the VOUT pin is turned off, reducing current consumption significantly. The VOUT pin becomes the V_{SS} level due to the internally divided resistance of several hundreds kΩ between the VOUT pin and the VSS pin.

The structure of the ON/OFF pin is as shown in **Figure 12**. Since the ON/OFF pin is neither pulled down nor pulled up internally, do not use it in the floating status. In addition, note that the current consumption increases if a voltage of 0.3 V to V_{IN} - 0.3 V is applied to the ON/OFF pin. When not using the ON/OFF pin, connect it to the VSS pin in the product A type, and connect it to the VIN pin in B type.

Table 7

Product Type	ON/OFF Pin	Internal Circuit	VOUT Pin Voltage	Current Consumption
A	"L": ON	Operate	Set value	I _{SS1}
A	"H": OFF	Stop	V _{SS} level	I _{SS2}
B	"L": OFF	Stop	V _{SS} level	I _{SS2}
B	"H": ON	Operate	Set value	I _{SS1}



Figure 12

■ Selection of Output Capacitor (C_L)

The S-1111/1121 Series performs phase compensation using the internal phase compensator in the IC and the ESR (Equivalent Series Resistance) of the output capacitor to enable stable operation independent of changes in the output load. Therefore, always place a capacitor (C_L) of 2.2 μF or more between the VOUT pin and the VSS pin.

For stable operation of the S-1111/1121 Series, it is essential to employ a capacitor whose ESR is within an optimum range. Using a capacitor whose ESR is outside the optimum range (approximately 0.5 Ω to 5 Ω), whether larger or smaller, may cause an unstable output, resulting in oscillation. For this reason, a tantalum electrolytic capacitor is recommended.

When a ceramic capacitor or an OS capacitor with a low ESR is used, it is necessary to connect an additional resistor that serves as the ESR in series with the output capacitor. The required resistance value is approximately 0.5 Ω to 5 Ω, which varies depending on the usage conditions, so perform sufficient evaluation for selection. Ordinarily, around 1.0 Ω is recommended.

Note that an aluminum electrolytic capacitor may increase the ESR at a low temperature, causing oscillation. When using this kind of capacitor, perform thorough evaluation, including evaluation of temperature characteristics.

■ **Precautions**

- Wiring patterns for the VIN pin, the VOUT pin and GND should be designed so that the impedance is low. When mounting an output capacitor between the VOUT pin and the VSS pin (C_L) and a capacitor for stabilizing the input between the VIN pin and the VSS pin (C_{IN}), the distance from the capacitors to these pins should be as short as possible.
- Note that generally the output voltage may increase when a series regulator is used at low load current (1.0 mA or less).
- The S-1111/1121 Series performs phase compensation by using an internal phase compensator and the ESR of an output capacitor. Therefore, always place a capacitor of 2.2 μ F or more between the VOUT pin and the VSS pin. A tantalum type capacitor is recommended. Moreover, to secure stable operation of the S-1111/1121 Series, it is necessary to employ a capacitor with an ESR within an optimum range (0.5 Ω to 5 Ω). Using a capacitor whose ESR is outside the optimum range (approximately 0.5 Ω to 5 Ω), whether larger or smaller, may cause an unstable output, resulting in oscillation. Perform sufficient evaluation under the actual usage conditions for selection, including evaluation of temperature characteristics.
- The voltage regulator may oscillate when the impedance of the power supply is high and the input capacitance is small or an input capacitor is not connected.
- Overshoot may occur in the output voltage momentarily if the voltage is rapidly raised at power-on or when the power supply fluctuates. Sufficiently evaluate the output voltage at power-on with the actual device.
- The application conditions for the input voltage, the output voltage, and the load current should not exceed the package power dissipation.
- Do not apply an electrostatic discharge to this IC that exceeds the performance ratings of the built-in electrostatic protection circuit.
- In determining the output current, attention should be paid to the output current value specified in **Table 6** in “■ **Electrical Characteristics**” and footnote *5 of the table.
- SII claims no responsibility for any disputes arising out of or in connection with any infringement by products including this IC of patents owned by a third party.

NOT RECOMMENDED FOR NEW DESIGN

■ Characteristics (Typical Data)

Remark The following, which describes the S-1111 Series as the typical product, shows typical data common to the S-1121 Series.

(1) Output Voltage vs. Output current (when load current increases)

S-1111B15 (Ta = 25 °C)



S-1111B30 (Ta = 25 °C)



S-1111B50 (Ta = 25 °C)



Remark In determining the output current, attention should be paid to the following.

- 1) The minimum output current value and footnote *5 of Table 6 in the "■ Electrical Characteristics"
- 2) The package power dissipation

(2) Output voltage vs. Input voltage

S-1111B15 (Ta = 25 °C)

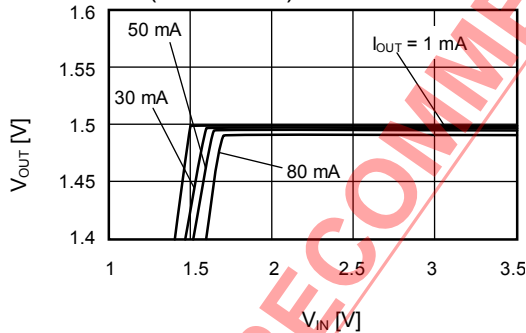

S-1111B30 (Ta = 25 °C)

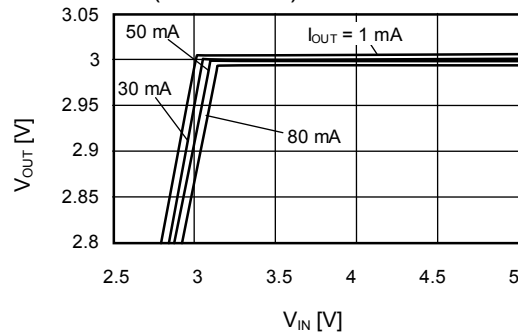

S-1111B50 (Ta = 25 °C)

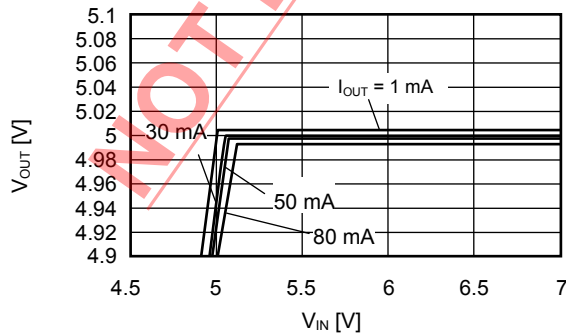

(3) Dropout voltage vs. Output current

S-1111B15

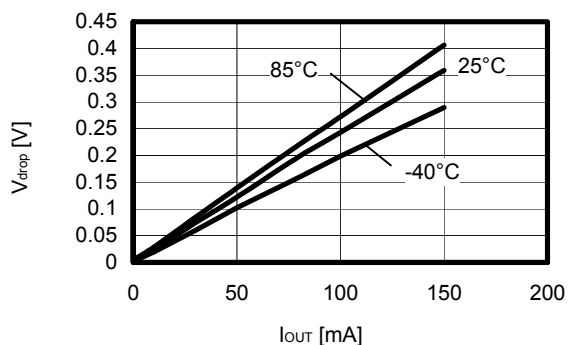

S-1111B30

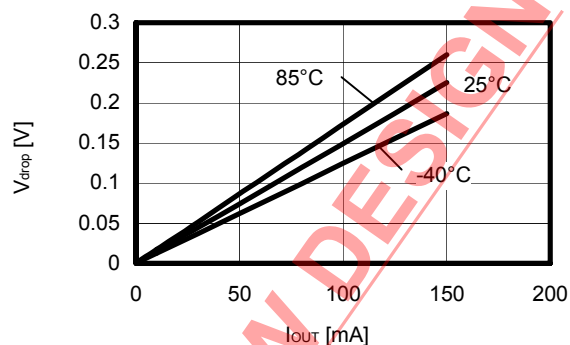

S-1111B50



(4) Dropout voltage vs. Set output voltage



NOT RECOMMENDED FOR NEW DESIGN

(5) Output voltage vs. Ambient temperature

S-1111B15



S-1111B30



S-1111B50



(6) Current consumption vs. Input voltage

S-1111B15

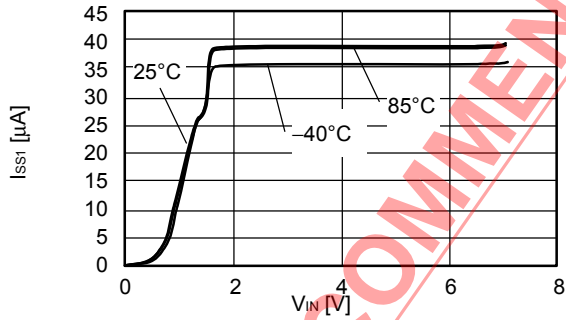

S-1111B30

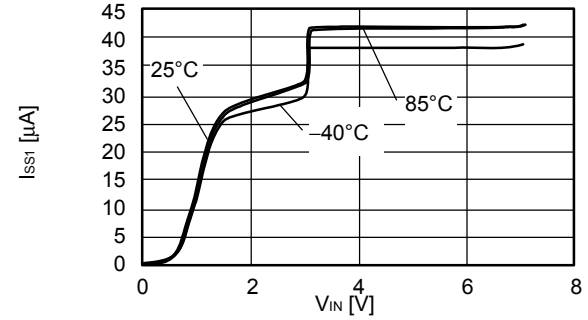

S-1111B50

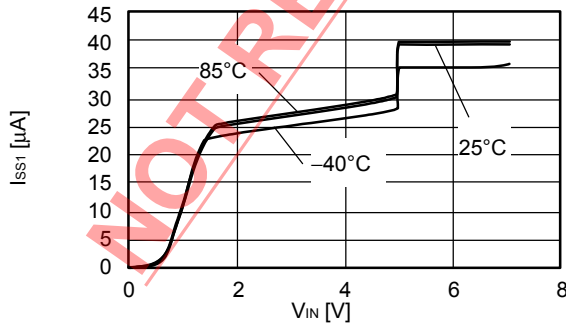

(7) Ripple rejection

S-1111B15 ($T_a = 25\text{ }^\circ\text{C}$)
 $V_{IN} = 2.5\text{ V}$, $C_{OUT} = 2.2\text{ }\mu\text{F}$



S-1111B30 ($T_a = 25\text{ }^\circ\text{C}$)
 $V_{IN} = 4.0\text{ V}$, $C_{OUT} = 2.2\text{ }\mu\text{F}$



S-1111B50 ($T_a = 25\text{ }^\circ\text{C}$)
 $V_{IN} = 6.0\text{ V}$, $C_{OUT} = 2.2\text{ }\mu\text{F}$

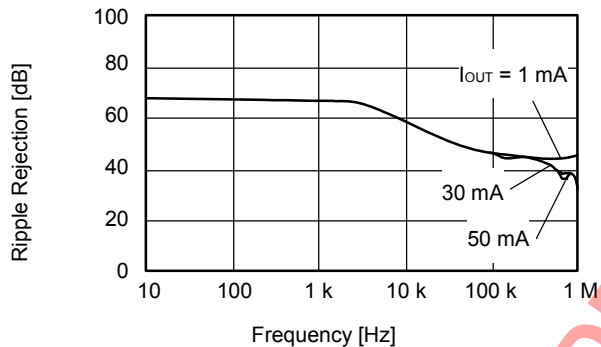

NOT RECOMMENDED FOR NEW DESIGN

■ Reference Data

(1) Input transient response characteristics

$I_{OUT} = 30\text{ mA}$, $t_r = t_f = 5.0\ \mu\text{s}$, $C_{OUT} = 2.2\ \mu\text{F}$, $C_{IN} = 0\ \mu\text{F}$

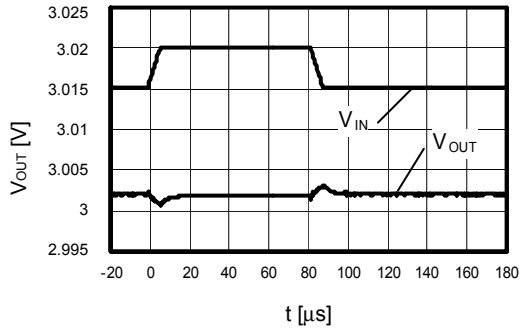

$I_{OUT} = 30\text{ mA}$, $t_r = t_f = 5.0\ \mu\text{s}$, $C_{OUT} = 4.7\ \mu\text{F}$, $C_{IN} = 0\ \mu\text{F}$

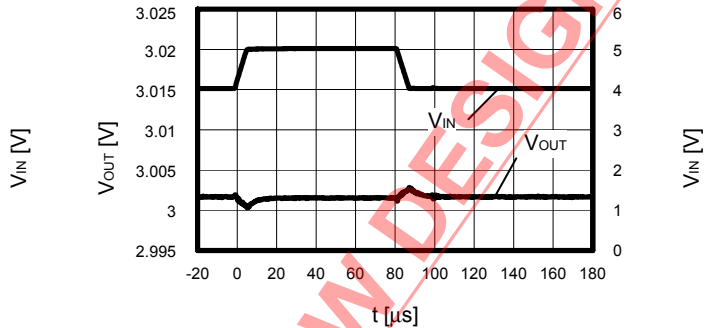

(2) Load transient response characteristics

$V_{IN} = 4.0\text{ V}$, $C_{OUT} = 2.2\ \mu\text{F}$, $C_{IN} = 1.0\ \mu\text{F}$,
 $I_{OUT} = 50\text{ mA} \leftrightarrow 100\text{ mA}$

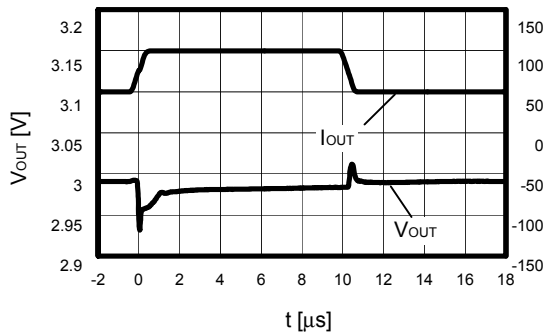

$V_{IN} = 4.0\text{ V}$, $C_{OUT} = 4.7\ \mu\text{F}$, $C_{IN} = 1.0\ \mu\text{F}$,
 $I_{OUT} = 50\text{ mA} \leftrightarrow 100\text{ mA}$

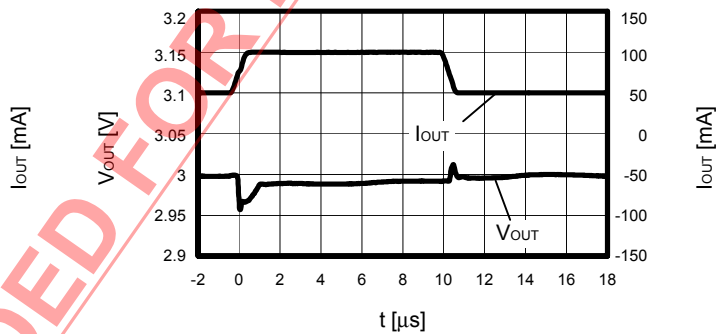

(3) ON/OFF pin transient response characteristics

S-1111B15 ($T_a = 25\text{ }^\circ\text{C}$)

$V_{IN} = 2.5\text{ V}$, $C_{OUT} = 2.2\ \mu\text{F}$, $C_{IN} = 1.0\ \mu\text{F}$

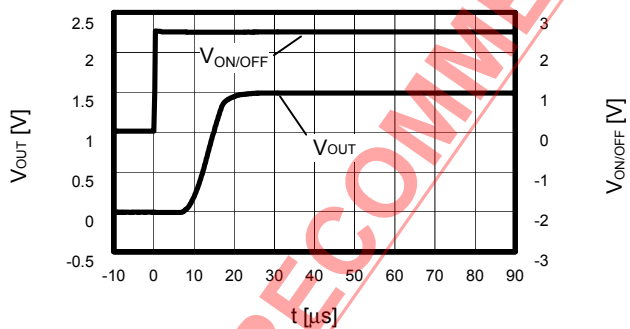

S-1111B30 ($T_a = 25\text{ }^\circ\text{C}$)

$V_{IN} = 4.0\text{ V}$, $C_{OUT} = 2.2\ \mu\text{F}$, $C_{IN} = 1.0\ \mu\text{F}$

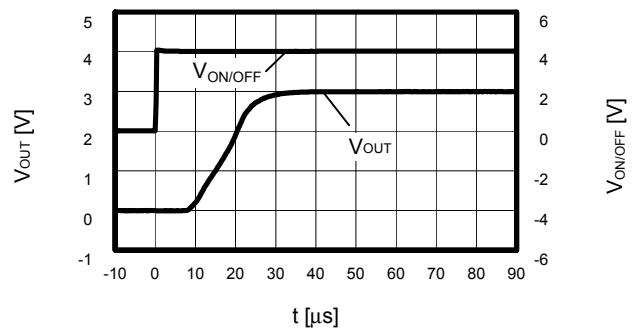

S-1111B50 ($T_a = 25\text{ }^\circ\text{C}$)

$V_{IN} = 6.0\text{ V}$, $C_{OUT} = 2.2\ \mu\text{F}$, $C_{IN} = 1.0\ \mu\text{F}$

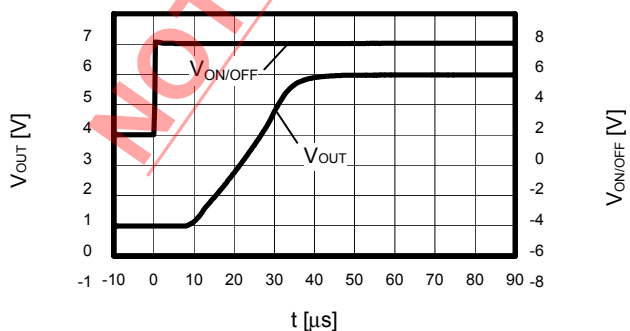

NOT RECOMMENDED FOR NEW DESIGN



No. MP005-A-P-SD-1.2

TITLE	SOT235-A-PKG Dimensions
No.	MP005-A-P-SD-1.2
SCALE	
UNIT	mm
Seiko Instruments Inc.	



→
Feed direction

No. MP005-A-C-SD-2.1

TITLE	SOT235-A-Carrier Tape
No.	MP005-A-C-SD-2.1
SCALE	
UNIT	mm
Seiko Instruments Inc.	



Enlarged drawing in the central part



No. MP005-A-R-SD-1.1

TITLE	SOT235-A-Reel		
No.	MP005-A-R-SD-1.1		
SCALE		QTY.	3,000
UNIT	mm		
Seiko Instruments Inc.			



Seiko Instruments Inc.
www.sii-ic.com

- The information described herein is subject to change without notice.
- Seiko Instruments Inc. is not responsible for any problems caused by circuits or diagrams described herein whose related industrial properties, patents, or other rights belong to third parties. The application circuit examples explain typical applications of the products, and do not guarantee the success of any specific mass-production design.
- When the products described herein are regulated products subject to the Wassenaar Arrangement or other agreements, they may not be exported without authorization from the appropriate governmental authority.
- Use of the information described herein for other purposes and/or reproduction or copying without the express permission of Seiko Instruments Inc. is strictly prohibited.
- The products described herein cannot be used as part of any device or equipment affecting the human body, such as exercise equipment, medical equipment, security systems, gas equipment, vehicle equipment, in-vehicle equipment, aviation equipment, aerospace equipment, and nuclear-related equipment, without prior written permission of Seiko Instruments Inc.
- The products described herein are not designed to be radiation-proof.
- Although Seiko Instruments Inc. exerts the greatest possible effort to ensure high quality and reliability, the failure or malfunction of semiconductor products may occur. The user of these products should therefore give thorough consideration to safety design, including redundancy, fire-prevention measures, and malfunction prevention, to prevent any accidents, fires, or community damage that may ensue.

Mouser Electronics

Authorized Distributor

Click to View Pricing, Inventory, Delivery & Lifecycle Information:

ABLIC:

[S-1121B18MC-N2DTFG](#) [S-1111B18MC-NYDTFG](#) [S-1121B26MC-N2LTFG](#) [S-1121B33MC-N2STFG](#) [S-1121B27MC-N2MTFG](#) [S-1111B33MC-NYSTFG](#) [S-1111B27MC-NYMTFG](#) [S-1111B30MC-NYPTFG](#) [S-1121B30MC-N2PTFG](#) [S-1111B28MC-NYNTFG](#) [S-1111B25MC-NYKTFG](#) [S-1111B15MC-NYATFG](#) [S-1121B25MC-N2KTFG](#) [S-1121B15MC-N2ATFG](#) [S-1121B29MC-N2OTFG](#) [S-1111B29MC-NYOTFG](#) [S-1121B50MC-N3JTFG](#) [S-1111B50MC-NZJTFG](#) [S-1111B31MC-NYQTFG](#) [S-1121B31MC-N2QTFG](#) [S-1121B28MC-N2NTFG](#) [S-1111B26MC-NYLTFG](#) [S-1111B16MC-NYBTFG](#) [S-1111B17MC-NYCTFG](#) [S-1111B19MC-NYETFG](#) [S-1111B20MC-NYFTFG](#) [S-1111B21MC-NYGTFG](#) [S-1111B22MC-NYHTFG](#) [S-1111B23MC-NYITFG](#) [S-1111B24MC-NYJTFG](#) [S-1111B34MC-NYTTFG](#) [S-1111B35MC-NYUTFG](#) [S-1111B36MC-NYVTFG](#) [S-1111B37MC-NYWTFG](#) [S-1111B38MC-NYXTFG](#) [S-1111B39MC-NYYTFG](#) [S-1111B40MC-NYZTFG](#) [S-1111B41MC-NZATFG](#) [S-1111B42MC-NZBTFG](#) [S-1111B43MC-NZCTFG](#) [S-1111B44MC-NZDTFG](#) [S-1111B45MC-NZETFG](#) [S-1111B46MC-NZFTFG](#) [S-1111B47MC-NZGTFG](#) [S-1111B48MC-NZHTFG](#) [S-1111B49MC-NZITFG](#) [S-1111B51MC-NZKTFG](#) [S-1111B52MC-NZLTFG](#) [S-1111B53MC-NZMTFG](#) [S-1111B54MC-NZNFTG](#) [S-1111B55MC-NZOTFG](#) [S-1121B16MC-N2BTFG](#) [S-1121B17MC-N2CTFG](#) [S-1121B19MC-N2ETFG](#) [S-1121B20MC-N2FTFG](#) [S-1121B21MC-N2GTFG](#) [S-1121B22MC-N2HTFG](#) [S-1121B23MC-N2ITFG](#) [S-1121B24MC-N2JTFG](#) [S-1121B32MC-N2RTFG](#) [S-1121B34MC-N2TTFG](#) [S-1121B35MC-N2UTFG](#) [S-1121B36MC-N2VTFG](#) [S-1121B37MC-N2WTFG](#) [S-1121B38MC-N2XTFG](#) [S-1121B39MC-N2YTFG](#) [S-1121B40MC-N2ZTFG](#) [S-1121B41MC-N3ATFG](#) [S-1121B42MC-N3BTFG](#) [S-1121B43MC-N3CTFG](#) [S-1121B44MC-N3DTFG](#) [S-1121B45MC-N3ETFG](#) [S-1121B46MC-N3FTFG](#) [S-1121B47MC-N3GTFG](#) [S-1121B48MC-N3HTFG](#) [S-1121B49MC-N3ITFG](#) [S-1121B4HMC-N3PTFG](#) [S-1121B51MC-N3KTFG](#) [S-1121B52MC-N3LTFG](#) [S-1121B53MC-N3MTFG](#) [S-1121B54MC-N3NTFG](#) [S-1121B55MC-N3OTFG](#) [S-1111B32MC-NYRTFU](#)

Компания «Океан Электроники» предлагает заключение долгосрочных отношений при поставках импортных электронных компонентов на взаимовыгодных условиях!

Наши преимущества:

- Поставка оригинальных импортных электронных компонентов напрямую с производств Америки, Европы и Азии, а так же с крупнейших складов мира;
- Широкая линейка поставок активных и пассивных импортных электронных компонентов (более 30 млн. наименований);
- Поставка сложных, дефицитных, либо снятых с производства позиций;
- Оперативные сроки поставки под заказ (от 5 рабочих дней);
- Экспресс доставка в любую точку России;
- Помощь Конструкторского Отдела и консультации квалифицированных инженеров;
- Техническая поддержка проекта, помощь в подборе аналогов, поставка прототипов;
- Поставка электронных компонентов под контролем ВП;
- Система менеджмента качества сертифицирована по Международному стандарту ISO 9001;
- При необходимости вся продукция военного и аэрокосмического назначения проходит испытания и сертификацию в лаборатории (по согласованию с заказчиком);
- Поставка специализированных компонентов военного и аэрокосмического уровня качества (Xilinx, Altera, Analog Devices, Intersil, Interpoint, Microsemi, Actel, Aeroflex, Peregrine, VPT, Syfer, Eurofarad, Texas Instruments, MS Kennedy, Miteq, Cobham, E2V, MA-COM, Hittite, Mini-Circuits, General Dynamics и др.);

Компания «Океан Электроники» является официальным дистрибьютором и эксклюзивным представителем в России одного из крупнейших производителей разъемов военного и аэрокосмического назначения «JONHON», а так же официальным дистрибьютором и эксклюзивным представителем в России производителя высокотехнологичных и надежных решений для передачи СВЧ сигналов «FORSTAR».



JONHON

«JONHON» (основан в 1970 г.)

Разъемы специального, военного и аэрокосмического назначения:

(Применяются в военной, авиационной, аэрокосмической, морской, железнодорожной, горно- и нефтедобывающей отраслях промышленности)

«FORSTAR» (основан в 1998 г.)

ВЧ соединители, коаксиальные кабели, кабельные сборки и микроволновые компоненты:

(Применяются в телекоммуникациях гражданского и специального назначения, в средствах связи, РЛС, а так же военной, авиационной и аэрокосмической отраслях промышленности).



Телефон: 8 (812) 309-75-97 (многоканальный)

Факс: 8 (812) 320-03-32

Электронная почта: ocean@oceanchips.ru

Web: <http://oceanchips.ru/>

Адрес: 198099, г. Санкт-Петербург, ул. Калинина, д. 2, корп. 4, лит. А