



EAO Product Information

Series 22



Description	3
Product Assembly	4
Devices raised mounting	5
Accessories.....	9
Technical Data.....	13
Marking	14
Drawings.....	15
Index.....	19

Product Information

General notes

The illuminated pushbuttons, keylock switches, mushroom pushbuttons with momentary or maintained action and indicators are primarily noteworthy for their degree of protection IP 65 of the front (i.e. dust and splash-proof). Their robust, compact design, mounting by one man, their screw and plug-in terminals proof against inadvertent contact, and their large surface area for engraving and illumination are other quality features.

The switching element is a double-break snap-action system, the current being carried by a through-contact bar.

The dimensions of the front bezel are 24 x 36 mm. For indicators and illuminated pushbuttons you can choose the design of the front to suit your requirements from two front bezels which clip on in different ways. The raised front bezel of keylock switches is fixed Typ-Nr. 02-967.0.

Mounting

Mounting by one man from the front. The switch, pushed into the square opening in the panel from the front, can be fixed with two clamping elements (tighten screws with max. 30 Ncm).

Lenses

The flat lenses, made of Polymethyl Methacrylate, are obtainable in various colours, as well as transparent or translucent.

The lens has to be fitted in the unactuated position.

Marking

For further information about engraving, hot stamping and film inserts see part Marking.

Illumination

The T1 ³/₄ Midget Groove incandescent (filament) lamp (6 ... 48 V) ensures perfect illumination of the lenses, which are supplied in various colours.

T1 ³/₄ Midget Groove Single-LED (6, 12, 24, 28, 48 V) are also available in blue, green, red, white or yellow.

Luminosity and wave length scattering caused by the technology used in the LED manufacturing processes may lead to visual differences in our products.

For supply voltages above 48 V, it is necessary to use a voltage reduction element (external series resistor or transformer).

Position indication

The status of a maintained action switch can be determined by the position of the lens.

Keylock switch

Standard lock (Index D). Standard lock number is 311. If the lock number is not specified, we will supply standard number 311.

An additional 134 special locks (Index X) are available on request.

Master keys for lock numbers 311 ... 445 may be ordered by quoting Typ-Nr. 31-989.300. Two keys are supplied with each keylock switch.

Spare keys (Index D) for standard locks may be ordered by quoting Typ-Nr. 31-989.xxx (please state the lock number).

Number structure

Nomenclature in accordance with ' IEC 61058 TEST REPORT '. The certification document we dispatch to them on demands.

Specimen order

Indicator :

- Indicator actuator, 24 x 36 mm, screw terminal 22-040.004

Essential accessories :

- Lens plastic red, transparent 22-903.2
- Front bezel flush, black 22-965.0
- Single-LED, T1 ³/₄ MG, 24 VAC/DC, red 10-2J12.1062

We reserve the right to modify technical data

All dimensions in mm

Pushbutton illuminative, raised mounting

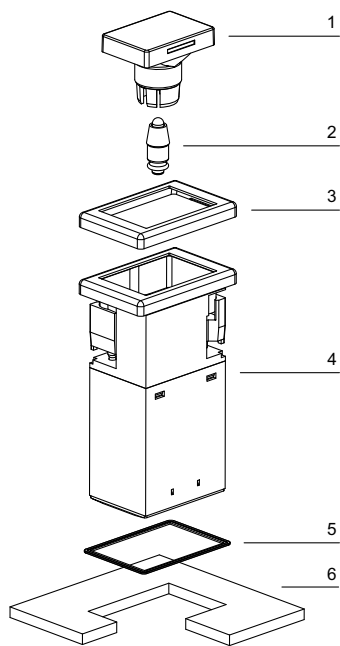



- 1 Lens
- 2 LED
- 3 Front bezel clip-on
- 4 Switch housing
- 5 Sealing
- 6 Front plate

Indicator actuator



Essential Accessories:

-  Front bezel flush page 9
-  Lens plastic page 9
-  Single-LED page 11

	Front protection	Terminals	□ 24 x 36 mm Typ-Nr.	Mounting dimensions	Technical drawing	Circuit drawing	
Indicator actuator	IP 65	PT 6.3	22-040.004	1	2	1	0.019
		ST	22-040.001	1	2	1	0.022



Terminals: PT 6.3 = Plug-in terminal 6.3 mm, ST = Screw terminal

Mounting dimensions from page 15, Technical drawing from page 15, Circuit drawing from page 16

Illuminated pushbutton actuator



Essential Accessories:

-  Front bezel flush page 9
-  Lens plastic page 9
-  Single-LED page 11

	Front protection	Switching system	Contacts	Switching action	Terminals	□ 24 x 36 mm Typ-Nr.	Mounting dimensions	Technical drawing	Circuit drawing		
Illuminated pushbutton actuator	IP 65	SA	1 NC	MA	PT 6.3	22-222.014	1	6	3	0.032	
					ST	22-222.011	1	3	3	0.037	
				M	PT 6.3	22-212.014	1	3	8	0.032	
					ST	22-212.011	1	3	8	0.037	
				1 NC + 1 NO	MA	PT 6.3	22-225.014	1	3	5	0.034
						ST	22-225.011	1	3	5	0.044
			M		PT 6.3	22-215.014	1	3	10	0.034	
				ST	22-215.011	1	3	10	0.044		
			1 NO	MA	PT 6.3	22-221.014	1	3	4	0.032	
					ST	22-221.011	1	3	4	0.037	
				M	PT 6.3	22-211.014	1	3	9	0.032	
					ST	22-211.011	1	3	9	0.037	
			2 NC	MA	PT 6.3	22-224.014	1	3	2	0.034	
					ST	22-224.011	1	3	2	0.044	
				M	PT 6.3	22-214.014	1	3	7	0.034	
					ST	22-214.011	1	3	7	0.044	
			2 NO	MA	PT 6.3	22-223.014	1	3	6	0.044	
					ST	22-223.011	1	3	6	0.044	
				M	PT 6.3	22-213.014	1	3	11	0.034	
					ST	22-213.011	1	3	11	0.044	

Switching system: SA = Snap-action switching element

Contacts: NC = Normally closed, NO = Normally open

Switching action: MA = Maintained action, M = Momentary action



Terminals: PT 6.3 = Plug-in terminal 6.3 mm, ST = Screw terminal

Mounting dimensions from page 15, Technical drawing from page 15, Circuit drawing from page 16

Mushroom-head pushbutton actuator



Essential Accessories:

-  Front bezel flush page 9
-  Mushroom-head cap page 9

	Switching system	Contacts	Switching action	Terminals	□ 24 x 36 mm Typ-Nr.	Mounting dimensions	Technical drawing	Circuit drawing	
Mushroom-head pushbutton actuator	SA	1 NC	MA	PT 6.3	22-222.014	1 4 3	0.032		
				ST	22-222.011	1 4 3	0.037		
			M	PT 6.3	22-212.014	1 4 8	0.032		
				ST	22-212.011	1 4 8	0.037		
		1 NC + 1 NO	MA	PT 6.3	22-225.014	1 4 5	0.034		
				ST	22-225.011	1 4 5	0.044		
			M	PT 6.3	22-215.014	1 4 10	0.034		
				ST	22-215.011	1 4 10	0.044		
		1 NO	MA	PT 6.3	22-221.014	1 4 4	0.032		
				ST	22-221.011	1 4 4	0.037		
			M	PT 6.3	22-211.014	1 4 9	0.032		
				ST	22-211.011	1 4 9	0.037		
		2 NC	MA	PT 6.3	22-224.014	1 4 2	0.034		
				ST	22-224.011	1 4 2	0.044		
			M	PT 6.3	22-214.014	1 4 7	0.034		
				ST	22-214.011	1 4 7	0.044		
		2 NO	MA	PT 6.3	22-223.014	1 4 6	0.044		
				ST	22-223.011	1 4 6	0.044		
			M	PT 6.3	22-213.014	1 4 11	0.034		
				ST	22-213.011	1 4 11	0.044		

Switching system: SA = Snap-action switching element

Contacts: NC = Normally closed, NO = Normally open

Switching action: MA = Maintained action, M = Momentary action

Terminals: PT 6.3 = Plug-in terminal 6.3 mm, ST = Screw terminal

Mounting dimensions from page 15, Technical drawing from page 15, Circuit drawing from page 16

Keylock switch 2 positions

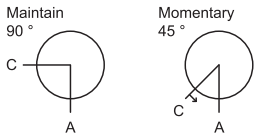

	Front protection	Switching system	Contacts	Switching action	Terminals	Key remove	□ 24 x 36 mm Typ-Nr.	Mounting dimensions	Technical drawing	Circuit drawing	(E)	
Keylock switch 2 positions Position A : Basic position Position C : Maintained action Standard lock 311 Front : Plastic black	IP 65	SA	1 NC + 1 NO	MA	PT 6.3	A	22-335.114D	1	5	16	0.046	
						C	22-335.314D	1	5	16	0.046	
						C + A	22-335.514D	1	5	16	0.046	
					ST	A	22-335.111D	1	5	16	0.051	
						C	22-335.311D	1	5	16	0.051	
						C + A	22-335.511D	1	5	16	0.051	
				1 NO	MA	PT 6.3	A	22-331.114D	1	5	15	0.046
							C	22-331.314D	1	5	15	0.044
							C + A	22-331.514D	1	5	15	0.040
			ST		A	22-331.111D	1	5	15	0.051		
					C	22-331.311D	1	5	15	0.044		
					C + A	22-331.511D	1	5	15	0.044		
			2 NO	MA	PT 6.3	A	22-333.114D	1	5	17	0.046	
						C	22-333.314D	1	5	17	0.046	
						C + A	22-333.514D	1	5	17	0.046	
ST	A	22-333.111D		1	5	17	0.051					
	C	22-333.311D		1	5	17	0.051					
	C + A	22-333.511D		1	5	17	0.051					
Position A : Basic position Position C : Momentary action Standard lock 311 Front : Plastic black	IP 65	SA	1 NC + 1 NO	M	PT 6.3	A	22-355.114D	1	5	13	0.046	
						ST	A	22-355.111D	1	5	13	0.051
						1 NO	PT 6.3	A	22-351.114D	1	5	12
			ST		A			22-351.111D	1	5	12	0.051
			2 NO		PT 6.3			A	22-353.114D	1	5	14
						ST	A	22-353.111D	1	5	14	0.051

Other lock numbers on request

Switching system: SA = Snap-action switching element

Contacts: NC = Normally closed, NO = Normally open

Switching action: MA = Maintained action, M = Momentary action

Terminals: PT 6.3 = Plug-in terminal 6.3 mm, ST = Screw terminal

Mounting dimensions from page 15, Technical drawing from page 15, Circuit drawing from page 16

Front

Lens plastic

	Lens	□ 24 x 36 mm Typ-Nr.	
Lens plastic illuminative	blue transparent	22-903.6	0.003
	colourless transparent	22-903.7	0.003
	green transparent	22-903.5	0.003
	orange transparent	22-903.3	0.003
	red transparent	22-903.2	0.003
	smoked transparent	22-903.1	0.003
	yellow transparent	22-903.4	0.003
illuminative (not recommended for film insert)	colourless transparent	22-905.7	0.003
	green transparent	22-905.5	0.003
	red transparent	22-905.2	0.003
illuminative (not recommended for film insert, bright LED's are visible)	yellow transparent	22-905.4	0.003
	blue translucent	22-901.6	0.003
	green translucent	22-901.5	0.003
	orange translucent	22-901.3	0.003
	red translucent	22-901.2	0.003
non-illuminative	white translucent	22-901.9	0.003
	yellow translucent	22-901.4	0.003
	black opaque	22-901.0	0.003
	grey opaque	22-901.8	0.003



Mushroom-head cap

use Front bezel flush

	Mushroom had cap	□ 24 x 36 mm Typ-Nr.	
Mushroom-head cap non-illuminative	Plastic black opaque	22-930.0	0.006
	Plastic green opaque	22-930.5	0.006
	Plastic red opaque	22-930.2	0.006
	Plastic yellow opaque	22-930.4	0.006



Front bezel flush

	Front bezel	□ 24 x 36 mm Typ-Nr.	
Front bezel flush	Plastic black	02-965.0	0.001



Front bezel raised

Lens only removable with lens remover 98-969

	Front bezel	□ 24 x 36 mm Typ-Nr.	
Front bezel raised	Plastic black	02-967.0	0.001



Protective cover

use Front bezel flush

		Technical drawing	
	⌀ 24 x 36 mm Typ-Nr.		
Protective cover hinged, transparent, with means for sealing	22-925	1	0.004



Technical drawing from page 15

Blind plug

		Technical drawing	
	⌀ 24 x 36 mm Typ-Nr.		
Blind plug Mounting hole size 16 mm dia.	Blind plug Plastic black	22-949.0	0.005



Master key

	Typ-Nr.	
		
Master key Lock numbers 311 ... 445 (DOM)	31-989.300	0.006



Spare key

	Typ-Nr.	
		
Spare key Key lock switch, standard lock 311 (DOM)	31-989.311	0.006



Other lock numbers on request

Illumination

Filament lamp

	Socket	Operating voltage/-current	Typ-Nr.	
Filament lamp	T1 3/4 MG	12 VAC/DC, 75 mA	10-1309.1309	0.001
		14 VAC/DC, 80 mA	10-1310.1319	0.001
		18 VAC/DC, 40 mA	10-1311.1249	0.001
		24 VAC/DC, 35 mA	10-1312.1229	0.001
		28 VAC/DC, 30 mA	10-1313.1209	0.001
		28 VAC/DC, 40 mA	10-1313.1249	0.001
		36 VAC/DC, 20 mA	10-1316.1179	0.001
		36 VAC/DC, 30 mA	10-1316.1209	0.001
		48 VAC/DC, 20 mA	10-1319.1179	0.001
		48 VAC/DC, 25 mA	10-1319.1199	0.001
		6 VAC/DC, 120 mA	10-1306.1349	0.001
		6.3 VAC/DC, 200 mA	10-1307.1369	0.001



Single-LED

	Socket	Light colour	Operating voltage/-current	Typ-Nr.	
Single-LED	T1 3/4 MG	blue	12 VAC/DC, 7/14 mA	10-2J09.1066	0.002
			24 VAC/DC, 7/14 mA	10-2J12.1066	0.002
			28 VAC/DC, 7/14 mA	10-2J13.1066	0.002
			48 VAC/DC, 4/8 mA	10-2J19.1046	0.002
			6 VDC, 15 mA	10-2J06.3146	0.002
		green	12 VAC/DC, 4/7 mA	10-2J09.1065	0.002
			24 VAC/DC, 4/7 mA	10-2J12.1065	0.002
			28 VAC/DC, 4/7 mA	10-2J13.1065	0.002
			48 VAC/DC, 2/4 mA	10-2J19.1045	0.002
			6 VDC, 7 mA	10-2J06.3145	0.002
		red	12 VAC/DC, 7/14 mA	10-2J09.1062	0.002
			24 VAC/DC, 7/14 mA	10-2J12.1062	0.002
			28 VAC/DC, 7/14 mA	10-2J13.1062	0.002
			48 VAC/DC, 4/8 mA	10-2J19.1042	0.002
			6 VDC, 15 mA	10-2J06.3142	0.002
		white diffuse	12 VAC/DC, 7/14 mA	10-2J09.1069	0.002
			24 VAC/DC, 7/14 mA	10-2J12.1069	0.002
			28 VAC/DC, 7/14 mA	10-2J13.1069	0.002
			48 VAC/DC, 4/8 mA	10-2J19.1049	0.002
			6 VDC, 15 mA	10-2J06.3149	0.002
		yellow	12 VAC/DC, 7/14 mA	10-2J09.1064	0.002
			24 VAC/DC, 7/14 mA	10-2J12.1064	0.002
			28 VAC/DC, 7/14 mA	10-2J13.1064	0.002
			48 VAC/DC, 4/8 mA	10-2J19.1044	0.002
			6 VDC, 15 mA	10-2J06.3144	0.002



Note:
AC operation through halve-wave rectifier possible, slight flickering can occur.

Series resistor

for lamp voltage reduction

	Operation voltage	Typ-Nr.	
Series resistor 10 kΩ, for filament lamp 48 VAC, 25 mA	230/240 V	02-904.7	0.003
2.7 kΩ, for filament lamp 48 VAC, 25 mA	110 V	02-904.0	0.003
3.3 kΩ, for filament lamp 48 VAC, 25 mA	125 V	02-904.1	0.003
4.7 kΩ, for filament lamp 48 VAC, 25 mA	145 V	02-904.3	0.003



Please keep to the country specific security rules.

Terminal plate empty

for fitting with series resistors

	Typ-Nr.	
Terminal plate empty 10 spaces 125 x 60 x 15 mm	02-912.2	0.045
15 spaces 187.5 x 60 x 15 mm	02-912.3	0.090
20 spaces 250 x 60 x 15 mm	02-912.4	0.095
5 spaces 62.5 x 60 x 15 mm	02-912.1	0.025



Assembling

Lens remover

	Typ-Nr.	
Lens remover for flush front bezel	02-905	0.011
for raised front bezel	98-968	0.004



Lamp remover

	Typ-Nr.	
Lamp remover	61-9740.0	0.003



CAUTION

A switching process might be released when replacing the lamp/LED !

Dismantling tool

for dismantling the lens from the holder

	Typ-Nr.	
Dismantling tool	22-938	0.030



Actuator with snap-action switching element

Switching system

Self-cleaning, double-break, snap-action switching system (with contact gap 2 x 1.5 mm).
Max. 2 normally closed or 2 normally open contacts, or one of each.

Material

Lens

Polymethylmethacrylate PMMA, as per UL 94 HB, Polycarbonate (PC), as per UL 94 V0

Front bezel

Polyphenylenoxide (PPO)

Material of contact

Hard silver

Actuator housing

Polyamide (PA), Polytherimide (PEI)

Mechanical characteristics

Terminals

Screw terminal (with self-lifting clip):
Max. wire cross-section 2 x 2.5 mm²
Max. wire cross-section of stranded cable 2 x 1.5 mm²

Plug-in terminal 6.3 x 0.8 mm

Actuating force

with 1 switching element 3.6 N ±0.3 N
with 2 switching elements 6.8 N ±0.3 N

Actuating travel

5.5 mm ±0.2 mm

Travel

3 mm

Rebound time

≤3 ms

Mechanical lifetime

Illuminated pushbutton 1 million operations
Keylock switch 40 000 operations

Electrical characteristics

Contact resistance

Starting value ≤50 mΩ, as per IEC 60512-2-4

Isolation resistance

≥100M Ω between all contacts at 100 VDC, as per IEC 60512-2-10

Switch rating

Power rating
min. 12 VAC, 50 mA
max. 400 VAC, 10 A

Switch rating AC (cosφ 0,7), service category AC-11

Voltage	125 VAC	250 VAC	380 VAC
Current	8 A	5 A	3 A
Operations	≥100 000		

Switch rating DC (inductive) L:R = 30 ms, service categorie DC-11

Voltage	24 V	60 V	110 V	220 V
Current	6 A	1.5 A	0.4 A	0.2 A
Operations	≥100 000			

Electric strength

2500 VAC, 50 Hz, 1 min. between all terminals and earth, as per IEC 60512-2-11.

Environmental conditions

Storage temperature

-40 °C ... +95 °C

Service temperature

-25 °C ... +85 °C

Protection degree

Terminal/case IP 20
Front IP 65 as per IEC 60529

Shock resistance

50 g for 11 ms, as per IEC 60512-4-3

Vibration resistance

(sinusoidal)
10 g at 10 Hz ... 2000 Hz, amplitude 0.75 mm, as per IEC 60512-4-4

Approvals

Approbations

CB (IEC 61058)
CSA
ENEC (EN 61058)
UL
VDE

Declaration of conformity

CE
RoHS

General notes

1. Engraving

In addition to the most commonly used world languages, in DIN 1451-3 close spacing, other typefaces are available as Scandinavian, Slavic, Greek, Russian and Polish.

Red, blue and black lenses are filled with white colour. Other colour lenses are filled in black. Standard height of letters is 3 mm. If the height is not specified, we will supply 3 mm engraved letters.

2. Hot stamping

For larger series it is worth considering markings by means of hot stamping. We will be pleased to advise you.

For letters and figures, typefaces with 2.5 mm, 3 mm and 4 mm are available.

3. Film inserts

Instead of using engraving the lenses can be fitted with transparent film inserts, as an alternative. For this purpose, though, it is advisable to use transparent lenses.

In the case of use of a smoke-black lens the fitted film becomes readable only if the lamp is on.

The film thickness is 0.2 mm.

Important : Consider pushbutton mounting orientation before specifying engraving characters !

All dimensions in mm

Film insert max. size	Height of letters h	Number of lines	Number of (target value) capital letters per line	Number of (target value) small letters per line	Image
14.3 x 22.4	3	4	11	13	B1
			7 - 8	8 - 9	B2
	4	2	7	9	B1
			4	5	5 - 6
	5	2	5 - 6	6 - 7	B1
			3	3 - 4	4
	6	1	5	6	B1
			2	3	4
	8	1	3	4	B1
			2	2	B2

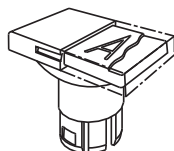
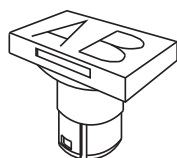

B1

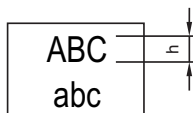

B2

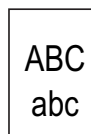

Mounting dimensions

1 Indicator actuator page 5 | Illuminated pushbutton actuator page 6 | Mushroom-head pushbutton actuator page 7 | Keylock switch 2 positions page 8

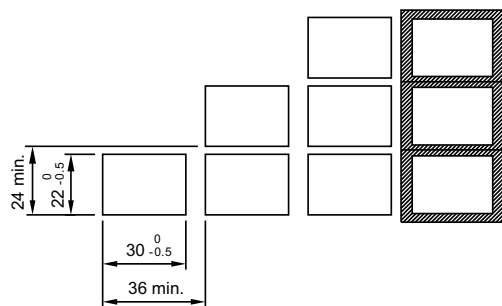

Technical drawing

1 Protective cover page 10

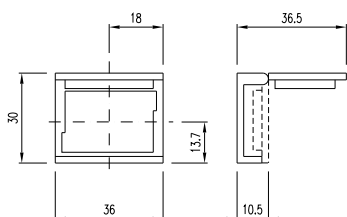

2 Indicator actuator page 5

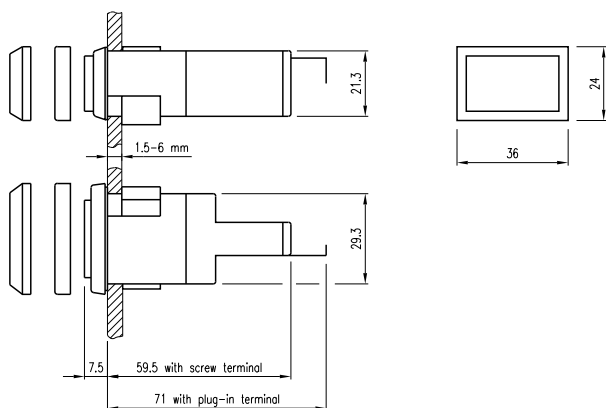

3 Illuminated pushbutton actuator page 6

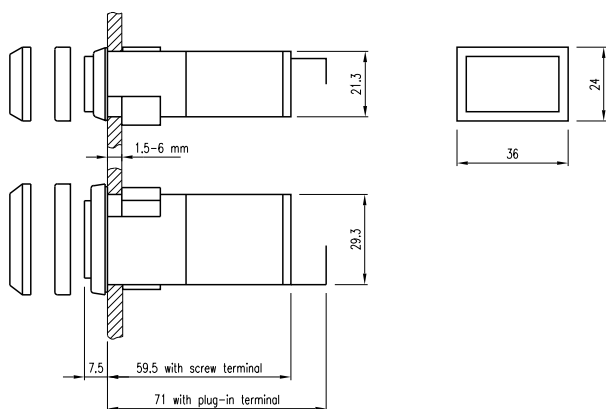

4 Mushroom-head pushbutton actuator page 7

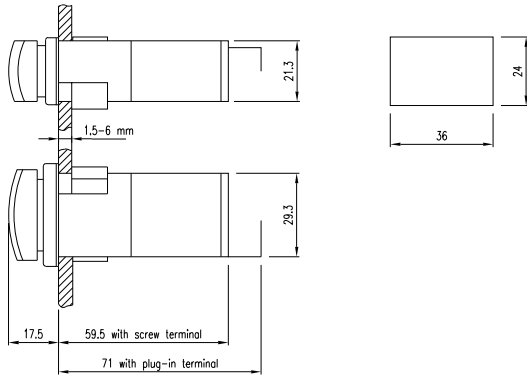

5 Keylock switch 2 positions page 8

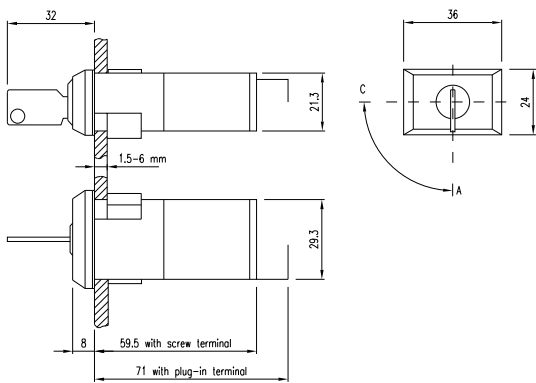

6 Illuminated pushbutton actuator page 6

Circuit drawing

1 Indicator actuator page 5



2 Illuminated pushbutton actuator page 6 | Mushroom-head pushbutton actuator page 7

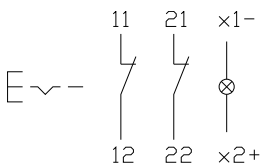

3 Illuminated pushbutton actuator page 6 | Mushroom-head pushbutton actuator page 7

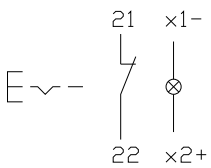

4 Illuminated pushbutton actuator page 6 | Mushroom-head pushbutton actuator page 7

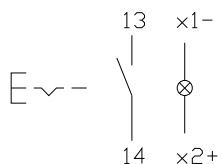

5 Illuminated pushbutton actuator page 6 | Mushroom-head pushbutton actuator page 7

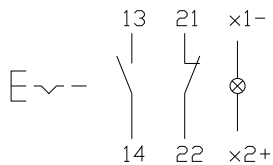

6 Illuminated pushbutton actuator page 6 | Mushroom-head pushbutton actuator page 7

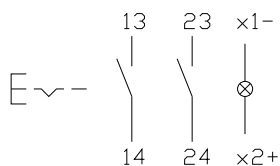

7 Illuminated pushbutton actuator page 6 | Mushroom-head pushbutton actuator page 7

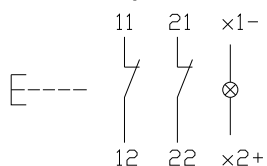

8 Illuminated pushbutton actuator page 6 | Mushroom-head pushbutton actuator page 7

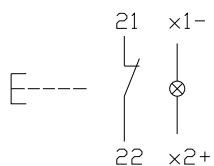

9 Illuminated pushbutton actuator page 6 | Mushroom-head pushbutton actuator page 7

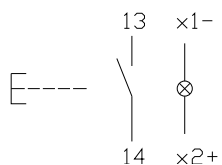

10 Illuminated pushbutton actuator page 6 | Mushroom-head pushbutton actuator page 7

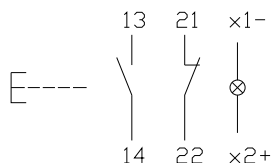

11 Illuminated pushbutton actuator page 6 | Mushroom-head pushbutton actuator page 7

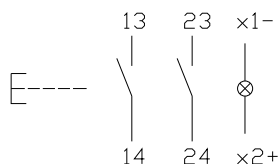

12 Keylock switch 2 positions page 8



13 Keylock switch 2 positions page 8

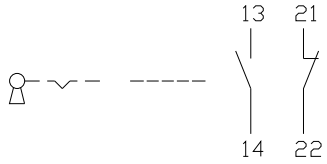

14 Keylock switch 2 positions page 8

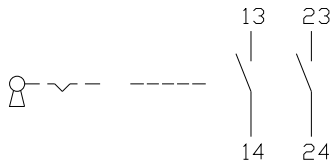

15 Keylock switch 2 positions page 8

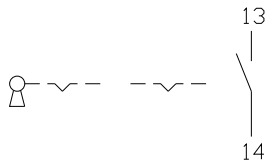

16 Keylock switch 2 positions page 8

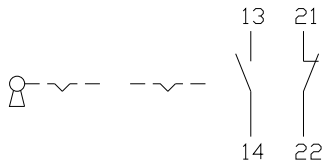

17 Keylock switch 2 positions page 8

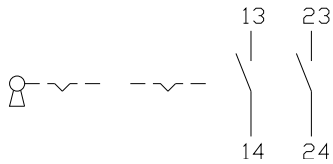

Index from Typ-Nr.

Typ-Nr.	Page	Typ-Nr.	Page	Typ-Nr.	Page
02-904.0	12	22-214.011	7	22-903.5	9
02-904.1	12	22-214.014	6	22-903.6	9
02-904.3	12	22-214.014	7	22-903.7	9
02-904.7	12	22-215.011	6	22-905.2	9
02-905	12	22-215.011	7	22-905.4	9
02-912.1	12	22-215.014	6	22-905.5	9
02-912.2	12	22-215.014	7	22-905.7	9
02-912.3	12	22-221.011	6	22-925	10
02-912.4	12	22-221.011	7	22-930.0	9
02-965.0	9	22-221.014	6	22-930.2	9
02-967.0	9	22-221.014	7	22-930.4	9
10-1306.1349	11	22-222.011	6	22-930.5	9
10-1307.1369	11	22-222.011	7	22-938	12
10-1309.1309	11	22-222.014	6	22-949.0	10
10-1310.1319	11	22-222.014	7	31-989.300	10
10-1311.1249	11	22-223.011	6	31-989.311	10
10-1312.1229	11	22-223.011	7	61-9740.0	12
10-1313.1209	11	22-223.014	6	98-968	12
10-1313.1249	11	22-223.014	7		
10-1316.1179	11	22-224.011	6		
10-1316.1209	11	22-224.011	7		
10-1319.1179	11	22-224.014	6		
10-1319.1199	11	22-224.014	7		
10-2J06.3142	11	22-225.011	6		
10-2J06.3144	11	22-225.011	7		
10-2J06.3145	11	22-225.014	6		
10-2J06.3146	11	22-225.014	7		
10-2J06.3149	11	22-331.111D	8		
10-2J09.1062	11	22-331.114D	8		
10-2J09.1064	11	22-331.311D	8		
10-2J09.1065	11	22-331.314D	8		
10-2J09.1066	11	22-331.511D	8		
10-2J09.1069	11	22-331.514D	8		
10-2J12.1062	11	22-333.111D	8		
10-2J12.1064	11	22-333.114D	8		
10-2J12.1065	11	22-333.311D	8		
10-2J12.1066	11	22-333.314D	8		
10-2J12.1069	11	22-333.511D	8		
10-2J13.1062	11	22-333.514D	8		
10-2J13.1064	11	22-335.111D	8		
10-2J13.1065	11	22-335.114D	8		
10-2J13.1066	11	22-335.311D	8		
10-2J13.1069	11	22-335.314D	8		
10-2J19.1042	11	22-335.511D	8		
10-2J19.1044	11	22-335.514D	8		
10-2J19.1045	11	22-351.111D	8		
10-2J19.1046	11	22-351.114D	8		
10-2J19.1049	11	22-353.111D	8		
22-040.001	5	22-353.114D	8		
22-040.004	5	22-355.111D	8		
22-211.011	6	22-355.114D	8		
22-211.011	7	22-901.0	9		
22-211.014	6	22-901.2	9		
22-211.014	7	22-901.3	9		
22-212.011	6	22-901.4	9		
22-212.011	7	22-901.5	9		
22-212.014	6	22-901.6	9		
22-212.014	7	22-901.8	9		
22-213.011	6	22-901.9	9		
22-213.011	7	22-903.1	9		
22-213.014	6	22-903.2	9		
22-213.014	7	22-903.3	9		
22-214.011	6	22-903.4	9		

	EAO AG
	Tannwaldstrasse 88 4601 Olten, Switzerland
E-mail	info@eao.com
Website	www.eao.com
	Austria
Phone	+49 201 85 87 0
Fax	+49 201 85 87 210
E-mail	sales.ede@eao.com
	Belgium
Phone	+32 3 777 82 36
Fax	+32 3 777 84 19
E-mail	sales.ebl@eao.com
	China
Phone	+852 27 86 91 41
Fax	+852 27 86 95 61
E-mail	sales.ehk@eao.com
	France
Phone	+33 1 64 43 37 37
Fax	+33 1 64 43 37 49
E-mail	sales.esa@eao.com
	Germany
Phone	+49 201 85 87 0
Fax	+49 201 85 87 210
E-mail	sales.ede@eao.com
	Italy
Phone	+39 035 481 0189
Fax	+39 035 481 3786
E-mail	sales.eit@eao.com
	Japan
Phone	+81 3 5401 0953
Fax	+81 3 5444 0345
E-mail	sales.esj@eao.com
	Netherlands
Phone	+31 78 653 17 00
Fax	+31 78 653 17 99
E-mail	sales.enl@eao.com
	Sweden
Phone	+46 8 683 86 60
Fax	+46 8 724 29 12
E-mail	sales.esw@eao.com
	Switzerland
Phone	+41 62 388 95 00
Fax	+41 62 388 95 55
E-mail	sales.ech@eao.com
	United Kingdom
Phone	+44 1444 236 000
Fax	+44 1444 236 641
E-mail	sales.euk@eao.com
	USA
Phone	+1 203 877 4577
Fax	+1 203 877 3694
E-mail	sales.eus@eao.com
	Other Countries
Phone	+41 62 286 92 10
Fax	+41 62 296 21 62
E-mail	info@eao.com

Компания «Океан Электроники» предлагает заключение долгосрочных отношений при поставках импортных электронных компонентов на взаимовыгодных условиях!

Наши преимущества:

- Поставка оригинальных импортных электронных компонентов напрямую с производств Америки, Европы и Азии, а так же с крупнейших складов мира;
- Широкая линейка поставок активных и пассивных импортных электронных компонентов (более 30 млн. наименований);
- Поставка сложных, дефицитных, либо снятых с производства позиций;
- Оперативные сроки поставки под заказ (от 5 рабочих дней);
- Экспресс доставка в любую точку России;
- Помощь Конструкторского Отдела и консультации квалифицированных инженеров;
- Техническая поддержка проекта, помощь в подборе аналогов, поставка прототипов;
- Поставка электронных компонентов под контролем ВП;
- Система менеджмента качества сертифицирована по Международному стандарту ISO 9001;
- При необходимости вся продукция военного и аэрокосмического назначения проходит испытания и сертификацию в лаборатории (по согласованию с заказчиком);
- Поставка специализированных компонентов военного и аэрокосмического уровня качества (Xilinx, Altera, Analog Devices, Intersil, Interpoint, Microsemi, Actel, Aeroflex, Peregrine, VPT, Syfer, Eurofarad, Texas Instruments, MS Kennedy, Miteq, Cobham, E2V, MA-COM, Hittite, Mini-Circuits, General Dynamics и др.);

Компания «Океан Электроники» является официальным дистрибьютором и эксклюзивным представителем в России одного из крупнейших производителей разъемов военного и аэрокосмического назначения «JONHON», а так же официальным дистрибьютором и эксклюзивным представителем в России производителя высокотехнологичных и надежных решений для передачи СВЧ сигналов «FORSTAR».



JONHON

«JONHON» (основан в 1970 г.)

Разъемы специального, военного и аэрокосмического назначения:

(Применяются в военной, авиационной, аэрокосмической, морской, железнодорожной, горно- и нефтедобывающей отраслях промышленности)

«FORSTAR» (основан в 1998 г.)

ВЧ соединители, коаксиальные кабели, кабельные сборки и микроволновые компоненты:

(Применяются в телекоммуникациях гражданского и специального назначения, в средствах связи, РЛС, а так же военной, авиационной и аэрокосмической отраслях промышленности).



Телефон: 8 (812) 309-75-97 (многоканальный)

Факс: 8 (812) 320-03-32

Электронная почта: ocean@oceanchips.ru

Web: <http://oceanchips.ru/>

Адрес: 198099, г. Санкт-Петербург, ул. Калинина, д. 2, корп. 4, лит. А