

# P Series



**UL Recognized  
CSA Certified  
VDE Approved**



## P Series

The P series power entry module offers fuller flexibility of design in a more compact package.

As the first 10 amp module to provide all five power entry functions in one compact design, the CHAMELEON module readily adapts to its environment and the needs of international markets.

- Snap-in or flange mounting
- IEC power line connector
- Both North American and European fusing capabilities
- Two voltage selections
- Optional DPST on/off switch
- Filtering options for general purpose, medical and high-performance applications.

The CHAMELEON modules compact design and modular construction will allow you to select the power entry features you require — without altering the panel cutout. And the Chameleon module, with adapters, will fit any standard panel cutout.

The CHAMELEON module has four filter options. **S models** offer protection for general purpose applications where line-to-ground and line-to-line noise must be controlled. The filters are designed to meet low leakage requirements of VDE portable equipment. They are available in current ratings of 3, 6 and 10 amps.

**H models** provide susceptibility protection without leakage current associated with line-to-ground capacitors and are designed to allow equipment to meet UL 544 for patient care and non-patient care equipment.

Also available is an interconnection block, **B models**. The block connects the voltage selection terminals of an unfiltered CHAMELEON module with a switch and an IEC connector to reduce external wiring.

**L Models** – High performance medical filter versions that are designed to help bring most digital equipment (including switching power supplies) into compliance with EN55022, Level B (as well as FCC part 15J, Class B) conducted emissions limits while additionally allowing equipment to meet UL544, UL2601 and EN60601 for patient care equipment and non-patient care equipment. They are available with current ratings of 6 and 10 amps. High performance versions are available with horizontal mounting ears, single voltage, complete can shield with options for switch, fuses and current ratings only. Extenders are not available.

**Z Models** – High performance filter versions are designed to help bring most digital equipment (including switching power supplies) into compliance with EN55022, Level B (as well as FCC Part 15J, Class B) conducted emissions limits. They are available with current ratings of 6 and 10 amps. High performance versions are available with horizontal mounting ears, no extenders, single voltage, complete can shield with options for switch, fuses and current ratings only.



PE Filter with "A" Shield



Tyco Electronics  
CORCOM Products

# P Series

## P Series Part Number Schematic

Part numbers are constructed by selecting the alphanumeric character which represents the desired feature.

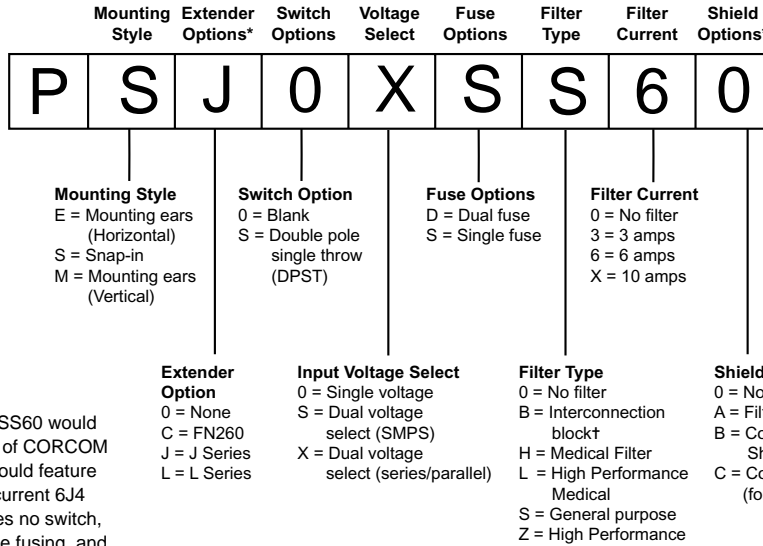

The part number PSJ0XSS60 would represent the equivalent of CORCOM J Series 6J4. The part would feature the J extender to fit the current 6J4 panel cutout, and includes no switch, dual voltage select, single fusing, and a 6-amp general purpose filter.

## Part Numbers (partial list)

PS000S000	PE000DL6C
PS0XSS000	PE000DLXC
PS0S0SBX0	PE000DZ6C
PS000SH30	PE000DZXC
PS00SDH3A	PE000SL6C
PS0S0SH60	PE000SLXC
PS0SSDH6A	PE000SZ6C
PS00SSHXA	PE000SZXC
PS0SSSHX0	PE000SS30
PS000SS30	PE0S0SS30
PS0S0SS30	PE000SS60
PS0SSSS6B	PE0SSSSX0
PS0SXDS60	PE000SZXC
PSJ0XSS60	PE0SSS000
PSLS0SS60	PE0SSSH60
PS0SXSS60	PE0S0DL6C
PS00SSSXA	PE0S0DLXC
PS0SSSSX0	PE0S0DZ6C
	PE0S0DZXC
	PE0S0SL6C
	PE0S0SLXC
	PE0S0SZ6C
	PE0S0SZXC

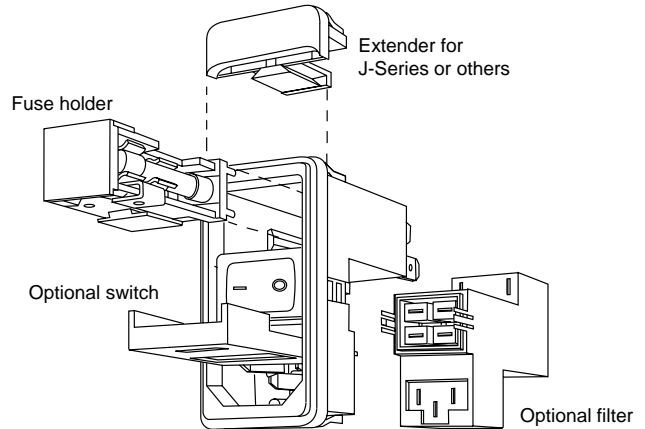

Additional extender which allows the P series to adapt to CORCOM's L series product cutout, as well as the panel cutout of Schaffner and Delta parts is available.

\* Extenders cannot be added to units with B shields.

† When using the interconnection block, the last 3 digits of the part number are BX(0, A, or B).

# P Series

## Voltage Selection

The P series of power entry modules provides a dual voltage selector which is integrated with the fuseholder. To simplify the wiring in each individual application, Tyco Electronics provides dedicated voltage selectors for different voltage selection schemes. The two most popular schemes are the parallel and serial for dual primary transformers and the "DPST switch" for switching mode power supplies (jumper types.) P series products with an "S" as the fifth digit are specifically designed for "jumper" type applications associated with switching mode power supplies.

P series products with an "X" as the fifth digit are specifically designed for dual primary transformer applications. The voltage selector installed will allow proper wiring from these applications. No matter what voltage selection scheme is used, wiring is always made to the same four terminals.

## Fuseholder

Another feature of the P series power entry module is a versatile fusing arrangement. Its fuseholder can hold two 1/4" x 1-1/4" or 5 x 20mm fuses. It can also be converted to accept one fuse with a conversion clip that bridges one of the two fuse chambers.

The conversion clip is installed on the P Series power entry modules set for single fusing (those with part numbers with an "S" as the sixth digit). Units with a "D" as the sixth digit do not include a conversion clip.

## Interconnection Block

Installation of the unfiltered versions of the P series involves wiring of the IEC socket to the switch and the switch to the fuseholder. Labor can be eliminated by ordering the product with an interconnection block. This feature, designated by a BX in the seventh and eighth digits, prewires the module for easier installation. The wiring is protected with the plastic case to better prevent access to the terminals and connections.

Wiring can be further simplified by ordering a PA100 connector assembly. See page 131 for accessories.

The dimensions of this alternative are the same as the filtered versions.



A Shield

B Shield

## Filter Options

Four filtering options are available in three current ratings. S models (those with an S as the seventh digit) provide general purpose filtering for both line-to-ground and line-to-line noise. The increased inductance of the P series allows better performance than most power entry modules on the market. The S models will generally allow compliance with FCC limits for linear power supplies.

The high-performance Z models are available for general applications requiring higher attenuation.

The H models greatly reduce line-to-ground capacitance in compliance with UL 544 low leakage current specification.

The high-performance L models are available for medical applications requiring higher attenuation.

## Electrical Schematics

H Model

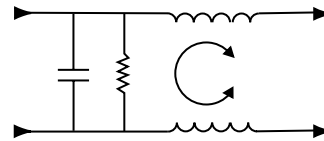

S Model

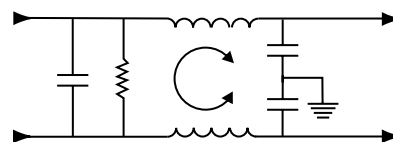

L Model

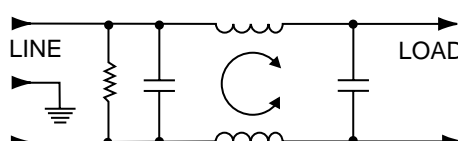

Z Model

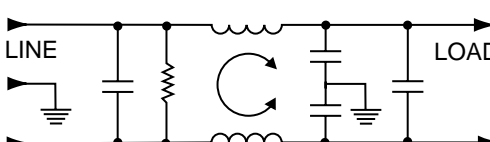

## Shield

A new feature available on the P series is an RF shield. The metal shield, available on filtered models, provides shielding from radiated emissions and provides an additional RF ground for the filter to the case.

The shield is available in two versions, a shield of the filter components (designated by A as the ninth digit) and a complete shield (designated by B as the ninth digit).

The A shield covers the filter portion of the module and increases performance of the filter by protecting the components from magnetic coupling. This shield improves RF ground connection to the case while still allowing the use of the P Series extender.

The B shield covers the entire power entry module with metal, protecting the equipment from all radiated noise. Used with the filter, the shield provides the most secure protection from RFI noise problems. The B shield cannot be used with any extender.

# P Series

## Specifications – Unfiltered Models

**Hipot rating (one minute):**  
 line-to-ground 1500 VAC  
 line-to-line 1450 VDC

**Operating frequency:** 50/60 Hz

**Rated voltage (max.):** 250 VAC

**Rated current, all unfiltered models:** 10A @ 120 VAC  
 10A @ 250 VAC

**Operating voltages: Selectable or fixed** 115/230 VAC

**Fuseholder:** Accepts one or two fuses  
 1/4 x 1-1/4 or 5 x 20 mm  
 Conversion clip provided on fuseholder for single fuse models.

**Switch:** Double-insulated rated for 10,000 operations at full load.  
 51 Amp inrush capability

**Terminals:** .187 x .032 [4.8 x .87] terminal tabs  
 Recommended use connector - no solder

## Voltage Selection Schemes

### 1) Dual Primary Transformer Type:

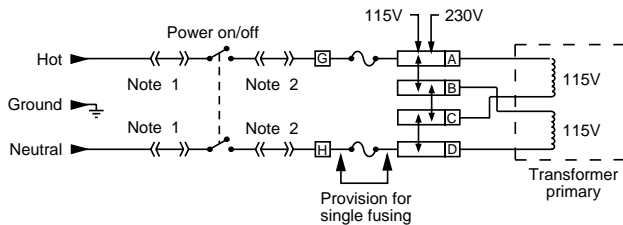

### 2) Jumper Type:

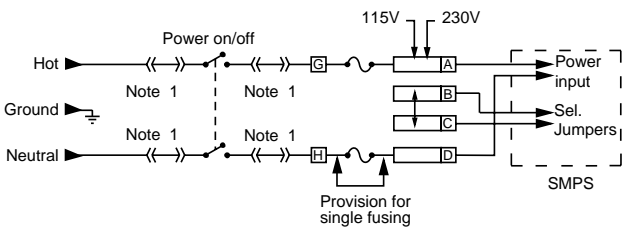

Note 1: Jumpers are required if a filter or interconnection module is not used.

Note 2: Location of optional filter. Jumpers are required if a filter or interconnection module is not used.

## Specifications – Filtered Models

**Maximum leakage current, each line-to-ground:**  
 @ 120 VAC 60 Hz: H Models 2 µA  
 S Models 0.25 mA  
 @ 250 VAC 50 Hz: H Models 5 µA  
 S Models .50 mA

**Hipot rating (one minute):**  
 line-to-ground 1500 VAC  
 line-to-line 1450 VAC

**Operating voltages:** Selectable or fixed 115/230 VAC

**Operating frequency:** 50/60 Hz

**Rated voltage:** 120/250 VAC  
 Conversion clip provided on fuseholder for single fuse models

**Switch:** Double-insulated, rated for 10,000 operations at full load.  
 51 Amp inrush capability.

**Terminals:** .187 x .032 [4.8 x .87] terminal tabs

### Minimum insertion loss in dB:

Line-to-ground in 50 ohm circuit

Current Rating	Frequency-MHz								
	.03	.1	.15	.5	1	3	5	10	30
<b>H Models</b>									
3A	7	17	21	27	30	29	26	23	15
6A	-	8	11	15	17	19	18	16	13
10A	3	5	8	10	12	11	11	10	10
<b>S Models</b>									
3A	7	17	21	27	33	40	44	50	32
6A	-	8	12	17	23	32	36	44	30
10A	-	3	5	10	13	23	27	35	27

Current Rating	Frequency-MHz								
	.01	.05	.1	.15	.5	1	5	10	30
<b>Z Models</b>									
6A	8	21	27	30	37	43	49	52	42
10A	5	17	22	24	27	32	52	47	40
<b>L Models</b>									
6A	8	21	27	29	34	35	25	21	16
10A	5	17	22	23	24	25	21	18	14

Line-to-line in 50 ohm circuit

Current Rating	Frequency-MHz								
	.10	.15	.5	1	3	5	10	30	
<b>H Models</b>									
3A	2	4	12	18	31	40	48	41	
6A	2	4	12	16	26	35	40	35	
10A	2	4	12	16	26	33	40	32	
<b>S Models</b>									
3A	2	4	12	15	30	48	50	45	
6A	2	4	12	15	22	42	55	45	
10A	2	4	12	15	22	42	55	45	

Current Rating	Frequency-MHz								
	.01	.05	.1	.15	.5	1	5	10	30
<b>Z Models</b>									
6A	10	15	34	44	75	75	75	70	60
10A	10	20	20	35	67	75	75	70	60
<b>L Models</b>									
6A	10	15	34	44	75	75	75	70	60
10A	10	20	20	35	67	75	75	70	60

# P Series

## Case Styles

### PS/PSL

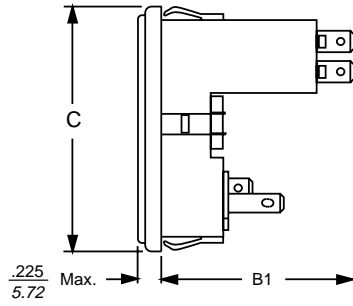
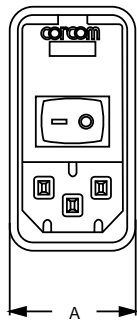

### Filtered

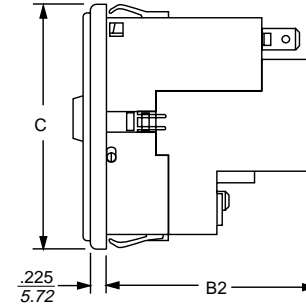

### Panel Cutout

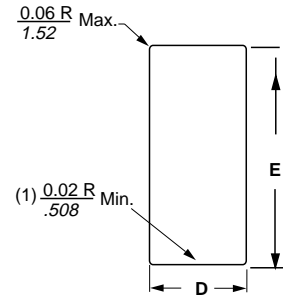

(1) For snap-in applications, the D sides of the cutout must have a .02 [.508] radius on the installation side. Note: Snap-in models allow front mounting only. PS not recommended for plastic panels.

### PE

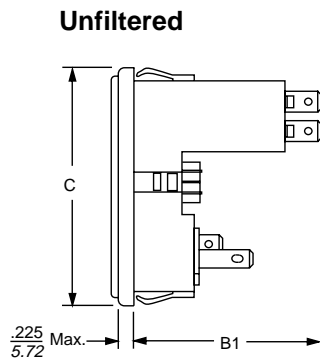
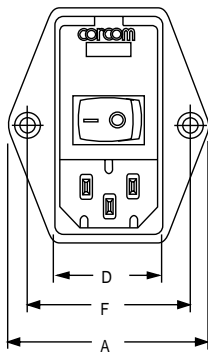

### Filtered

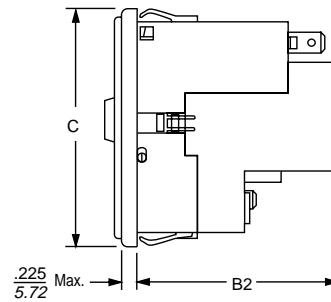

### Panel Cutout

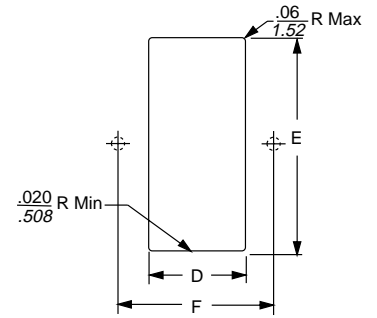

### PM

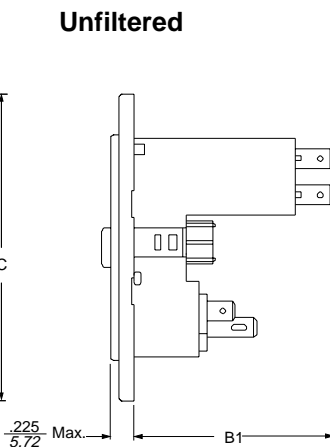
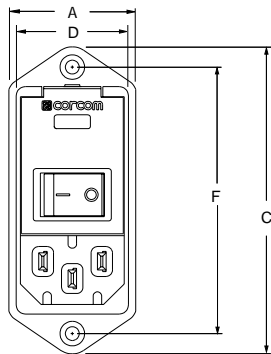

### Filtered

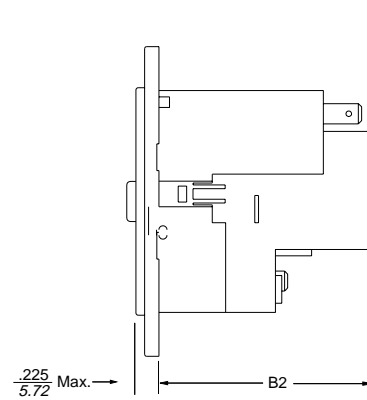

### Panel Cutout

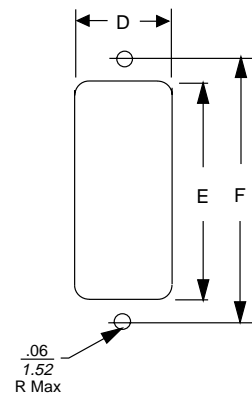

# P Series

## Case Styles

### PSC/PSJ

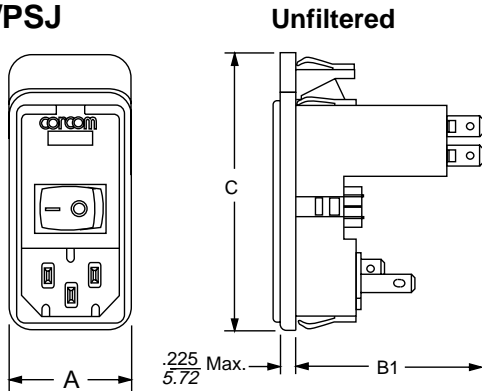

### Filtered

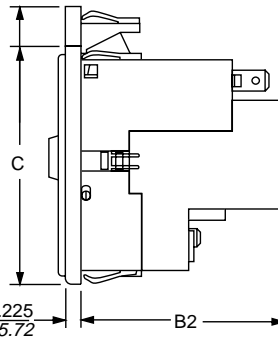

### Panel Cutout

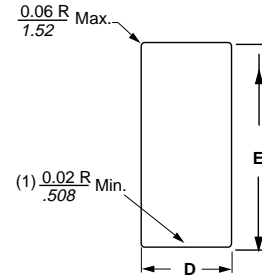

(1) For snap-in applications, the D sides of the cutout must have a .02 [.508] radius on the installation side. Note: Snap-in models allow front mounting only. PS not recommended for plastic panels.

## Filtered Versions

### "A" Shield

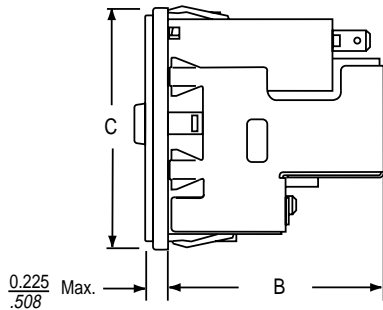

### "B" Shield

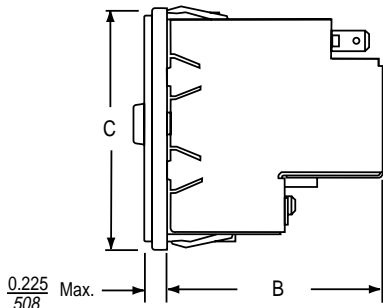

## Case Dimensions

Part No.	A (max)	B1 (max)	B2 (max)	C (max)	D <sup>+0.08/-0.00</sup> / <sub>+20/-00</sub>	E <sup>+0.08/-0.00</sup> / <sub>+20/-00</sub>	F
PS	1.24 31.49	1.93 49.02	2.13 54.1	2.31 58.67	1.06 $\Delta$ 26.93	2.201* 55.91	—
PSL	1.24 31.49	1.93 49.02	2.13 54.1	2.31 58.67	1.12 28.45	2.201* 55.91	—
PE	1.98 50.29	1.93 49.02	2.13 54.1	2.31 58.67	1.122 28.5	2.201* 55.91	1.575 40.0
PM	1.24 31.49	1.93 49.02	2.13 54.1	2.9 73.66	1.06 26.93	2.13 54.1	2.496 63.4
PSC	1.24 31.49	1.93 49.02	2.13 54.1	2.51 63.75	1.06 26.93	2.52 64.01	—
PSJ	1.24 31.49	1.93 49.02	2.13 54.1	2.72 69.09	1.06 26.93	2.6 <sup>+</sup> 66.0	—

\* Panel cutout for thickness of .031 - .079 [0.8 - 2.0]. For panel thickness at .083 - .114 [2.1 - 2.9] use 2.213 [56.21].

+ Panel cutout for thickness of 0.06 - 0.09 [0.76 - 2.29].

$\Delta$  For shielded models use D=1.12 +.008/-0.000.

Shields can be used only with filtered models.

Shields add approximately 0.06" to depth.

B shield may not be used with J or C extender.

## Rear View

### Filtered

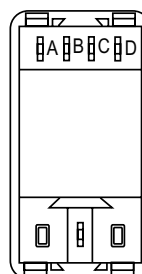

### Unfiltered

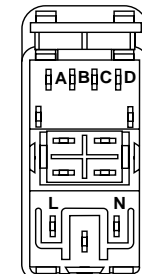

Компания «Океан Электроники» предлагает заключение долгосрочных отношений при поставках импортных электронных компонентов на взаимовыгодных условиях!

Наши преимущества:

- Поставка оригинальных импортных электронных компонентов напрямую с производств Америки, Европы и Азии, а так же с крупнейших складов мира;
- Широкая линейка поставок активных и пассивных импортных электронных компонентов (более 30 млн. наименований);
- Поставка сложных, дефицитных, либо снятых с производства позиций;
- Оперативные сроки поставки под заказ (от 5 рабочих дней);
- Экспресс доставка в любую точку России;
- Помощь Конструкторского Отдела и консультации квалифицированных инженеров;
- Техническая поддержка проекта, помощь в подборе аналогов, поставка прототипов;
- Поставка электронных компонентов под контролем ВП;
- Система менеджмента качества сертифицирована по Международному стандарту ISO 9001;
- При необходимости вся продукция военного и аэрокосмического назначения проходит испытания и сертификацию в лаборатории (по согласованию с заказчиком);
- Поставка специализированных компонентов военного и аэрокосмического уровня качества (Xilinx, Altera, Analog Devices, Intersil, Interpoint, Microsemi, Actel, Aeroflex, Peregrine, VPT, Syfer, Eurofarad, Texas Instruments, MS Kennedy, Miteq, Cobham, E2V, MA-COM, Hittite, Mini-Circuits, General Dynamics и др.);

Компания «Океан Электроники» является официальным дистрибьютором и эксклюзивным представителем в России одного из крупнейших производителей разъемов военного и аэрокосмического назначения «JONHON», а так же официальным дистрибьютором и эксклюзивным представителем в России производителя высокотехнологичных и надежных решений для передачи СВЧ сигналов «FORSTAR».



## JONHON

«JONHON» (основан в 1970 г.)

Разъемы специального, военного и аэрокосмического назначения:

(Применяются в военной, авиационной, аэрокосмической, морской, железнодорожной, горно- и нефтедобывающей отраслях промышленности)

«FORSTAR» (основан в 1998 г.)

ВЧ соединители, коаксиальные кабели, кабельные сборки и микроволновые компоненты:

(Применяются в телекоммуникациях гражданского и специального назначения, в средствах связи, РЛС, а так же военной, авиационной и аэрокосмической отраслях промышленности).



Телефон: 8 (812) 309-75-97 (многоканальный)

Факс: 8 (812) 320-03-32

Электронная почта: [ocean@oceanchips.ru](mailto:ocean@oceanchips.ru)

Web: <http://oceanchips.ru/>

Адрес: 198099, г. Санкт-Петербург, ул. Калинина, д. 2, корп. 4, лит. А