

MC74LCX06

Low-Voltage CMOS Hex Inverter with Open Drain Outputs

With 5 V – Tolerant Inputs

The MC74LCX06 is a high performance hex inverter operating from a 2.3 V to 3.6 V supply. High impedance TTL compatible inputs significantly reduce current loading to input drivers. These LCX devices have open drain outputs which provide the ability to set output levels, or do active-HIGH AND or active-LOW OR functions. A V_I specification of 5.5 V allows MC74LCX06 inputs to be safely driven from 5.0 V devices.

Features

- Designed for 2.3 V to 3.6 V V_{CC} Operation
- 5.0 V Tolerant Inputs/Outputs
- LVTTTL Compatible
- LVCMOS Compatible
- 24 mA Output Sink Capability
- Near Zero Static Supply Current (10 μ A) Substantially Reduces System Power Requirements
- Latchup Performance Exceeds 500 mA
- Wired-OR, Wired-AND
- Output Level Can Be Set Externally Without Affecting Speed of Device
- Functionally Compatible with LCX05
- ESD Performance: Human Body Model >1500 V;
Machine Model >200 V
- These Devices are Pb-Free, Halogen Free/BFR Free and are RoHS Compliant

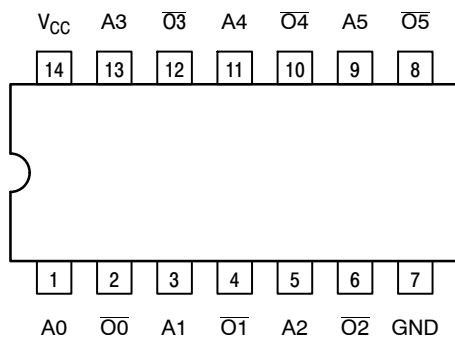

Figure 1. Pinout: 14-Lead (Top View)



ON Semiconductor®

<http://onsemi.com>

MARKING DIAGRAMS

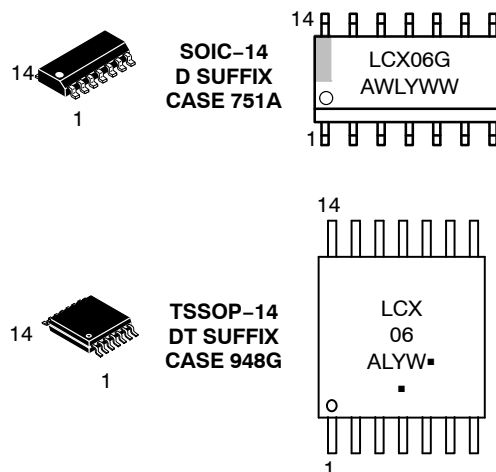

A = Assembly Location
WL, L = Wafer Lot
Y = Year
WW, W = Work Week
G or \blacksquare = Pb-Free Package

(Note: Microdot may be in either location)

ORDERING INFORMATION

See detailed ordering and shipping information in the package dimensions section on page 2 of this data sheet.

MC74LCX06



Figure 2. Logic Diagram

Table 1. PIN NAMES

| Pins | Function |
|---------------------------|------------------------|
| A_n \overline{O}_n | Data Inputs Outputs |

Table 2. TRUTH TABLE

| A_n | \overline{O}_n |
|-------|------------------|
| L | Z |
| H | L |

MAXIMUM RATINGS

| Symbol | Parameter | Value | Condition | Unit |
|-----------|----------------------------------|---------------------------|--------------------------------------|-------------|
| V_{CC} | DC Supply Voltage | -0.5 to +7.0 | | V |
| V_I | DC Input Voltage | $-0.5 \leq V_I \leq +7.0$ | | V |
| V_O | DC Output Voltage | $-0.5 \leq V_O \leq +7.0$ | Output in HIGH or LOW State (Note 1) | V |
| I_{IK} | DC Input Diode Current | -50 | $V_I < GND$ | mA |
| I_{OK} | DC Output Diode Current | -50 | $V_O < GND$ | mA |
| | | +50 | $V_O > V_{CC}$ | mA |
| I_O | DC Output/Sink Current | +50 | | mA |
| I_{CC} | DC Supply Current Per Supply Pin | ± 100 | | mA |
| I_{GND} | DC Ground Current Per Ground Pin | ± 100 | | mA |
| T_{STG} | Storage Temperature Range | -65 to +150 | | $^{\circ}C$ |
| MSL | Moisture Sensitivity | | Level 1 | |

Maximum ratings are those values beyond which device damage can occur. Maximum ratings applied to the device are individual stress limit values (not normal operating conditions) and are not valid simultaneously. If these limits are exceeded, device functional operation is not implied, damage may occur and reliability may be affected.

1. I_O absolute maximum rating must be observed.

ORDERING INFORMATION

| Device | Package | Shipping [†] |
|----------------|-----------------------|-----------------------|
| MC74LCX06DG | SOIC-14 (Pb-Free) | 55 Units / Rail |
| MC74LCX06DR2G | SOIC-14 (Pb-Free) | 2500 / Tape & Reel |
| MC74LCX06DTG | TSSOP-14 (Pb-Free) | 96 Units / Rail |
| MC74LCX06DTR2G | TSSOP-14 (Pb-Free) | 2500 / Tape & Reel |

[†]For information on tape and reel specifications, including part orientation and tape sizes, please refer to our Tape and Reel Packaging Specifications Brochure, BRD8011/D.

MC74LCX06

RECOMMENDED OPERATING CONDITIONS

| Symbol | Parameter | Min | Typ | Max | Unit | |
|-----------------|--|---------------------|-----|---|------------------|----|
| V _{CC} | Supply Voltage | Operating | 2.0 | 2.5, 3.3 | 3.6 | V |
| | | Data Retention Only | 1.5 | 2.5, 3.3 | 3.6 | |
| V _I | Input Voltage | 0 | | 5.5 | V | |
| V _O | Output Voltage (HIGH or LOW State) | 0 | | V _{CC} | V | |
| I _{OL} | LOW Level Output Current Sink | | | V _{CC} = 3.0 V – 3.6 V V _{CC} = 2.7 V – 3.0 V V _{CC} = 2.3 V – 2.7 V | +24 +12 +8 | mA |
| T _A | Operating Free-Air Temperature | -40 | | +85 | °C | |
| Δt/ΔV | Input Transition Rise or Fall Rate, V _{IN} from 0.8 V to 2.0 V, V _{CC} = 3.0 V | 0 | | 10 | ns/V | |

DC ELECTRICAL CHARACTERISTICS (T_A = -40°C to +85°C)

| Symbol | Characteristic | Condition | Min | Max | Unit |
|------------------|---------------------------------------|--|-----|------|------|
| V _{IH} | HIGH Level Input Voltage (Note 2) | 2.3 V ≤ V _{CC} ≤ 2.7 V | 1.7 | | V |
| | | 2.7 V ≤ V _{CC} ≤ 3.6 V | 2.0 | | |
| V _{IL} | LOW Level Input Voltage (Note 2) | 2.3 V ≤ V _{CC} ≤ 2.7 V | | 0.7 | V |
| | | 2.7 V ≤ V _{CC} ≤ 3.6 V | | 0.8 | |
| V _{OL} | LOW Level Output Voltage | 2.3 V ≤ V _{CC} ≤ 3.6 V; I _{OL} = 100 μA | | 0.2 | V |
| | | V _{CC} = 2.3 V; I _{OL} = 8 mA | | 0.3 | |
| | | V _{CC} = 2.7 V; I _{OL} = 12 mA | | 0.4 | |
| | | V _{CC} = 3.0 V; I _{OL} = 16 mA | | 0.4 | |
| | | V _{CC} = 3.0 V; I _{OL} = 24 mA | | 0.55 | |
| I _{OZ} | 3-State Output Current | V _{CC} = 3.6 V, V _{IN} = V _{IH} or V _{IL} , V _{OUT} = 0 to 5.5 V | | ±5 | μA |
| I _{OFF} | Power Off Leakage Current | V _{CC} = 0, V _{IN} = 5.5 V or V _{OUT} = 5.5 V | | 10 | μA |
| I _{IN} | Input Leakage Current | V _{CC} = 3.6 V, V _{IN} = 5.5 V or GND | | ±5 | μA |
| I _{CC} | Quiescent Supply Current | V _{CC} = 3.6 V, V _{IN} = 5.5 V or GND | | 10 | μA |
| ΔI _{CC} | Increase in I _{CC} per Input | 2.3 V ≤ V _{CC} ≤ 3.6 V One Input at V _{IH} = V _{CC} - 0.6 V | | 500 | μA |

2. These values of V_I are used to test DC electrical characteristics only.

AC ELECTRICAL CHARACTERISTICS (T_A = -40°C to +85°C)

| Symbol | Parameter | V _{CC} = 3.3 V ± 0.3 V C _L = 50 pF | | V _{CC} = 2.7 V C _L = 50 pF | | V _{CC} = 2.5 V ± 0.2 V C _L = 30 pF | | Unit |
|------------------|-------------------|---|-----|---|-----|---|-----|------|
| | | Min | Max | Min | Max | Min | Max | |
| t _{PLZ} | Propagation Delay | 0.8 | 3.7 | 1.0 | 4.1 | 0.8 | 3.5 | ns |
| t _{PZL} | Input to Output | 0.8 | 3.7 | 1.0 | 4.1 | 0.8 | 3.5 | ns |

DYNAMIC SWITCHING CHARACTERISTICS (T_A = +25°C)

| Symbol | Characteristic | Condition | Min | Typ | Max | Unit |
|------------------|-------------------------------------|--|-----|--------------|-----|------|
| V _{OLP} | Dynamic LOW Peak Voltage (Note 3) | V _{CC} = 3.3 V, C _L = 50 pF, V _{IH} = 3.3 V, V _{IL} = 0 V V _{CC} = 2.5 V, C _L = 30 pF, V _{IH} = 2.5 V, V _{IL} = 0 V | | 0.9 0.7 | | V |
| V _{OLV} | Dynamic LOW Valley Voltage (Note 3) | V _{CC} = 3.3 V, C _L = 50 pF, V _{IH} = 3.3 V, V _{IL} = 0 V V _{CC} = 2.5 V, C _L = 30 pF, V _{IH} = 2.5 V, V _{IL} = 0 V | | -0.8 -0.6 | | V |

3. Number of outputs defined as "n". Measured with "n-1" outputs switching from HIGH-to-LOW or LOW-to-HIGH. The remaining output is measured in the LOW state.

MC74LCX06

CAPACITIVE CHARACTERISTICS

| Symbol | Parameter | Condition | Typical | Unit |
|-----------|-------------------------------|--|---------|------|
| C_{IN} | Input Capacitance | $V_{CC} = 3.3\text{ V}$, $V_I = 0\text{ V}$ or V_{CC} | 7 | pF |
| C_{OUT} | Output Capacitance | $V_{CC} = 3.3\text{ V}$, $V_I = 0\text{ V}$ or V_{CC} | 8 | pF |
| C_{PD} | Power Dissipation Capacitance | 10 MHz, $V_{CC} = 3.3\text{ V}$, $V_I = 0\text{ V}$ or V_{CC} | 25 | pF |

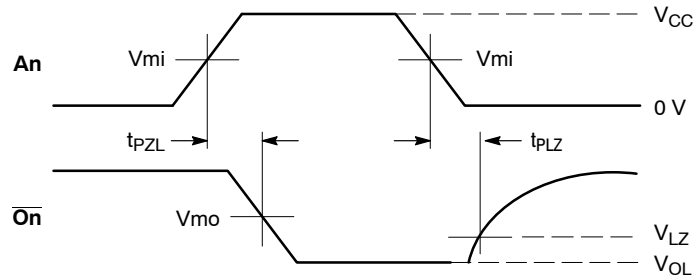

PROPAGATION DELAYS

$$t_R = t_F = 2.5\text{ ns}, 10\% \text{ to } 90\%; f = 1\text{ MHz}; t_W = 500\text{ ns}$$

Table 3. AC WAVEFORMS

| Symbol | V_{CC} | | |
|----------|---------------------------------|-------------------------|---------------------------------|
| | $3.3\text{ V} \pm 0.3\text{ V}$ | 2.7 V | $2.5\text{ V} \pm 0.2\text{ V}$ |
| V_{mi} | 1.5 V | 1.5 V | $V_{CC} / 2$ |
| V_{mo} | 1.5 V | 1.5 V | $V_{CC} / 2$ |
| V_{LZ} | $V_{OL} + 0.3\text{ V}$ | $V_{OL} + 0.3\text{ V}$ | $V_{OL} + 0.15\text{ V}$ |

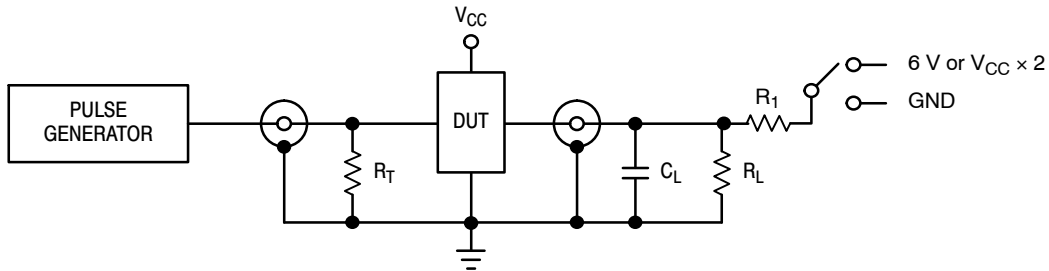

Table 4. TEST CIRCUIT

| TEST | SWITCH |
|--|--------|
| t_{PZL} , t_{PLZ} | 6 V |
| Open Collector/Drain t_{PLH} and t_{PHL} | 6 V |
| t_{PZH} , t_{PHZ} | GND |

$C_L = 50\text{ pF}$ at $V_{CC} = 3.3 \pm 0.3\text{ V}$ or equivalent (includes jig and probe capacitance)

$C_L = 30\text{ pF}$ at $V_{CC} = 2.5 \pm 0.2\text{ V}$ or equivalent (includes jig and probe capacitance)

$R_L = R_1 = 500\ \Omega$ or equivalent

$R_T = Z_{OUT}$ of pulse generator (typically $50\ \Omega$)

MC74LCX06

PACKAGE DIMENSIONS

SOIC-14 NB
CASE 751A-03
ISSUE K

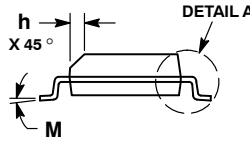
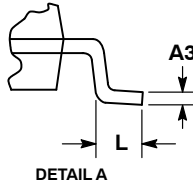
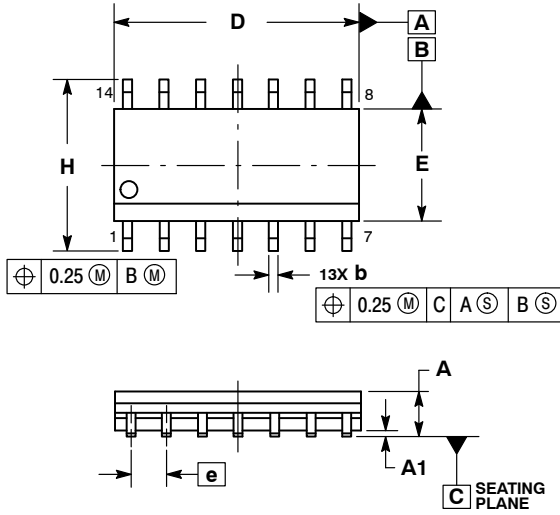

- NOTES:
1. DIMENSIONING AND TOLERANCING PER ASME Y14.5M, 1994.
 2. CONTROLLING DIMENSION: MILLIMETERS.
 3. DIMENSION b DOES NOT INCLUDE DAMBAR PROTRUSION. ALLOWABLE PROTRUSION SHALL BE 0.13 TOTAL IN EXCESS OF AT MAXIMUM MATERIAL CONDITION.
 4. DIMENSIONS D AND E DO NOT INCLUDE MOLD PROTRUSIONS.
 5. MAXIMUM MOLD PROTRUSION 0.15 PER SIDE.

| DIM | MILLIMETERS | | INCHES | |
|-----|-------------|------|-----------|-------|
| | MIN | MAX | MIN | MAX |
| A | 1.35 | 1.75 | 0.054 | 0.068 |
| A1 | 0.10 | 0.25 | 0.004 | 0.010 |
| A3 | 0.19 | 0.25 | 0.008 | 0.010 |
| b | 0.35 | 0.49 | 0.014 | 0.019 |
| D | 8.55 | 8.75 | 0.337 | 0.344 |
| E | 3.80 | 4.00 | 0.150 | 0.157 |
| e | 1.27 BSC | | 0.050 BSC | |
| H | 5.80 | 6.20 | 0.228 | 0.244 |
| h | 0.25 | 0.50 | 0.010 | 0.019 |
| L | 0.40 | 1.25 | 0.016 | 0.049 |
| M | 0° | 7° | 0° | 7° |

SOLDERING FOOTPRINT*

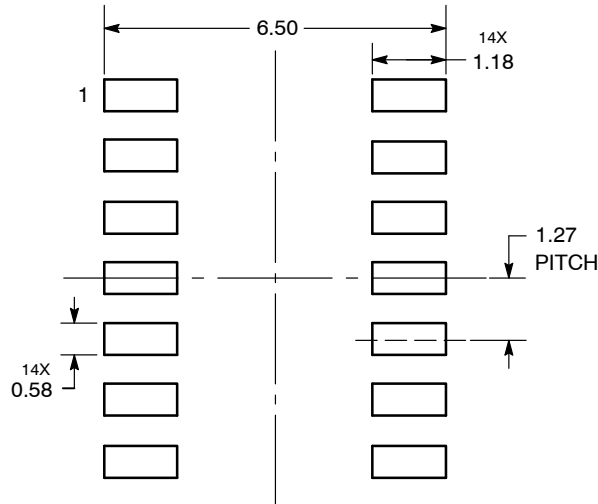

DIMENSIONS: MILLIMETERS

*For additional information on our Pb-Free strategy and soldering details, please download the ON Semiconductor Soldering and Mounting Techniques Reference Manual, SOLDERRM/D.

ON Semiconductor and are registered trademarks of Semiconductor Components Industries, LLC (SCILLC). SCILLC owns the rights to a number of patents, trademarks, copyrights, trade secrets, and other intellectual property. A listing of SCILLC's product/patent coverage may be accessed at www.onsemi.com/site/pdf/Patent-Marking.pdf. SCILLC reserves the right to make changes without further notice to any products herein. SCILLC makes no warranty, representation or guarantee regarding the suitability of its products for any particular purpose, nor does SCILLC assume any liability arising out of the application or use of any product or circuit, and specifically disclaims any and all liability, including without limitation special, consequential or incidental damages. "Typical" parameters which may be provided in SCILLC data sheets and/or specifications can and do vary in different applications and actual performance may vary over time. All operating parameters, including "Typicals" must be validated for each customer application by customer's technical experts. SCILLC does not convey any license under its patent rights nor the rights of others. SCILLC products are not designed, intended, or authorized for use as components in systems intended for surgical implant into the body, or other applications intended to support or sustain life, or for any other application in which the failure of the SCILLC product could create a situation where personal injury or death may occur. Should Buyer purchase or use SCILLC products for any such unintended or unauthorized application, Buyer shall indemnify and hold SCILLC and its officers, employees, subsidiaries, affiliates, and distributors harmless against all claims, costs, damages, and expenses, and reasonable attorney fees arising out of, directly or indirectly, any claim of personal injury or death associated with such unintended or unauthorized use, even if such claim alleges that SCILLC was negligent regarding the design or manufacture of the part. SCILLC is an Equal Opportunity/Affirmative Action Employer. This literature is subject to all applicable copyright laws and is not for resale in any manner.

PUBLICATION ORDERING INFORMATION

LITERATURE FULFILLMENT:
Literature Distribution Center for ON Semiconductor
P.O. Box 5163, Denver, Colorado 80217 USA
Phone: 303-675-2175 or 800-344-3860 Toll Free USA/Canada
Fax: 303-675-2176 or 800-344-3867 Toll Free USA/Canada
Email: orderlit@onsemi.com

N. American Technical Support: 800-282-9855 Toll Free
USA/Canada
Europe, Middle East and Africa Technical Support:
Phone: 421 33 790 2910
Japan Customer Focus Center
Phone: 81-3-5817-1050

ON Semiconductor Website: www.onsemi.com
Order Literature: <http://www.onsemi.com/orderlit>
For additional information, please contact your local Sales Representative

Компания «Океан Электроники» предлагает заключение долгосрочных отношений при поставках импортных электронных компонентов на взаимовыгодных условиях!

Наши преимущества:

- Поставка оригинальных импортных электронных компонентов напрямую с производств Америки, Европы и Азии, а так же с крупнейших складов мира;
- Широкая линейка поставок активных и пассивных импортных электронных компонентов (более 30 млн. наименований);
- Поставка сложных, дефицитных, либо снятых с производства позиций;
- Оперативные сроки поставки под заказ (от 5 рабочих дней);
- Экспресс доставка в любую точку России;
- Помощь Конструкторского Отдела и консультации квалифицированных инженеров;
- Техническая поддержка проекта, помощь в подборе аналогов, поставка прототипов;
- Поставка электронных компонентов под контролем ВП;
- Система менеджмента качества сертифицирована по Международному стандарту ISO 9001;
- При необходимости вся продукция военного и аэрокосмического назначения проходит испытания и сертификацию в лаборатории (по согласованию с заказчиком);
- Поставка специализированных компонентов военного и аэрокосмического уровня качества (Xilinx, Altera, Analog Devices, Intersil, Interpoint, Microsemi, Actel, Aeroflex, Peregrine, VPT, Syfer, Eurofarad, Texas Instruments, MS Kennedy, Miteq, Cobham, E2V, MA-COM, Hittite, Mini-Circuits, General Dynamics и др.);

Компания «Океан Электроники» является официальным дистрибьютором и эксклюзивным представителем в России одного из крупнейших производителей разъемов военного и аэрокосмического назначения «**JONHON**», а так же официальным дистрибьютором и эксклюзивным представителем в России производителя высокотехнологичных и надежных решений для передачи СВЧ сигналов «**FORSTAR**».



JONHON

«**JONHON**» (основан в 1970 г.)

Разъемы специального, военного и аэрокосмического назначения:

(Применяются в военной, авиационной, аэрокосмической, морской, железнодорожной, горно- и нефтедобывающей отраслях промышленности)

«**FORSTAR**» (основан в 1998 г.)

ВЧ соединители, коаксиальные кабели,
кабельные сборки и микроволновые компоненты:

(Применяются в телекоммуникациях гражданского и специального назначения, в средствах связи, РЛС, а так же военной, авиационной и аэрокосмической отраслях промышленности).



Телефон: 8 (812) 309-75-97 (многоканальный)

Факс: 8 (812) 320-03-32

Электронная почта: ocean@oceanchips.ru

Web: <http://oceanchips.ru/>

Адрес: 198099, г. Санкт-Петербург, ул. Калинина, д. 2, корп. 4, лит. А