



FCIconnect.com

Copyright FCI.

1

2

Configuration of customer Documents list

P/N	Documents	No.	Title
SLW__R/S-5C7LF	SPEC	SC-SLW04	
	DWG	JSA96303	CAT NO. TABLE FOR 1mm SPACING CONNECTOR
		JSA96304	1mm SPACING CONNECTOR
		JSA96305	1mm SPACING CONNECTOR
	Cable	JSA92759	RECOMMENDED CABLE (CIC)

P/N	Documents	No.	Title
SLW__R/S-5A7LF	SPEC	SC-SLW04	
	DWG	JSA96309	CAT NO. TABLE FOR 1mm SPACING CONNECTOR
		JSA96310	1mm SPACING CONNECTOR
		JSA96311	1mm SPACING CONNECTOR
	Cable	JSA92759	RECOMMENDED CABLE (CIC)

mat'l. code				surface ISO 1302 <input checked="" type="checkbox"/>		tolerance ISO 406 ISO 1101		projection 		product family 58JF/TF		CODE JP	
ltr	ecn no	dr	date	tolerances unless otherwise specified				mm		title 1mm SPACING CONNECTOR DOCUMENT LIST (Cat. No. SLW__R/S-5__LF)			
A	J05-0079	H.T	'05/2/18	angles	linear			scale \propto		dwg no		sheet 1 of 1 size	
B	J06-0459	H.T	11/8/06							JSA96342		A4	
		dr								type		Product Customer Drawing	
		enr											
		chr											
		app											
sheet index	revision sheet	B	1									Rev. B	

form: A4

1

2

CAT. NO. & DIMENSIONS

NO. OF CONTACTS (n)	CAT. NO.		DIMENSIONS (NOTE1)	
	RIGHT ANGLE TYPE	STRAIGHT TYPE	A ± 0.3	B ± 0.3
4	SLW 4 R-5C7LF	SLW 4 S-5C7LF	10.2	5.2
5	SLW 5 R-5C7LF	SLW 5 S-5C7LF	11.2	6.2
6	SLW 6 R-5C7LF	SLW 6 S-5C7LF	12.2	7.2
7	SLW 7 R-5C7LF	SLW 7 S-5C7LF	13.2	8.2
8	SLW 8 R-5C7LF	SLW 8 S-5C7LF	14.2	9.2
9	SLW 9 R-5C7LF	SLW 9 S-5C7LF	15.2	10.2
10	SLW 10 R-5C7LF	SLW 10S-5C7LF	16.2	11.2
11	SLW 11 R-5C7LF	SLW 11S-5C7LF	17.2	12.2
12	SLW 12 R-5C7LF	SLW 12S-5C7LF	18.2	13.2
13	SLW 13 R-5C7LF	SLW 13S-5C7LF	19.2	14.2
14	SLW 14 R-5C7LF	SLW 14S-5C7LF	20.2	15.2
15	SLW 15 R-5C7LF	SLW 15S-5C7LF	21.2	16.2
16	SLW 16 R-5C7LF	SLW 16S-5C7LF	22.2	17.2
17	SLW 17 R-5C7LF	SLW 17S-5C7LF	23.2	18.2
18	SLW 18 R-5C7LF	SLW 18S-5C7LF	24.2	19.2
19	SLW 19 R-5C7LF	SLW 19S-5C7LF	25.2	20.2
20	SLW 20 R-5C7LF	SLW 20S-5C7LF	26.2	21.2
21	SLW 21 R-5C7LF	SLW 21S-5C7LF	27.2	22.2
22	SLW 22 R-5C7LF	SLW 22S-5C7LF	28.2	23.2
23	SLW 23 R-5C7LF	SLW 23S-5C7LF	29.2	24.2
24	SLW 24 R-5C7LF	SLW 24S-5C7LF	30.2	25.2
25	SLW 25 R-5C7LF	SLW 25S-5C7LF	31.2	26.2
26	SLW 26 R-5C7LF	SLW 26S-5C7LF	32.2	27.2
27	SLW 27 R-5C7LF	SLW 27S-5C7LF	33.2	28.2
28	SLW 28 R-5C7LF	SLW 28S-5C7LF	34.2	29.2
29	SLW 29 R-5C7LF	SLW 29S-5C7LF	35.2	30.2
30	SLW 30 R-5C7LF	SLW 30S-5C7LF	36.2	31.2

CAT. NO. SLW (n) R - 5C7 LF NOTE

SERIES NAME _____
 NO. OF CONTACTS _____
 R:RIGHT ANGLE TYPE
 S:STRAIGHT TYPE
 VARIATION _____
 LEAD FREE _____

1. SEE PART DRAWINGS FOR DIMENSIONS A,B.

mat'l. code				surface ISO 1302 <input checked="" type="checkbox"/>	tolerance ISO 406 ISO 1101	projection	product family 58JF/TF	CODE JP
ltr	ecn no	dr	date	tolerances unless otherwise specified		mm	title	
A	J05-0079	H.T	'05/2/15	angles	linear		CAT NO. TABLE FOR 1mm SPACING CONNECTOR (Cat. No. SLW__R/S-5C7LF)	
B	J06-0459	H.T	11/8/'06			scale \times	dwg no sheet 1 of 1 size	
				dr	<i>H. J. J. 11/8/06</i>		JSA 96303 A4	
				enr	<i>H. J. J. 11/8/06</i>		type Product Customer Drawing	
				chr	<i>R. Shoupe 11/9/06</i>			
				app	<i>S. J. J. 11/9/06</i>			
sheet index	revision sheet	B 1						Rev. B

SC-SLW04 JSA96304 96305 92759 form: A4



FCIconnect.com

Copyright FCI.



PT.NO.	PARTS NAME	MATERIAL	Q'TY	NOTE
1	HOUSING	NYLON RESIN GLASS REINFORCED	1	COLOR : BLACK
2	SLIDER	(UL94V-0)	1	COLOR : WHITE
3	CONTACT	PHOSPHOR BRONZE	n	PLATING : MATTE PURE TIN (LEAD FREE)

RECOMMENDED PC BOARD

THICKNESS : 0.8~1.6
HOLE PATTERN (COMPONENT SIDE)

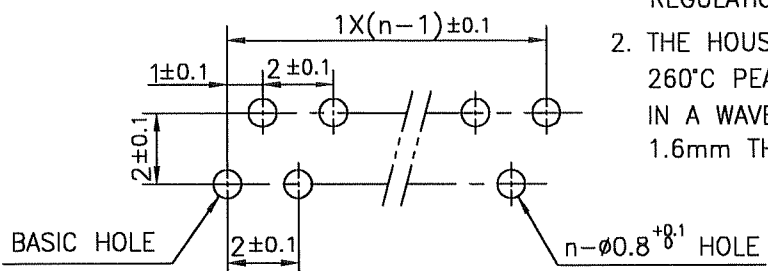

1. THIS PRODUCT MEETS EUROPEAN UNION DIRECTIVES AND OTHER COUNTRY REGULATIONS AS DESCRIBED IN GS-22-008
2. THE HOUSING WILL WITHSTAND EXPOSURE TO 260°C PEAK TEMPERATURE FOR 10 SECONDS IN A WAVE SOLDER APPLICATION WITH A 1.6mm THICK CIRCUIT BOARD.

mat'l. code				surface ISO 1302 ✓		tolerance ISO 406 ISO 1101		projection		product family 58TF		CODE JP		
ltr	ecn no	dr	date	tolerances unless otherwise specified				mm		title				
A	J05-0079	H.T	'05/2/15	±0.3				mm		1mm SPACING CONNECTOR				
B	J05-0734	H.T	10/28/'05	angles	linear			mm		(Cat. No. SLW__R-5C7LF)				
C	J06-0459	H.T	11/8/'06					scale X						
				dr	11/8/06				dwg no		sheet 1 of 1		size	
				enrg	11/8/06				JSA 96305		A4			
				chr	11/9/06				type		Product Customer Drawing			
				appd	11/9/06									
sheet index		revision sheet		C								Rev. C		

SC-SLW04 JSA96303
form: A4

RECOMMENDED CABLE (CIC)



PT. NO.	PARTS NAME	MATERIAL	THICKNESS (μm)	
1	BASE FILM	POLYESTER OR EQUAL	75	25
2	CONDUCTOR	CARBON PASTE OVER SILVER PASTE	10 MIN.	
3	OVERLAY	POLYIMIDE OR POLYESTER OR EQUAL	—	
4	SUPPORTING TAPE	POLYESTER OR POLYIMIDE OR EQUAL	188	250

NOTES

1. NO BURR AT EACH PORTION.
2. NO PEELING IN COMMON USE.
3. TOTAL THICKNESS LIMIT OF EACH MATERIAL (INCLUDING ADHESIVE AGENT) IS SPECIFIED.

mat'l. code				surface <input checked="" type="checkbox"/> ISO 1302 <input type="checkbox"/> tolerance <input checked="" type="checkbox"/> ISO 406 <input type="checkbox"/> ISO 1101		projection		product family 58JF/TF		CODE JP		
ltr	ecn no	dr	date	tolerances unless otherwise specified				title				
AA	J05-0079	H.T	2/18/05					RECOMMENDED CABLE				
AB	J06-0459	H.T	11/8/06	angles	linear	mm		(Cat. No. SLW__R/S-5__)				
						scale \times						
				dr	11/8/06				dwg no		sheet 1 of 1	size
				enr	11/8/06				JSA 92759		A4	
				chr	11/9/06							
				appd	11/9/06							
sheet index	revision sheet	AB	1									Rev. AB

CAT. NO. & DIMENSIONS

NO. OF CONTACTS (n)	CAT. NO.		DIMENSIONS (NOTE1)	
	RIGHT ANGLE TYPE	STRAIGHT TYPE	A ± 0.3	B ± 0.3
4	SLW 4 R-5A7LF	SLW 4 S-5A7LF	10.2	5.2
5	SLW 5 R-5A7LF	SLW 5 S-5A7LF	11.2	6.2
6	SLW 6 R-5A7LF	SLW 6 S-5A7LF	12.2	7.2
7	SLW 7 R-5A7LF	SLW 7 S-5A7LF	13.2	8.2
8	SLW 8 R-5A7LF	SLW 8 S-5A7LF	14.2	9.2
9	SLW 9 R-5A7LF	SLW 9 S-5A7LF	15.2	10.2
10	SLW 10R-5A7LF	SLW 10S-5A7LF	16.2	11.2
11	SLW 11R-5A7LF	SLW 11S-5A7LF	17.2	12.2
12	SLW 12R-5A7LF	SLW 12S-5A7LF	18.2	13.2
13	SLW 13R-5A7LF	SLW 13S-5A7LF	19.2	14.2
14	SLW 14R-5A7LF	SLW 14S-5A7LF	20.2	15.2
15	SLW 15R-5A7LF	SLW 15S-5A7LF	21.2	16.2
16	SLW 16R-5A7LF	SLW 16S-5A7LF	22.2	17.2
17	SLW 17R-5A7LF	SLW 17S-5A7LF	23.2	18.2
18	SLW 18R-5A7LF	SLW 18S-5A7LF	24.2	19.2
19	SLW 19R-5A7LF	SLW 19S-5A7LF	25.2	20.2
20	SLW 20R-5A7LF	SLW 20S-5A7LF	26.2	21.2
21	SLW 21R-5A7LF	SLW 21S-5A7LF	27.2	22.2
22	SLW 22R-5A7LF	SLW 22S-5A7LF	28.2	23.2
23	SLW 23R-5A7LF	SLW 23S-5A7LF	29.2	24.2
24	SLW 24R-5A7LF	SLW 24S-5A7LF	30.2	25.2
25	SLW 25R-5A7LF	SLW 25S-5A7LF	31.2	26.2
26	SLW 26R-5A7LF	SLW 26S-5A7LF	32.2	27.2
27	SLW 27R-5A7LF	SLW 27S-5A7LF	33.2	28.2
28	SLW 28R-5A7LF	SLW 28S-5A7LF	34.2	29.2
29	SLW 29R-5A7LF	SLW 29S-5A7LF	35.2	30.2
30	SLW 30R-5A7LF	SLW 30S-5A7LF	36.2	31.2

CAT. NO. SLW (n) R -5A7 LF

SERIES NAME _____

NO. OF CONTACTS _____



R:RIGHT ANGLE TYPE _____

S:STRAIGHT TYPE _____

VARIATION _____

LEAD FREE _____

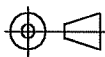
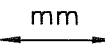
NOTE
1. SEE PART DRAWINGS FOR DIMENSIONS A,B.

mat'l. code				surface <input checked="" type="checkbox"/> ISO 1302 <input checked="" type="checkbox"/> tolerance <input checked="" type="checkbox"/> ISO 406 <input checked="" type="checkbox"/> ISO 1101		projection 		product family 5BJF/TF		CODE JP		
ltr	ecn no	dr	date	tolerances unless otherwise specified				mm 	title CAT NO. TABLE FOR 1mm SPACING CONNECTOR (Cat. No. SLW__R/S-5A7LF)			
A	J05-0079	H.T	2/18/05	angles	linear							
B	J06-0459	H.T	11/8/06					scale \times	dwg no JSA 96309 sheet 1 of 1 size A4			
				dr	<i>[Signature]</i> 11/8/06			type Product Customer Drawing				
				enrg	<i>[Signature]</i> 11/8/06							
				chr	<i>[Signature]</i> 11/9/06							
				appd	<i>[Signature]</i> 11/9/06							
sheet index	revision sheet	B	1					Rev. B				



FCIconnect.com

Copyright FCI.



n : NO. OF CONTACTS

1. THIS PRODUCT MEETS EUROPEAN UNION DIRECTIVES AND OTHER COUNTRY REGULATIONS AS DESCRIBED IN GS-22-008

2. THE HOUSING WILL WITHSTAND EXPOSURE TO 260°C PEAK TEMPERATURE FOR 10 SECONDS IN A WAVE SOLDER APPLICATION WITH A 1.6mm THICK CIRCUIT BOARD.

PT.NO.	PARTS NAME	MATERIAL	Q'TY	NOTE
1	HOUSING	NYLON RESIN GLASS REINFORCED (UL94V-0)	1	COLOR : BLACK
2	SLIDER		1	
3	CONTACT	PHOSPHOR BRONZE	n	PLATING : MATTE PURE TIN (LEAD FREE)

RECOMMENDED PC BOARD THICKNESS : 0.8~1.6 HOLE PATTERN (COMPONENT SIDE)

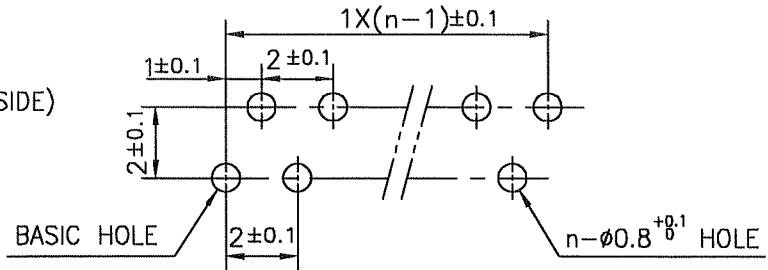

mat'l. code				surface ISO 1302 ✓		tolerance ISO 406 ISO 1101		projection		product family 58JF		CODE JP	
ltr	ecn no	dr	date	tolerances unless otherwise specified				mm		title			
A	J05-0079	H.T	2/18/05	± 0.3				mm		1mm SPACING CONNECTOR (Cat. No. SLW__S-5A7LF)			
B	J05-0734	H.T	10/28/05	angles linear				scale X		dwg no JSA 96310 sheet 1 of 1 size A4 type Product Customer Drawing			
C	J06-0459	H.T	11/8/06										
				dr				FCJ					
				engr									
				chr									
				appd									
sheet index		revision sheet		c								Rev. c	

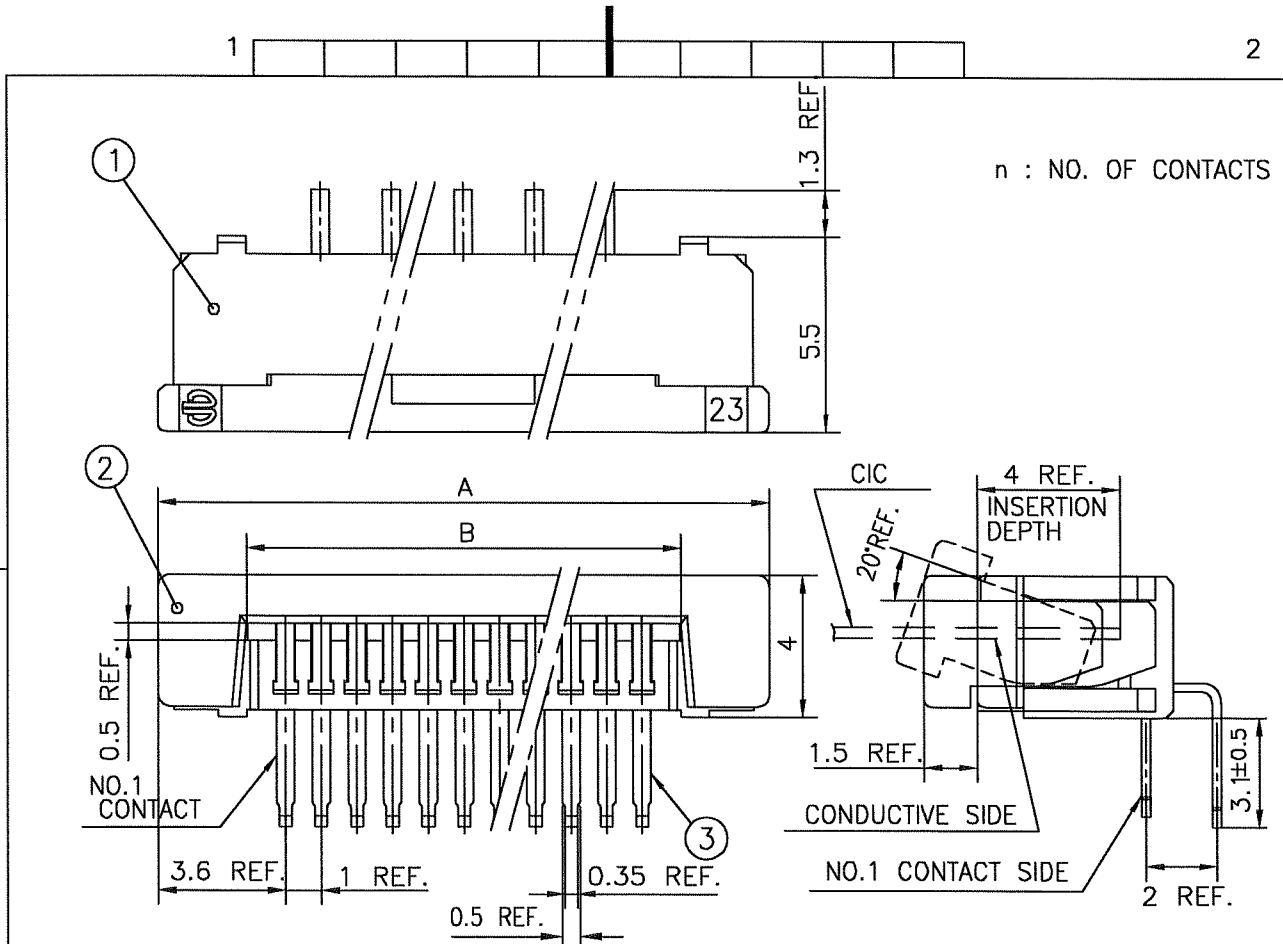

1. THIS PRODUCT MEETS EUROPEAN UNION DIRECTIVES AND OTHER COUNTRY REGULATIONS AS DESCRIBED IN GS-22-008

2. THE HOUSING WILL WITHSTAND EXPOSURE TO 260°C PEAK TEMPERATURE FOR 10 SECONDS IN A WAVE SOLDER APPLICATION WITH A 1.6mm THICK CIRCUIT BOARD.

PT.NO.	PARTS NAME	MATERIAL	Q'TY	NOTE
1	HOUSING	NYLON RESIN GLASS REINFORCED (UL94V-0)	1	COLOR : BLACK
2	SLIDER		1	
3	CONTACT	PHOSPHOR BRONZE	n	PLATING : MATTE PURE TIN (LEAD FREE)

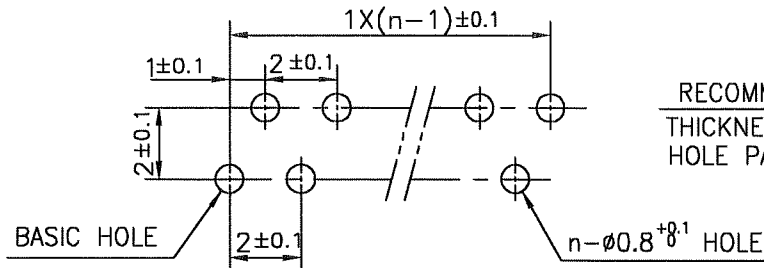

RECOMMENDED PC BOARD THICKNESS : 0.8~1.6 HOLE PATTERN (COMPONENT SIDE)

mat'l. code				surface ISO 1302 ✓		tolerance ISO 406 ISO 1101		projection		product family 58TF		CODE JP	
ltr	ecn no	dr	date	tolerances unless otherwise specified				mm		title			
A	J05-0079	H.T.	'05/2/18	angles		linear ±0.3		scale X		1mm SPACING CONNECTOR (Cat. No. SLW__R-5A7LF)			
B	J05-0734	H.T.	10/28/'05							dwg no sheet 1 of 1 size			
C	J06-0459	H.T.	11/8/'06							JSA 96311 A4			
				dr		11/01/06				type Product Customer Drawing			
				enr		11/01/06							
				chr		11/9/06							
				appd		11/9/06							
sheet index		revision sheet		C		1						Rev. C	

SC-SLW04 JSA96309 form: A4

RECOMMENDED CABLE (CIC)



PT. NO.	PARTS NAME	MATERIAL	THICKNESS (μm)	
1	BASE FILM	POLYESTER OR EQUAL	75	25
2	CONDUCTOR	CARBON PASTE OVER SILVER PASTE	10 MIN.	
3	OVERLAY	POLYIMIDE OR POLYESTER OR EQUAL	—	
4	SUPPORTING TAPE	POLYESTER OR POLYIMIDE OR EQUAL	188	250

NOTES

1. NO BURR AT EACH PORTION.
2. NO PEELING IN COMMON USE.
3. TOTAL THICKNESS LIMIT OF EACH MATERIAL (INCLUDING ADHESIVE AGENT) IS SPECIFIED.

mat'l. code				surface ISO 1302 ✓		tolerance ISO 406 ISO 1101		projection		product family 58JF/TF		CODE JP		
ltr	ecn no	dr	date	tolerances unless otherwise specified						title				
AA	J05-0079	H.T	2/18/05					mm		RECOMMENDED CABLE (Cat. No. SLW__R/S-5__)				
AB	J06-0459	H.T	11/8/06	angles	linear			scale X						
				dr	11/8/06				dwg no		sheet 1 of 1		size	
				enr	11/8/06				JSA 92759				A4	
				chr	11/9/06				type		Product Customer Drawing			
				appd	11/9/06									
sheet index		revision sheet		AB	1								Rev. AB	

Компания «Океан Электроники» предлагает заключение долгосрочных отношений при поставках импортных электронных компонентов на взаимовыгодных условиях!

Наши преимущества:

- Поставка оригинальных импортных электронных компонентов напрямую с производств Америки, Европы и Азии, а так же с крупнейших складов мира;
- Широкая линейка поставок активных и пассивных импортных электронных компонентов (более 30 млн. наименований);
- Поставка сложных, дефицитных, либо снятых с производства позиций;
- Оперативные сроки поставки под заказ (от 5 рабочих дней);
- Экспресс доставка в любую точку России;
- Помощь Конструкторского Отдела и консультации квалифицированных инженеров;
- Техническая поддержка проекта, помощь в подборе аналогов, поставка прототипов;
- Поставка электронных компонентов под контролем ВП;
- Система менеджмента качества сертифицирована по Международному стандарту ISO 9001;
- При необходимости вся продукция военного и аэрокосмического назначения проходит испытания и сертификацию в лаборатории (по согласованию с заказчиком);
- Поставка специализированных компонентов военного и аэрокосмического уровня качества (Xilinx, Altera, Analog Devices, Intersil, Interpoint, Microsemi, Actel, Aeroflex, Peregrine, VPT, Syfer, Eurofarad, Texas Instruments, MS Kennedy, Miteq, Cobham, E2V, MA-COM, Hittite, Mini-Circuits, General Dynamics и др.);

Компания «Океан Электроники» является официальным дистрибьютором и эксклюзивным представителем в России одного из крупнейших производителей разъемов военного и аэрокосмического назначения «JONHON», а так же официальным дистрибьютором и эксклюзивным представителем в России производителя высокотехнологичных и надежных решений для передачи СВЧ сигналов «FORSTAR».



JONHON

«JONHON» (основан в 1970 г.)

Разъемы специального, военного и аэрокосмического назначения:

(Применяются в военной, авиационной, аэрокосмической, морской, железнодорожной, горно- и нефтедобывающей отраслях промышленности)

«FORSTAR» (основан в 1998 г.)

ВЧ соединители, коаксиальные кабели, кабельные сборки и микроволновые компоненты:

(Применяются в телекоммуникациях гражданского и специального назначения, в средствах связи, РЛС, а так же военной, авиационной и аэрокосмической отраслях промышленности).



Телефон: 8 (812) 309-75-97 (многоканальный)

Факс: 8 (812) 320-03-32

Электронная почта: ocean@oceanchips.ru

Web: <http://oceanchips.ru/>

Адрес: 198099, г. Санкт-Петербург, ул. Калинина, д. 2, корп. 4, лит. А