

Industrial Automation Products

Master Selection Guide

PROXIMITY SENSORS



OTHER SENSOR SOLUTIONS

GENERAL PURPOSE RELAYS

POWER SUPPLIES



PUSHBUTTONS, SWITCHES AND PILOT DEVICES

PHOTOELECTRIC



LIMIT SWITCHES



TIMERS, COUNTERS AND PANEL METERS



AMPLIFIED PHOTOMICROPROCESORS

An Industry Leader Makes a Great Automation Partner

Trust your automation needs to Omron, a global leader and innovator in industrial automation controls and systems. Your investment in Omron systems and training repays itself quickly with improved productivity, continued profitability and competitive manufacturing advantage.

What Makes Omron Different?

Quality

- All products 100% quality-tested before shipping
- Designed and manufactured to the highest ISO 9001, IPC and JIS standards

Stability

- Over 70 years in the controls business, founded in 1933
- \$6 billion USD global technology leader
- 40% of business comes from industrial automation; social systems, electronic components, automotive components and healthcare make up the balance

Technology

- 7% of sales reinvested annually in R&D ensures leading edge solutions that improve our customers' productivity and profits
- Products offer security features to prevent tampering

Ease of use

- Simple menus enable quick setup, operation and changeover for controllers, inspection systems and communications
- Helpful software tools provide data tracking and production monitoring
- One software package programs all Omron PLCs

Flexibility

- More than 300,000 products help you design a complete automation solution from one source
- Easy forward/backward migration maintains the value of your automation investment

Support

- Global, regional and local support in 65 countries through 1,500 offices
- Documentation available on-line
- Training, phone support, 24/7 emergency services give you peace of mind

Contents

Photoelectric Sensors	1
Amplified Photomicrosensors	14
Proximity Sensors	18
Limit Switches	24
Other Sensors.....	27
Pressure Sensors.....	28
Encoders	30
Ultrasonic Sensors.....	32
Pushbuttons, Switches and Pilot Devices	33
Power Supplies.....	36
Timers, Counters, Digital Panel Meters	38
Timers	39
Counters.....	41
Digital Panel Meters	42
Terms and Conditions of Sales.....	44

Omron Delivers End-to-End Automation from a Single Source

Our large global installed base of plant automation solutions combine sensors, programmable controllers, human machine interface terminals, RFID and other track-and-trace code readers, motion control and products to complete control panel installation.

Only the Best Products

This Master Selection Guide contains our latest and most popular products, and represents a fraction of what is available.

For More Information...

Internet

Visit www.components.omron.com

For Data sheets and technical bulletins call phone number below.

Phone

Call us: **847.882.2288** Monday through Friday, 7:30 AM to 6:00 PM Central Time for more detailed product information, the location of your local sales office or Omron distributor.

email: components@omron.com

Photoelectric Sensors

Omron Smart Solutions

E3Z-B



Accurately detect PET bottles and transparent material. Omron offers sensors to solve many packaging-related problems.

Save space with two fiber-optic amplifiers in a slim body; it offers large digital display and one-button teaching; over 100 sensing head/cables available.

E3T



Subminiature low-cost sensor with built-in amplifier detects positioning and presence/absence in space-confined installations.

Rugged IP67-rated diffuse sensor detects objects of any color, texture or glossiness from any direction using programmable foreground and background suppression.

E3X-MDA



E3NT

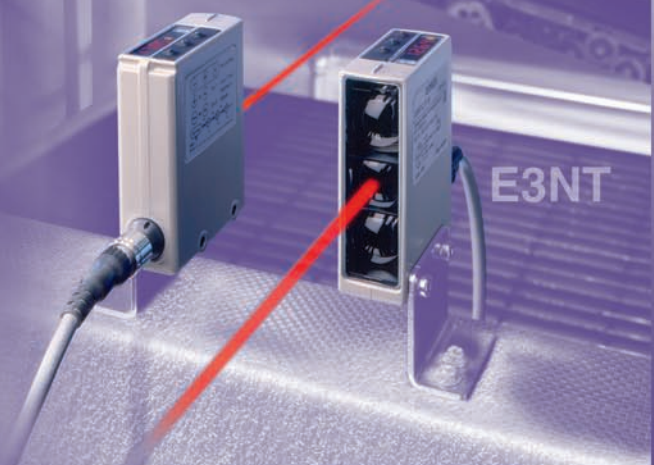

PHOTOELECTRIC SENSORS



E3Z

E3Z-LS

E3Z-B

E3T

	E3Z	E3Z-LS	E3Z-B	E3T
Dimensions mm (in)	31 H x 10.8 W x 20 D (1.22 x 0.43 X 0.79)	31 H x 10.8 W x 20 D (1.22 x 0.43 x 0.79)	31 H x 10.8 W x 20 D (1.22 x 0.43 x 0.79)	19 H x 12 W x 4 D (0.74 x 0.47 x 0.15)
Amplifier type	Built-in DC amplifier	Built-in DC amplifier	Built-in DC amplifier	Built-in DC amplifier
Features	<ul style="list-style-type: none"> • Sub-miniature sensor offers long sensing distances and high noise immunity • IP67 rated • Connector models available 	<ul style="list-style-type: none"> • Foreground/background suppression • Pre-wired 2 m cable or M8 connector • Distance settable • Stable sensing regardless of target's color 	<ul style="list-style-type: none"> • Detects PET bottles 	<ul style="list-style-type: none"> • Micro-miniature space saving • Watertight IP67 • Pinpoint beam for detection of extremely small targets • 1 meter range • Hyper LED smallest visible red LED • Flat and rectangular body styles • CE conformance
Through-beam sensing distance	15 m (49.2 ft)	–	–	1 m (3.28 ft)
Retroreflective sensing distance	4 m (13.12 ft)	–	500 mm – 2 m depends on reflector	Polarized: 200 mm (7.88 in)
Diffuse reflective sensing distance	1 m (3.28 ft) or 5 to 100 mm (0.2 to 3.94 in)	20 mm to 200 mm (BGS) 40 mm to 200 mm (FGS)	–	30 mm (1.18 in) 15 mm on certain convergent beam models
Color sensing	–	–	–	–
Supply voltage	12 to 24 VDC	12 to 24 VDC	12 to 24 VDC	12 to 24 VDC
AC control output	–	–	–	–
DC control output type	NPN or PNP	NPN or PNP	NPN or PNP	NPN or PNP
Max. load	100 mA	100 mA max.	100 mA max.	50 mA max. at 24 VDC
Alarm	–	–	–	–
Response time	1 ms max.	Operation or reset: 1 ms max.	Operation or reset: 1 ms max.	2 ms ON/OFF
Materials:				
Lens	Denatured polyallylate	Denatured polyallylate	Denatured polyallylate	Polycarbonate
Case	PBT plastic	PBT plastic	PBT plastic	PBT plastic
Bracket	–	–	–	–
Cover	–	–	–	Polycarbonate
Enclosure rating	IP67, 1200 PSI (NEMA ICS5, ANNEXF)	IEC 60529 IP67, 1200 PSI (NEMA ICS5, ANNEXF)	IEC 60529 IP67, 1200 PSI (NEMA ICS5, ANNEXF)	IP67
Light source	Pulse modulated infrared LED (860 nm) or visible red LED (680 nm)	Red LED (680 nm)	Red LED (680 nm)	Red "Pin Point" LED (670 nm)
Circuit protection	Load short circuit and reverse polarity	Reverse polarity, output short-circuit	Reverse polarity, output short-circuit	Load short circuit and reverse polarity
Mutual interference protection	On all except through-beam models	Yes	Yes	On all except through-beam models
Operation mode	Light-ON / Dark-ON switch selectable	Light-ON / Dark-ON switch selectable	Light-ON / Dark-ON switch selectable	Light-ON / Dark-ON separate models
Applications	General purpose sensing; Sub-miniature, long detection distances, noise immunity; IP67 rated; CE approved	General purpose; Material handling; Packaging; Background suppression	PET bottles and transparent objects	Flat or rectangular micro- miniature package; Washdown environments; Pinpoint beam for extremely small target detection; CE conformance; Latest generation technologies

PHOTOELECTRIC SENSORS







E3NT

E3F2

E3G-L1/L3

E3S-A

	E3NT	E3F2	E3G-L1/L3	E3S-A
Dimensions mm (in)	88.7 H x 27 W x 65.1 D (3.49 x 1.06 x 2.56)	18.5 dia. x 65 L (0.73 x 2.56)	40 H x 18.4 W x 27 D (1.57 x 0.72 x 1.06)	22.3 H x 12.4 W x 44 or 50 D (0.88 x 0.49 x 1.73 or 1.97)
Amplifier type	Built-in DC amplifier	Built-in AC or DC amplifier	Built-in DC amplifier	Built-in DC amplifier
Features	<ul style="list-style-type: none"> • Programmable BGS/FGS diffuse sensor • Digital, software configurable • Detects any color, texture, or glossiness from any direction • Double-triangulated optics • Rugged housing withstands extreme environment 	<ul style="list-style-type: none"> • Rugged stainless, nickel plate brass, and plastic models are chemical resistant • Wide operating voltage range • AC/DC • UL, CSA, CE certified • Connector models available 	<ul style="list-style-type: none"> • Distance settable pinpoint beam • TEACH mode for reliable detection of minute objects any color, material, or glossiness • IP67; NEMA 4; CE approved 	<ul style="list-style-type: none"> • Fast response time • Selectable Light-ON / Dark-ON operation • Alarm output indicates deteriorating sensing conditions • Timer versions available
Through-beam sensing distance	–	To 7 m (22.97 ft)	–	7 m (23 ft)
Retroreflective sensing distance	–	To 2 m (6.56 ft)	–	Polarized: 0.1 to 2 m (0.33 to 6.56 ft)
Diffuse reflective sensing distance	0.2 m to 2 m	To 300 mm (11.81 in)	5 to 200 mm (0.19 to 7.87 in)	0 to 100 mm (0 to 3.94 in) 10 to 200 mm (0.04 to 7.87 in) 0 to 700 mm (0 to 27.56 in)
Color sensing	–	–	–	–
Supply voltage	10 to 30 VDC	24 to 240 VAC 50/60 Hz. or 10 to 30 VDC	10 to 30 VDC	10 to 30 VDC
AC control output	–	SCR 200 mA max.	–	–
DC control output type	NPN or PNP or complementary	NPN/PNP separate models	NPN or PNP	NPN or PNP
Max. load	100 mA max.	100 mA max. at 30 VDC	100 mA max. at 30 VDC	100 mA max. at 30 VDC
Alarm	Yes	–	–	50 mA max. NPN/PNP
Response time	≤ 2.5 ms	30 ms AC models; 2.5 ms DC models	1.5 ms or 2.5 ms model dependent	0.5 ms max.
Materials:				
Lens	Housing: Powder-coated aluminum	Plastic	Acrylic (PMMA)	Denatured polyarylate
Case	Front pane: Glass	ABS or nickel-plated brass or stainless steel	PBT plastic	PBT plastic
Bracket	Keyboard: HTV silicone	–	Stainless steel 304	Stainless steel
Cover	Seals: RTV silicone	–	–	–
Enclosure rating	IP67 (EN 60529/IEC 529)	NEMA 1, 2, 4 (indoor) IP66 AC models; IP67 NEMA 6 Metal versions, IP66 NEMA 4 Plastic	IP67 NEMA 4	NEMA 4X, 6, IP67
Light source	Infrared LED (850-880 nm)	Infrared LED or Red LED	Infrared LED (860 nm) or red LED (670 nm)	Pulse modulated red and infrared LED
Circuit protection	Reverse polarity, overload, short-circuit	Reverse polarity, short circuit on DC power supply models only	Short-circuit, reverse polarity	Load short circuit and reverse polarity
Mutual interference protection	Yes	–	Yes	On all except through-beam models
Operation mode	Light-ON / Dark-ON programmable	Light-ON / Dark-ON selectable with control wire	Light-ON / Dark-ON switch selectable	Light-ON / Dark-ON switch selectable
Applications	Extreme conditions; Food & Beverage; Packaging; Material Handling; Car wash	General purpose sensing; Chemical resistant ABS version; Stainless or nickel-plated brass versions; Connector types; Cylindrical design; M18 mounting	Food and Bev, material handling, packaging applications; Multiple object detection	General purpose sensing; Washdown environment; Miniature size; High speed sensing 0.5 ms; Timers, vertical or horizontal mount versions

PHOTOELECTRIC SENSORS				
				
	E3X-DAN/DAB	E3X-DA-S	E3X-MDA	E3X-NA
Dimensions mm (in)	31.5 H x 10 W x 64.3 D (1.24 x 0.39 x 2.53)	32 H x 10 W x 70 D (1.26 x 0.39 x 2.75)	32 H x 10 W x 70 D (1.26 x 0.39 x 2.75)	-NA□□, -NA□□F, -NAG□□: 31.5 H x 10 W x 64.3 D (1.24 x 0.39 x 2.53) -NA□□V: 33 H x 12 W x 81.5 D (1.29 x 0.47 x 3.21)
Amplifier type	All purpose fiber-optic amplifier	All purpose fiber-optic amplifier	All purpose fiber-optic amplifier	Fiber-optic amplifier
Features	<ul style="list-style-type: none"> User selectable displays: digital, percentage and analog display Available in digital or dual analog/digital output Digital display can be read right-side-up regardless of amplifier orientation 	<ul style="list-style-type: none"> Power tuning Dual digital display 4 element LED 2 independent outputs Counter function 	<ul style="list-style-type: none"> Power tuning Dual digital display 4 element LED 2 channel amplifier AND/OR control output 	<ul style="list-style-type: none"> Master/slave connector design affords connectivity up to 16 amplifiers Wire saving amplifiers reduce installation time and minimize space requirements LED bar display Mutual interference protection Excellent response time M8 connector ready models and water resistant models
Through-beam sensing distance	Varies depending on the model and fiber chosen	Varies depending on the model and fiber chosen	Varies depending on the model and fiber chosen	Varies depending on the model and fiber chosen
Retroreflective sensing distance	Varies depending on the model and fiber chosen	Varies depending on the model and fiber chosen	Varies depending on the model and fiber chosen	Varies depending on the model and fiber chosen
Diffuse reflective sensing distance	Varies depending on the model and fiber chosen	Varies depending on the model and fiber chosen	Varies depending on the model and fiber chosen	Varies depending on the model and fiber chosen
Color sensing	Yes	Yes	Yes	Yes (E3X-NAG11/NAG41)
Supply voltage	12 to 24 VDC	12 to 24 VDC ±10%, Ripple (P-P) 10% max.	12 to 24 VDC ±10%, Ripple (P-P) 10% max.	12 to 24 VDC
AC control output	–	–	–	–
DC control output type	NPN or PNP	NPN or PNP	NPN or PNP	NPN or PNP
Max. load	50 mA max.	50 mA max.	50 mA max.	50 mA max.
Alarm	–	–	–	–
Response time	Standard mode: 1 ms High-speed mode: 250 μs Long-distance mode: 4 ms	48 μs	Standard mode: 1 ms	-NA□□, -NA□□V, -NAG□□: 200 μs; -NA□□F: 50 μs
Materials:				
Lens	–	–	–	–
Case	PBT plastic	PBT plastic	PBT plastic	PBT plastic
Bracket	–	–	–	–
Cover	Polycarbonate	Polycarbonate	Polycarbonate	Polycarbonate (-NA□□) Polyethersulfone (E3X-NA□□V)
Enclosure rating	IP50/IP66	IP50	IP50	-NA□□, -NA□□F, -NAG□□: IP50; -NA□□V: IP66
Light source	Red LED	Red, green and blue LEDs available	Red LED	-NA□□, -NA□□V, -NA□□F: Red LED; -NAG□□: Green LED
Circuit protection	Short circuit, Reverse polarity	Short circuit, reverse polarity	Short circuit, reverse polarity	Reverse polarity; Output short-circuit; Mutual interference; -NA□□F: Reverse polarity; Output short-circuit
Mutual interference protection	Yes	Yes	Yes	Yes
Operation mode	Light-ON / Dark-ON switch selectable	Light-ON / Dark-ON switch selectable	Light-ON / Dark-ON selectable	Light-ON / Dark-ON (switch selectable)
Applications	All purpose, high speed, mark sensing, transparency detection, color discrimination, delicate level difference, minute object, high-precision positioning	All purpose, high speed, mark sensing, transparency detection, color discrimination, delicate level difference, minute object, high-precision positioning	All purpose, high speed, mark sensing	General purpose, high speed, mark sensing

Over 100 Fiber-Optic Sensor Cables

One exactly matches your requirements

Constant Flexing Applications

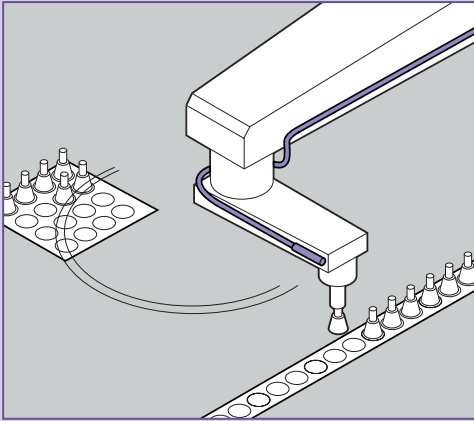

The special construction of these fiber-optic cables resists breaking and enables them to withstand the punishing effects of constant flexing or tight bending. The stranded fiber core can be bent to a radius as small as 4 mm with no loss in light intensity. They are ideal for use on moving and articulating equipment such as robotic arms.

AVAILABLE MODELS



Through-Beam

- E32-T11 (680 mm sensing distance, M4 threaded head)
- E32-T21 (200 mm sensing distance, M3 threaded head)
- E32-T22B (200 mm sensing distance, 1.5 mm dia. head)

Diffuse

- E32-D11 (170 mm sensing distance, M6 threaded head)
- E32-D21 (30 mm sensing distance, M3 threaded head)
- E32-D21B (70 mm sensing distance, M4 threaded head)
- E32-D22B (30 mm sensing distance, 1.5 mm dia. head)

Chemical Resistant Applications

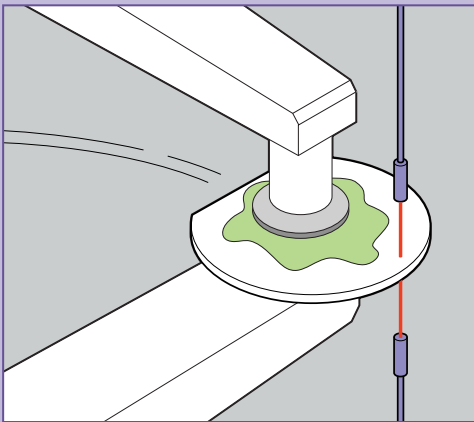

Teflon[®] coated fiber optic cables provide long lasting reliability in sensing environments where corrosive fluids and gasses are present. They are designed for use where strong chemicals are manufactured or being used for processing or cleaning.

AVAILABLE MODELS



Through-Beam

- E32-T11F (2000 mm sensing distance, 7.2 mm dia. head)
- E32-T12 F (3000 mm sensing distance, 5 mm dia. head)
- E32-T14F (400 mm sensing distance, 5 mm dia., side view head)
- E32-T81F-S (700 mm sensing distance, 6 mm dia. head, to 200°C)

Diffuse

- E32-D12F (95 mm sensing distance, 6 mm dia. head)

High Temperature Applications

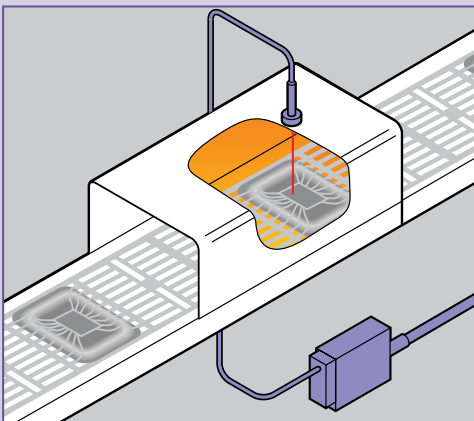

Omron offers a variety of heat resistant fiber optic cables that can operate reliably in temperatures up to 400°C (752°F). The fluororesin and armored stainless steel sheaths protect the fibers for use in ovens and other high heat applications.

AVAILABLE MODELS



Through-Beam

- E32-T51 (760 mm sensing distance, M4 threaded head, to 150°C)
- E32-T54 (230 mm sensing distance, 2 mm dia., side view head, to 150°C)
- E32-T61-S (450 mm sensing distance, M4 threaded head, stainless steel sheath, to 350°C)
- E32-T84S-S (1300 mm sensing distance, 3 mm dia. L-shaped head, to 200°C)

Diffuse

- E32-D51 (230 mm sensing distance, M6 threaded head, to 150°C)
- E32-D61-S (90 mm sensing distance, M6 threaded heads, stainless steel sheath, to 350°C)
- E32-D73-S (60 mm sensing distance, M4 threaded head, stainless steel probe, to 400°C)
- E32-D81R-S (90 mm sensing distance, M6 threaded head, to 200°C)

Wide Area Sensing Applications

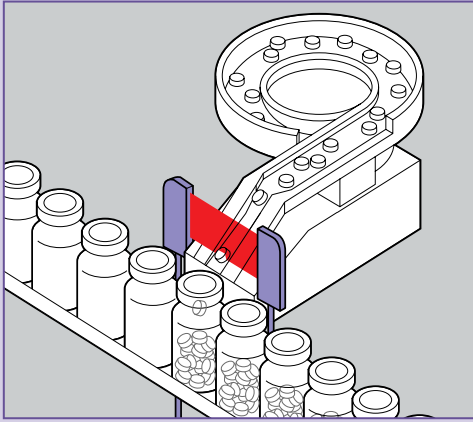

Applications that require a larger target area for sensing small, randomly positioned objects are ideal for Omron's wide area sensing fiber optic cables. They project a wide plane of light that can detect very small objects anywhere within the width of the beam. Use them for detecting pills in packaging and similar applications.

AVAILABLE MODELS



Through-Beam

- E32-M21 (610 mm sensing distance, four M3 heads)
- E32-T16 (2800 mm sensing distance, 10 mm wide beam)
- E32-T16P (1100 mm sensing distance, 11 mm wide beam)
- E32-T16W (1800 mm sensing distance, 30 mm wide beam)
- E32-T16J (1000 mm sensing distance, 11 mm wide beam, side view)

Diffuse

- E32-D36P1 (100 mm sensing distance, 10.85 mm wide beam)

Precise Positioning Applications

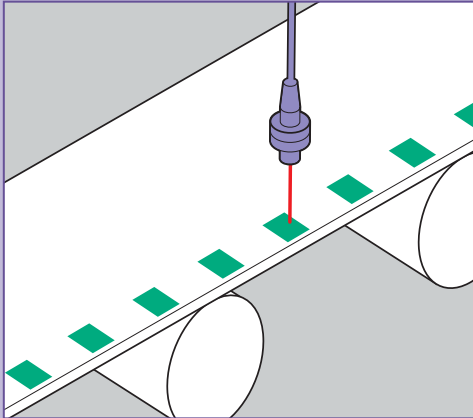

When it is critical to position objects or machinery accurately and consistently, Omron provides a solution with a unique coaxial cable design that surrounds the light emitting fiber with light detection fibers.

AVAILABLE MODELS

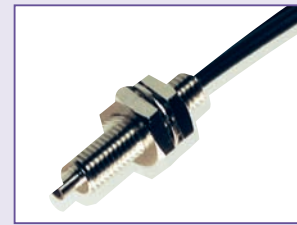

Diffuse

- E32-CC200 (300 mm sensing distance, M6 threaded head, 16 receivers)
- E32-D32L (150 mm sensing distance, 3 mm dia. head, 16 receivers)
- E32-D32 (75 mm sensing distance, 2 mm dia. head, 4 receivers)
- E32-C31 (75 mm sensing distance, M3 threaded head, 4 receivers)
- E32-C41 (35 mm range, M3 threaded head, 6 receivers)
- E32-C42 (35 mm range, 2 mm dia. head, 6 receivers)

Detect Minute Objects

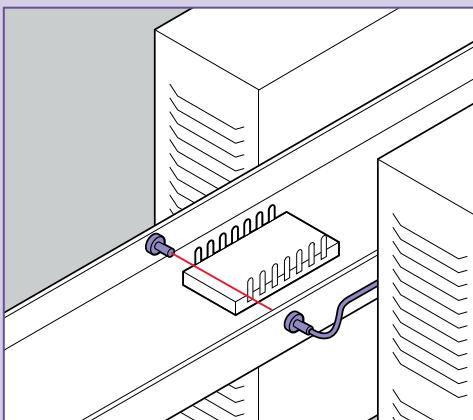

Detect extremely small objects, as small as 0.5 mm, in very space-restricted areas. Most are available with bendable "probe" tips that let you mount the head away from the detection area and bend the probe tip to the precise sensing area.

AVAILABLE MODELS



Through-Beam

- E32-T22 (220 mm sensing distance, 2 mm dia. head)
- E32-TC200B (760 mm sensing distance, 1.2 mm dia. head, probe tip)
- E32-TC200E (220 mm sensing distance, M3 threaded head)
- E32-TC200F (220 mm sensing distance, 0.9 mm dia. head, probe tip)

Diffuse

- E32-DC200B (300 mm sensing distance, 2.5 mm dia. head, probe tip)
- E32-DC200E (80 mm sensing distance, M3 threaded head)
- E32-DC200F (80 mm sensing distance, 1.2 mm dia. head, probe tip)
- E32-D33 (16 mm sensing distance, 0.8 mm dia. head, probe tip)
- E32-D331 (3 mm sensing distance, 0.5 mm dia. head, probe tip)

Background Suppression Applications

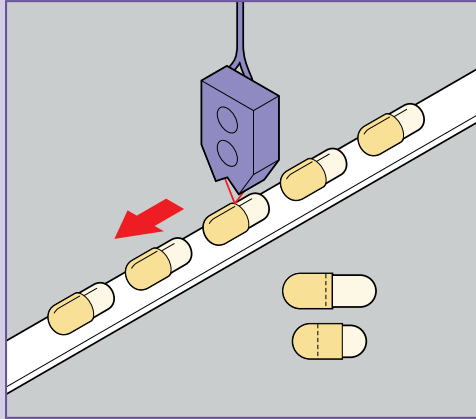

Fiber optic cables with convergent beam head configurations solve the problem of background reflections in space-restricted areas. These special cables can also be used for precise positioning of objects or machinery. Left- and right-side emitter models eliminate interference when using two or more E32-L56 sensing heads.

AVAILABLE MODELS



Convergent Beam

- E32-L24L (4±2 mm range, side view head, to 105°C)
- E32-L24S (0-4 mm range, side view head)
- E32-L25 (3.3 mm range, side view head)
- E32-L25L (7.2±1.8 mm range)
- E32-L25A (3.3 mm range)
- E32-L56E□ (4-12 mm range)
- E32-L66 (5-18 mm range, sensing head to 300°C)

Long Range Detection of Small Objects

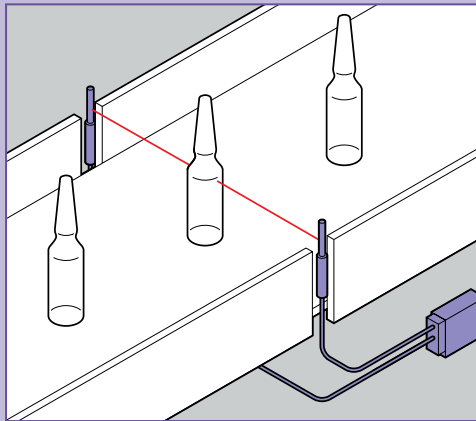

A wide variety of fiber optic cables with special sensing heads and lenses are available for detecting small objects over longer distances in space-confined areas. They are available in through-beam or diffuse versions with threaded and non-threaded heads for more versatile mounting.

AVAILABLE MODELS



Through-Beam

- E32-T11L (1330 mm sensing distance, M4 threaded head)
- E32-T12L (1330 mm sensing distance, 3 mm dia. head)
- E32-T14L (460 mm sensing distance, 3 mm dia., side view head)
- E32-T17L (20,000 mm sensing distance, M14 threaded head)
- E32-T21L (440 mm sensing distance, M3 threaded head)
- E32-T22L (440 mm sensing distance, 2 mm dia. head)

Diffuse

- E32-D11L (400 mm sensing distance, M6 threaded head)
- E32-D12 (230 mm sensing distance, 3 mm dia. head)
- E32-D16 (40 to 700 mm sensing distance, 17.5 mm square head)
- E32-D21L (130 mm sensing distance, M4 threaded head)
- E32-D22L (130 mm sensing distance, 3 mm dia. head)

Fluid Level Detection

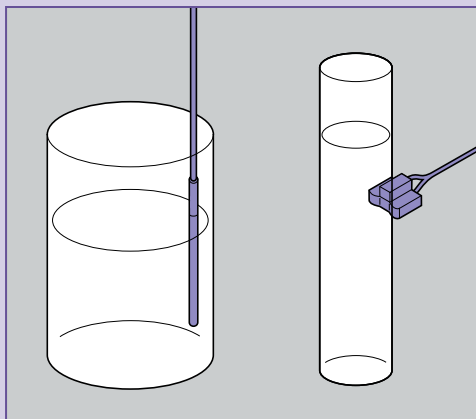

Omron offers two fiber optic sensing solutions for fluid level detection in space-confined areas: immersion style sensing heads can be submerged in the fluid to be monitored, and a tube-mounted sensing heads that can sense fluids through a clear tube.

AVAILABLE MODELS



- E32-D82F1 (Immersion type, 150 mm length)
- E32-D82F2 (Immersion type, 350 mm length)
- E32-A01 (External mount; 3.2, 6.4, 9.5 mm clear tube)
- E32-A02 (External mount; 6 to 13 mm clear tube)
- E32-L25T (External mount, 8 to 10 mm clear tube)
- E32-D36F (External mount; clear tube, no diameter restriction)

Also consider EE-SPX613 Amplified Photomicrosensor

Transparent Object Detection

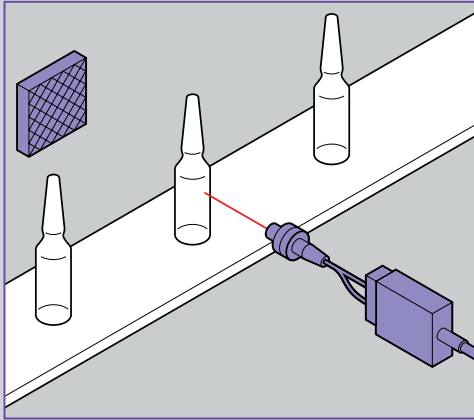

Sensing transparent objects is always a challenge. Omron solves this problem with fiber optic cables that are polarized and reflectors specially designed for sensing small transparent objects in tight spaces. They are ideal for sensing lenses, clear plastics, and transparent packaging materials.

AVAILABLE MODELS



E32-R21 (Retroreflective, 10–250 mm range)
E32-R16 (Retroreflective, 150–1,500 mm range)

Extreme Bending Applications

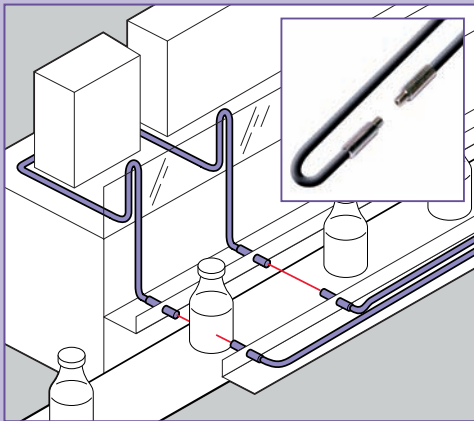

For machine applications that require extreme bending of fiber optic cables to conform to tight spaces, Omron offers a variety of cables that feature a unique multi-core construction. Unlike single-core cables that can lose their light transmission capability when bent tightly, the multi-core design ensures optimal light transmission even when bent 180° with a bending radius of 1 mm.

AVAILABLE MODELS

Through Beam

- E32-T11R (530 mm sensing distance, M4 threaded head)
- E32-T12R (530 mm sensing distance, 3 mm dia. head)
- E32-T14LR (210 mm sensing distance, 3 mm dia. head)
- E32-T21R (130 mm sensing distance, M3 threaded head)
- E32-T16WR (1300 mm sensing distance, 30 mm wide beam)
- E32-T16JR (750 mm sensing distance, 11 mm wide beam, side view)
- E32-T16PR (840 mm sensing distance, 11 mm wide beam)
- E32-T22R (130 mm sensing distance, 2 mm dia. head)
- E32-T24R (50 mm sensing distance, 1 mm dia. head, side view)

Diffuse

- E32-D11R (170 mm sensing distance, M6 threaded head)
- E32-D12R (170 mm sensing distance, 3 mm dia. head)
- E32-D14LR (45 mm sensing distance, 6 mm dia. head, side view)
- E32-D21R (30 mm sensing distance, M3 threaded head)
- E32-D22R (30 mm sensing distance, 3 mm dia. head)
- E32-D24R (15 mm sensing distance, 2 mm dia. head, side view)

General-Purpose Industrial Applications

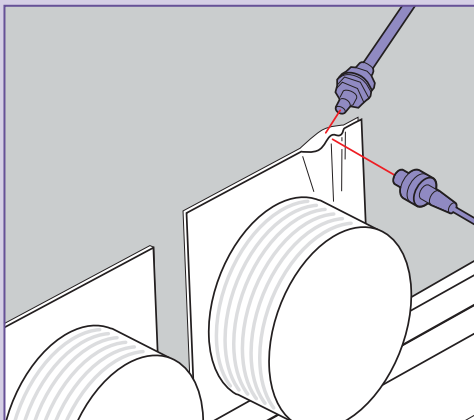

For most sensing applications, the space-saving combination of a fiber-optic amplifier and general-purpose fiber unit provides an economical solution.

AVAILABLE MODELS



Through-Beam

- E32-TC200 (760 mm sensing distance, M4 threaded head)
- E32-TC200A (680 mm sensing distance, M3 threaded head)

Diffuse

- E32-DC200 (300 mm sensing distance, M6 threaded head)

PHOTOELECTRIC SENSORS







E3XA analog fiber-optic amplifier

E3S-CL

E3JK

E3JM

Dimensions mm (in)	40 H x 20.4 W x 30 D (1.57 x 0.80 x 1.18)	42.6 H x 15.5 W x 40 D (1.7 x 0.61 x 1.57)	50 H x 17.6 W x 50 D (1.97 x 0.69 x 1.97)	65 H x 25 W x 75 D (2.56 x 0.98 x 2.95)
Amplifier type	Fiber-optic amplifier	Built-in amplifier	Built-in AC/DC amplifier	Built-in AC/DC amplifier
Features	<ul style="list-style-type: none"> • Ideal for detecting size, color and surface characteristics • Four turn controls allow fine adjustment of sensitivity and operating point 	<ul style="list-style-type: none"> • Background suppression • Stable detection regardless of material color or size of object • Sensing unaffected by dirty lens • IP67 water resistant housing 	<ul style="list-style-type: none"> • Complimentary relay output 1NO & 1NC or NPN/PNP • Slim housing ideal for narrow installation spaces • Universal AC/DC supply voltage 	<ul style="list-style-type: none"> • Relay or transistor output available • Built-in timers available • Easy to wire terminal block • Universal AC/DC supply voltage
Through-beam sensing distance	Varies depending on the model and fiber chosen	–	5 m (16.4 ft)	10 m (32.8 ft)
Retroreflective sensing distance	Varies depending on the model and fiber chosen	–	0 to 3 m (9.8 ft) 0 to 5 m (16.4 ft)	Polarized 0 to 4 m (13.1 ft)
Diffuse reflective sensing distance	Varies depending on the model and fiber chosen	E3S-CL1: 5 to 200 mm E3S-CL2: 5 to 500 mm	0 to 300 mm (11.8 in)	0 to 700 mm (2.3 ft)
Color sensing	Yes	–	–	–
Supply voltage	12 to 24 VDC	10 to 30 VDC	24 to 240 VAC 50/60 Hz. and 12 to 240 VDC	24 to 240 VAC 50/60 Hz. and 12 to 240 VDC
AC control output	4 to 20 mA	–	Relay 3 A, 250 VAC	Relay 3 A, 250 VAC
DC control output type	NPN	NPN or PNP (switch selectable)	NPN/PNP wire selectable	NPN or PNP separate models
Max. load	Analog: 20 to 21.55 mA Digital: 100 mA max.	100 mA max.	100 mA at 300 VDC	100 mA at 48 VDC
Alarm	–	–	–	–
Response time	2 ms max. ON/OFF	2 ms max ON/OFF	30 ms relay output; 3 ms for transistor output	30 ms relay output; 5 ms for transistor output
Materials:				
Lens	Plastic	Acrylic	Plastic PMMA	Plastic PMMA
Case	Plastic	Zinc die cast	Plastic ABS	Plastic ABS
Bracket	–	Operating Panel: Sulfonated polyether	–	–
Cover	–	Stainless Steel	Plastic PMMA	Plastic PMMA
Enclosure rating	IP66	IP67	NEMA 1, 2, 12, IP64	IP66
Light source	Red LED	E3S-CL1: Red LED; E3S-CL2: IR LED	Pulse modulated infrared LED; Pulse modulated red LED	Infrared LED; Polarized red LED on retro
Circuit protection	Short-circuit, reverse polarity	Short-circuit, reverse polarity	Reverse polarity on DC power supply only	Load short circuit on transistor output models only
Mutual interference protection	–	Yes	–	–
Operation mode	Light-ON / Dark-ON switch selectable	Light-ON / Dark-ON switch selectable	Light-ON / Dark-ON separate models	Light-ON / Dark-ON switch selectable
Applications	Food and Bev, material handling, semiconductor, electronics packaging applications	Food and Bev, material handling, packaging applications, rugged applications	Relay or transistor output; Detect shiny objects; Universal supply AC/DC	UL CSA; Easy to wire terminal block; Relay or transistor output models available; Built-in timers available; Universal supply AC/DC

PHOTOELECTRIC SENSORS				
				
	E3L	E3HT	E3X-NT/NM	E3X-NL
Dimensions mm (in)	55 H x 17 W x 50 D (2.17 x 0.67 x 1.97)	8.5 dia. x 41.5 L (0.33 x 1.63)	Single Channel: 32.5 H x 10 W x 59 D (1.28 x 0.39 x 2.32) Four Channel: 32.5 H x 32.2 W x 59 D (1.28 x 1.27 x 2.32)	Amplifier: 33 H x 32.2 W x 59 D (1.29 x 1.27 x 2.32) Sensing Head (short): 29 H x 10.4 W x 29 D (1.14 x 0.41 x 1.14) (long): 42 H x 20.4 W x 47 D (1.65 x 0.80 x 1.85)
Amplifier type	Built-in DC amplifier	Built-in DC amplifier	Fiber-optic amplifier	Fiber-optic amplifier
Features	<ul style="list-style-type: none"> Laser beam provides long distance spot sensing Class 1 versions require no additional protection Stability indicator signals upon deteriorating conditions 	<ul style="list-style-type: none"> Ideal for space-confined installation 8 mm housing Cost effective Nickel plate brass construction CE certified Connector models available 	<ul style="list-style-type: none"> Remote teach function Four fiber-optic cables can be mounted directly next to each other without mutual interference 	<ul style="list-style-type: none"> Ideal for sensing glossy objects Easy-to-use TEACH function Remote TEACH function Mutual interference protection
Through-beam sensing distance	10 m (32.8 ft) 2 m (6.56 ft)	To 1 m (3.28 ft)	Varies depending on the model and fiber chosen	–
Retroreflective sensing distance	–	–	Varies depending on the model and fiber chosen	–
Diffuse reflective sensing distance	200 to 500 mm (7.90 to 19.7 in)	To 35 mm (1.38 in)	Varies depending on the model and fiber chosen	Short range: 10 ±3 mm Long range: 20 ±7 mm
Color sensing	–	–	–	–
Supply voltage	12 to 24 VDC	12 to 24 VDC	12 to 24 VDC	12 to 24 VDC
AC control output	–	–	–	–
DC control output type	NPN open collector or NPN constant current source or PNP open collector	NPN & TTL logic	NPN, PNP	NPN
Max. load	NPN 100 mA; NPN type: Load (relay, sink) logic: 80 mA Voltage (source) logic: 3 mA PNP type: Load (relay, source) logic: 80 mA	Relay (sink) 80 mA max.	100 mA max. at 30 VDC 100 mA max. at 40 VDC (E3X-VG)	100 mA
Alarm	NPN or PNP 50 mA at 24 VDC.	–	–	–
Response time	1 ms ON/OFF or 3 ms ON/OFF	10 ms ON/OFF through-beams; 6 ms ON/OFF diffuse models	500 µs	1 ms max.
Materials:	Lens Plastic (PMMA) Case Zinc die cast Bracket – Cover –	Plastic Nickel-plated brass – –	– PBT plastic – Polycarbonate	– PBT plastic – Polycarbonate
Enclosure rating	NEMA 4, IP67	NEMA 1, 3, 4X, 6, 12 IP66	IP50	IP50
Light source	Infrared pulse modulated laser diode (780 nm) or visible red pulse modulated laser diode (670 nm)	Pulse modulated infrared LED	Pulse modulated red LED	Red LED
Circuit protection	Load short circuit and reverse polarity	Reverse polarity and load short circuit	Short circuit and reverse polarity	–
Mutual interference protection	Standard level	–	Provided	Yes
Operation mode	Light-ON / Dark-ON wire selectable	Light-ON / Dark-ON separate models	Light-ON / Dark-ON switch selectable	Light-ON / Dark-ON switch selectable
Applications	Laser Photoelectric Prewired Sensor; Provides long distance detection of objects down to 0.1 mm dia.	CE certified; 8 mm cylindrical housing fits in compact spaces; Connector types available; Dual output NPN & TTL	General purpose, background suppression	Luster detection, tight space application

PHOTOELECTRIC SENSORS







E3S-C



E3S-CR

E3M-C

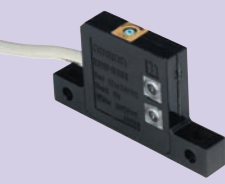
E3M-V

Dimensions mm (in)	Horizontal: 23 H x 20.4 W x 57.5 D (0.91 x 0.80 x 2.24) Vertical: 57.5 H x 20.4 W x 23 D (2.24 x 0.80 x 0.91)	Horizontal: 57 H x 20.4 W x 23 D (2.24 x 0.80 x 0.91)	53.2 H x 30.4 W x 98 D (2.09 x 1.19 x 3.85)	68.5 H x 21 W x 47.7 D (2.70 x 0.83 x 1.46)
Amplifier type	Built-in DC amplifier	Built-in DC amplifier	Self-contained	Self-contained
Features	<ul style="list-style-type: none"> • Rugged metal body • 6 times normal sensing distance • NEMA 4X, 6P, IP67 • Vertical and horizontal body styles • Fuzzy logic mutual interference protection • CE conformance 	<ul style="list-style-type: none"> • Clear material detection specially tuned for glass and plastic bottles • Compensates for "lens effects" • IP67 rating, versatile NPN/PNP, L.O., D.O., in one unit • Rugged die cast metal housing 	<ul style="list-style-type: none"> • RGB color sensor detects subtle color differences • Remote TEACH function • Four-color storage capability • Lensed and fiber-optic versions 	<ul style="list-style-type: none"> • Color mark sensor • Remote control setup • Green LED detects yellow on white • Stable operation on shiny surfaces
Through-beam sensing distance	30 m (98.43 ft)	–	Varies depending on the model and fiber chosen	–
Retroreflective sensing distance	Polarized: 3 m (9.84 ft)	250 mm (9.84 in) or 1 m (3.28 ft)	–	–
Diffuse reflective sensing distance	700 mm (27.56 in) and 2 m (6.56 ft)	–	Varies depending on the model and fiber chosen	10 mm ±3 mm
Color sensing	–	–	Yes	Yes
Supply voltage	10 to 30 VDC	10 to 30 VDC	24 to 240 VDC	10 to 30 VDC, 10% Ripple max.
AC control output	–	–	–	–
DC control output type	NPN or PNP selectable	NPN/PNP switch selectable	NPN, PNP	NPN/PNP
Max. load	100 mA max. at 30 VDC	100 mA at 30 VDC	100 mA	100 mA
Alarm	–	–	–	–
Response time	1 ms ON/OFF (2 ms ON/OFF for short range diffuse models)	2 ms ON/OFF	1 output: standard - 3 ms high-speed - 1 ms 4 output: standard - 6 ms high-speed - 2 ms	50 µs
Materials:				
Lens	Acrylic	Acrylic	–	Acrylic
Case	Zinc die cast	Zinc die cast	Zinc-diecast	PBT
Bracket	Stainless steel	Stainless steel	Fiber Head: -X/MX: ABS	–
Cover	Op. panel: Sulfonated Polyether	Panel: Sulfonated polyether	PES	–
Enclosure rating	NEMA 1,4X, 6P, 12, 13, IP67	NEMA 6P, IP67	IP66 w/ protective cover in place	IP67
Light source	Pulse mod. infrared (880 nm) Red LED (700 nm) on retro	Red LED (670 nm)	Red, green, and blue LED	Green LED
Circuit protection	Load short circuit and reverse polarity	Reverse polarity and load short circuit	Reverse polarity, short-circuit	Short circuit, reverse polarity
Mutual interference protection	On all except through-beam models	Provided	–	–
Operation mode	Light-ON / Dark-ON switch selectable	Light-ON / Dark-ON switch selectable	Light-ON / Dark-ON switch selectable	Light-ON / Dark-ON, switch selectable
Applications	Washdown environments; Long range sensing 30 m; NPN /PNP selectable; CE conformance requirements; Highly shock resistant 100 g; Metal body	Clear material sensor; Rugged; Detects clear bottles reliably even with "lens effects"; Connector versions available	Color differentiation, Food and Bev, material handling, packaging applications	High-speed mark detection

PHOTOELECTRIC SENSORS				
				
	E3S-LS3N	E3C-V	E3HF	F3C-AA41
Dimensions mm (in)	19.0 H x 10.0 W x 34.0 D (0.79 x 0.39 x 1.33)	E3C-VS1G/ E3C-VS3R: 15 H x 10 W x 28 D (0.59 x 0.39 x 1.10) E3C-VM35R/ E3C-VS7R: 20 H x 10 W x 47 D (0.78 x 0.39 x 1.85)	28 H x 50 W x 7 D (1.10 x 1.97 x 0.28)	90 H x 18 W x 45 D (3.54 x 0.70 x 1.77)
Amplifier type	Printed circuit board sensor	Pinpoint/mark sensing head (Use separate amplifier)	Built-in DC amplifier	Roller conveyor sensor
Features	<ul style="list-style-type: none"> Stable detection without being affected by holes or notches Will detect any color PC board 	<ul style="list-style-type: none"> Accurately detects color marks against many different backgrounds Pinpoint beam enables it to detect small objects, marks and wires as small as 0.2 mm 	<ul style="list-style-type: none"> Thin profile 7 mm thick flat pack style sensor Can detect 0.5 mm (0.02 in) objects with included slits Light-ON or Dark-ON versions Top and side through holes for easy mounting 	<ul style="list-style-type: none"> Detects objects from underneath roller conveyor M12 connector Unique optical system for setting distance, eliminates background influences
Through-beam sensing distance	–	–	1 m (3.28 ft)	–
Retroreflective sensing distance	–	–	–	–
Diffuse reflective sensing distance	10 – 60 mm	E3C-VS1G: 10 ±2 mm E3C-VS3R: 30 ±5 mm E3C-VM35R: 35 ±5 mm (mark) 20 to 80 mm (spot) E3C-VS7R: 70 ±10 mm (mark) 40 to 110 mm (spot)	50 mm (1.97 in)	0 to 750 mm
Color sensing	Yes	Yes	–	–
Supply voltage	12 to 24 VDC ±10% Ripple max.	See E3C amplifiers	12 to 24 VDC	10 to 30 VDC
AC control output	–	See E3C amplifiers	–	–
DC control output type	NPN	See E3C amplifiers	NPN with pull-up resistor	NPN or PNP
Max. load	50 mA	See E3C amplifiers	NPN 80 mA relay sink logic NPN 3 mA voltage source logic	150 mA
Alarm	–	See E3C amplifiers	–	–
Response time	1 ms	See E3C amplifiers	6 ms ON/OFF or 10 ms ON/OFF on some models	10 ms max.
Materials:				
Lens	Acrylic	E3C-VS1G/VS3R: Plastic, polycarb.; E3C-VM35R/VS7R: Glass	Plastic	Acrylic
Case	ABS	Plastic	Plastic	ABS
Bracket	–	–	–	–
Cover	–	–	–	–
Enclosure rating	IP40	E3C-VS1G/VS3R: IP64 E3C-VM35R/VS7R: IP50	NEMA 1, 3, 4X, 12 IP64	IP40
Light source	Red LED	E3C-VS1G: Pulse modulated Green LED E3C-VS3R/VM35R/VS7R: Pulse modulated Red LED	Pulse modulated infrared LED	Infrared LED
Circuit protection	–	See E3C amplifiers	Reverse polarity and load short circuit	Load short circuit and reverse polarity
Mutual interference protection	–	See E3C amplifiers	–	Yes
Operation mode	Light-ON	See E3C amplifiers	Light-ON / Dark-ON separate versions	Light-ON / Dark-ON selectable
Applications	PC board detection	Color mark applications, inspection and accurate positioning	Thin profile 7 mm photoelectric sensor; Ideal for space constrained applications; Good for small object detection	Packaging, roller conveyor object detection, material handling

PHOTOELECTRIC SENSORS			
			
	F3C-AL	E3C-LDA	E3C-□□□□ Sensor Heads and Amplifiers
Dimensions mm (in)	90 H x 18 W x 45 D (3.54 x 0.70 x 1.77)	Amplifier: 32 H x 10 W x 82.7 D (1.25 x 0.393 x 3.25) Sensing Head: 25 H x 12.8 W x 33 D (0.98 x 0.50 x 1.29)	Sensor Heads: -S10: 14 H x 5.8 W x 10 D (0.55 x 0.22 x 0.39) -S20W: 12.5 H x 2.8 W x 20 D (0.49 x 0.11 x 0.78) -S30T: 15 H x 3 W x 7.85 D (0.59 x 0.11 x 0.31) -S30W: 8.4 H x 3 W x 15 D (0.33 x 0.11 x 0.59) -S50: 13 H x 7 W x 11 D (0.51 x 0.28 x 0.43) -1: 12 H x 8 W x 25 D (0.47 x 0.31 x 0.98) -2: 16 H x 12.4 W x 36 D (0.63 x 0.49 x 1.42) -DS5W: 19.5 H x 2.8 W x 18 D (0.77 x 0.11 x 0.71) -DS10: 15 H x 10 W x 28 D (0.59 x 0.39 x 1.10) Amplifiers: -A/C: 82.5 H x 49 W x 48 D (3.24 x 1.93 x 1.89) -JB4P/JC4P: 32.5 H x 14 W x 60 D (1.28 x 0.55 x 2.36) -GE4/GF4: 35.5 H x 20.7 W x 27.2 D (1.39 x 0.81 x 1.07) -WH4F: 75 H x 22.5 W x 80 D (2.95 x 0.88 x 3.15)
Amplifier type	Distance setting laser photoelectric sensor	Separate amplifier	Separate amplifier
Features	<ul style="list-style-type: none"> Laser diode M12 connector Spot diameter 1.5 x 4 mm at 700 mm 	<ul style="list-style-type: none"> Laser heads Three beam types: spot, line and area Beam focusable and adjustable optical alignment Same programming as E3X-DA 	Sensor Heads: <ul style="list-style-type: none"> Miniature interchangeable sensing heads Remote sensitivity adjustment Amplifiers: <ul style="list-style-type: none"> Multiple sizes Track mountable models, slim 1/16 DIN size socket mount amplifier
Through-beam sensing distance	–	–	-S10: 100 mm (3.94 in); -S20W: 200 mm (7.87 in); -S30W: 300 mm (11.81 in); -S30T: 300 mm (11.81 in); -S50: 500 mm (19.7 in); -1: 1 m (3.28 ft); -2: 2 m (6.56 ft)
Retroreflective sensing distance	–	2 to 7 m	–
Diffuse reflective sensing distance	120 to 700 mm	30 to 1000 mm	-DS5W: 50 mm (1.97 in); -DS10: 100 mm (3.94 in)
Color sensing	–	–	–
Supply voltage	10 to 30 VDC	12 to 24 VDC	12 to 24 VDC; -A/C: 100 to 240 VAC
AC control output	–	–	-A/C: SPDT relay
DC control output type	NPN or PNP	NPN or PNP	-JB4P/GF4: PNP; -JC4P/GE4: NPN; -WH4F: NPN and PNP
Max. load	150 mA	50 mA max.	-JB4P/JC4P/GF4: 100 mA at 24 VDC -WH4F: 100 mA at 40 VDC; -GE4: 80 mA at 24 VDC
Alarm	–	–	-JB4P/JC4P: 50 mA at 24 VDC
Response time	10 ms max.	Standard mode: 1 ms High-speed mode: 100 μs High-resolution mode: 4 ms	-JB4P/JC4P: 2 ms or 41 ms max ON/OFF (Switch selectable) -GE4/GF4/WH4F: 2 ms or 4 ms max ON/OFF (Switch selectable)
Materials:	Lens Acrylic Case ABS Bracket – Cover –	– PBT – Polycarbonate	Sensor Heads: Lens: Plastic, polycarbonate; Case: Plastic, polycarbonate; -2: Zinc die cast; Cable Sheath: Plastic, polyethylene – Amplifiers: Plastic case
Enclosure rating	IP40	IP50	Sensor Heads: -S10/S50/DS10: NEMA 1, 2, 12, IP64 -S20W/DS5W: NEMA 1, IP50; -S30: NEMA 1, IP60 -1/2: NEMA 1, 2, 4, 4X, 12, IP66 Amplifiers: NEMA 1, IP20; -JB4P: NEMA 1, 2, IP50
Light source	Laser, Class 2, Red 670 nm	Laser, Class 2, Red diode 650 nm	Pulse modulated IR LED
Circuit protection	Load short circuit and reverse polarity	Short circuit and reverse polarity	Short circuit, and reverse polarity -A/C: Not available
Mutual interference protection	Yes	Yes	–
Operation mode	Light-ON / Dark-ON selectable	Light-ON / Dark-ON selectable	Light-ON / Dark-ON; switch or jumper selectable
Applications	General purpose, minute object detection, material handling, packaging	All purpose, high-speed, mark sensing, transparency detection, color discrimination, minute object, high-precision positioning	Space constraint applications NOTE: Consult Omron for other models

Amplified Photomicrosensors

Omron Smart Solutions

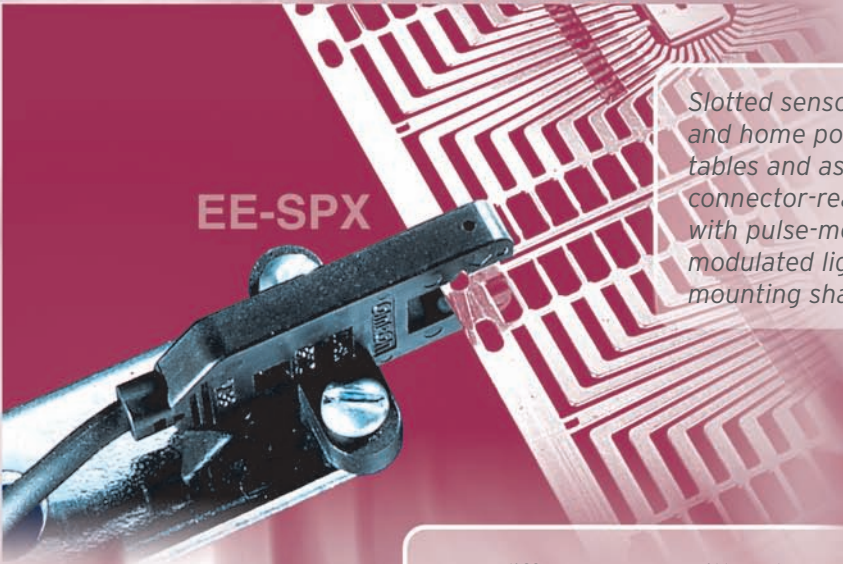

EE-SPX

Slotted sensors provide end-of-travel and home position signals for positioning tables and assembly robots. Choose connector-ready or pre-wired models with pulse-modulated or non-pulse-modulated light source in a wide range of mounting shapes.

Use diffuse sensors with pulse modulated light source to detect passing target objects; connector ready for easy installation.

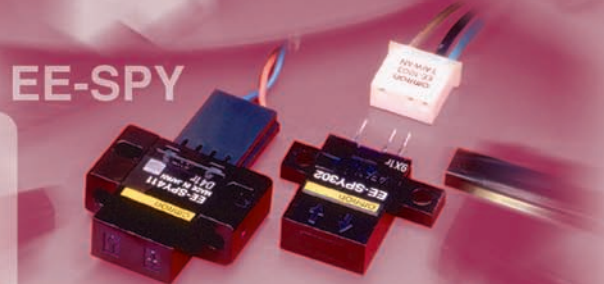

EE-SPY

Liquid level sensor easily mounts to clear clear sight glass; equipped with sensitivity selector to allow for pipe discoloration over time.



EE-SPX613

PHOTOMICROSENSORS

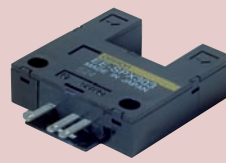

Amplified

Amplified

Amplified

Amplified

Sub-category	Slotted, non-pulse modulated, connector ready	Slotted, non-pulse modulated, pre-wired	Slotted, pulse modulated, connector ready	Slotted, pulse modulated, pre-wired
Model numbers	EE-SX470, EE-SX471, EE-SX472, EE-SX473, EE-SX474, EE-SX670, EE-SX671, EE-SX672, EE-SX673, EE-SX674, EE-SX670A, EE-SX671A, EE-SX672A, EE-SX673A, EE-SX674A, EE-SX470P, EE-SX471P, EE-SX472P, EE-SX473P, EE-SX474P, EE-SX670P, EE-SX671P, EE-SX672P, EE-SX673P, EE-SX674P	EE-SX770, EE-SX771, EE-SX772, EE-SX870, EE-SX871, EE-SX872, EE-SX770A, EE-SX771A, EE-SX772A, EE-SX870A, EE-SX871A, EE-SX872A, EE-SX770P, EE-SX771P, EE-SX772P, EE-SX870P, EE-SX871P, EE-SX872P, EE-SX770R, EE-SX771R, EE-SX772R, EE-SX870R, EE-SX871R, EE-SX872R	EE-SPX301, EE-SPX303, EE-SPX401, EE-SPX403, EE-SPX303-1, EE-SPX740, EE-SPX840, EE-SPX741, EE-SPX841, EE-SPX742, EE-SPX842, EE-SPX743, EE-SPX843	EE-SPX302-W2A, EE-SPX304-W2A, EE-SPX305-W2A, EE-SPX306-W2A, EE-SPX402-W2A, EE-SPX404-W2A, EE-SPX405-W2A, EE-SPX406-W2A
Connection type	Connector or soldering terminals Available connectors:** Solder connector EE-1001, Connector with 2 m cable EE-1006/EE-1006A bracket	Pre-wired cable	Connector or soldering terminals Available connectors:** Solder connector EE-1001, Connector with 2 m cable EE-1006/EE-1006A bracket Connector with 1 m cable for 740/840 series EE-1013	Pre-wired cable
Features	<ul style="list-style-type: none"> Standard, L-shaped, T-shaped and close mounting models Built-in indicator 	<ul style="list-style-type: none"> Standard, L-shaped, and T-shaped models UL, EMC and CE approvals Compact size Built-in indicator and optical axis guide 	<ul style="list-style-type: none"> Easily connects to TTLs, relays and PLCs Range of slot widths Built-in indicator Light modulation reduces external light interference Output of SPX301 / SPX401 / SPX303 / SPX403 can be converted to PNP 	<ul style="list-style-type: none"> Compact sensing heads Built-in indicator Light modulation reduces external light interference
Slot width/sensing distance mm (in)	5 (0.20)	5 (0.20)	3.6 (0.14) 5 (0.20) 13 (0.51)	3.6 (0.14) 5 (0.20)
Output logic	Light-ON/Dark-ON*	Light-ON or Dark-ON models	Light-ON or Dark-ON models	Light-ON or Dark-ON models
Supply voltage	5 to 24 VDC	5 to 24 VDC	5 to 24 VDC	5 to 24 VDC
Output type	NPN or PNP models	NPN or PNP models	NPN	NPN
Max. load current output	100 mA (NPN); 50 mA (PNP)	100 mA (NPN); 50 mA (PNP)	80 mA; 50 mA (SPX74/SPX84)	80 mA
Response frequency	1 kHz (3 kHz typical)	1 kHz	500 Hz	500 Hz
Enclosure ratings	IP50	IP60	IP50	IP50 except terminals
Ambient operating temperature	-25° to 55°C	-25° to 55°C	-10° to 55°C	-10° to 55°C
Ambient operating humidity	5% to 85% RH	5% to 85% RH	35% to 85% RH; 5% to 85% RH (SPX74/SPX84)	35% to 85% RH

*The EE-SX67□ Series can be used as Light-ON when the L terminal and positive (+) are connected. For Dark-ON, do not connect the L terminal.

PHOTOMICROSENSORS



Amplified

Amplified

Amplified

Amplified

Sub-category	Diffuse, non-pulse modulated, connector ready	Diffuse, pulse modulated, connector ready	Convergent reflective, pulse modulated, connector ready	Diffuse retro-reflective, pulse modulated, connector ready
Model numbers	EE-SY671, EE-SY672, EE-SB5M, EE-SB5MC, EE-SB5V, EE-SB5VC, EE-SB5V-E	EE-SPY301, EE-SPY302, EE-SPY401, EE-SPY402	EE-SPY311, EE-SPY312, EE-SPY411, EE-SPY412	EE-SPZ301-A, EE-SPZ401-A
Connection type	Connector or soldering terminals Solder connector: EE-1001 Connector with 2 m cable: EE-1006/EE-1006A bracket	Connector or soldering terminals Solder connector: EE-1002 Connector with 1 m cable: EE-1003	Connector or soldering terminals Solder connector: EE-1001 Connector with 2 m cable: EE-1006/EE-1006A bracket PNP output conversion connector EE-2002	Connector or soldering terminals Solder connector: EE-1002 Connector with 1 m cable: EE-1003
Features	<ul style="list-style-type: none"> Built-in sensitivity adjuster Selectable Light-ON or Dark-ON operation Output can be converted to PNP 	<ul style="list-style-type: none"> Easy connection to TTLs, relays and PLCs Light-ON indicator simplifies adjustment and optical axis monitoring Output can be converted to PNP 	<ul style="list-style-type: none"> Detects objects placed at least 20 mm in front of shiny backgrounds Detects objects as thin as 0.05 mm-dia. copper wire Detects dark-color objects Output can be converted to PNP 	<ul style="list-style-type: none"> Long sensing distance Easy sensitivity adjustment and optical axis monitoring with built-in indicator Use with optional reflector or highly reflective target
Slot width/sensing distance mm (in)	1 to 5 (0.04 to 0.20) 5 (0.20) 19 (0.75)	5 (0.20)	2 to 6 (0.08 to 0.24) 5 (0.20)	200 (7.87) with E39-R1 reflector
Output logic	Light-ON or Dark-ON*	Light-ON or Dark-ON	Light-ON or Dark-ON models	Light-ON or Dark-ON models
Supply voltage	5 to 24 VDC (EE-SY) 5 to 12 VDC (EE-SB)	5 to 24 VDC	5 to 24 VDC	5 to 24 VDC
Output type	NPN	NPN	NPN	NPN
Max. load current output	100 mA (EE-SY) 80 mA (EE-SB)	80 mA	80 mA	80 mA
Response frequency	50 Hz	100 Hz	100 Hz	100 Hz
Enclosure ratings	IP50	IP50	IP50 except terminals	IP50 except terminals
Ambient operating temperature	-10° to 55°C (EE-SY) -25° to 55°C (EE-SB)	-10° to 55°C	-10° to 55°C	-10° to 55°C
Ambient operating humidity	45% to 85% RH	35% to 85% RH	35% to 85% RH	35% to 85% RH

*EE-SY671 and EE-SY672 models can be used as Light-ON when the L terminal and positive (+) is connected. For Dark-ON, do not connect the L terminal.

PHOTOMICROSENSORS

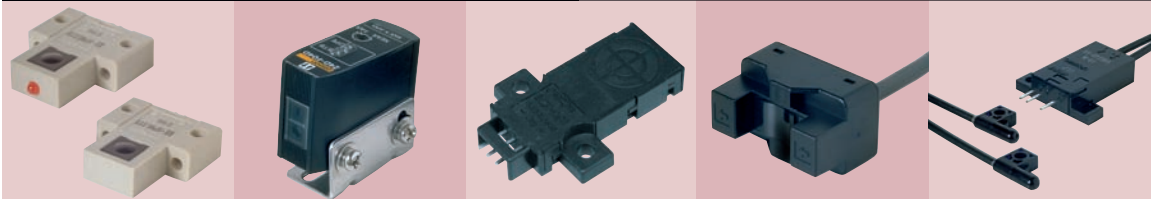

Amplified Amplified Amplified Amplified Amplified

Sub-category	Through-beam, pulse modulated	Reflective displacement sensor, non-pulse modulated	Inductive unshielded proximity sensor, connector ready	Liquid level sensor, pulse modulated, pre-wired	Fiber-optic, pulse modulated, connector ready
Model numbers	EE-SPW311, EE-SPW321, EE-SPW321-A, EE-SPW411, EE-SPW421, EE-SPW421-A	Z4D-F04A, Z4D-F04D	E2R-A01	EE-SPX613	*EE-SPZ301, *EE-SPZ401, EE-SPZ301Y-01, EE-SPZ401Y-01, EE-SPZ301W-02, EE-SPZ401W-02, EE-SPZ301W-01, EE-SPZ401W-01
Connection type	Connector with 2 m cable for EE-SPW311/411 Emitter: EE-1006L Receiver: EE-1006D EE-SPW321/421 Pre-wired with 2 m cable	Connector with 1 m cable: EE-1010D	Connector with 1 m cable: E22-01	Pre-wired, 1 m cable	Solder terminal or connector: Solder terminal EE-1002 Connector with 1 m wire EE-1003
Features	<ul style="list-style-type: none"> Provides long sensing distance in compact size EE-SPW321/421 feature a cable amplifier with 0.5 or 1 m cable between amp and sensing heads 	<ul style="list-style-type: none"> Compact, micro-displacement sensor provides resolution to 5 mm Analog or digital output models Ideal for double-sheet detection, material remaining on a web or roll 	<ul style="list-style-type: none"> Non-contact unshielded inductive proximity sensor detects metal targets regardless of color or surface texture Low profile space-saving shape 	<ul style="list-style-type: none"> Detects clear liquid presence by refraction Easy to install: straps to clear or translucent tubing Set sensitivity to match older pipe tinted by contents 	<ul style="list-style-type: none"> Sensing heads fit space-confined installations Visible indicator simplifies optical axis adjustment and monitoring
Slot width/sensing distance mm (in)	EE-SPW311/411 1 m (3.28 ft) EE-SPW321/421 30 cm (11.81 in)	4±1.25 (0.16±0.05)	5 (0.20)	6 to 13 (0.24 to 0.52) OD tubing with minimum 1 (0.04) thick walls	EE-SPZ301/401: 20 (0.79) with E32-TC200 cable 1 to 6 (0.04 to 0.24) with E32-DC200 cable EE-SPZ□01W-01: 30 (1.18) EE-SPZ□01W-02: 5 (0.20) EE-SPZ□01Y-01: 1 to 3 (0.04 to 0.12)
Output logic	Light-ON or Dark-ON models	Light-ON	Normally open	Light-ON or Dark-ON, selectable	Light-ON or Dark-ON models
Supply voltage	5 to 24 VDC 12 to 24 VDC	12 to 24 VDC	5 to 24 VDC	12 to 24 VDC	5 to 24 VDC
Output type	NPN	1 to 5 V analog or NPN discrete	NPN	NPN	NPN
Max. load current output	100 mA	50 mA (NPN)	100 mA	100 mA	80 mA
Response frequency	1 ms max.	5 ms max. analog 1.5 ms max. NPN	5 kHz	–	100 Hz
Enclosure ratings	IP60 (311/411) IP64 (321/421)	IP50	IP50	IP50	IP50
Ambient operating temperature	-10° to 55°C (311/411) -20° to 55°C (321/421)	-10° to 55°C	-10° to 55°C	-10° to 55°C	-10° to 55°C
Ambient operating humidity	45% to 85% RH (311/411) 35% to 85%RH (321/421)	35% to 85% RH	35% to 85% RH	5% to 85% RH	35% to 85% RH
		E39-L69 mounting bracket is optional.		Includes cable ties and rubber anti-slip bands.	*Order E32-Series fiber-optic cables separately.

AMPLIFIED PHOTOMICROSENSORS

Proximity Sensors

Omron Smart Solutions

E2A

Cost-effective extended range proximity sensor features one-piece, threaded barrel construction with wrench flats. Choose connector or pre-wired versions; wide range of sizes and lengths.



E2E

Inductive proximity sensors feature rugged thick barrel. Choose from standard sizes; DC 2-wire, DC-3-wire and AC 2-wire models; shielded and unshielded versions, pre-wired and connector-ready.



America's best-selling capacitive sensor detects objects regardless of material or color. Can be tuned to ignore a container wall.

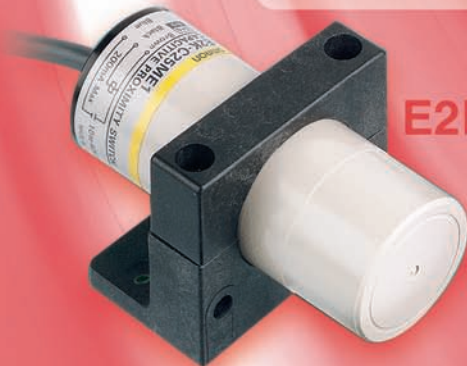



E2K-C

Weld field immune inductive proximity sensors that can withstand current at only 1 inch away from the 20,000-amp welding electrode. Available in cylindrical and square form factors.

E2AW



INDUCTIVE PROXIMITY SENSORS			
THREADED CYLINDRICAL			
			
	E2E	E2E2	E2A
Product type	Short Barrel Cylindrical	Long Barrel Cylindrical	Extended Range OEM Proximity Sensor
Dimensions mm (in)	Dia. 4 x 25 (0.16 x 0.98); M5 x 25 (0.20 x 0.98); Dia. 5.4 x 25 (0.21 x 0.98); M8 x 26 (0.31 x 1.02); M12 x 33 (0.47 x 1.30); M18 x 38 (0.71 x 1.50); M30 x 43 (1.18 x 1.69)	M12 x 55 (0.47 x 2.17); M18 x 60 (0.71 x 2.36); M30 x 65 (1.18 x 2.56)	M8 Long and short barrel M12 Long and short barrel M18 Long and short barrel M30 Long and short barrel
Features	<ul style="list-style-type: none"> • Omron's flagship highest quality proximity sensor family • Vacuum potted internal circuitry • Multiple connector versions • Wrench flats for easy installation • Superior barrel thickness and highest tightening torques available • Pre-wired 2 m or 5 m cables • Multiple pigtail versions • Highly visible LED 	<ul style="list-style-type: none"> • Vacuum potted internal circuitry • Multiple connector versions • Same solid construction and high quality as E2E with long barrel bodies • Fully threaded body • Pre-wired 2 m or 5 m cables • Multiple pigtail versions • Highly visible LED indication 	<ul style="list-style-type: none"> • Extended sensing distances • Economical large quantity OEM pricing • Vacuum potted internal circuitry • One-piece housing • Stainless steel M8 barrel versions • Wrench flats for easy installation • Superior barrel thickness and highest tightening torques available • Easily customized • Pre-wired or connector versions
Shielded sensing distances	0.8, 1, 1.5, 2, 3, 5, 7, and 10 mm	2, 3, 5, 7, and 10 mm	2, 4, 8, and 15 mm
Unshielded sensing distances	2, 4, 5, 8, 10, 14, 18, and 20 mm	5, 8, 10, 14, 18, and 20 mm	4, 8, 16, 20, and 30 mm
DC supply voltage	12 to 24 VDC (10-30 VDC operating)	12 to 24 VDC (10-55 VDC operating)	12 to 24 VDC (10-32 VDC operating)
AC supply voltage	24 to 240 VAC or 90 to 140 VAC 50/60 Hz	24 to 240 VAC 50/60 Hz	N/A
2-wire DC output	NO, NC; 100 mA max.	NO, NC; 100 mA max.	N/A
3-wire DC output	NPN-NO, NPN-NC, PNP-NO, PNP-NC; 100 or 200 mA max.	NPN-NO, NPN-NC Open Collector PNP-NO, PNP-NC Open Collector 200 mA max.	NPN-NO, NPN-NC Open Collector PNP-NO, PNP-NC Open Collector 200 mA max.
AC 2-wire output	NO, NC; 300 mA max.	NO, NC; 200 or 300 mA max.	N/A
Response frequency	25 Hz to 3 kHz	25 Hz to 1.5 kHz	100 Hz to 1.5 kHz
Connections	PVC Cables / Robotic Cables; Multiple M12 Micro Change® or M8 Nano Change® connectors; Multiple pigtail connectors	PVC Cable 2 m or 5 m; M12 Micro Change® connector	PVC Cable 2 m or 5 m; M12 Micro Change® connectors 4 Pin; M8 Nano Change® connectors 3 Pin; M8 only stainless steel or NPB barrel
Enclosure	Nickel plated brass barrel; Stainless steel barrel on M8 and smaller models; Sensing face is PBT; IEC IP67 / 1200 PSI Washdown; NEMA 1, 3, 4, 6, 12, 13	Nickel plated brass barrel; Sensing face is PBT; IEC: IP67/ 1200 PSI Washdown; NEMA: 1, 4, 6, 12, 13	Nickel plated brass barrel; Sensing face is PBT; IEC IP67
Agency approvals	UL, CSA, CE	UL, CSA, CE	UL, CSA, CE
Circuit protection	Output short circuit, surge absorber, reverse polarity specific model dependent	Output short circuit, surge absorber, reverse polarity specific model dependent	Output short circuit, surge absorber, power source reverse polarity, and output reverse polarity
Other	Self diagnostic versions; AC/DC versions; Alternate frequency versions; Custom cable lengths and connectors	Alternate frequency versions; Custom cable lengths and connectors	Yellow LED 4 x 90° on connector types; Highly visible yellow LED on pre-wired types; World standard PROX
Application	Use when high quality, high reliability is needed; Standard distance inductive prox for ferrous metal sensing; 1200-PSI Washdown rated; Connector or pigtail versions; Easily customized; DC2W, DC3W, AC2W, AC/DC	Use when high quality, high reliability is needed in a long barrel body; Standard distance inductive prox for ferrous metal sensing; 1200-PSI Washdown Rated; DC2W, DC3W, AC2W	Use when extended range general purpose sensing is required; Extended distance inductive prox for ferrous metal sensing; Large quantity OEM pricing available Easily customized; DC3W

INDUCTIVE PROXIMITY SENSORS
THREADED CYLINDRICAL WELD FIELD IMMUNE







E2F

E2AW

E2QW

Product type	Threaded Plastic Cylindrical	Weld Field Immune Inductive	Weld Field Immune 9-Way Configurable Inductive
Dimensions mm (in)	M8 x 40 (0.31 x 1.57) M8 x 30 (0.31 x 1.18) M12 x 40 (0.47 x 1.57) M12 x 35 (0.47 x 1.38) M18 x 40 (0.71 x 1.57) M30 x 50 (1.18 x 1.97)	M12 x 76 M18 x 76 M30 x 76 M30 x 67	40 mm wide x 68.5 mm high
Features	<ul style="list-style-type: none"> • IP68 watertight construction withstands washdown • Plastic cylindrical inductive • AC 2-wire or DC 3-wire-NPN models • DC models have short-circuit protection and reverse polarity protection 	<ul style="list-style-type: none"> • Weld field and noise immune • WFI circuitry is designed to operate within 1 inch of a resistance welding electrode at 20,000 Amperes RMS • NEMA 1, 3, 4, 6, 13 • AC/DC2W or DC3W-PNP type • M12, M18 M30 Barrel Sizes 	<ul style="list-style-type: none"> • Weld field and noise immune • IP67 • AC/DC2W or DC3W-PNP type • Extended Range WFI Proximity • Rotatable head configurable in 9 different sensing directions • 15 mm to 35 mm sensing ranges
Shielded sensing distances	1.5, 2, 5, 10 mm	M12-2 mm, M18-5 mm, M30-10 mm	15 mm, 20 mm, 25 mm
Unshielded sensing distances	N/A	M12-4 mm, M18-8 mm, M30-15 mm	25 mm, 35 mm
DC supply voltage	12 to 24 VDC (10-30 VDC operating)	10 to 30 VDC	10 to 30 VDC
AC supply voltage	24 to 240 VAC (20 to 264 VAC operating)	20 to 230 VAC/DC	20 to 150 VAC/DC
2-wire DC output	N/A	–	–
3-wire DC output	NPN-NO, NPN-NC, PNP-NO, PNP-NC; 200 mA max.	PNP-NO, 200 mA max.	PNP-NO, 200 mA max.
AC 2-wire output	NO, NC; 100, 300 or 500 mA max.	N.O. 500 mA max.	N.O. 200 mA max.
Response frequency	25 Hz to 2 kHz	16 Hz	AC/DC-10 Hz, DC3W-150 Hz
Connections	PVC Cable 2 m standard, 5 or 10 m optional	4 Pin Euro for DC3W models 4 Pin Micro for DC3W models 3 Pin Micro for AC/DC models	4 Pin Euro for DC3W models 3 Pin Micro for AC/DC models
Enclosure	Polyallylate; IEC IP68; NEMA: 1, 3, 4, 6, 12, 13	Weld flash proof, hard coated metal housing; High temperature abrasion-resistant sensing face; NEMA: 1, 3, 4, 6, 13	Weld flash proof, hard coated metal housing; High temperature abrasion-resistant sensing face; NEMA: 1, 3, 4, 6, 13
Agency approvals	UL (on US models), CSA	UL, CSA	UL, CSA
Circuit protection	DC Models: Output short circuit, surge absorber, reverse polarity; AC Models: Add –53 for short circuit protection and add –US for UL listed version	DC models have non-latching short-circuit protection and reverse polarity protection; AC/DC2W models are latching SCP type with reverse polarity protection	DC models have non-latching short-circuit protection and reverse polarity protection; AC/DC2W models are latching SCP type with reverse polarity protection
Other	Alternate frequency versions; 5 m or 10 m cable lengths; Optional short circuit protection models; Optional UL listed AC versions	Cordsets available 2M, 5M, 10M straight or 90's PVC with E-coated or SS coupling nuts; PUR Black with E-coated or SS coupling nuts; TPE coated cables with E-coated or SS coupling nuts	Cordsets available 2M, 5M, 10M straight or 90's PVC with E-coated or SS coupling nuts; PUR Black with E-coated or SS coupling nuts; TPE coated cables with E-coated or SS coupling nuts
Application	Use when IP68 rating is needed; Use where metal barrels will corrode; Standard distance inductive prox for ferrous metal sensing DC3W or AC2W	Standard sensing distance; Weld field immune inductive proximity sensors for automotive weld lines and extremely harsh environments	Extended sensing distance; Weld field immune inductive proximity sensors for automotive weld lines and extremely harsh environments

	INDUCTIVE PROXIMITY SENSORS HARSH ENVIRONMENT		MINIATURE	
				
	E2EQ	E2KQ	E2EC	E2S
Product type	Teflon-Coated Cylindrical Inductive	Teflon Cylindrical Capacitive	Subminiature Prox with In-Line Amp	Subminiature Rectangular Inductive Prox
Dimensions mm (in)	M12 x 38 (0.47 x 1.50) M18 x 47 (0.71 x 1.85) M30 x 56 (1.18 x 2.20)	M18 x 61.8 (0.71 x 2.43)	Dia. 3 x 12 (0.12 x 0.47) Dia. 5.4 x 18 (0.21 x 0.71) Dia. 8 x 18 (0.31 x 0.71) M12 x 18 (0.47 x 0.71)	5.5 x 5.5 x 19 (0.22 x 0.22 x 0.75) 7.4 x 8 x 23 (0.29 x 0.31 x 0.91) 8 x 8 x 26 (0.31 x 0.31 x 1.02)
Features	<ul style="list-style-type: none"> Teflon-coated metal housing ensures high-tightening torque Prewired versions available Resistant to weld spatter DC 2-wire M12, M18, M30 barrel sizes Long sensing distance type available: 4 mm to 15 mm 	<ul style="list-style-type: none"> Oil-resistant cable Sensitivity adjustment allows sensing range from 6 to 10 mm Teflon mounting nuts and brass washers allow easy installation/maintenance 	<ul style="list-style-type: none"> Subminiature cylindrical inductive prox with in-line amplifier Robot cable for high-flex applications DC 2-wire version reduces wiring time Operation and stability indicator allows easy set-up and monitoring 	<ul style="list-style-type: none"> Extended sensing distances Economical large quantity OEM pricing Vacuum potted internal circuitry One-piece housing Stainless steel M8 barrel versions Wrench flats for easy installation Superior barrel thickness and highest tightening torques available Easily customized Pre-wired or connector versions
Shielded sensing distances	3, 7, 10 mm (standard)	–	0.5, 0.8, 1.5, 2.5, 3, 4 mm	2, 4, 8, and 15 mm
Unshielded sensing distances	–	6 to 10 mm	N/A	4, 8, 16, 20, and 30 mm
DC supply voltage	12 to 24 VDC	12 to 24 VDC	12 to 24 VDC	12 to 24 VDC (10-32 VDC operating)
AC supply voltage	–	–	N/A	N/A
2-wire DC output	NO; 100 mA max.	–	NO, NC; 100 mA max.	NO, NC; 50 mA max.
3-wire DC output	–	NPN-NO; 100 mA max.	NPN-NO, NPN-NC, PNP-NO, PNP-NC; 100 mA max. N/A	NPN-NO, NPN-NC, PNP-NO, PNP-NC; 50 mA max.
AC 2-wire output	–	–	N/A	N/A
Response frequency	0.4 kHz, 0.5 kHz, 1 kHz	–	1 kHz to 1.5 kHz	1 kHz
Connections	PVC cable, 2 m M12 Micro Change® connector	PVC cable, 2 m	Robotic Cable 2 m or optional 5 m; Optional pigtail versions	1 m cable standard
Ambient operating temperature	-13°F to 158°F	-13°F to 158°F	-13°F to 135°F	-13°F to 135°F
Enclosure	IEC: IP67	IEC: IP66	IEC: IP67 (IP64 for DC 3-wire); NEMA: 1, 3, 4, 6, 12, 13 (for DC 2-wire only)	IEC: IP67
Agency approvals	–	–	–	–
Circuit protection	Surge absorber and output short circuit	Reverse polarity connection and surge absorber	Surge absorber and output short circuit (DC 2-wire); Surge absorber (DC 3-wire)	Reverse polarity connection and surge absorber
Other	–	–	Alternate frequency versions	Alternate frequency versions; Front and end sensing models
Application	Automotive welding, machine tool	Oil and chemical resistant for use in metal cutting, chemical hardening and welding operations	Sub-miniature sensing head with in-line separate amplifier; Use when space is confined; Use in high-flex applications like robotic grippers; DC2W or DC3W	Smallest rectangular sensor available; Extremely economical; Use when space is confined DC2W or DC3W

CAPACITIVE PROXIMITY SENSORS

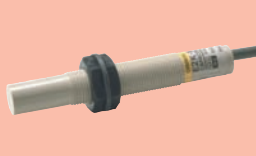

E2K-F

E2K-X

E2K-C

E2J

Product type	Flat-Pack Rectangular Capacitive	Threaded Cylindrical Capacitive	Adjustable Cylindrical Capacitive	Adjustable Flat Rectangular Capacitive
Dimensions mm (in)	50 x 20 x 10 (1.97 x 0.79 x 0.39)	M12 x 80 (0.47 x 3.15); M18 x 80 (0.71 x 3.15); M30 x 80 (1.18 x 3.15)	34 Dia. x 82 (1.34 x 3.23)	Amp: 59 x 12 x 29 (2.32 x 0.47 x 1.14) Sensors: 30 x 20 x 5.5 (1.18 x 0.79 x 0.22) 40 x 30 x 5.5 (1.57 x 1.18 x 0.22)
Features	<ul style="list-style-type: none"> • Flat, thin capacitive sensor fits space confined installations • Ideal for mounting directly to metal walls • Detects glass, plastic, wood, water, oil and metals • Fixed distance or adjustable models 	<ul style="list-style-type: none"> • Threaded-body sensors detect glass, wood, water oil, plastic and metal • Fixed sensitivity for simple installation • Operation indicator, all models • AC 2-wire and DC 3-wire models 	<ul style="list-style-type: none"> • Built-in amplifier allows adjustable detecting distances • Allows indirect detection of objects inside non-metallic containers • AC 2-wire and DC 3-wire models 	<ul style="list-style-type: none"> • Separate amplifier with adjustable sensitivity • Compact sensing heads • Highly flexible robotic-grade cable • DC 3-wire NPN open collector
Shielded sensing distances	–	–	–	–
Unshielded sensing distances	10 mm	4, 8, 15 mm	3 to 25 mm adjustable	10 mm, 20 mm
DC supply voltage	10 to 30 VDC	10 to 30 VDC	10 to 40 VDC	24 VDC
AC supply voltage	–	90 to 250 VAC	90 to 250 VAC	–
2-wire DC output	–	–	–	–
3-wire DC output	NPN-NO, NPN-NC; 100 mA max.	NPN-NO, NPN-NC, PNP-NO, PNP-NC; 200 mA max.	NPN-NO, NPN-NC, PNP-NO, PNP-NC; 200 mA max.	NPN-NO/NC; 100 mA max.
AC 2-wire output	–	NO, NC; 200 mA max.	NO, NC; 200 mA max.	–
Response frequency	100 Hz	10 Hz to 100 Hz	10 Hz to 70 Hz	70 Hz
Connections	3 m cable standard	2 m cable	2 m cable	Amp: 2 m cable; Sensor: 1 m cable
Ambient operating temperature	14°F to 131°F	-13°F to 158°F	-13°F to 158°F	14°F to 131°F
Enclosure	IEC: IP66 NEMA: 1, 4, 12, 13	IEC: IP66 NEMA: 1, 4, 12, 13	IEC: IP66 NEMA: 1, 4, 12, 13	IEC: IP66 (IP50 for amplifier)
Agency approvals	–	UL	UL	–
Circuit protection	Reverse polarity connection	AC2W: Surge absorber; DC3W: Reverse polarity connection and surge absorber	AC2W: Surge absorber; DC3W: Reverse polarity connection and surge absorber	Output short circuit, surge absorber, reverse polarity connection
Other	New adjustable sensing distance models available	–	Mounting bracket included	–
Application	Sensing non-metallic target, ideal for semiconductor and plastics, level control applications	General purpose type for plastics, level control	Tank sight glass for level control; non-metallic container fill inspection	Ideal for robot hands and various built-in applications for material handling and assembly verification such as CD-ROMs in jewel cases

Limit Switches

Omron Smart Solutions

D44-N



Heavy-duty, general-purpose limit switches feature plug-in construction for easy installation and long service life.



D4CC



Compact enclosed switch is triple sealed for reliable operation, and comes connector-ready for quick servicing or replacement without rewiring.



Enclosed limit switch with large breaking capacity with wide range of actuators, also available in sealed versions.



ZE/ZV/ZV2

LIMIT SWITCHES





D4A-N

WL

D4C

Dimensions mm (in)	104.5 H x 42.0 W x 44 D (4.11 x 1.65 x 1.73)	94.1 H x 40.0 W x 41.5 D (3.70 x 1.57 x 1.63)	55 H x 40 W x 16 D (2.17 x 1.58 x 0.63)
Features	<ul style="list-style-type: none"> • Heavy-duty, general-purpose limit switch • Convenient plug-in construction for easy installation and field maintenance • Waterproof and oil-tight 	<ul style="list-style-type: none"> • CE approved • General-purpose single pole/double break limit switch • Wide variety of standard, high-precision and overtravel types • Waterproof, oil-tight and dust-proof construction 	<ul style="list-style-type: none"> • CE approved • Compact, high-precision prewired enclosed limit switch • Slim-line body design ideal for limited access areas and gang mounting
Switching capacity	10 A continuous – 120, 240, 480, 600 VAC, NEMA A600 (SPDT without indicator); 10 A continuous - 120, 240 VAC NEMA A300 (SPDT with indicator); 5 A continuous – 120, 240, 480 600 VAC NEMA B600 (DPDT, without indicator)	10 A, 125 VAC inductive load; NEMA A600	5 A, 125 VAC, resistive load; NEMA B300
Contact configuration	SPDT or DPDT double break	SPDT double break	SPDT (form C)
Mechanical service life (operations)	50 million minimum (SPDT); 30 million minimum (DPDT)	15 million minimum	10 million minimum
Connection	1/2-14 NPT conduit entrance, terminal screws	1/2-14 NPT conduit entrance, terminal screws	Prewired with 3 meters (9.8 ft.) cable
Enclosure rating	UL 3, 4, 4X, 6P and 13; NEMA 1, 2, 3, 3R, 4X, 5, 6P, 12 and 13; IP67	UL 3, 4 and 13; NEMA 1, 2, 3, 3R, 4X, 5 6P, 12 and 13; IP67	UL 3, 4 and 13; NEMA 1, 3, 3R, 4, 5, 6, 12 and 13; IP67
Actuators	Side rotary, use separate levers; Plain side plunger; Vertical side roller plunger; Horizontal side roller plunger; Adjustable side plunger; Plain top plunger; Top roller plunger; Adjustable roller plunger; Spring wire wobble lever; Plastic rod wobble lever; Cat whisker wobble lever; Coil spring wobble lever	Short, medium and long roller levers; Flush mounting roller lever; Flange mounting roller lever; Adjustable roller lever; Adjustable rod lever; Fork roller levers; Plain top plunger; Top roller plunger; Top ball plunger; Plain side plunger; Side roller plunger; Side ball plunger; Steel wire wobble lever; Nylon rod wobble lever; Coil spring wobble levers	Pin plunger; Sealed plunger; Roller plunger; Sealed roller plunger; Crossroller plunger; Sealed cross roller plunger; Bevel plunger; Coil spring; Roller lever

LIMIT SWITCHES			
			
	D4CC	ZE/ZV/ZV2	ZC
Dimensions mm (in)	73.2 H x 40 W x 16 D (2.88 x 1.58 x 0.63)	102.1 H x 25.4 W x 86 D (4.02 x 1.00 x 3.39)	65.4 H x 21.5 W x 60 D (2.58 x 0.85 x 2.36)
Features	<ul style="list-style-type: none"> • Compact, connector-ready enclosed limit switch • Triple sealed construction • Quickly replace or service the switch without rewiring 	<ul style="list-style-type: none"> • Enclosed limit switch with a large breaking capacity • Choose among side-mounting (ZE), diagonal side mounting (ZV2) and base-mounting (ZV) housings 	<ul style="list-style-type: none"> • Ideal for gang mounting • Small high-precision limit switch that responds to small operating force • Models available with rubber seal boot to protect the actuator
Switching capacity	1 A, 125 VAC resistive load; 1 A, 30 VDC resistive load	15 A, 125 VAC, inductive load	10 A, 125 VAC, inductive load; NEMA A300
Contact configuration	SPDT (form C)	SPDT (form C)	SPDT (form C)
Mechanical service life (operations)	10 million minimum	10 million minimum	10 million minimum
Connection	Accepts Omron's Y96E or Brad Harrison MicroChange™ connector cordsets	1/2-14 NPT conduit entrance, terminal screws	Terminal screws or prewired with 1 m (3.28 ft) cable
Enclosure rating	UL 3, 4 and 13 (pending for DC types); NEMA 1, 3, 3R, 4, 5, 6, 12 and 13; IP67	NEMA 1, 2, 3, 4, 5, (-N type); 1 (-Q type); IP60 (-Q); IP65 (-N)	NEMA 1, 2, 3, 4, 5, 13; IP67
Actuators	Center rotary roller lever; Pin plunger; Roller plunger; Crossroller plunger; Bevel plunger; Low operating force roller lever; Sealed plunger; Sealed roller plunger; Sealed crossroller plunger; Panel mount pin plunger; Panel mount roller plunger; Panel mount crossroller plunger; Plastic rod lever	Top plunger; Roller plunger; Crossroller plunger; Roller arm lever; One-way action arm lever; Rod lever; Coil spring (ZE, ZV); Maintained contact plunger (ZE, ZV); Sealed versions of all actuators available	Pin plunger; Panel mount plunger; Panel mount roller plunger; Panel mount cross roller plunger; Sealed roller plunger; Sealed cross roller plunger; Short hinge lever; Hinge lever; Short hinge roller lever; Hinge roller lever; One-way action short hinge roller lever; One-way action hinge roller lever

Other Sensor Solutions

Omron Smart Solutions



Pressure

Compact sensors with or without digital displays help monitor gauge pressure, vacuum and differential pressure conditions.



Detect products regardless of color, texture or glossiness at long range. Also detects powder in storage tanks.

Ultrasonic



Encoders



Incremental and absolute encoders provide reliable positioning feedback for motors, lifts and other rotating equipment.

PRESSURE SENSORS

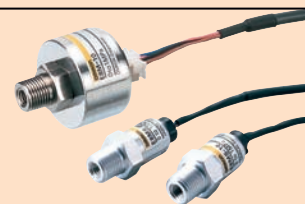

E8Y

E8F2

E8M/E8MS

Dimensions mm (in)	31 x 30 x 29.8 (1.22 x 1.18 x 1.17)	28 x 28 x 29 (1.10 x 1.10 x 1.14)	29.7 H x 15 dia. (max.) (1.17 x 59 dia. [max.]) 26 H x 19 W x 42.5 D (1.02 X 0.75 X 1.67) 31 H x 27.5 dia. (1.22 x 1.08)
Features	<ul style="list-style-type: none"> • Cube, miniature package • Easy-to-read LED display • Programmable teach modes • CE approved 	<ul style="list-style-type: none"> • Mini-cube • Miniature and light weight • Digital and analog display • CE approved 	<ul style="list-style-type: none"> • Miniature • Separate controller • Small and light weight • Programmable multi-channel outputs
Display units	psi or kPa	kPa, torr, psi	E8M = None, K3C = kPa, kgf/cm ² , mmHg, mmH ₂ O
<i>Pressure range available</i>			
Differential pressure	0 to 0.29 psi (0 to 2 kPa) 0 to 0.725 psi (0 to 5 kPa)	–	0 to 0.145 psi (0 to 1kPa) [E8M-A1]
Positive pressure	–	0 to 14.5 psi (0 to 100 kPa) 0 to 145 psi (0 to 1 MPa)	0 to 14.5 psi (0 to 100kPa) [E8MS-01] 0 to 145 psi (0 to 1MPa)
Negative pressure	–	0 to -14.6 psi (0 to -101 kPa)	0 to -14.5 psi (0 to -101kPa)
Applicable material	Non-corrosive, non-flammable gases or air	Non-corrosive, non-flammable gases or air	Non-corrosive, non-flammable gases or air
Pressure port	4.5 mm dia. resin pipe or NPT 1/8	NPT 1/8 or M5	PT 1/8 or M5
Supply voltage	12 to 24 VDC	12 to 24 VDC	12 VDC sensor, 24 VDC controller
<i>Output</i>			
Analog	4 to 20 mA	1 to 5 V	1 to 5 V
On / Off	100 mA, NPN open collector	30 mA, NPN open collector	30 mA, NPN open collector
Enclosure	IP40	IP50	IP50

PRESSURE SENSORS



E8CB

E8CC

E8EB

Dimensions mm (in)	15 x 26.8 x 52.5 (0.59 x 1.06 x 2.07)	15 x 29.5 x 67 (0.59 x 1.16 x 2.64)	17.5 x 30 x 44 (0.69 x 1.18 x 1.73)
Features	<ul style="list-style-type: none"> • Flat pack • Slim package, just 15 mm wide • Two-turn pressure adjustment 	<ul style="list-style-type: none"> • Display flat pack • Slim package – 15 mm wide • DIN rail mount compatible • LCD display 	<ul style="list-style-type: none"> • General purpose • Analog and digital outputs • NPN and PNP outputs available
Display units	None	kPa, kgf/cm ² , cmHg	None
<i>Pressure range available</i>			
Differential pressure	–	–	–
Positive pressure	0 to 14.2 psi (0 to 98 kPa)	0 to 14.2 psi (0 to 98 kPa) 0 to 142.1 psi (0 to 980 kPa)	0 to 14.2 psi (0 to 98 kPa) 0 to 142.1 psi (0 to 980 kPa)
Negative pressure	0 to -14.6 psi (0 to -101 kPa)	0 to -14.6 psi (0 to -101 kPa)	0 to -14.2 psi (0 to -98 kPa)
Applicable material	Non-corrosive, non-flammable gases or air	Non-corrosive, non-flammable gases or air	Non-corrosive, non-flammable gases or air
Pressure port	NPT 1/8 or M7	NPT 1/8 or M8	NPT 1/8
Supply voltage	12 to 24 VDC	12 to 24 VDC	24 VDC
<i>Output</i>			
Analog	1 to 5 V	1 to 5 V	1 to 5 V
On / Off	80 mA, NPN open collector	80 mA, NPN open collector	80 mA, NPN or PNP open collector
Enclosure	IP50	IP50	IP54

ENCODERS



E6A2

E6B2

E6C2-C

E6C3-CWZ□□H

Dimensions mm (in)	25 dia. x 29 L (0.98 x 1.14)	40 dia. x 39 L (1.57 x 1.54)	50 dia. x 60 L (1.97 x 2.36)	50 dia. x 38 L (1.97 x 1.50)
Shaft diameter mm (in)	4 (0.16)	6 (0.24)	6 (0.24)	8 (0.32)
Type	Incremental	Incremental	Incremental	Incremental
Features	<ul style="list-style-type: none"> • CE approved miniature sized encoder • Small operating torque • Ideal for small and high-density equipment • Zero index function for positioning applications available 	<ul style="list-style-type: none"> • CE approved • Ideal for most general-purpose applications • Extended signal transmission distances • Zero phase can be easily adjusted using origin indicating function • Line driver output available 	<ul style="list-style-type: none"> • Drip-proof construction • Shaft withstands heavy loads, 5 kgf radially, 3 kgf thrust (axially) • Short circuit protection • Space-saving, A-slant cable protrusion for ease of mounting 	<ul style="list-style-type: none"> • CE approved and available with complimentary outputs for interfacing to NPN or PNP inputs • Drip-proof construction • Surge protection • Ideal for tough environments
Resolution	10 to 360 pulses/revolution	10 to 2,000 pulses/revolution	10 to 2,000 pulses/revolution	100 to 3,600 pulses/revolution
Output phase(s)	Output A; Outputs A & B (100, 200 pulses/rev only); Outputs A, B & Z (100, 200 pulses/rev only)	Outputs A, B and Z (reversible)	Outputs A, B, and Z (reversible) Line driver AĀ, BĪ, and ZĪ	Outputs A, B and Z (reversible)
Output phase difference	90°±45°	90°±45°	90°±45°	90°±45°
Maximum response frequency	300 kHz (30,000 pulses/sec)	100 kHz (100,000 pulses/sec)	100 kHz (100,000 pulses/sec)	100 kHz (100,000 pulses/sec)
Maximum rpm	5,000 rpm	3,000 rpm	6,000 rpm	6,000 rpm
Supply voltage	5 to 12 VDC, 12 to 24 VDC	5 to 12 VDC; 5 to 24 VDC; 5 VDC	5 to 12 VDC; 5 to 24 VDC; 5 VDC; 12 to 24 VDC	5 to 24 VDC
Current consumption	50 mA max.	50 mA max.	160 mA max.	100 mA
Output form and capacity	2 kΩ output impedance (voltage output); 30 mA (NPN open collector output)	2 kΩ output impedance (voltage output); 35 mA (NPN open collector output); -20 to 20 mA (line driver)	35 mA max. (NPN or PNP open collector); 2 kΩ output impedance (voltage output); -20 to 20 mA (line driver)	35 mA max. (NPN or PNP open collector)
Shaft loading: radial	1 kgf (7.2 ft-lbs.)	3 kgf (21.7 ft-lbs.)	5 kgf (11.0 ft-lbs.)	80 N
Shaft loading: axial	0.5 kgf (3.6 ft-lbs.)	2 kgf (14.5 ft-lbs.)	3 kgf (21.7 ft-lbs.)	50 N
Starting torque	10 g-cm (0.14 oz.-inch)	10 g-cm (0.14 oz.-inch)	100 gf x cm (9.8 mN x m) max. (7.2 m ft x lbf)	100 g-cm (1.39 oz.-inch)
Degree of protection: IEC 144	IP50	IP50	IEC IP64	IEC60925 IP65
Ambient operating temperature	-10° to 55°C (14° to 131°F)	-10° to 70°C (14° to 158°F)	-10° to 70°C (14° to 158°F) with no icing	-10° to 70°C (14° to 158°F)
Shaft coupler	E69-C04B supplied; two 4 mm dia. shafts	E69-C06B supplied, two 6 mm dia. shafts. Optional couplers for 8 and 10 mm dia. shafts	Order separately. E69-C06B 6 mm; E69-C68B 6 to 8 mm; E69-C06M metal 6 mm	Order separately. Choose E69-C08B for the 8 mm dia. shaft

ENCODERS



E6D **E6C3-A** **E6CP** **E6F**

Dimensions mm (in)	55 dia x 50 L (2.17 x 1.97)	50 dia. x 38 L (1.97 x 1.50)	56 dia. x 50 L (2.21 x 1.97)	60 dia. x 60 L (2.36 x 2.36)
Shaft diameter mm (in)	6 (0.24)	8 (0.32)	6 (0.24)	10 (0.39)
Type	Incremental	Absolute	Absolute	Absolute
Features	<ul style="list-style-type: none"> • Super accuracy and high response frequency 	<ul style="list-style-type: none"> • CE approved and now available with PNP outputs for interfacing to allow more flexible interfacing to other devices • High resistance to shock • Drip-proof construction • Heavy duty absolute encoder 	<ul style="list-style-type: none"> • Reliable 8-bit resolution and gray code binary output 	<ul style="list-style-type: none"> • Gray code binary output with 8-bit resolution or BCD output with 10-bit resolution • Direct connections to high-speed counters, position control modules for PLCs or Omron's H8PS cam positioner
Resolution	720 to 6,000 pulses/revolution	256, 360, 720, 1,024 pulses/revolution	256 pulses/revolution	256 or 360 pulses/revolution
Output phase(s)	Outputs A, B, and Z (reversible)	Gray code	Gray code binary	Gray code binary or BCD (detects in gray-codes; converts to BCD)
Output phase difference	90°±25°	–	–	–
Maximum response frequency (pulses per second)	200 kHz (200,000 pulses/sec)	20 kHz (20,000 pulses per second)	5 kHz (5,000 pulses per second)	5 (E6F-AB3C) or 10 (E6F-AG5C) kHz (5,000 or 10,000 pulses per sec.)
Maximum rpm	12,000 rpm	5,000 rpm	1,000 rpm	5,000 rpm
Supply voltage	5 VDC (voltage output); 12 VDC (open collector output)	12 to 24 VDC	5 to 12 VDC (A6CP-AG3C); 12 to 24 VDC (E6CP-AG5C)	5 to 12 VDC (E6F-AB3C); 12 to 24 VDC (E6F-AG5C)
Current consumption	150 mA max.	70 mA	90 mA max. (A6CP-AG3C); 70 mA (E6CP-AG5C)	50 mA max (E6F-AB3C); 70 mA (E6F-AG5C)
Output form and capacity	35 mA max. (voltage and NPN open collector output)	35 mA (NPN and PNP open collector)	16 mA (NPN open collector transistor)	35 mA (NPN open collector transistor)
Shaft loading: radial	5 kgf (36.2 ft-lbs.); 2 kgf (14.5 ft-lbs.) typical	80 N	3 kgf (21.7 ft-lbs.)	10 kgf (72.3 ft-lbs.)
Shaft loading: axial	3 kgf (21.7 ft-lbs.); 1 kgf (7.2 ft-lbs.) typical	50 N	2 kgt (14.5 ft-lbs.)	3 kgf (21.7 ft-lbs.)
Starting torque	100 g-cm (1.39 oz.-inch)	100 g-cm (1.39 oz.-inch)	10 g-cm (0.14 oz.-inch)	100 g-cm (1.39 oz.-inch)
Degree of protection: IEC 144	IP50	IEC60925 IP65	IP50	IP52
Ambient operating temperature	-10° to 70°C (14 to 158°F)	-10° to 70°C (14° to 158°F)	-10° to 70°C (14 to 158°F)	-10° to 70°C (14° to 158°F)
Shaft coupler	E69-C06B supplied, two 6 mm dia. shafts	Order separately. Choose E69-C08B for the 8 mm dia. shaft	E6CP-AG3C - E-69-C06B supplied, two 6 mm dia. shafts. Optional couplers for 8 and 10 mm dia. shafts. E6CP-AG5C – Order separately. Choose 6 mm dia. couplers for 6, 8, 10 mm dia. shafts	2 options: For E6F-AG5C, order sep. Choose 6 mm dia. couplers for 6, 8 & 10 mm dia. shafts. For E6F-AB3C, E69-C06B supplied, Two 6 mm dia. shafts. Optional couplers for 8 & 10 mm dia. shafts

ULTRASONIC



E4A

E4B

E4C

E4E

E4R

Dimensions mm (in)	104 H x 50 W x 150 D (4.09 x 1.97 x 5.91)	61 H x 35 W x 79 D (2.40 x 1.38 x 3.11)	18 Dia. x 75 L (0.71 x 2.95)	36 H x 18 W x 25 D (1.42 x 0.71 x 0.98)	80 H x 46 W x 52D (3.15 x 1.81 x 2.05)
Amplifier type	Built-in amplifier	Built-in amplifier	Separate amplifier	Built-in amplifier	Separate amplifier
Features	Ultrasonic reflective; Mutual interference protection; Clear material detection; Photo sensitive film sensing	Ultrasonic through-beam and reflective; Narrow 8 degree beam; Zone and setting distance models	Ultrasonic through-beam and reflective; Compact threaded body; Mutual interference protection; Zone setting mode	Extremely compact self-contained ultrasonic sensor; Through-beam; Separate NO and NC models	Ultrasonic reflective sensor; Wide beam angle for granular and high viscosity materials
<i>Detection method and sensing distance</i>					
Through-beam type	–	1 m, 500 mm	500 mm	300 mm	–
Reflective	0.3 to 3 m	200 to 700 mm, 50 to 200 mm	100 to 350 mm	–	2.5 m
Supply voltage	120 and 240 VAC 12 to 24 VDC	12 to 24 VDC	12 to 24 VDC	12 to 24 VDC	12 VDC
<i>Control outputs</i>					
AC	3 A Relay, SPDT	–	–	–	4 A Relay, SPDT
DC	–	100 mA NPN or PNP open collector	100 mA, NPN/PNP open collector, selectable	100 mA, NPN open collector, NO or NC	–
Alarm	–	–	–	–	–
Response time	250 ms	10 ms	10 ms (200 Hz)	25 ms	150 ms
Materials	Plastic, ABS	Plastic, ABS	Plastic, ABS	Plastic, ABS	Plastic, ABS
Enclosure rating	IP60	IP66	IP66 sensor; IP40 amp.	IP66	IP10

Pushbuttons, Switches and Pilot Devices

Omron Smart Solutions

Pushbuttons

Easy-to-install illuminated and non-illuminated switches are available with momentary and alternate action types.

Switches

Selector switches and key switches are available in two- and three-position versions.







Pilot Devices









Indicator lights and buzzers help operators monitor status effectively.



22 mm Pushbuttons, Switches and Pilot Devices

NON-ILLUMINATED

Shape	Pushbutton								Selector Switch
	Round Flush	Round Extended	Round Full-Guard	Round Half-Guard	30 mm Mushroom	40 mm Mushroom	Square Extended	Square Full-Guard	2- or 3-position knob
Part number	A22-F	A22-T	A22-G	A22-H	A22-S	A22-M	A22-C	A22-D	A22S
Appearance									
Color	◆◆◆◆◆◆◆◆	◆◆◆◆◆◆◆◆	◆◆◆◆◆◆◆◆	◆◆◆◆◆◆◆◆	◆◆◆◆◆◆◆◆	◆◆◆◆◆◆◆◆	◆◆◆◆◆◆◆◆	◆◆◆◆◆◆◆◆	◆









Shape	Selector Switch Extended Lever	Key Switch	Emergency Stop						
	2- or 3-position knob	2- or 3-position knob	Push-pull 40 mm dia.	Push-pull 60 mm dia.	Push-lock, turn-reset 30 mm dia.	Push-lock, turn-reset 40 mm dia.	Push-lock, turn-reset 60 mm dia.	Push-lock, key-reset 30 mm dia.	Push-lock, key-reset 40 mm dia.
Part number	A22S	A22K	A22E-MP	A22E-LP	A22E-S	A22E-M	A22E-L	A22E-SK	A22E-MK
Appearance									
Color	◆	◆	◆	◆	◆	◆	◆	◆	◆

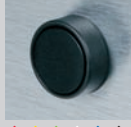

ILLUMINATED

Shape	Pushbutton					Selector Switch	Pilot Light	Emergency Stop
	Round Extended	Round Half-Guard	Round Full-Guard	Square Extended	Square Full-Guard	2- or 3-position knob	Round	Square
Part number	A22L-T	A22L-H	A22L-G	A22L-C	A22L-D	A22W	M22-F	M22-C
Appearance								
Color	◆◆◆◆◆◆◆◆	◆◆◆◆◆◆◆◆	◆◆◆◆◆◆◆◆	◆◆◆◆◆◆◆◆	◆◆◆◆◆◆◆◆	◆◆◆◆◆◆◆◆	◆◆◆◆◆◆◆◆	◆◆◆◆◆◆◆◆

16 mm Pushbuttons, Switches and Pilot Devices





NON-ILLUMINATED

Shape	Pushbutton			Selector Switch			Key Switch		
Part number	Round A165-T	Square A165-A	Rectangle A165-J	Round 2- or 3- position knob A165S-T	Square 2- or 3- position knob A165S-A	Rectangular 2- or 3- position knob A165S-J	Round 2- or 3- position knob A165K-T	Square 2- or 3- position knob A165K-A	Rectangular 2- or 3- position knob A165K-J
Appearance									
Color	◆ ◆ ◆ ◆ ◆ ◆ ◆ ◆ ◆ ◆	◆ ◆ ◆ ◆ ◆ ◆ ◆ ◆ ◆ ◆	◆ ◆ ◆ ◆ ◆ ◆ ◆ ◆ ◆ ◆	◆	◆	◆	◆	◆	◆

Shape	Buzzer	Emergency Stop
Part number	Rectangular Standard and high sound M2BJ	Push-lock, turn-reset A165E-S
Appearance		
Color	◆	◆ Also available: 40 mm dia. A165E-M

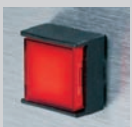
NOTE:
A16 - IP40
A165 - IP65 oiltight

ILLUMINATED

Shape	Pushbutton			Selector Switch		
Part number	Round A165L-T	Square A165L-A	Rectangle A165L-J	Round 2- or 3- position knob A165W-T	Square 2- or 3- position knob A165W-A	Rectangular 2- or 3- position knob A165W-J
Appearance						
Color	◆ ◆ ◆ ◆ ◆ ◆ ◆ ◆ ◆ ◆	◆ ◆ ◆ ◆ ◆ ◆ ◆ ◆ ◆ ◆	◆ ◆ ◆ ◆ ◆ ◆ ◆ ◆ ◆ ◆	◆ ◆ ◆ ◆	◆ ◆ ◆ ◆	◆ ◆ ◆ ◆

Shape	Pilot Lights			Emergency Stop
Part number	Round M165-T	Square M165-A	Rectangle M165-J	Push-lock, turn reset 30 mm dia. A165E-LS
Appearance				
Color	◆ ◆ ◆ ◆ ◆ ◆ ◆ ◆ ◆ ◆	◆ ◆ ◆ ◆ ◆ ◆ ◆ ◆ ◆ ◆	◆ ◆ ◆ ◆ ◆ ◆ ◆ ◆ ◆ ◆	◆ Also available: 40 mm dia. A165E-LM

NOTE:
A16 - IP40
A165 - IP65 oiltight

Power Supplies

Omron Smart Solutions

FUL

HLF

S8VS

Slim DIN track-mounting power supplies from 15 to 240 W are UL508 listed for operation at full rating. Digital display and preventive maintenance output available for load duration and power supply service life.



Versatile power supplies offer 3 W to 100 W output in a wide range of voltages for general industrial applications. DIN track and bolt-on mounting.



S82K

S8TS

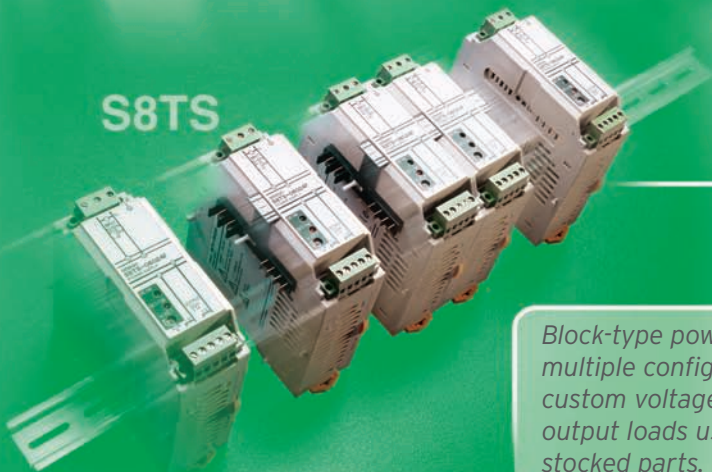

Block-type power supply allows multiple configurations for custom voltages or mixed output loads using a few easily stocked parts.

POWER SUPPLIES



S8VS

S82K

S8PS

S8TS

Features

- Small sized, DIN rail mount power supply with LED display
- Suitable for any application and any environment
- Digital displays to predict and schedule maintenance for improved uptime

- DIN rail mount power supply with a wide power range
- Suitable for general purpose and rugged industrial applications
- Lightweight for easy DIN rail mount installation

- Compact DIN rail mounting industrial power supply with high power capacity
- Slim metal housing designed for rugged industrial application
- A versatile unit that could be installed in many different ways

- High-end, block type power supply easily connects with multiple units and offers many output configurations
- Ideal for applications where increase of power may be required

Mounting

DIN rail

DIN rail / Bolt-on

DIN rail / Bolt-on

DIN rail

Product type

Enclosed frame with metal and plastic housing

Enclosed frame with plastic housing

Open or covered frame with metal housing

Plastic housing, block-style configuration

Output

Single output

Single and dual output

Single output

Configures to user's choice

Power ratings

15, 30, 60, 90, 120, 180 and 240 W

3, 7.5, 15, 30, 50, 90 and 100 W

50, 100, 150, 300 and 600 W

25 W, 30 W, and 60 W per single unit; Expandable up to 240 W by ganging the units together

Output voltage/current

24 V: 2.5 A, 3.75 A, 5 A, 7.5 A, 10 A

5 V: 0.6A, 1.5A, 2.5A, 5.0A; 12 V: 0.25A, 0.6A, 1.2A, 2.5A; 15 V: 0.2A, 0.5A; 24 V: 0.13A, 0.3A, 0.6A, 1.3A, 2.1A, 3.75A, 4.2A, ±12 V/+0.3/-0.2A; ±15 V/+0.2/-0.2A

5 V: 10 A; 12 V: 4.2 A; 24 V: 2.1 A, 4.5 A, 6.5 A, 14 A, 27 A

5 V: 5 A, 12 V: 2.5 A, 24 V: 2.5 A (this is per unit values); When ganged together, values could go up to 12 V: 10 A, 24 V: 10 A

Input voltage

85 to 264 VAC, 47 to 450 Hz

85 to 264 VAC, 47 to 450 Hz; 85 to 132 VAC, 170 to 264 VAC (selectable), 85 to 253 VAC, 47 to 450 Hz (selectable)

85 to 264 VAC, 47 to 450 Hz

85 to 264 VAC, 47 to 63 Hz

Dimensions mm (in)

60 W:
95 H x 40 W x 108.3 D
(3.74 x 1.57 x 4.26)
90 W:
115 H x 50 W x 121.3 D
(4.53 x 1.97 x 4.78)
120 W:
115 H x 50 W x 121.3 D
(4.53 x 1.97 x 4.78)
180 W:
115 H x 75 W x 125.3 D
(4.53 x 2.95 x 4.93)
240 W:
115 H x 100 W x 125.3 D
(4.53 x 3.94 x 4.93)

3 W, 7.5 W:
75 H x 37.5 W x 65 D
(2.95 x 1.48 x 2.56);
15 W:
75 H x 45 W x 96 D
(2.95 x 1.77 x 3.78);
30 W, 50 W:
75 H x 90 W x 96 D
(2.95 x 3.54 x 3.78);
90 W, 100 W:
75 H x 145 W x 96 D
(2.95 x 5.71 x 3.78)

50 W:
85 H x 40 W x 127 D
(3.35 x 1.57 x 5.0);
100 W:
92 H x 50 W x 145 D
(3.62 x 1.97 x 5.71);
150 W:
92 H x 50 W x 163 D
(3.62 x 1.97 x 6.42);
300 W:
92 H x 110 W x 175 D
(3.62 x 4.33 x 6.89);
600 W:
92 H x 170 W x 179 D
(3.62 x 6.69 x 7.05)

120 H x 43 W x 120 D
(4.72 x 1.69 x 4.72)

Display/indication

3-digit, 7-segment LED; LED status displays for output voltage, output current, peak current, lifetime years, run time hours

Two LED lights; one for power-on indicator and the other for output-on indicator

LED light for output-on indicator

Two LED lights; one for power-on indicator and the other for output-on indicator

Alarm output

90, 120, 180, 240 W models with display have NPN outputs

Relay output available on 90 and 100 W models.

None

NPN output for when the output voltage drops

Approvals

cULus, UL508 listed, Class 2 output (60 W only), CE, SEMI F47-0200

UL508 listed, Class 2 output (up to 90 W), CSA, CE

UL508 listed, CSA, VDE, CE

cULus, UL508 listed, VDE, CE

Timers, Counters, and Panel Meters

Omron Smart Solutions

Digital 1/16 DIN counter with preset, total, batch and dual counting functions offers bi-color display to alert changes in output status. NEMA 4/IP66 front panel needs no additional protection.

H7CX Counters



Digital multifunction timer in 1/16 DIN size has a shallow mounting depth and NEMA 4/IP66 front panel without additional protection. Bi-color present value display can change from red to green to alert changes in output status.

H5CX Timers



Digital Panel Meters

Display the results of analog inputs and get control outputs indicating good/no good status with Omron's 1/8 DIN size process, temperature, rate and weight meters.



22451209464120432462498778346742964-28482047594089475346

TIMERS



H5CX

H3CA

H5BR

H3CR-A

H3CR-F

Dimensions mm (in)

48 H x 48 W x 100 D
(1.89 x 1.89 x 3.94)

48 H x 48 W x 63.7 D
(1.89 x 1.89 x 2.51)

72 H x 72 W x 100 D
(2.83 x 2.83 x 3.94)

48 H x 48 W x 68 D
(1.89 x 1.89 x 2.68)

48 H x 48 W x 66 D
(1.89 x 1.89 x 2.62)

Features

- Advanced programmable display with twin timer function
- PNP/NPN input
- Programmable via front or dip switches on back
- NEMA 4 front

- Digital set, solid-state timer
- LCD time remaining bar graph and output status indicators
- Switch selectable time unit, control mode and time limit setting
- 1/16 DIN plug-in unit

- Batch counting function records the number of completed cycles
- Nine field-selectable timing modes
- Scroll-through menus access from front panel

- Shallow mounting depth and wide range of panel covers
- Analog set, 1/16 DIN sized solid-state timer
- NPN/PNP input
- Wide AC/DC supply voltage

- Analog set, solid-state timer with combinations of independent ON/OFF time settings in a compact 1/16 DIN size
- Models with ON start or OFF start operating functions
- Fits standard 8- or 11-pin sockets

Product type

Multi-mode

ON-delay/Multi-mode

Multi-mode

ON-delay and one-shot Interval/Multi-mode

Twin timer

Control outputs

Time limit - SPDT, 5A at 250 VAC, Transistor, NPN, 100 mA at 30 VDC

Time limit - DPDT or SPDT, 3A 250 VAC; Instantaneous - SPDT, 3A, 250 VAC (H3CA-8H only)

1 SPDT relay and 2 NPN open collector transistor outputs

Time limit - DPDT, 5A, 250 VAC Transistor, 100 mA, 30 VDC (PNP/NPN) Instantaneous - DPDT, 5A, 250 VAC Transistor, 100 mA, 30 VDC (NPN/PNP)

Time limit - DPDT, 5A, 250 VAC; Instantaneous - DPDT, 5A, 250 VAC

Operation modes

12 selectable modes including ON-delay, repeat cycle, signal OFF-delay, interval, cumulative, ON/OFF duty adjustable cycle, twin timer

8 selectable modes including ON-delay only or multi-mode model with ON-delay, repeat cycle, signal interval/OFF-delay, 2 types of signal OFF-delay, interval, cycle and signal ON-delay/OFF-delay

9 selectable modes including ON-delay, repeat cycle, signal OFF-delay, interval, cumulative

Select 2-4-6 function models including ON-delay and one-shot, interval or selectable ON-delay, repeat cycle (two types), signal ON/OFF delay, signal OFF delay, interval

Repeat cycle: Independent ON or OFF time

Ranges

0.001 second to 9999 hours

0.1 second to 9990 hours (field selectable time units from 0.1 sec to 10 h x 3 digits)

0.001 second to 9999 hours (field selectable)

0.05 second to 300 hours or 0.1 second to 600 hours

0.05 second to 30 hours; 1.2 second to 300 hours

Display/indication

4-digit negative transmissive LCD; Programmable display color for output indication

LCD output status and percent time remaining bar graph

Alphanumeric 4-digit LCD display has 12 mm high characters and built-in backlight

Power ON, Output ON LEDs

Output ON and Output OFF LEDs

Supply voltage

100 to 240 VAC or 24 VAC / 12 to 24 VDC

24 to 240 VAC, 50/60 Hz and 12 to 240 VDC (8-pin model) 24, 100/110/120, 200/220/240 VAC, 50/60 Hz 12, 24, 48, 110 VDC

100 to 240 VAC, 50/60 Hz or 24 VAC, 50/60 HZ and 12 to 24 VDC

AC 100 – 240/ DC 100-125; DC 24 to 48/ DC 12 - 48

100 to 240 VAC, 50/60 Hz 12 VDC; 24 VAC/VDC

Mounting

Panel, track, surface

Panel, track, surface

Panel

Panel, track, surface

Panel, track, surface

Accessories

Sockets, panel mounting adapter, DIN rail

Sockets, protective covers, adapters for panel mounting, DIN rail

NEMA 4 waterproof cover, soft cover, shock prevention terminal cover

Sockets, panel covers in three colors, time setting ring, protective covers, adapters for panel mounting, DIN rail

Sockets, panel covers in three colors, time setting ring, protective covers, adapters for panel mounting, DIN rail

Approvals





cULus, cURus, CE

UL, CSA, SEV

UL, CSA, SEV, CE

UL, CSA, SEV, CE, VDE

UL, CSA, CE (LV)

TIMERS				
				
	H3DE	H3YN	H5S	H5L
Dimensions mm (in)	75 H x 22.5 W x 100 D (2.95 x 0.89 x 3.94)	28 H x 21.5 W x 56.6 D (1.10 x 0.85 x 2.23)	72 H x 72 W x 49 D (2.83 x 2.83 x 1.93)	96 H x 96 W x 56.5 D (3.78 x 3.78 x 2.22)
Features	<ul style="list-style-type: none"> • Slim analog set timers with field-selectable ranges and multiple operation modes • Built-in DIN rail clamp for easy track mounting 	<ul style="list-style-type: none"> • Subminiature analog solid-state time delay relay • Multiple time ranges and operating modes • Track solder terminal or wire-wrap terminal mounting via sockets • Fits MY socket 	<ul style="list-style-type: none"> • AM/PM display with 24 program steps and quartz accuracy • ON/OFF, cycle and pulse operations • LCD shows output status and current or next program step 	<ul style="list-style-type: none"> • Two independent 15-amp circuits • Manual override of outputs • Simple prompted programming • Fits 1/4 DIN panel cut out
Product type	Multi-mode	ON-delay/Interval/Repeat Cycle	Weekly timer	Weekly timer
Control outputs	Time limit - SPDT, 5A, 250 VAC or SPDT x 2 - programmable between time limiting and instantaneous	Time limit - DPDT, 5A, 250 VAC; 4PDT, 3A, 250 VAC	Time limit - SPST x 2, 15A, 250 VAC	Time limit - 15A, 125 VAC
Operation modes	ON-delay, Repeat cycle/signal OFF start, Repeat cycle/signal ON start, Signal ON/OFF-delay, Signal OFF-delay, Interval, one shot	ON-delay/Interval/Repeat Cycle	ON/OFF, repeat cycle, pulse	Repeat cycle, individual program for each circuit
Ranges	0.1 second to 120 hours	0.1 second to 10 minutes or 0.1 minute to 10 hours	1 week	1 minute to 23 hours 59 minutes
Display/indication	Power and Output ON LEDs	Power ON LED; Time UP LED	LCD; time, day, output status, program step	LCD; day, time, program, circuit status
Supply voltage	24- 230 VAC/VDC	24, 100/120, 200/230 VAC; 50/60 Hz; 12, 24 VDC	100 to 240 VAC, 50/60 Hz	100 to 240 VAC, 50/60 Hz
Mounting	Track	Panel, track, surface	Panel, surface, track	Panel, track, surface
Accessories	DIN rail	Sockets, panel mounting adapter, DIN rail	Protective cover, track adapter, DIN rail	Protective cover, DIN rail
Approvals	UL, CSA, CE	UL, CSA, CE (LV)	UL, CSA	UL, CSA, SEV

COUNTERS



H7CX

H7BR

H7EC

H7ET

H7ER

Dimensions mm (in)

48 H x 48 W x 100 D
(1.89 x 1.89 x 3.94)

72 H x 72 W x 100 D
(2.83 x 2.83 x 3.94)

24 H x 48 W x 53.5 D
(0.94 x 1.89 x 2.11)

24.0 H x 48 W x 53.5 D
(0.94 x 1.89 x 2.11)

24.0 H x 48 W x 53.5 D
(0.94 x 1.89 x 2.11)

Features

- Advanced programmable display
- PNP/NPN input
- Prescaling function
- Up/down counting
- Programmable via front or dip switches on back
- NEMA 4 front

- Multi-function digital counter with backlit LCD display
- Single and double preset and \pm range
- Batch counter
- Contact and transistor outputs available

- 7 segment LCD with or without backlight
- Large display height 8.6 mm (0.338 in.)
- NEMA 4 front

- 7 segment LCD with or without backlight
- Large display height 8.6 mm (0.338 in.)
- NEMA 4 front

- 7 segment LCD with or without backlight
- Large display height 8.6 mm (0.338 in.)
- NEMA 4 front

Number of digits

4 or 6

6

8

7

4 or 5

Operation modes

UP, DOWN, reversible, tachometer, totalizer, dual-counter, batch, single or dual presets

UP, DOWN, reversible

UP counting

UP counting

UP counting

Counter input

NPN/PNP selectable

No voltage or voltage

PNP/NPN DC voltage; AC voltage; No-voltage contact

PNP/NPN DC voltage; AC voltage; No-voltage contact

PNP/NPN DC voltage; No voltage contact

Count speed

30 cps, 5 Kcps, 10 Kcps (prescale)

30 cps, or 1, 5, or 10 Kcps

20 cps (AC/DC voltage); 30 cps/1 Kcps selectable (NPN/PNP DC voltage)

1 sec.

1 Kcps or 10 Kcps; 1 pulse/rev., 60 pulses/rev., or 600 pulses/rev.

Ranges

0 to 9999 (4 digits) 0 to 999,999 (6 digits)

0 to 999,999 for preset models, and -99,999 to 999,999 for \pm

0 to 99,999,999

Selectable between 999,999.9 hrs. and 3,999 days 23.9 hrs.; 999 hrs. 59 min. 59 sec. and 9,999 hrs. 59.9 min.

0 to 1,000 rps; 1,000.0 rpm; 1,000.0 rps; 10,000 rpm

Supply voltage

100-240 VAC or 24 VAC / 12 to 24 VDC

100 to 240 VAC, 50/60 Hz or 24 VAC/ 12 to 24 VDC

Not required for non-backlight models; 24 VDC required for backlight models

Not required for non-backlight models; 24 VDC required for backlight models

Not required for non-backlight models; 24 VDC required for backlight models

Control output

Contact, transistor or both (programmable)

Contacts: 3A, 250 VAC; Transistor: Open collector, 100 mA at 30 VDC max. Residual voltage 2 V Max.

–

–

–

Connections

Screw terminals or 11-pin socket

Screw terminals

Screw terminals or wire wrap; 8 solder terminals

Screw terminals or wire wrap

Screw terminals

Mounting

Panel, track or surface

Flush mount

Panel

Panel

Panel

Approvals

cULus, cURus, CE

UL, CSA, CE

UL, CE, CSA, VDE

UL, CE, CSA, VDE

UL, CSA, CE, VDE

DIGITAL PANEL METERS



K3HB-S

K3HB-X

K3HB-H

K3HB-V

Dimension	48 H x 96 W x 95 D (1.89 x 3.78 x 3.74)	48 H x 96 W x 95 D (1.89 x 3.78 x 3.74)	48 H x 96 W x 95 D (1.89 x 3.78 x 3.74)	48 H x 96 W x 95 D (1.89 x 3.78 x 3.74)
Features	<ul style="list-style-type: none"> Advanced inspection controller with high speed response of 2,000 times per second This is ideal for high-speed measurement with discrimination from 1 or 2 independent analog inputs Sampling period is measured at 0.5 ms with an output response time of 1 ms max. 	<ul style="list-style-type: none"> Intelligent signal processor for AC or DC signal or voltage Multiple ranges can be covered by a single meter Programmable via serial communications or front panel Field replaceable output 	<ul style="list-style-type: none"> High-speed temperature indicator with high accuracy input resolution for both Platinum resistance and Thermocouples This unit is also equipped with simple input shift using two points, hysteresis, peak/hold value, and more 	<ul style="list-style-type: none"> Ideal weighing indicator for making good/no-good judgments Could measure pressure, load, torque, and weight by using load cell signal input
Product type	Linear Sensor Indicator	Process Meter	Temperature Meter	Weighing Meter
Input type	Dual analog inputs: DC current: 0-20 mA, 4-20 mA DC voltage: 0-5 V, 1-5 V, ± 5 V, ± 10 V	DC voltage: 199.99 V, 19,999 V, 1.9999 V, 1.0000 to 5.0000 V; AC voltage: 0.0 to 400.0 V, 0.00 to 199.99 V, 0.0000 to 1.9999 V; DC current: 199.99 mA, 19,999 mA, 1.9999 mA, 4.000 to 20.000 mA; AC current: 0.000 to 10.000 A, 0.0000 to 1.9999 A, 0.00 to 199.99 mA, 0.000 to 19.999 mA	Thermocouples: K, J, T, E, L, U, N, R, S, B, W; Platinum resistance: Pt100	DC voltage: 0.00 to 199.99 mV, 0.000 to 19.999 mV, ± 100.00 mV, ± 199.99 mV
Display	5-digit, 7-segment Negative Transmissive LCD	5-digit, 7-segment Negative Transmissive LCD	5-digit, 7-segment Negative Transmissive LCD	5-digit, 7-segment Negative Transmissive LCD
Setting Options	Front pushbuttons or Serial communications	Front pushbuttons or Serial communications	Front pushbuttons or Serial communications	Front pushbuttons or Serial communications
Event Inputs	5 point NPN; 8 point NPN; 5 point PNP; 8 point PNP	5 point NPN; 8 point NPN; 5 point PNP; 8 point PNP	5 point NPN; 8 point NPN; 5 point PNP; 8 point PNP	5 point NPN; 8 point NPN; 5 point PNP; 8 point PNP
Control outputs				
Combination output boards with Power Supply (PS)	SPDT and 12 VDC PS; SPDT and 10 VDC PS; 0-20 mA and 12 VDC PS; 0-20 mA and 10 VDC PS; 0-5, 0-10 VDC and 12 VDC PS; RS-232C and 12 VDC PS; RS-232C and 10 VDC PS; RS-485 and 12 VDC PS; RS-485 and 10 VDC PS	SPDT and 12 VDC PS; SPDT and 10 VDC PS; 0-20 mA and 12 VDC PS; 0-20 mA and 10 VDC PS; 0-5, 0-10 VDC and 12 VDC PS; RS-232C and 12 VDC PS; RS-232C and 10 VDC PS; RS-485 and 12 VDC PS; RS-485 and 10 VDC PS	SPDT and 12 VDC PS; SPDT and 10 VDC PS; 0-20 mA and 12 VDC PS; 0-20 mA and 10 VDC PS; 0-5, 0-10 VDC and 12 VDC PS; RS-232C and 12 VDC PS; RS-232C and 10 VDC PS; RS-485 and 12 VDC PS; RS-485 and 10 VDC PS	SPDT and 12 VDC PS; SPDT and 10 VDC PS; 0-20 mA and 12 VDC PS; 0-20 mA and 10 VDC PS; 0-5, 0-10 VDC and 12 VDC PS; RS-232C and 12 VDC PS; RS-232C and 10 VDC PS; RS-485 and 12 VDC PS; RS-485 and 10 VDC PS
Power Supply	12 VDC only or 10 VDC only	12 VDC only or 10 VDC only	12 VDC only or 10 VDC only	12 VDC only or 10 VDC only
Relay	2-SPDT; 4-SPST	2-SPDT; 4-SPST	2-SPDT; 4-SPST	2-SPDT; 4-SPST
Transistor	5-NPN; 5-PNP	5-NPN; 5-PNP	5-NPN; 5-PNP	5-NPN; 5-PNP
DeviceNet	Yes	Yes	Yes	Yes
Approvals	cULus, CE	cULus, CE	cULus, CE	cULus, CE

DIGITAL PANEL METERS



K3MA-J

K3MA-L

K3MA-F

Dimensions mm (in)	48 H x 96 W x 97 D (1.89 x 3.78 x 3.81)	48 H x 96 W x 97 D (1.89 x 3.78 x 3.81)	48 H x 96 W x 97 D (1.89 x 3.78 x 3.81)
Features	<ul style="list-style-type: none"> • Multi-range DC voltage/current input • Front-panel key operation • Scaling, front-panel forced-zero, zero-limit functions • Short 80 mm depth front panel • Water and dust-proof NEMA 4X front panel • 2-color LEDs 	<ul style="list-style-type: none"> • Wide input range • 2 types of platinum-resistance thermometers and 10 types of thermocouples • Front-panel key operation • Water and dust-proof NEMA 4X front panel • 2-color LEDs • Temperature input shift and temperature unit selection functions • Short 80 mm depth front panel 	<ul style="list-style-type: none"> • Wide input range: contact, NPN, PNP, or voltage pulse • Front-panel key operation • Scaling, auto-zero time, startup compensation time functions • Short 80 mm depth front panel • Water and dust-proof NEMA 4X front panel • 2-color LEDs
Product type	Process meter	Temperature meter	Frequency/rate meter
Input type	DC voltage: 1.000 to 3.000 V, 0.000 to 5.000 V, -5.000 to 5.000 V, -10.000 to 10.00 V; DC current: 4.00 to 20.00 mA, 0.00 to 20.00 mA	Thermocouple: K, J, T, E, L, U, N R, S, B RTD: Pt100, JPt100	Rotary pulse
Display	7-segment LCD backlit, red and green LEDs	7-segment LCD backlit, red and green LEDs	7-segment LCD backlit, red and green LEDs
Setting options	Front-panel key	Front-panel key	Front-panel key
Control outputs			
Relay	2 SPST-NO	1 SPDT	2 SPST-NO
Transistor	N/A	N/A	N/A
BDC	N/A	N/A	N/A
Linear	N/A	N/A	N/A
Alarm	N/A	N/A	N/A
Serial communications outputs	N/A	N/A	N/A
PC software	N/A	N/A	N/A
Approvals	cULus, CE	cULus, CE	cULus, CE

Terms and Conditions of Sales

1. **Definitions:** The words used herein are defined as follows.

- (a) **Terms:** These terms and conditions
 - (b) **Seller:** Omron Electronic Components LLC and its subsidiaries
 - (c) **Buyer:** The buyer of Products, including any end user in section III through VI
 - (d) **Products:** Products and/or services of Seller
 - (e) **Including:** Including without limitation
2. **Offer/Acceptance:** These Terms are deemed part of all quotations, acknowledgments, invoices, purchase orders and other documents, whether electronic or in writing, relating to the sale of Products by Seller. Seller hereby objects to any Terms proposed in Buyer's purchase order or other documents which are inconsistent with, or in addition to, these Terms.
3. **Distributor:** Any distributor shall inform its customer of the contents after and including section III of these Terms.

1. Prices/ Payment: All prices stated are current, subject to change without notice by Seller. Buyer agrees to pay the price in effect at time of shipment. Payments for Products received are due net 30 days unless otherwise stated in the invoice. Buyer shall have no right to set off any amounts against the amount owing in respect of this invoice.

- 2. Discounts:** Cash discounts, if any, will apply only on the net amount of invoices sent to Buyer after deducting transportation charges, taxes and duties, and will be allowed only if (a) the invoice is paid according to Seller's payment terms and (b) Buyer has no past due amounts owing to Seller.
- 3. Interest:** Seller, at its option, may charge Buyer 1.5% interest per month or the maximum legal rate, whichever is less, on any balance not paid within the stated terms.
- 4. Orders:** Seller will accept no order less than 200 U.S. dollars net billing.
- 5. Currencies:** If the prices quoted herein are in a currency other than U.S. dollars, Buyer shall make remittance to Seller at the then current exchange rate most favorable to Seller; provided that if remittance is not made when due, Buyer will convert the amount to U.S. dollars at the then current exchange rate most favorable to Seller available during the period between the due date and the date remittance is actually made.
- 6. Governmental Approvals:** Buyer shall be responsible for all costs involved in obtaining any government approvals regarding the importation or sale of the Products.
- 7. Taxes:** All taxes, duties and other governmental charges (other than general real property and income taxes), including any interest or penalties thereon, imposed directly or indirectly on Seller or required to be collected directly or indirectly by Seller for the manufacture, production, sale, delivery, importation, consumption or use of the Products sold hereunder (including customs duties and sales, excise, use, turnover and license taxes) shall be charged to and remitted by Buyer to Seller.
- 8. Financial:** If the financial position of Buyer at any time becomes unsatisfactory to Seller, Seller reserves the right to stop shipments or require satisfactory security or payment in advance. If Buyer fails to make payment or otherwise comply with these Terms or any related agreement, Seller may (without liability and in addition to other remedies) cancel any unshipped portion of Products sold hereunder and stop any Products in transit until Buyer pays all amounts, including amounts payable hereunder, whether or not then due, which are owing to it by Buyer. Buyer shall in any event remain liable for all unpaid accounts.
- 9. Cancellation; Etc:** Orders are not subject to rescheduling or cancellation unless Buyer indemnifies Seller fully against all costs or expenses arising in connection therewith.
- 10. Force Majeure:** Seller shall not be liable for any delay or failure in delivery resulting from causes beyond its control, including earthquakes, fires, floods, strikes or other labor disputes, shortage of labor or materials, accidents to machinery, acts of sabotage, riots, delay in or lack of transportation or the requirements of any government authority.
- 11. Shipping/ Delivery:** Unless otherwise expressly agreed in writing by Seller:

- (a) All sales and shipments of Products shall be FOB shipping point (unless otherwise stated in writing by Seller), at which point title to and all risk of loss of the Products shall pass from Seller to Buyer, provided that Seller shall retain a security interest in the Products until the full purchase price is paid by Buyer;
- (b) Delivery and shipping dates are estimates only; and
- (c) Seller will package Products as it deems proper for protection against normal handling and extra charges apply to special conditions.

12. Claims: Any claim by Buyer against Seller for shortage or damage to the Products occurring before delivery to the carrier must be presented in detail in writing to Seller within 30 days of receipt of shipment.

1. Suitability: IT IS THE BUYER'S SOLE RESPONSIBILITY TO ENSURE THAT ANY OMRON PRODUCT IS FIT AND SUFFICIENT FOR USE IN A MOTORIZED VEHICLE APPLICATION. BUYER SHALL BE SOLELY RESPONSIBLE FOR DETERMINING APPROPRIATENESS OF THE PARTICULAR PRODUCT WITH RESPECT TO THE BUYER'S APPLICATION INCLUDING (A) ELECTRICAL OR ELECTRONIC COMPONENTS, (B) CIRCUITS, (C) SYSTEM ASSEMBLIES, (D) END PRODUCT, (E) SYSTEM, (F) MATERIALS OR SUBSTANCES OR (G) OPERATING ENVIRONMENT. Buyer acknowledges that it alone has determined that the Products will meet their requirements of the intended use in all cases. Buyer must know and observe all prohibitions of use applicable to the Product/s.

- 2. Use with Attention:** The followings are some examples of applications for which particular attention must be given. This is not intended to be an exhaustive list of all possible use of any Product, nor to imply that any use listed may be suitable for any Product:
- (a) Outdoor use, use involving potential chemical contamination or electrical interference.
 - (b) Use in consumer Products or any use in significant quantities.

- (c) Energy control systems, combustion systems, railroad systems, aviation systems, medical equipment, amusement machines, vehicles, safety equipment, and installations subject to separate industry or government regulations.
- (d) Systems, machines, and equipment that could present a risk to life or property.

3. Prohibited Use: NEVER USE THE PRODUCT FOR AN APPLICATION INVOLVING SERIOUS RISK TO LIFE OR PROPERTY WITHOUT ENSURING THAT THE SYSTEM AS A WHOLE HAS BEEN DESIGNED TO ADDRESS THE RISKS, AND THAT THE PRODUCT IS PROPERLY RATED AND INSTALLED FOR THE INTENDED USE WITHIN THE OVERALL EQUIPMENT OR SYSTEM.

4. Motorized Vehicle Application: USE OF ANY PRODUCT/S FOR A MOTORIZED VEHICLE APPLICATION MUST BE EXPRESSLY STATED IN THE SPECIFICATION BY SELLER.

5. Programmable Products: Seller shall not be responsible for the Buyer's programming of a programmable Product.

1. Warranty: Seller's exclusive warranty is that the Products will be free from defects in materials and workmanship for a period of twelve months from the date of sale by Seller (or such other period expressed in writing by Seller). SELLER MAKES NO WARRANTY OR REPRESENTATION, EXPRESS OR IMPLIED, ABOUT ALL OTHER WARRANTIES, NON-INFRINGEMENT, MERCHANTABILITY OR FITNESS FOR A PARTICULAR PURPOSE OF THE PRODUCTS.

2. Buyer Remedy: Seller's sole obligation hereunder shall be to replace (in the form originally shipped with Buyer responsible for labor charges for removal or replacement thereof) the non-complying Product or, at Seller's election, to repay or credit Buyer an amount equal to the purchase price of the Product; provided that there shall be no liability for Seller or its affiliates unless Seller's analysis confirms that the Products were handled, stored, installed and maintained and not subject to contamination, abuse, misuse or inappropriate modification. Return of any Products by Buyer must be approved in writing by Seller before shipment.

3. Limitation on Liability: SELLER AND ITS AFFILIATES SHALL NOT BE LIABLE FOR SPECIAL, INDIRECT, INCIDENTAL OR CONSEQUENTIAL DAMAGES, LOSS OF PROFITS OR PRODUCTION OR COMMERCIAL LOSS IN ANY WAY CONNECTED WITH THE PRODUCTS, WHETHER SUCH CLAIM IS BASED IN CONTRACT, WARRANTY, NEGLIGENCE OR STRICT LIABILITY. FURTHER, IN NO EVENT SHALL LIABILITY OF SELLER OR ITS AFFILIATES EXCEED THE INDIVIDUAL PRICE OF THE PRODUCT ON WHICH LIABILITY IS ASSERTED.

4. Indemnities: Buyer shall indemnify and hold harmless Seller, its affiliates and its employees from and against all liabilities, losses, claims, costs and expenses (including attorney's fees and expenses) related to any claim, investigation, litigation or proceeding (whether or not Seller is a party) which arises or is alleged to arise from Buyer's acts or omissions under these Terms or in any way with respect to the Products.

1. Intellectual Property: The intellectual property embodied in the Products is the exclusive property of Seller and its affiliates and Buyer shall not attempt to duplicate it in any way without the written permission of Seller. Buyer (at its own expense) shall indemnify and hold harmless Seller and defend or settle any action brought against Seller to the extent that it is based on a claim that any Product made to Buyer specifications infringed intellectual property rights of another party.

2. Property/Confidentiality: Notwithstanding any charges to Buyer for engineering or tooling, all engineering and tooling shall remain the exclusive property of Seller. All information and materials supplied by Seller to Buyer relating to the Products are confidential and proprietary, and Buyer shall limit distribution thereof to its trusted employees and strictly prevent disclosure to any third party.

3. Performance Data: Performance data is provided as a guide in determining suitability and does not constitute a warranty. It may represent the result of Seller's test conditions, and the users must correlate it to actual application requirements.

4. Change In Specifications: Product specifications and description may be changed at any time based on improvements or other reasons. It is Seller's practice to change part numbers when published ratings or features are changed, or when significant engineering changes are made. However, some specifications of the Product may be changed without any notice.

5. Errors And Omissions: The information on Seller's website or in other documentation has been carefully checked and is believed to be accurate; however, no responsibility is assumed for clerical, typographical or proofreading errors or omissions.

6. Export Controls: Buyer shall comply with all applicable laws, regulations and licenses regarding (a) export of the Products or information provided by Seller; (b) sale of Products to forbidden or other proscribed persons or organizations; (c) disclosure to non-citizens of regulated technology or information.

1. Waiver: No failure or delay by Seller in exercising any right and no course of dealing between Buyer and Seller shall operate as a waiver of rights by Seller.

2. Assignment: Buyer may not assign its rights hereunder without Seller's written consent.

3. Law: These Terms are governed by Illinois law (without regard to conflict of laws). Federal and state courts in Illinois have exclusive jurisdiction for any dispute hereunder.

4. Amendment: These Terms constitute the entire agreement between Buyer and Seller relating to the Products, and no provision may be changed or waived unless in writing signed by the parties.

5. Severability: If any provision hereof is rendered ineffective or invalid, such provision shall not invalidate any other provision.

Omron Electronic Components Master Selection Guide...

Comprehensive and easy to use specifying tool for:

Electronic Components Master Selection Guide



Relays
Switches
Photomicrosensors
Micro Sensors
Connectors

Relays, The #1 Supplier In The World:

- MOS FET
- Low Signal
- RF/HF
- Power PCB
- Automotive
- General-Purpose
- Solid State

Switches:

- Snap Action
- Tactile
- DIP
- Dome Array
- Thumbwheel
- Rocker

Photomicrosensors:

- Slotted
- Reflective

Micro Sensors:

- Pressure
- Tilt
- Flow
- Shock/Vibration
- Clog Filter

Connectors

- FPC
- FFC

NEW

**Touch Sensing ICs
UWB Antennas**

OMRON
ELECTRONIC COMPONENTS

Request your copy and additional information
by visiting: www.components.omron.com, or
by calling us at: 847.882.2288
Monday through Friday 7:30 AM until 6:00 PM CST.



Omron Electronic Components: The Quality, Flexibility and Global Support You Need

For More Detailed Information...

Visit Us Online: www.components.omron.com

- Browse Omron's full range of Product information and selection guides.
- Search the cross-reference database to locate Omron component solutions.
- Find Omron solutions for competitive products.
- Locate a Distributor and search for available inventory.

Call Us:

1-847-882-2288 Monday through Friday,
7:30 a.m. to 6:00 p.m. Central Time (CT)

Email Us:

components@omron.com

OMRON ELECTRONICS COMPONENTS LLC

55 Commerce Drive • Schaumburg, IL 60173

www.components.omron.com

Компания «Океан Электроники» предлагает заключение долгосрочных отношений при поставках импортных электронных компонентов на взаимовыгодных условиях!

Наши преимущества:

- Поставка оригинальных импортных электронных компонентов напрямую с производств Америки, Европы и Азии, а так же с крупнейших складов мира;
- Широкая линейка поставок активных и пассивных импортных электронных компонентов (более 30 млн. наименований);
- Поставка сложных, дефицитных, либо снятых с производства позиций;
- Оперативные сроки поставки под заказ (от 5 рабочих дней);
- Экспресс доставка в любую точку России;
- Помощь Конструкторского Отдела и консультации квалифицированных инженеров;
- Техническая поддержка проекта, помощь в подборе аналогов, поставка прототипов;
- Поставка электронных компонентов под контролем ВП;
- Система менеджмента качества сертифицирована по Международному стандарту ISO 9001;
- При необходимости вся продукция военного и аэрокосмического назначения проходит испытания и сертификацию в лаборатории (по согласованию с заказчиком);
- Поставка специализированных компонентов военного и аэрокосмического уровня качества (Xilinx, Altera, Analog Devices, Intersil, Interpoint, Microsemi, Actel, Aeroflex, Peregrine, VPT, Syfer, Eurofarad, Texas Instruments, MS Kennedy, Miteq, Cobham, E2V, MA-COM, Hittite, Mini-Circuits, General Dynamics и др.);

Компания «Океан Электроники» является официальным дистрибьютором и эксклюзивным представителем в России одного из крупнейших производителей разъемов военного и аэрокосмического назначения «JONHON», а так же официальным дистрибьютором и эксклюзивным представителем в России производителя высокотехнологичных и надежных решений для передачи СВЧ сигналов «FORSTAR».



JONHON

«JONHON» (основан в 1970 г.)

Разъемы специального, военного и аэрокосмического назначения:

(Применяются в военной, авиационной, аэрокосмической, морской, железнодорожной, горно- и нефтедобывающей отраслях промышленности)

«FORSTAR» (основан в 1998 г.)

ВЧ соединители, коаксиальные кабели, кабельные сборки и микроволновые компоненты:

(Применяются в телекоммуникациях гражданского и специального назначения, в средствах связи, РЛС, а так же военной, авиационной и аэрокосмической отраслях промышленности).



Телефон: 8 (812) 309-75-97 (многоканальный)

Факс: 8 (812) 320-03-32

Электронная почта: ocean@oceanchips.ru

Web: <http://oceanchips.ru/>

Адрес: 198099, г. Санкт-Петербург, ул. Калинина, д. 2, корп. 4, лит. А