

IS65LV256AL IS62LV256AL



32K x 8 LOW VOLTAGE CMOS STATIC RAM

MAY 2012

FEATURES

- High-speed access time: 20, 45 ns
- Automatic power-down when chip is deselected
- CMOS low power operation
 - 17 μ W (typical) CMOS standby
 - 50 mW (typical) operating
- TTL compatible interface levels
- Single 3.3V power supply
- Fully static operation: no clock or refresh required
- Three-state outputs
- Industrial and Automotive temperatures available
- Lead-free available

DESCRIPTION

The *ISSI* IS62/65LV256AL is a very high-speed, low power, 32,768-word by 8-bit static RAM. It is fabricated using *ISSI*'s high-performance CMOS technology. This highly reliable process coupled with innovative circuit design techniques, yields access times as fast as 15 ns maximum.

When \overline{CE} is HIGH (deselected), the device assumes a standby mode at which the power dissipation is reduced to 150 μ W (typical) with CMOS input levels.

Easy memory expansion is provided by using an active LOW Chip Enable (\overline{CE}). The active LOW Write Enable (\overline{WE}) controls both writing and reading of the memory.

The IS62/65LV256AL is available in the JEDEC standard 28-pin SOJ, 28-pin SOP, and the 28-pin TSOP (Type I) package.

FUNCTIONAL BLOCK DIAGRAM



Copyright © 2012 Integrated Silicon Solution, Inc. All rights reserved. ISSI reserves the right to make changes to this specification and its products at any time without notice. ISSI assumes no liability arising out of the application or use of any information, products or services described herein. Customers are advised to obtain the latest version of this device specification before relying on any published information and before placing orders for products.

Integrated Silicon Solution, Inc. does not recommend the use of any of its products in life support applications where the failure or malfunction of the product can reasonably be expected to cause failure of the life support system or to significantly affect its safety or effectiveness. Products are not authorized for use in such applications unless Integrated Silicon Solution, Inc. receives written assurance to its satisfaction, that:

- a.) the risk of injury or damage has been minimized;
- b.) the user assume all such risks; and
- c.) potential liability of Integrated Silicon Solution, Inc is adequately protected under the circumstances

PIN CONFIGURATION
28-Pin SOJ/ 28-pin SOP

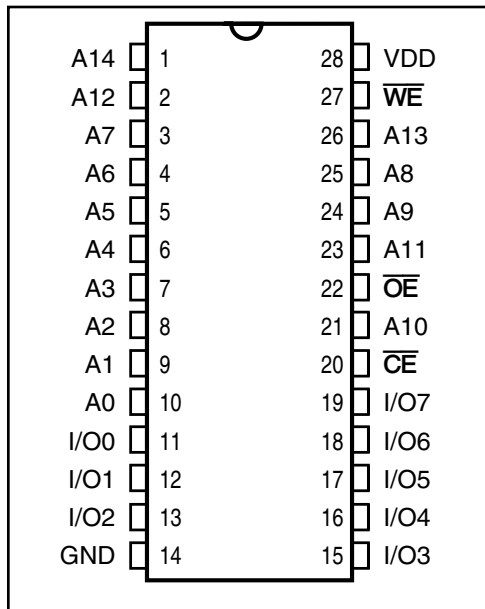

PIN CONFIGURATION
28-Pin TSOP

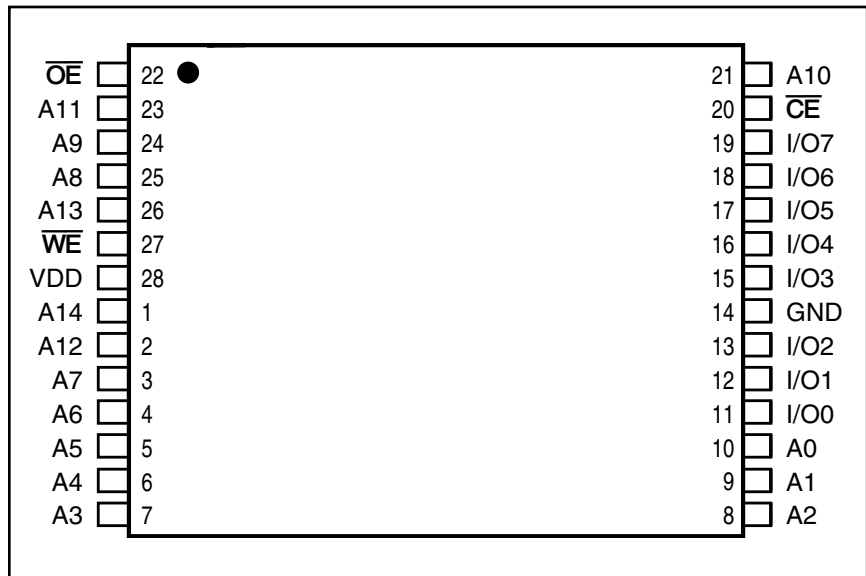

PIN DESCRIPTIONS

A0-A14	Address Inputs
\overline{CE}	Chip Enable Input
\overline{OE}	Output Enable Input
\overline{WE}	Write Enable Input
I/O0-I/O7	Input/Output
V _{DD}	Power
GND	Ground

TRUTH TABLE

Mode	\overline{WE}	\overline{CE}	\overline{OE}	I/O Operation	V _{DD} Current
Not Selected (Power-down)	X	H	X	High-Z	I _{SB1} , I _{SB2}
Output Disabled	H	L	H	High-Z	I _{CC1} , I _{CC2}
Read	H	L	L	DOUT	I _{CC1} , I _{CC2}
Write	L	L	X	DIN	I _{CC1} , I _{CC2}

ABSOLUTE MAXIMUM RATINGS⁽¹⁾

Symbol	Parameter	Value	Unit
V _{TERM}	Terminal Voltage with Respect to GND	-0.5 to +4.6	V
T _{BIAS}	Temperature Under Bias	-55 to +125	°C
T _{STG}	Storage Temperature	-65 to +150	°C
P _T	Power Dissipation	0.5	W
I _{OUT}	DC Output Current (LOW)	20	mA

Note:

1. Stress greater than those listed under ABSOLUTE MAXIMUM RATINGS may cause permanent damage to the device. This is a stress rating only and functional operation of the device at these or any other conditions above those indicated in the operational sections of this specification is not implied. Exposure to absolute maximum rating conditions for extended periods may affect reliability.

OPERATING RANGE

Part No.	Range	Ambient Temperature	V _{DD}
IS62LV256AL	Commercial	0°C to +70°C	3.3V +10%
IS62LV256AL	Industrial	-40°C to +85°C	3.3V ± 10%
IS65LV256AL	Automotive	-40°C to +125°C	3.3V ± 10%

DC ELECTRICAL CHARACTERISTICS (Over Operating Range)

Symbol	Parameter	Test Conditions	Min.	Max.	Unit
V _{OH}	Output HIGH Voltage	V _{DD} = Min., I _{OH} = -2.0 mA	2.4	—	V
V _{OL}	Output LOW Voltage	V _{DD} = Min., I _{OL} = 4.0 mA	—	0.4	V
V _{IH}	Input HIGH Voltage		2.2	V _{DD} + 0.3	V
V _{IL}	Input LOW Voltage ⁽¹⁾		-0.3	0.8	V
I _{LI}	Input Leakage	GND ≤ V _{IN} ≤ V _{DD}	Com. Ind. Auto.	-1 -2 -10	1 2 10 μA
I _{LO}	Output Leakage	GND ≤ V _{OUT} ≤ V _{DD} , Outputs Disabled	Com. Ind. Auto.	-1 -2 -10	1 2 10 μA

Notes:

1. V_{IL} = -3.0V for pulse width less than 10 ns.
2. Not more than one output should be shorted at one time. Duration of the short circuit should not exceed 30 seconds.

POWER SUPPLY CHARACTERISTICS⁽¹⁾ (Over Operating Range)

Symbol	Parameter	Test Conditions		-20 ns		-45 ns		Unit
				Min.	Max.	Min.	Max.	
I _{CC1}	V _{DD} Operating Supply Current	V _{DD} = Max., $\overline{CE} = V_{IL}$ I _{OUT} = 0 mA, f = 0	Com.	—	4	—	4	mA
			Ind.	—	5	—	5	
			Auto.	—	—	—	8	
I _{CC2}	V _{DD} Dynamic Operating Supply Current	V _{DD} = Max., $\overline{CE} = V_{IL}$ I _{OUT} = 0 mA, f = f _{MAX}	Com.	—	20	—	10	mA
			Ind.	—	25	—	12	
			Auto.	—	—	—	20	
			typ. ⁽²⁾	15	7			
I _{SB1}	TTL Standby Current (TTL Inputs)	V _{DD} = Max., V _{IN} = V _{IH} or V _{IL} $\overline{CE} \geq V_{IH}$, f = 0	Com.	—	1.5	—	1.5	mA
			Ind.	—	1.8	—	1.8	
			Auto.	—	—	—	2	
I _{SB2}	CMOS Standby Current (CMOS Inputs)	V _{DD} = Max., $\overline{CE} \leq V_{DD} - 0.2V$, V _{IN} > V _{DD} - 0.2V, or V _{IN} ≤ 0.2V, f = 0	Com.	—	15	—	15	μA
			Ind.	—	20	—	20	
			Auto.	—	—	—	50	
			typ. ⁽²⁾	2	2			

Note:

- At f = f_{MAX}, address and data inputs are cycling at the maximum frequency, f = 0 means no input lines change.
- Typical values are measured at V_{DD} = 3.3V, T_A = 25°C and not 100% tested.

CAPACITANCE^(1,2)

Symbol	Parameter	Conditions	Max.	Unit
C _{IN}	Input Capacitance	V _{IN} = 0V	6	pF
C _{OUT}	Output Capacitance	V _{OUT} = 0V	5	pF

Notes:

- Tested initially and after any design or process changes that may affect these parameters.
- Test conditions: T_A = 25°C, f = 1 MHz, V_{DD} = 3.3V.

READ CYCLE SWITCHING CHARACTERISTICS⁽¹⁾ (Over Operating Range)

Symbol	Parameter	-20 ns		-45 ns		Unit
		Min.	Max.	Min.	Max.	
t _{RC}	Read Cycle Time	20	—	45	—	ns
t _{AA}	Address Access Time	—	20	—	45	ns
t _{OHA}	Output Hold Time	2	—	2	—	ns
t _{ACE}	C _E Access Time	—	20	—	45	ns
t _{DOE}	O _E Access Time	—	10	—	25	ns
t _{LZOE⁽²⁾}	O _E to Low-Z Output	0	—	0	—	ns
t _{HZOE⁽²⁾}	O _E to High-Z Output	—	9	0	20	ns
t _{LZCE⁽²⁾}	C _E to Low-Z Output	3	—	3	—	ns
t _{HZCE⁽²⁾}	C _E to High-Z Output	—	9	0	20	ns
t _{PU⁽³⁾}	C _E to Power-Up	0	—	0	—	ns
t _{PD⁽³⁾}	C _E to Power-Down	—	18	—	30	ns

Notes:

1. Test conditions assume signal transition times of 3 ns or less, timing reference levels of 1.5V, input pulse levels of 0 to 3.0V and output loading specified in Figure 1.
2. Tested with the load in Figure 2. Transition is measured ±500 mV from steady-state voltage. Not 100% tested.
3. Not 100% tested.

AC TEST CONDITIONS

Parameter	Unit
Input Pulse Level	0V to 3.0V
Input Rise and Fall Times	3 ns
Input and Output Timing and Reference Levels	1.5V
Output Load	See Figures 1 and 2

AC TEST LOADS



Figure 1.

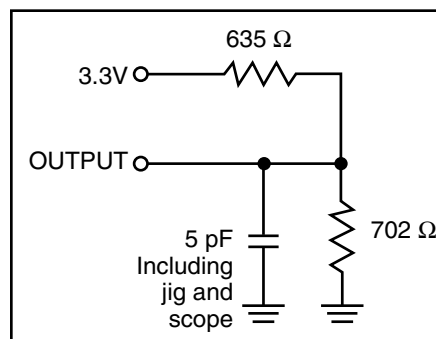

Figure 2.

AC WAVEFORMS

READ CYCLE NO. 1^(1,2)



READ CYCLE NO. 2^(1,3)



Notes:

1. \overline{WE} is HIGH for a Read Cycle.
2. The device is continuously selected. \overline{OE} , $\overline{CE} = V_{IL}$.
3. Address is valid prior to or coincident with \overline{CE} LOW transitions.

WRITE CYCLE SWITCHING CHARACTERISTICS^(1,3) (Over Operating Range)

Symbol	Parameter	-20 ns		-45 ns		Unit
		Min.	Max.	Min.	Max.	
t _{WC}	Write Cycle Time	20	—	45	—	ns
t _{SCE}	\overline{CE} to Write End	15	—	35	—	ns
t _{AW}	Address Setup Time to Write End	14	—	25	—	ns
t _{HA}	Address Hold from Write End	0	—	0	—	ns
t _{SA}	Address Setup Time	0	—	0	—	ns
t _{PWE⁽⁴⁾}	\overline{WE} Pulse Width	14	—	25	—	ns
t _{SD}	Data Setup to Write End	13	—	20	—	ns
t _{HD}	Data Hold from Write End	0	—	0	—	ns
t _{HZWE⁽²⁾}	\overline{WE} LOW to High-Z Output	—	8	—	20	ns
t _{LZWE⁽²⁾}	\overline{WE} HIGH to Low-Z Output	0	—	0	—	ns

Notes:

1. Test conditions assume signal transition times of 3 ns or less, timing reference levels of 1.5V, input pulse levels of 0 to 3.0V and output loading specified in Figure 1.
2. Tested with the load in Figure 2. Transition is measured ± 500 mV from steady-state voltage. Not 100% tested.
3. The internal write time is defined by the overlap of \overline{CE} LOW and \overline{WE} LOW. All signals must be in valid states to initiate a Write, but any one can go inactive to terminate the Write. The Data Input Setup and Hold timing are referenced to the rising or falling edge of the signal that terminates the Write.
4. Tested with \overline{OE} HIGH.

AC WAVEFORMS

WRITE CYCLE NO. 1 (\overline{WE} Controlled)^(1,2)



WRITE CYCLE NO. 2 (\overline{CE} Controlled)^(1,2)



Notes:

1. The internal write time is defined by the overlap of \overline{CE} LOW and \overline{WE} LOW. All signals must be in valid states to initiate a Write, but any one can go inactive to terminate the Write. The Data Input Setup and Hold timing are referenced to the rising or falling edge of the signal that terminates the Write.
2. I/O will assume the High-Z state if $\overline{OE} \geq V_{IH}$.

DATA RETENTION SWITCHING CHARACTERISTICS

Symbol	Parameter	Test Condition	Min.	Typ.	Max.	Unit
V_{DR}	V_{DD} for Data Retention	See Data Retention Waveform	2.0		3.6	V
I_{DR}	Data Retention Current	$V_{DD} = 2.0V$, $\overline{CE} \geq V_{DD} - 0.2V$ $V_{IN} \geq V_{DD} - 0.2V$, or $V_{IN} \leq V_{SS} + 0.2V$				μA
		Com.	—	—	15	
		Ind.	—	—	20	
		Auto. typ. ⁽¹⁾	—	—	50	
t_{SDR}	Data Retention Setup Time	See Data Retention Waveform	0		—	ns
t_{RDR}	Recovery Time	See Data Retention Waveform	t_{RC}		—	ns

Note:

1. Typical Values are measured at $V_{DD} = 3.3V$, $T_A = 25^\circ C$ and not 100% tested.

DATA RETENTION WAVEFORM (\overline{CE} Controlled)

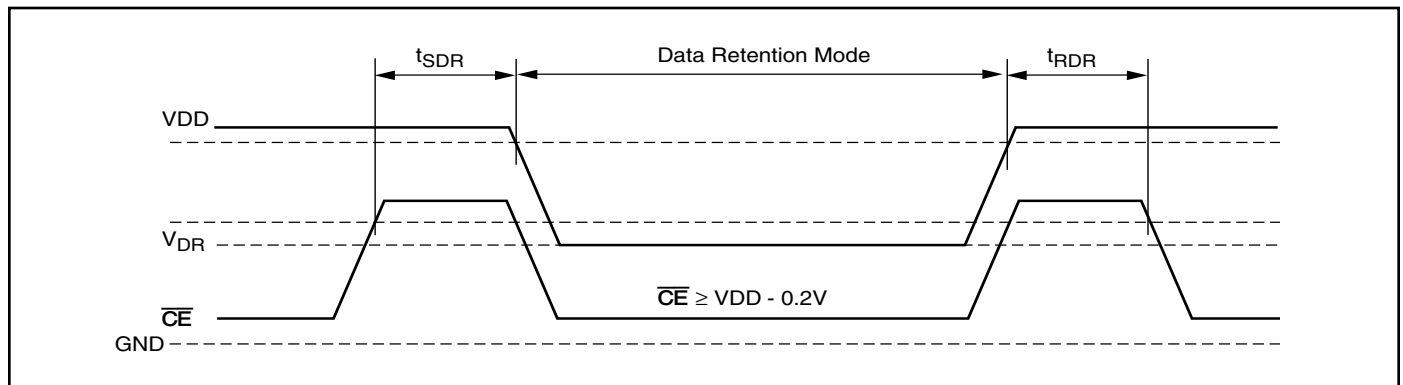

ORDERING INFORMATION

Commercial Range: 0°C to +70°C

Speed (ns)	Order Part No.	Package
20	IS62LV256AL-20T	TSOP
	IS62LV256AL-20TL	TSOP, Lead-free
	IS62LV256AL-20JL	300-mil Plastic SOJ, Lead-free
45	IS62LV256AL-45T	TSOP
	IS62LV256AL-45TL	TSOP, Lead-free

Industrial Range: -40°C to +85°C

Speed (ns)	Order Part No.	Package
20	IS62LV256AL-20TI	TSOP
	IS62LV256AL-20TLI	TSOP, Lead-free
	IS62LV256AL-20JLI	300-mil Plastic SOJ, Lead-free
45	IS62LV256AL-45TI	TSOP
	IS62LV256AL-45TLI	TSOP, Lead-free
	IS62LV256AL-45ULI	330-mil Plastic SOP, Lead-free

Automotive Range: -40°C to +125°C

Speed (ns)	Order Part No.	Package
45	IS65LV256AL-45TA3	TSOP
	IS65LV256AL-45TLA3	TSOP, Lead-free
	IS65LV256AL-45ULA3	330-mil Plastic SOP, Lead-free



SYMBOL	DIMENSION IN MM	
	MIN.	NOM. MAX.
A	3.05	3.76
A2	2.41	2.67
A3	0.64	1.09
b	0.36	0.56
b2	0.66	0.81
D	17.70	18.54
E	8.26	8.56
E1	7.42	7.75
E2	6.22	7.29
e	1.27 BSC	
ZD	0.95 REF.	
Y	0.1	

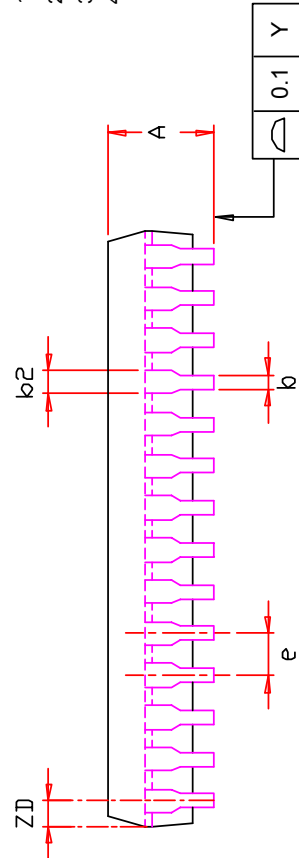
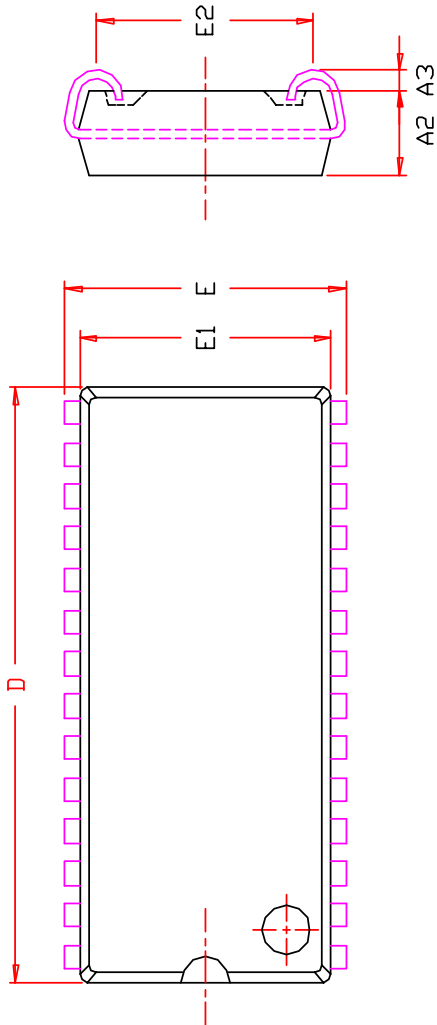

NOTE :

1. Controlling dimension : mm
2. Dimension D1 adh E do not include mold protrusion .
3. Dimension b2 does not include dambar protrusion/intrusion.
4. Formed leads shall be planar with respect to one another within 0.1mm at the seating plane after final test.

ISSI [®]	TITLE	28L 300mil SOJ Package Outline	REV.	C	DATE	07/05/2006
--------------------------	--------------	--	-------------	----------	-------------	------------

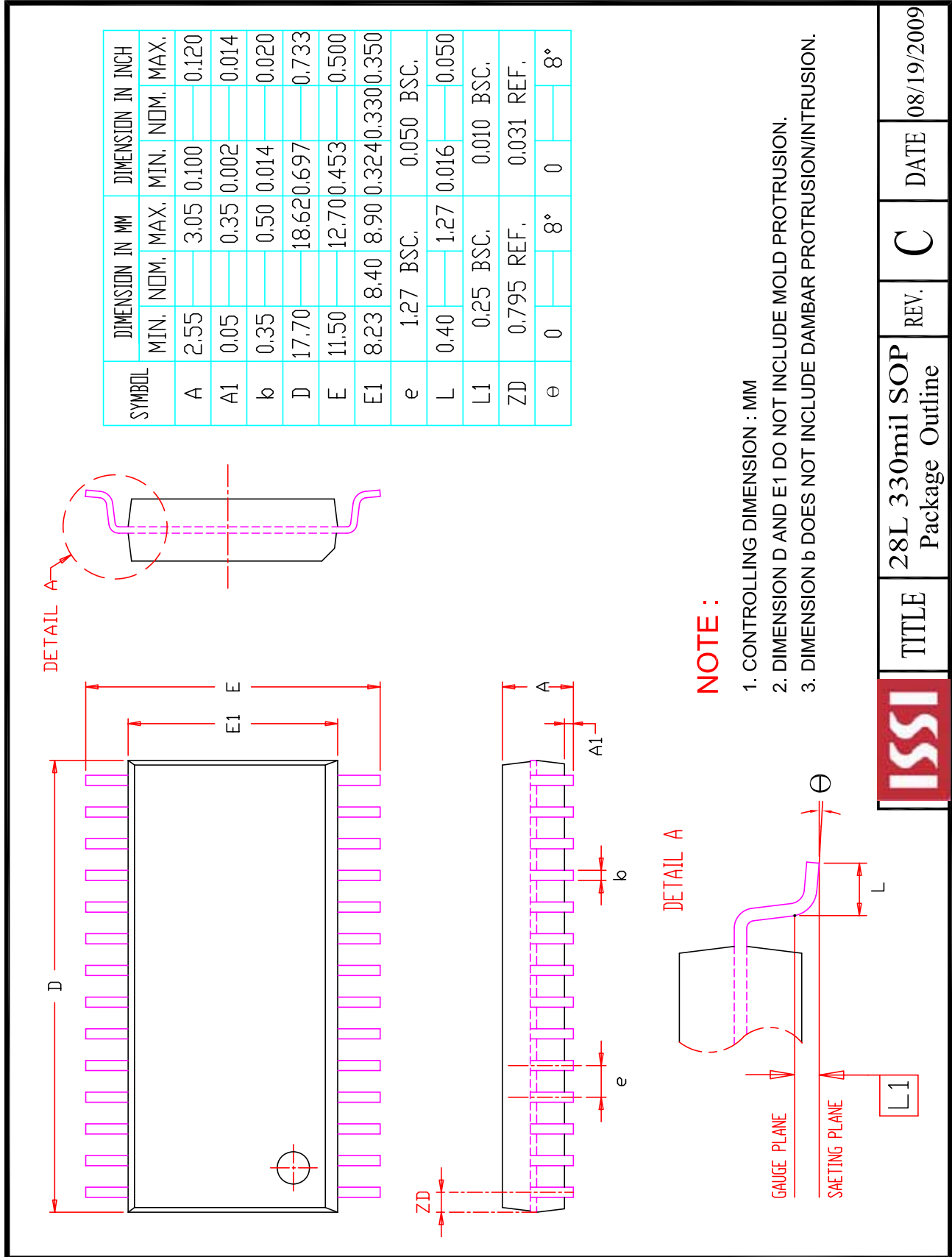

Компания «Океан Электроники» предлагает заключение долгосрочных отношений при поставках импортных электронных компонентов на взаимовыгодных условиях!

Наши преимущества:

- Поставка оригинальных импортных электронных компонентов напрямую с производств Америки, Европы и Азии, а так же с крупнейших складов мира;
- Широкая линейка поставок активных и пассивных импортных электронных компонентов (более 30 млн. наименований);
- Поставка сложных, дефицитных, либо снятых с производства позиций;
- Оперативные сроки поставки под заказ (от 5 рабочих дней);
- Экспресс доставка в любую точку России;
- Помощь Конструкторского Отдела и консультации квалифицированных инженеров;
- Техническая поддержка проекта, помощь в подборе аналогов, поставка прототипов;
- Поставка электронных компонентов под контролем ВП;
- Система менеджмента качества сертифицирована по Международному стандарту ISO 9001;
- При необходимости вся продукция военного и аэрокосмического назначения проходит испытания и сертификацию в лаборатории (по согласованию с заказчиком);
- Поставка специализированных компонентов военного и аэрокосмического уровня качества (Xilinx, Altera, Analog Devices, Intersil, Interpoint, Microsemi, Actel, Aeroflex, Peregrine, VPT, Syfer, Eurofarad, Texas Instruments, MS Kennedy, Miteq, Cobham, E2V, MA-COM, Hittite, Mini-Circuits, General Dynamics и др.);

Компания «Океан Электроники» является официальным дистрибьютором и эксклюзивным представителем в России одного из крупнейших производителей разъемов военного и аэрокосмического назначения «JONHON», а так же официальным дистрибьютором и эксклюзивным представителем в России производителя высокотехнологичных и надежных решений для передачи СВЧ сигналов «FORSTAR».



JONHON

«JONHON» (основан в 1970 г.)

Разъемы специального, военного и аэрокосмического назначения:

(Применяются в военной, авиационной, аэрокосмической, морской, железнодорожной, горно- и нефтедобывающей отраслях промышленности)

«FORSTAR» (основан в 1998 г.)

ВЧ соединители, коаксиальные кабели,
кабельные сборки и микроволновые компоненты:

(Применяются в телекоммуникациях гражданского и специального назначения, в средствах связи, РЛС, а так же военной, авиационной и аэрокосмической отраслях промышленности).



Телефон: 8 (812) 309-75-97 (многоканальный)

Факс: 8 (812) 320-03-32

Электронная почта: ocean@oceanchips.ru

Web: <http://oceanchips.ru/>

Адрес: 198099, г. Санкт-Петербург, ул. Калинина, д. 2, корп. 4, лит. А