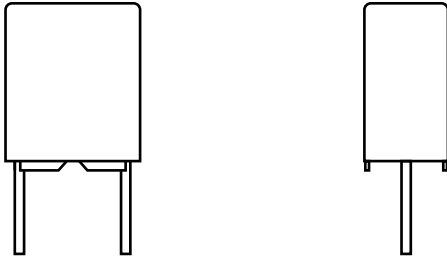

Interference Suppression Film Capacitor - Class X2 Radial MKT 310 V_{AC} - High Stability Grade

FEATURES

- 15 mm to 37.5 mm lead pitch
- Internal series construction
- AEC-Q200 qualified for C ≤ 470 nF
- Material categorization:
For definitions of compliance please see www.vishay.com/doc?99912

 AUTOMOTIVE
GRADE

RoHS
COMPLIANT

APPLICATIONS

High stability grade for continuous across the line X2 applications.

 See also application note: www.vishay.com/doc?28153

| QUICK REFERENCE DATA | |
|--|--|
| Capacitance range (E12 series) | 0.01 μ F to 2.2 μ F (preferred values acc. to E6) |
| Capacitance tolerance | $\pm 10\%$, $\pm 20\%$ ($\pm 5\%$ on request) |
| Rated AC voltage | 310 V _{AC} ; 50 Hz to 60 Hz |
| Permissible DC voltage | 800 V _{DC} at 85 °C 630 V _{DC} at 110 °C |
| Climatic testing class acc. to IEC 60068-1 | 40/110/56/C |
| Maximum application temperature | 110 °C |
| Reference standards | IEC 60384-14 and EN 60384-14 IEC 60065 pass. flamm. class C CSA-E384-14 UL 60384-14 |
| Dielectric | Polyester film |
| Electrodes | Metallized |
| Construction | Series construction  |
| Encapsulation | Plastic case, epoxy resin sealed, flame retardant UL-class 94 V-0 |
| Leads | Tinned wire |
| Marking | C-value; tolerance; rated voltage; sub-class; manufacturer's type; code for dielectric material; manufacturer location, year and week; manufacturer's logo or name; safety approvals |

Note

- For more detailed data and test requirements, contact rfi@vishay.com

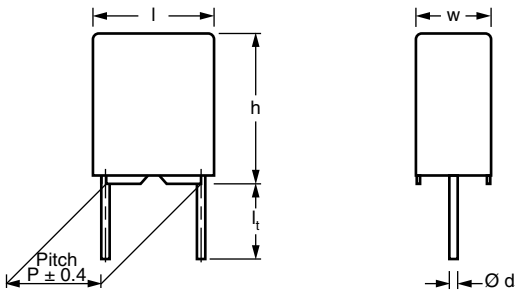
| DIMENSIONS in millimeters |
|--|
|  |

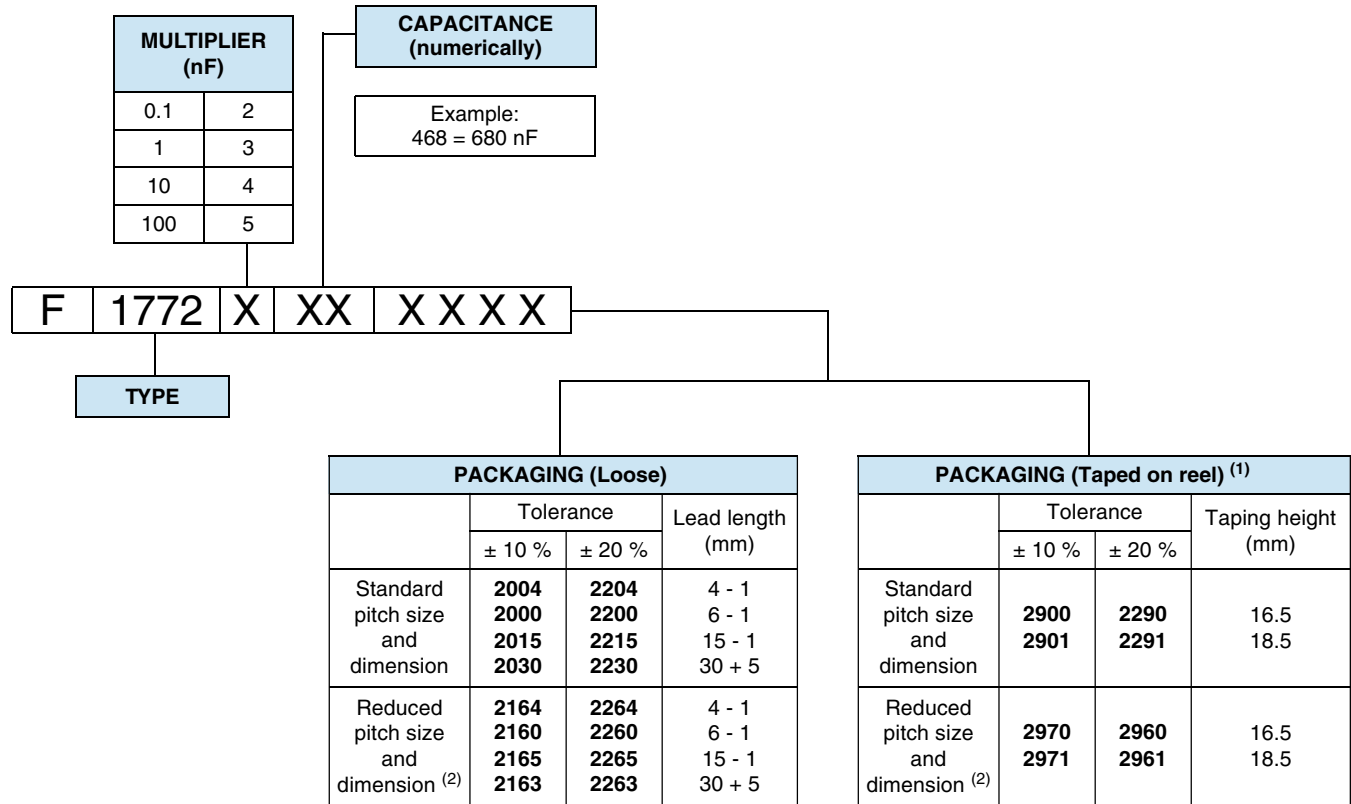
COMPOSITION OF CATALOG NUMBER

Example: F17724152215 means 0.15 μ F, \pm 20 %; standard pitch 22.5 mm; lead length 15 mm - 1 mm;
 F17724152265 means 0.15 μ F, \pm 20 %; reduced pitch 15.0 mm; lead length 15 mm - 1 mm

Notes

- For detailed tape specifications refer to packaging information www.vishay.com/doc?28139
- ⁽¹⁾ Taped on reel pitch \geq 27.5 mm is not available
- ⁽²⁾ Same capacitance values \geq 0.15 μ F are available in two different pitch sizes and dimensions

| SPECIFIC REFERENCE DATA | |
|--|------------------------------------|
| DESCRIPTION | VALUE |
| Rated AC voltage (U_{RAC}) | 310 V |
| Permissible DC voltage (U_{RDC}) | 630 V |
| Tangent of loss angle | $\leq 100 \times 10^{-4}$ at 1 kHz |
| Rated voltage pulse slope at $(dU/dt)_R$ 435 V_{DC} | 100 V/ μ s |
| R between leads, for $C \leq 0.33 \mu$ F at 100 V; 1 min | $> 15\,000 \text{ M}\Omega$ |
| RC between leads, $C > 0.33 \mu$ F at 100 V; 1 min | $> 5000 \text{ s}$ |
| R between leads and case; 100 V; 1 min | $> 30\,000 \text{ M}\Omega$ |
| Withstanding (DC) voltage (cut off current 10 mA) ⁽¹⁾ ; rise time $\leq 1000 \text{ V/s}$ | |
| $C \leq 0.47 \mu$ F | 2200 V; for 1 min |
| $C > 0.47 \mu$ F | 2150 V; for 1 min |
| Withstanding (AC) voltage between leads and case | 2120 V; 1 min |
| Maximum application temperature | 110 $^{\circ}$ C |

Note

- See "Voltage Proof Test for Metalized Film Capacitors": www.vishay.com/doc?28169





| ELECTRICAL DATA AND ORDERING INFORMATION | | | | | | |
|---|---|-----------------------------|---|--|--|---|
| U_{RAC} (V) | CAP. (μF) | PITCH (mm) | DIMENSIONS w x h x l MAX. (mm) | MASS ⁽³⁾ (g) | SPQ (pieces) SHORT LEAD | ORDERING CODE BULK LEAD LENGTH 6 mm - 1 mm ⁽¹⁾⁽²⁾ |
| 310 | d_t = 0.60 mm ± 0.06 mm; C-TOL. = ± 10 % | | | | | |
| | 0.010 | 15 | 5.0 x 11.0 x 17.5 | 1.4 | 750 | F17723102000 |
| | 0.012 | 15 | 5.0 x 11.0 x 17.5 | 1.4 | 750 | F17723122000 |
| | 0.015 | 15 | 5.0 x 11.0 x 17.5 | 1.4 | 750 | F17723152000 |
| | 0.018 | 15 | 5.0 x 11.0 x 17.5 | 1.4 | 750 | F17723182000 |
| | 0.022 | 15 | 5.0 x 11.0 x 17.5 | 1.4 | 750 | F17723222000 |
| | 0.027 | 15 | 5.0 x 11.0 x 17.5 | 1.4 | 750 | F17723272000 |
| | 0.033 | 15 | 5.0 x 11.0 x 17.5 | 1.4 | 750 | F17723332000 |
| | 0.039 | 15 | 6.0 x 12.0 x 17.5 | 2.0 | 500 | F17723392000 |
| | 0.047 | 15 | 6.0 x 12.0 x 17.5 | 2.0 | 500 | F17723472000 |
| | 0.056 | 15 | 6.0 x 12.0 x 17.5 | 2.0 | 500 | F17723562000 |
| | d_t = 0.80 mm ± 0.08 mm; C-TOL. = ± 10 % | | | | | |
| | 0.068 | 15 | 7.0 x 13.5 x 17.5 | 2.4 | 450 | F17723682000 |
| | 0.082 | 15 | 8.5 x 15.0 x 17.5 | 2.7 | 300 | F17723822000 |
| | 0.10 | 15 | 8.5 x 15.0 x 17.5 | 2.7 | 325 | F17724102000 |
| | 0.12 | 15 | 8.5 x 15.0 x 17.5 | 2.7 | 300 | F17724122000 |
| | 0.15 | 15 | 8.5 x 15.0 x 17.5 | 2.7 | 300 | F17724152160 |
| | 0.15 | 22.5 | 7.0 x 16.5 x 26.0 | 4.1 | 235 | F17724152000 |
| | 0.18 | 22.5 | 7.0 x 16.5 x 26.0 | 4.1 | 235 | F17724182000 |
| | 0.22 | 15 | 10.0 x 16.5 x 17.5 | 3.0 | 235 | F17724222160 |
| | 0.22 | 22.5 | 8.5 x 16.5 x 26.5 | 4.6 | 200 | F17724222000 |
| | 0.27 | 22.5 | 10.0 x 19.5 x 26.0 | 6.7 | 170 | F17724272000 |
| | 0.33 | 15 | 13.5 x 22.5 x 18.0 | 5.5 | 185 | F17724332160 |
| | 0.33 | 22.5 | 10.0 x 19.5 x 26.0 | 6.7 | 170 | F17724332000 |
| | 0.39 | 27.5 | 11.0 x 21.0 x 31.0 | 9.1 | 125 | F17724392000 |
| | 0.47 | 22.5 | 12.0 x 22.0 x 26.0 | 13.0 | 110 | F17724472160 |
| | 0.47 | 27.5 | 11.0 x 21.0 x 31.0 | 9.1 | 125 | F17724472000 |
| | 0.56 | 27.5 | 11.0 x 21.0 x 31.0 | 9.1 | 125 | F17724562000 |
| | 0.68 | 22.5 | 15.5 x 26.5 x 26.5 | 13.5 | 110 | F17724682160 |
| | 0.68 | 27.5 | 13.0 x 23.0 x 31.0 | 12.9 | 110 | F17724682000 |
| | 0.82 | 27.5 | 13.0 x 23.0 x 31.0 | 12.9 | 110 | F17724822000 |
| | 1.0 | 22.5 | 15.5 x 26.5 x 26.5 | 13.5 | 110 | F17725102160 |
| | 1.0 | 27.5 | 15.0 x 25.0 x 31.5 | 15.0 | 100 | F17725102000 |
| | 1.2 | 37.5 | 14.5 x 24.5 x 41.5 | 18.9 | 80 | F17725122000 |
| | 1.5 | 27.5 | 18.0 x 28.0 x 31.0 | 19.0 | 85 | F17725152160 |
| | 1.5 | 37.5 | 15.5 x 28.5 x 41.5 | 24.0 | 70 | F17725152000 |
| | 1.8 | 37.5 | 15.5 x 28.5 x 41.5 | 24.0 | 70 | F17725182000 |
| | 2.2 | 27.5 | 21.0 x 31.0 x 31.0 | 28.0 | 70 | F17725222160 |
| | 2.2 | 37.5 | 18.0 x 32.5 x 41.5 | 31.6 | 60 | F17725222000 |
| | d_t = 0.60 mm ± 0.06 mm; C-TOL. = ± 20 % | | | | | |
| | 0.010 | 15 | 5.0 x 11.0 x 17.5 | 1.4 | 750 | F17723102200 |
| | 0.015 | 15 | 5.0 x 11.0 x 17.5 | 1.4 | 750 | F17723152200 |
| | 0.022 | 15 | 5.0 x 11.0 x 17.5 | 1.4 | 750 | F17723222200 |
| | 0.033 | 15 | 5.0 x 11.0 x 17.5 | 1.4 | 750 | F17723332200 |
| | 0.047 | 15 | 5.0 x 11.0 x 17.5 | 1.4 | 750 | F17723472200 |
| 0.068 | 15 | 6.0 x 12.0 x 17.5 | 2.0 | 600 | F17723682200 | |
| 0.10 | 15 | 6.0 x 12.0 x 17.5 | 2.0 | 600 | F17724102200 | |

| ELECTRICAL DATA AND ORDERING INFORMATION | | | | | | |
|---|----------------------------|-----------------------------|---|--|--|---|
| U_{RAC} (V) | CAP. (μF) | PITCH (mm) | DIMENSIONS w x h x l MAX. (mm) | MASS ⁽³⁾ (g) | SPQ (pieces) SHORT LEAD | ORDERING CODE BULK LEAD LENGTH 6 mm - 1 mm ⁽¹⁾⁽²⁾ |
| d_t = 0.80 mm ± 0.08 mm; C-TOL. = ± 20 % | | | | | | |
| 310 | 0.15 | 15 | 8.5 x 15.0 x 17.5 | 2.7 | 325 | F17724152260 |
| | 0.15 | 22.5 | 6.0 x 15.5 x 26.0 | 3.3 | 260 | F17724152200 |
| | 0.22 | 15 | 10.0 x 16.5 x 17.5 | 4.5 | 300 | F17724222260 |
| | 0.22 | 22.5 | 7.0 x 16.5 x 26.0 | 4.1 | 235 | F17724222200 |
| | 0.33 | 15 | 13.5 x 22.5 x 18.0 | 5.5 | 185 | F17724332260 |
| | 0.33 | 22.5 | 8.5 x 18.0 x 26.0 | 5.3 | 190 | F17724332200 |
| | 0.47 | 22.5 | 10.0 x 19.5 x 26.0 | 6.7 | 170 | F17724472260 |
| | 0.47 | 27.5 | 9.0 x 19.0 x 31.5 | 6.8 | 160 | F17724472200 |
| | 0.68 | 22.5 | 12.0 x 22.0 x 26.0 | 13.4 | 110 | F17724682260 |
| | 0.68 | 27.5 | 11.0 x 21.0 x 31.0 | 12.9 | 125 | F17724682200 |
| | 1.0 | 22.5 | 15.5 x 26.5 x 26.5 | 13.5 | 110 | F17725102260 |
| | 1.0 | 27.5 | 15.0 x 25.0 x 31.5 | 15.0 | 100 | F17725102200 |
| | 1.5 | 27.5 | 18.0 x 28.0 x 31.5 | 19.0 | 85 | F17725152260 |
| | 1.5 | 37.5 | 14.5 x 24.5 x 41.5 | 18.9 | 80 | F17725152200 |
| | 2.2 | 27.5 | 21.0 x 31.0 x 31.0 | 28.0 | 70 | F17725222260 |
| 2.2 | 37.5 | 15.5 x 28.5 x 41.5 | 24.0 | 70 | F17725222200 | |

Notes

- SPQ = Standard Packing Quantity
- For detailed tape specifications refer to packaging information: www.vishay.com/doc?28139
- (1) For further packaging see table "Composition of Catalog Number".
- (2) Further information about packaging quantities with different lead length and/or taped versions, see document "Packing Quantities" www.vishay.com/doc?27608
- (3) Weight for short lead product only

| APPROVALS | | | | |
|---|---------------------|--|---------------------|--|
| SAFETY APPROVALS X2 | VOLTAGE | VALUE | FILE NUMBERS | LINK |
| EN 60384-14 (ENEC) (= IEC 60384-14 ed-3) | 310 V _{AC} | 0.01 μF to 2.2 μF X2 | 40005079 | www.vishay.com/doc?28196 |
| UL 60384-14 | 310 V _{AC} | 0.01 μF to 2.2 μF X2 | E354331 | www.vishay.com/doc?28191 |
| CSA-E 384-14 | 310 V _{AC} | 0.01 μF to 2.2 μF X2 | E354331 | |
| CB test-certificate | 310 V _{AC} | 0.01 μF to 2.2 μF X2 | DE 1-40110/A1 | www.vishay.com/doc?28195 |
| The ENEC-approval together with the CB-certificate replace all national marks of the following countries (they have already signed the ENEC-agreement): Austria; Belgium; Czech. Republic; Denmark; Finland; France; Germany; Greece; Hungary; Ireland; Italy; Luxembourg; Netherlands; Norway; Portugal; Slovenian; Spain; Sweden; Switzerland and United Kingdom. | | | | |
|  | |  | | |

MOUNTING

Normal Use

The capacitors are designed for mounting on printed-circuit boards. The capacitors packed in bandoliers are designed for mounting in printed-circuit boards by means of automatic insertion machines.

For detailed tape specifications refer to packaging information: www.vishay.com/doc?28139.

Specific Method of Mounting to Withstand Vibration and Shock

In order to withstand vibration and shock tests, it must be ensured that stand-off pips are in good contact with the printed-circuit board:

- For pitches ≤ 15 mm capacitors shall be mechanically fixed by the leads
- For larger pitches the capacitors shall be mounted in the same way and the body clamped

Space Requirements on Printed Circuit Board

The maximum space for length ($l_{max.}$), width ($w_{max.}$) and height ($h_{max.}$) of film capacitors to take in account on the printed circuit board is shown in the drawings.

- For products with pitch ≤ 15 mm, $\Delta w = \Delta l = 0.3$ mm; $\Delta h = 0.1$ mm
- For products with 15 mm $<$ pitch ≤ 27.5 mm, $\Delta w = \Delta l = 0.5$ mm; $\Delta h = 0.1$ mm
- For products with pitch = 37.5 mm, $\Delta w = \Delta l = 0.7$ mm; $\Delta h = 0.5$ mm

Eccentricity defined as in drawing. The maximum eccentricity is smaller than or equal to the lead diameter of the product concerned.

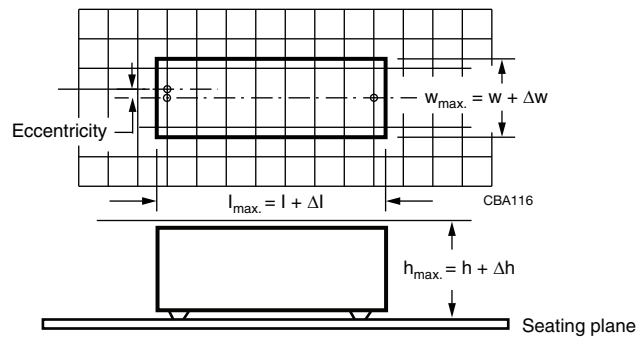

SOLDERING CONDITIONS

For general soldering conditions and wave soldering profile, we refer to the application note: "Soldering Guidelines for Film Capacitors": www.vishay.com/doc?28171

Storage Temperature

$T_{stg} = -25$ °C to $+35$ °C with RH maximum 75 % without condensation

Ratings and Characteristics Reference Conditions

Unless otherwise specified, all electrical values apply to an ambient temperature of 23 °C ± 1 °C, an atmospheric pressure of 86 kPa to 106 kPa and a relative humidity of 50 % ± 2 %.

For reference testing, a conditioning period shall be applied over 96 h ± 4 h by heating the products in a circulating air oven at the rated temperature and a relative humidity not exceeding 20 %.

CHARACTERISTICS

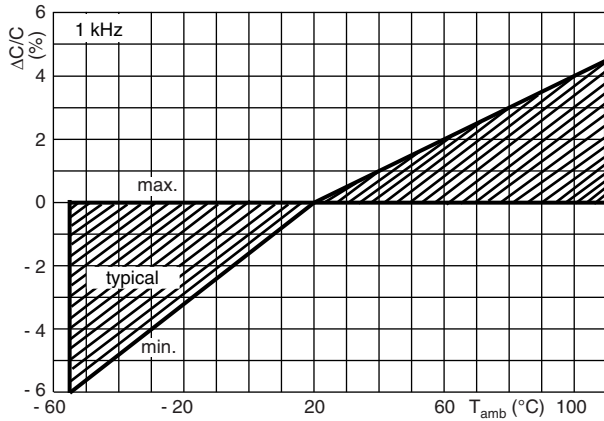

Capacitance as a function of ambient temperature (typical curve)

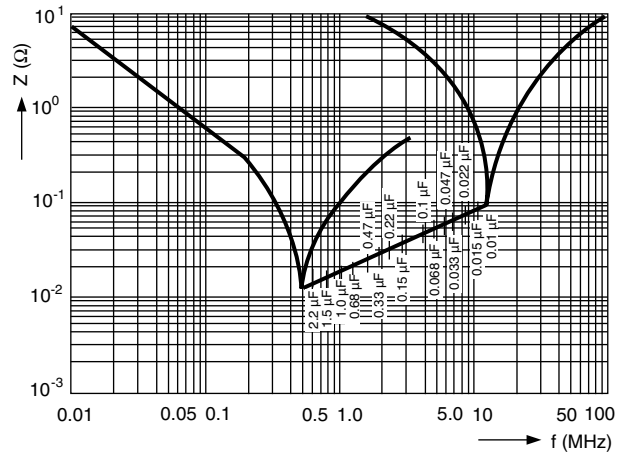

Impedance as a function of frequency (typical curve)

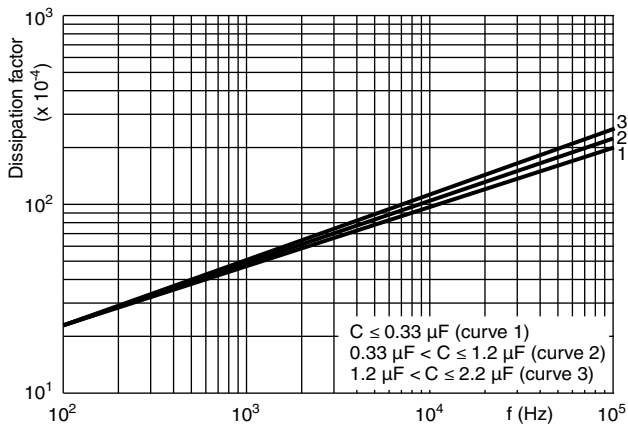

Tangent of loss angle as a function of frequency (typical curve)

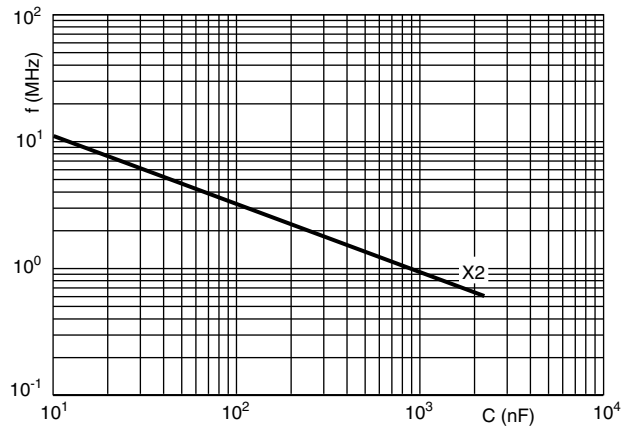

Resonant frequency as a function of capacitance (typical curve)

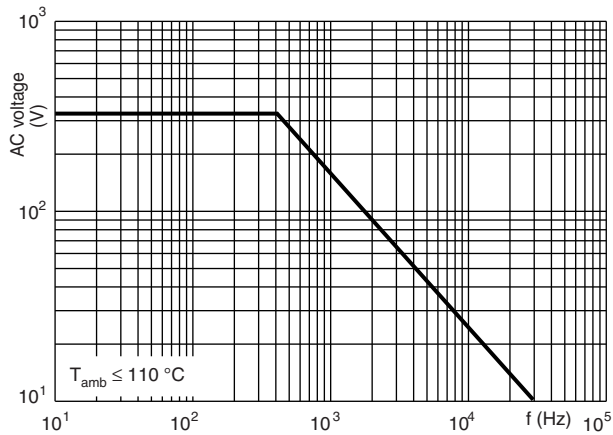

Max. RMS voltage as a function of frequency

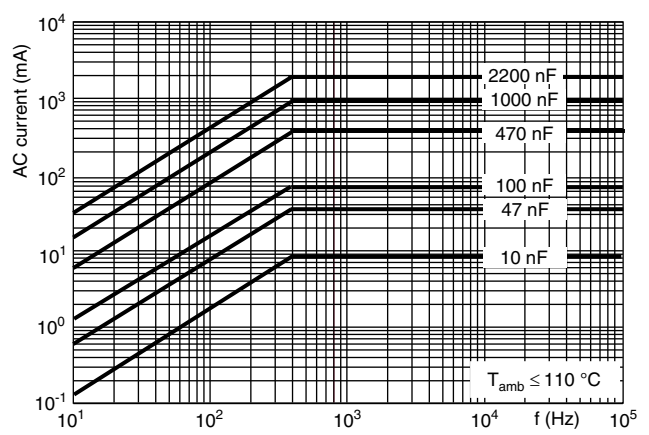

Max. RMS current as a function of frequency

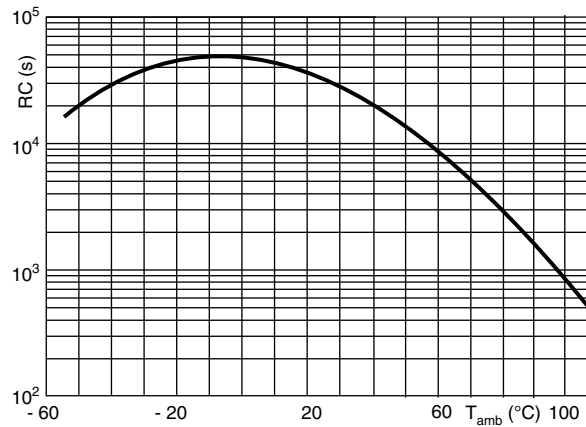

Insulation resistance as a function of ambient temperature (typical curve)

APPLICATION NOTES AND LIMITING CONDITIONS

- For X2 electromagnetic interference suppression where a higher stability grade is needed for **continuous across the line applications** (50 Hz/60 Hz) with a maximum mains voltage of 310 V_{AC}.
- These capacitors are not intended for continuous pulse application. For these situations capacitors of the AC and pulse programs must be used.
- For series impedance applications we refer to application note: www.vishay.com/doc?28153
- The maximum ambient temperature must not exceed 110 °C.
- Rated voltage pulse slope:
If the pulse voltage is lower than the rated voltage, the values of the specific reference data can be multiplied by 435 V_{DC} and divided by the applied voltage.

INSPECTION REQUIREMENTS

General Notes

Sub-clause numbers of tests and performance requirements refer to the “Sectional Specification, Publication IEC 60384-14 ed 3 and Specific Reference Data”.

| GROUP C INSPECTION REQUIREMENTS | | |
|---|--|--|
| SUB-CLAUSE NUMBER AND TEST | CONDITIONS | PERFORMANCE REQUIREMENTS |
| SUB-GROUP C1A PART OF SAMPLE OF SUB-GROUP C1 | | |
| 4.1 Dimensions (detail) | | As specified in chapter “General Data” of this specification |
| Initial measurements | Capacitance Tangent of loss angle: For C ≤ 1 μF at 10 kHz For C > 1 μF at 1 kHz | |
| 4.3 Robustness of terminations | Tensile: Load 10 N; 10 s Bending: Load 5 N; 4 x 90° | No visible damage |
| 4.4 Resistance to soldering heat | No pre-drying Method: 1A Solder bath: 280 °C ± 5 °C Duration: 10 s | |



| GROUP C INSPECTION REQUIREMENTS | | |
|---|---|--|
| SUB-CLAUSE NUMBER AND TEST | CONDITIONS | PERFORMANCE REQUIREMENTS |
| SUB-GROUP C1A PART OF SAMPLE OF SUB-GROUP C1 | | |
| 4.19 Component solvent resistance | Isopropylalcohol at room temperature Method: 2 Immersion time: 5 min ± 0.5 min Recovery time: Min. 1 h, max. 2 h | |
| 4.4.2 Final measurements | Visual examination Capacitance Tangent of loss angle Insulation resistance | No visible damage Legible marking $ \Delta C/C \leq 5\%$ of the value measured initially Increase of $\tan \delta$ ≤ 0.008 for: $C \leq 1 \mu F$ or ≤ 0.005 for: $C > 1 \mu F$ Compared to values measured initially As specified in section "Insulation Resistance" of this specification |
| SUB-GROUP C1B PART OF SAMPLE OF SUB-GROUP C1 | | |
| Initial measurements | Capacitance Tangent of loss angle: For $C \leq 1 \mu F$ at 10 kHz For $C > 1 \mu F$ at 1 kHz | |
| 4.20 Solvent resistance of the marking | Isopropylalcohol at room temperature Method: 1 Rubbing material: Cotton wool Immersion time: 5 min ± 0.5 min | No visible damage Legible marking |
| 4.6 Rapid change of temperature | $\theta A = -40\text{ }^\circ C$ $\theta B = +110\text{ }^\circ C$ 5 cycles Duration $t = 30$ min | |
| 4.6.1 Inspection | Visual examination | No visible damage |
| 4.7 Vibration | Mounting: See section "Mounting" of this specification Procedure B4 Frequency range: 10 Hz to 55 Hz Amplitude: 0.75 mm or Acceleration 98 m/s^2 (whichever is less severe) Total duration 6 h | |
| 4.7.2 Final inspection | Visual examination | No visible damage |
| 4.9 Shock | Mounting: See section "Mounting" for more information Pulse shape: Half sine Acceleration: 490 m/s^2 Duration of pulse: 11 ms | |
| 4.9.2 Final measurements | Visual examination Capacitance Tangent of loss angle Insulation resistance | No visible damage $ \Delta C/C \leq 5\%$ of the value measured initially Increase of $\tan \delta$ ≤ 0.008 for: $C \leq 1 \mu F$ or ≤ 0.005 for: $C > 1 \mu F$ Compared to values measured initially As specified in section "Specific Reference" of this specification |



| GROUP C INSPECTION REQUIREMENTS | | |
|--|---|--|
| SUB-CLAUSE NUMBER AND TEST | CONDITIONS | PERFORMANCE REQUIREMENTS |
| SUB-GROUP C1 COMBINED SAMPLE OF SPECIMENS OF SUB-GROUPS C1A AND C1B | | |
| 4.11 Climatic sequence | Capacitance | |
| 4.11.1 Initial measurements | Measured in 4.4.2 and 4.9.2 Tangent of loss angle Measured initially in C1A and C1B | |
| 4.11.2 Dry heat | Temperature: 110 °C Duration: 16 h | |
| 4.11.3 Damp heat cyclic Test Db, first cycle | | |
| 4.11.4 Cold | Temperature: -40 °C Duration: 2 h | |
| 4.11.5 Damp heat cyclic Test Db, remaining cycles | | |
| 4.11.6 Final measurements | Visual examination | No visible damage Legible marking |
| | Capacitance | $ \Delta C/C \leq 5\%$ of the value measured in 4.11.1 |
| | Tangent of loss angle | Increase of $\tan \delta$ ≤ 0.008 for: $C \leq 1 \mu\text{F}$ or ≤ 0.005 for: $C > 1 \mu\text{F}$ Compared to values measured in 4.11.1 |
| | Voltage proof 1350 V _{DC} 1 min between terminations | No permanent breakdown or flash-over |
| | Insulation resistance | $\geq 50\%$ of values specified in section "Insulation Resistance" of this specification |
| SUB-GROUP C2 | | |
| 4.12 Damp heat steady state | 56 days, 40 °C, 90 % to 95 % RH No load | |
| 4.12.1 Initial measurements | Capacitance Tangent of loss angle: 1 kHz | |
| 4.12.3 Final measurements | Visual examination | No visible damage Legible marking |
| | Capacitance | $ \Delta C/C \leq 5\%$ of the value measured in 4.12.1 |
| | Tangent of loss angle | Increase of $\tan \delta$ ≤ 0.008 for: $C \leq 1 \mu\text{F}$ or ≤ 0.005 for: $C > 1 \mu\text{F}$ Compared to values measured in 4.12.1 |
| | Voltage proof 1350 V _{DC} ; 1 min between terminations | No permanent breakdown or flash-over |
| | Insulation resistance | $\geq 50\%$ of values specified in section "Insulation Resistance" of this specification |

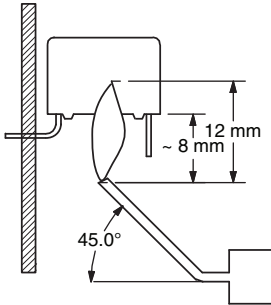

| GROUP C INSPECTION REQUIREMENTS | | |
|---------------------------------|---|--|
| SUB-CLAUSE NUMBER AND TEST | CONDITIONS | PERFORMANCE REQUIREMENTS |
| SUB-GROUP C3 | | |
| 4.13.1 Initial measurements | Capacitance Tangent of loss angle: For C ≤ 1 μF at 10 kHz For C > 1 μF at 1 kHz | |
| 4.13 Impulse voltage | 3 successive impulses, full wave, peak voltage: X2: 2.5 kV for C ≤ 1 μF X2: 2.5 kV/√C for C > 1 μF Max. 24 pulses | No self healing breakdowns or flash-over |
| 4.14 Endurance | Duration: 1000 h 1.25 x U _{RAC} at 110 °C Once in every hour the voltage is increased to 1000 V (RMS) for 0.1 s via resistor of 47 Ω ± 5 % | |
| 4.14.7 Final measurements | Visual examination Capacitance Tangent of loss angle Voltage proof 1350 V _{DC} ; 1 min between terminations 2120 V _{AC} ; 1 min between terminations and case Insulation resistance | No visible damage Legible marking ΔC/C ≤ 5 % compared to values measured in 4.13.1 Increase of tan δ ≤ 0.008 for: C ≤ 1 μF or ≤ 0.005 for: C > 1 μF Compared to values measured in 4.13.1 No permanent breakdown or flash-over ≥ 50 % of values specified in section "Insulation Resistance" of this specification |
| SUB-GROUP C4 | | |
| 4.15 Charge and discharge | 10 000 cycles Charged to 435 V _{DC} Discharge resistance: $R = \frac{435 V_{DC}}{1.5 \times C(dU/dt)}$ | |
| 4.15.1 Initial measurements | Capacitance Tangent of loss angle: For C ≤ 1 μF at 10 kHz For C > 1 μF at 1 kHz | |
| 4.13.3 Final measurements | Capacitance Tangent of loss angle Insulation resistance | ΔC/C ≤ 10 % compared to values measured in 4.15.1 Increase of tan δ ≤ 0.008 for: C ≤ 1 μF or ≤ 0.005 for: C > 1 μF Compared to values measured in 4.15.1 ≥ 50 % of values specified in section "Insulation Resistance" of this specification |

| GROUP C INSPECTION REQUIREMENTS | | |
|--|--|--|
| SUB-CLAUSE NUMBER AND TEST | CONDITIONS | PERFORMANCE REQUIREMENTS |
| SUB-GROUP C5 | | |
| 4.16 Radio frequency characteristic | Resonance frequency | ≥ 0.9 times the value as specified in section "Resonant Frequency" of this specification. |
| SUB-GROUP C6 | | |
| 4.17 Passive flammability Class C | Bore of gas jet: $\varnothing 0.5$ mm Fuel: Butane Test duration for actual volume V in mm ³ : $V \leq 250$: 5 s $250 < V \leq 500$: 10 s $500 < V \leq 1750$: 20 s $V > 1750$: 30 s One flame application  | After removing test flame from capacitor, the capacitor must not continue to burn for more than 30 s. No burning particle must drop from the sample. |
| SUB-GROUP C7 | | |
| 4.18 Active flammability | 20 cycles of 2.5 kV discharges on the test capacitor connected to U_{RAC} . | The cheese cloth around the capacitors shall not burn with a flame. No electrical measurements are required. |



Disclaimer

ALL PRODUCT, PRODUCT SPECIFICATIONS AND DATA ARE SUBJECT TO CHANGE WITHOUT NOTICE TO IMPROVE RELIABILITY, FUNCTION OR DESIGN OR OTHERWISE.

Vishay Intertechnology, Inc., its affiliates, agents, and employees, and all persons acting on its or their behalf (collectively, "Vishay"), disclaim any and all liability for any errors, inaccuracies or incompleteness contained in any datasheet or in any other disclosure relating to any product.

Vishay makes no warranty, representation or guarantee regarding the suitability of the products for any particular purpose or the continuing production of any product. To the maximum extent permitted by applicable law, Vishay disclaims (i) any and all liability arising out of the application or use of any product, (ii) any and all liability, including without limitation special, consequential or incidental damages, and (iii) any and all implied warranties, including warranties of fitness for particular purpose, non-infringement and merchantability.

Statements regarding the suitability of products for certain types of applications are based on Vishay's knowledge of typical requirements that are often placed on Vishay products in generic applications. Such statements are not binding statements about the suitability of products for a particular application. It is the customer's responsibility to validate that a particular product with the properties described in the product specification is suitable for use in a particular application. Parameters provided in datasheets and/or specifications may vary in different applications and performance may vary over time. All operating parameters, including typical parameters, must be validated for each customer application by the customer's technical experts. Product specifications do not expand or otherwise modify Vishay's terms and conditions of purchase, including but not limited to the warranty expressed therein.

Except as expressly indicated in writing, Vishay products are not designed for use in medical, life-saving, or life-sustaining applications or for any other application in which the failure of the Vishay product could result in personal injury or death. Customers using or selling Vishay products not expressly indicated for use in such applications do so at their own risk. Please contact authorized Vishay personnel to obtain written terms and conditions regarding products designed for such applications.

No license, express or implied, by estoppel or otherwise, to any intellectual property rights is granted by this document or by any conduct of Vishay. Product names and markings noted herein may be trademarks of their respective owners.

Material Category Policy

Vishay Intertechnology, Inc. hereby certifies that all its products that are identified as RoHS-Compliant fulfill the definitions and restrictions defined under Directive 2011/65/EU of The European Parliament and of the Council of June 8, 2011 on the restriction of the use of certain hazardous substances in electrical and electronic equipment (EEE) - recast, unless otherwise specified as non-compliant.

Please note that some Vishay documentation may still make reference to RoHS Directive 2002/95/EC. We confirm that all the products identified as being compliant to Directive 2002/95/EC conform to Directive 2011/65/EU.

Vishay Intertechnology, Inc. hereby certifies that all its products that are identified as Halogen-Free follow Halogen-Free requirements as per JEDEC JS709A standards. Please note that some Vishay documentation may still make reference to the IEC 61249-2-21 definition. We confirm that all the products identified as being compliant to IEC 61249-2-21 conform to JEDEC JS709A standards.

Компания «Океан Электроники» предлагает заключение долгосрочных отношений при поставках импортных электронных компонентов на взаимовыгодных условиях!

Наши преимущества:

- Поставка оригинальных импортных электронных компонентов напрямую с производств Америки, Европы и Азии, а так же с крупнейших складов мира;
- Широкая линейка поставок активных и пассивных импортных электронных компонентов (более 30 млн. наименований);
- Поставка сложных, дефицитных, либо снятых с производства позиций;
- Оперативные сроки поставки под заказ (от 5 рабочих дней);
- Экспресс доставка в любую точку России;
- Помощь Конструкторского Отдела и консультации квалифицированных инженеров;
- Техническая поддержка проекта, помощь в подборе аналогов, поставка прототипов;
- Поставка электронных компонентов под контролем ВП;
- Система менеджмента качества сертифицирована по Международному стандарту ISO 9001;
- При необходимости вся продукция военного и аэрокосмического назначения проходит испытания и сертификацию в лаборатории (по согласованию с заказчиком);
- Поставка специализированных компонентов военного и аэрокосмического уровня качества (Xilinx, Altera, Analog Devices, Intersil, Interpoint, Microsemi, Actel, Aeroflex, Peregrine, VPT, Syfer, Eurofarad, Texas Instruments, MS Kennedy, Miteq, Cobham, E2V, MA-COM, Hittite, Mini-Circuits, General Dynamics и др.);

Компания «Океан Электроники» является официальным дистрибьютором и эксклюзивным представителем в России одного из крупнейших производителей разъемов военного и аэрокосмического назначения «JONHON», а так же официальным дистрибьютором и эксклюзивным представителем в России производителя высокотехнологичных и надежных решений для передачи СВЧ сигналов «FORSTAR».



JONHON

«JONHON» (основан в 1970 г.)

Разъемы специального, военного и аэрокосмического назначения:

(Применяются в военной, авиационной, аэрокосмической, морской, железнодорожной, горно- и нефтедобывающей отраслях промышленности)

«FORSTAR» (основан в 1998 г.)

ВЧ соединители, коаксиальные кабели, кабельные сборки и микроволновые компоненты:

(Применяются в телекоммуникациях гражданского и специального назначения, в средствах связи, РЛС, а так же военной, авиационной и аэрокосмической отраслях промышленности).



Телефон: 8 (812) 309-75-97 (многоканальный)

Факс: 8 (812) 320-03-32

Электронная почта: ocean@oceanchips.ru

Web: <http://oceanchips.ru/>

Адрес: 198099, г. Санкт-Петербург, ул. Калинина, д. 2, корп. 4, лит. А