



GaAs MMIC I/Q DOWNCONVERTER 17 - 24 GHz

Typical Applications

The HMC904LC5 is ideal for:

- Point-to-Point and Point-to-Multi-Point Radio
- Military Radar, EW & ELINT
- Satellite Communications

Features

- Conversion Gain: 12 dB
- Image Rejection: 30 dB
- 2 LO to RF Isolation: 45 dB
- Noise Figure: 3 dB
- Input IP3: 0 dBm
- 32 Lead 5x5mm SMT Package: 25mm²

Functional Diagram

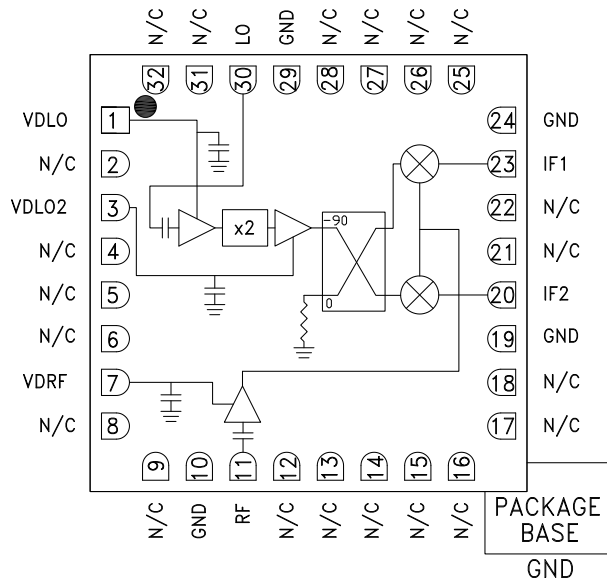

General Description

The HMC904LC5 is a compact GaAs MMIC I/Q downconverter in a leadless RoHS compliant SMT package. This device provides a small signal conversion gain of 12 dB with a noise figure of 3 dB and 30 dB of image rejection across the frequency band. The HMC904LC5 utilizes an LNA followed by an image reject mixer which is driven by an active x2 multiplier. The image reject mixer eliminates the need for a filter following the LNA, and removes thermal noise at the image frequency. I and Q mixer outputs are provided and an external 90° hybrid is needed to select the required sideband. The HMC904LC5 is a much smaller alternative to hybrid style image reject mixer downconverter assemblies, and is compatible with surface mount manufacturing techniques.

Electrical Specifications, $T_A = +25\text{ }^\circ\text{C}$, IF = 1000 MHz, LO = +4 dBm, Vdd = 3.5 Vdc USB [1]

Parameter	Min.	Typ.	Max.	Min.	Typ.	Max.	Units
Frequency Range, RF		17 - 20		20 - 24			GHz
Frequency Range, LO		7.5 - 11.75		8.25 - 12.3			GHz
Frequency Range, IF		DC - 3.5		DC - 3.5			GHz
Conversion Gain (As IRM)	8.5	12		8.5	12		dB
Noise Figure		3			3		dB
Image Rejection	20	35		15	30		dB
1 dB Compression (Input)		-8			-6		dBm
2 LO to RF Isolation	40	45		32	40		dB
2 LO to IF Isolation	10	15		15	20		dB
IP3 (Input)		0			0		dBm
Amplitude Balance [2]		0.25			0.25		dB
Phase Balance [2]		7			7		deg
Total Supply Current		160	190		160	190	mA

[1] Data taken as IRM with external IF 90° Hybrid

[2] Data taken without external 90° hybrid, IF = 500 MHz



**GaAs MMIC I/Q DOWNCONVERTER
17 - 24 GHz**

Data Taken As IRM With External IF 90° Hybrid, IF = 1000 MHz

Conversion Gain USB vs. Temperature

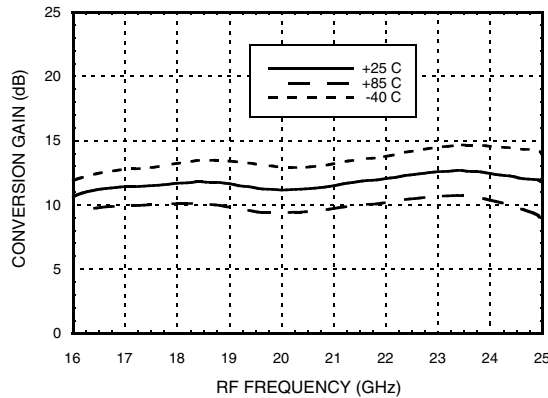

Conversion Gain USB vs. LO Drive

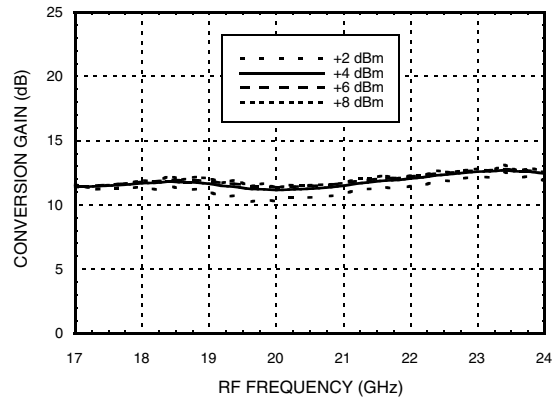
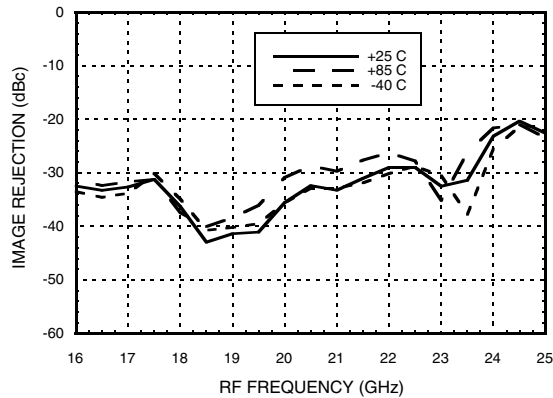
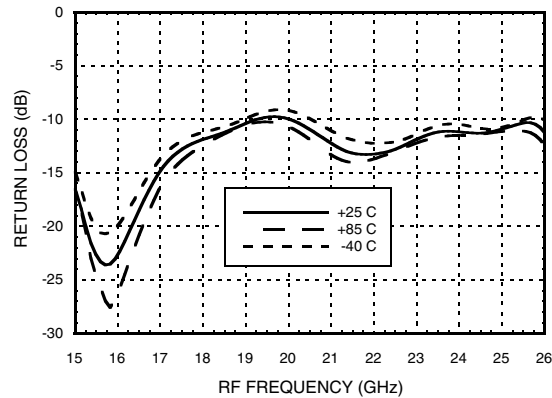

Image Rejection vs. Temperature



RF Return Loss vs. Temperature



LO Return Loss vs. Temperature

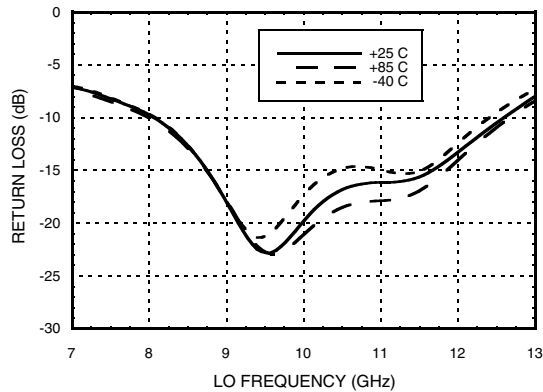

IF Return Loss [1]

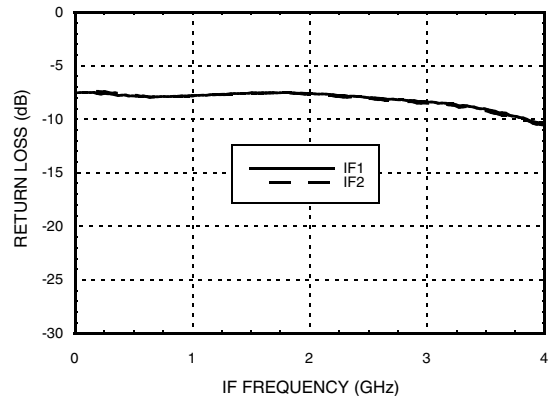

[1] Data taken without external 90° hybrid.



**GaAs MMIC I/Q DOWNCONVERTER
17 - 24 GHz**

Data Taken as IRM With External IF 90° Hybrid, IF = 1000 MHz

Isolations

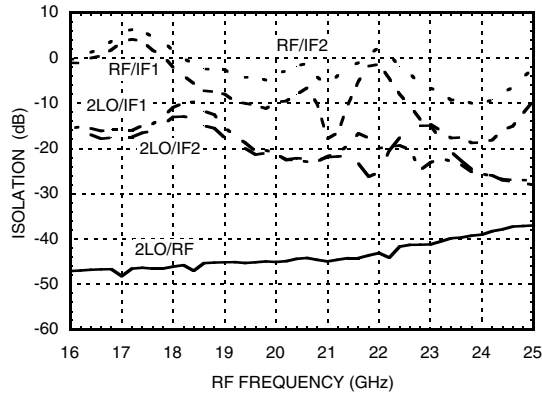

Input P1dB USB vs. Temperature

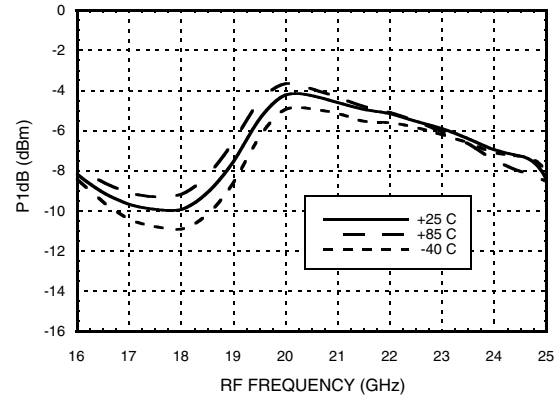

Input IP3, USB vs. Temperature

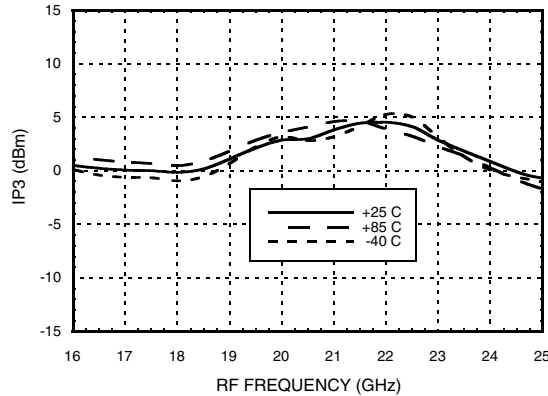

Input IP3, USB vs. LO Drive

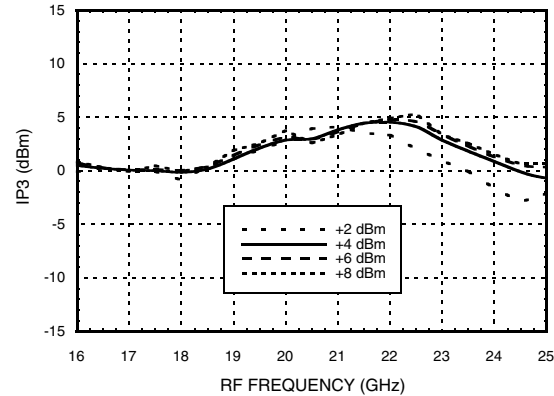

**Noise Figure vs. LO Drive,
LO Frequency = 9 GHz**

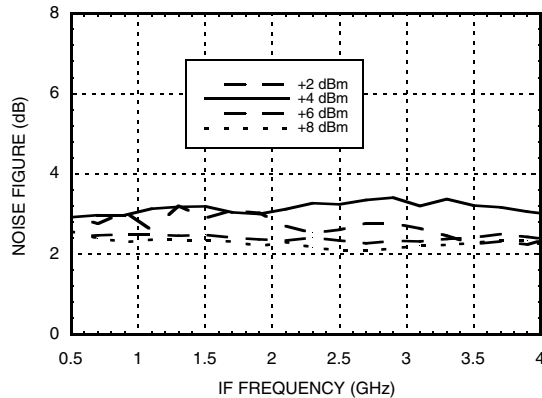

**Noise Figure vs. Temperature,
IF Frequency = 1000 MHz**

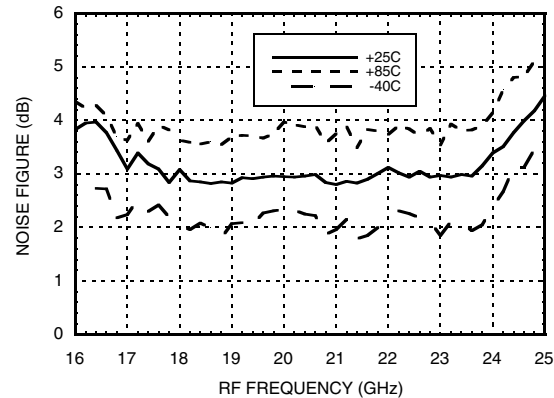

* Conversion gain data taken with external IF 90° IF hybrid, LO frequency fixed at 8.5 GHz and RF varied

Information furnished by Analog Devices is believed to be accurate and reliable. However, no responsibility is assumed by Analog Devices for its use, nor for any infringements of patents or other rights of third parties that may result from its use. Specifications subject to change without notice. No license is granted by implication or otherwise under any patent or patent rights of Analog Devices. Trademarks and registered trademarks are the property of their respective owners.

For price, delivery, and to place orders: Analog Devices, Inc., One Technology Way, P.O. Box 9106, Norwood, MA 02062-9106 Phone: 781-329-4700 • Order online at www.analog.com Application Support: Phone: 1-800-ANALOG-D



**GaAs MMIC I/Q DOWNCONVERTER
17 - 24 GHz**

Quadrature Channel Data Taken Without IF 90° Hybrid, IF = 1000 MHz

IF Bandwidth

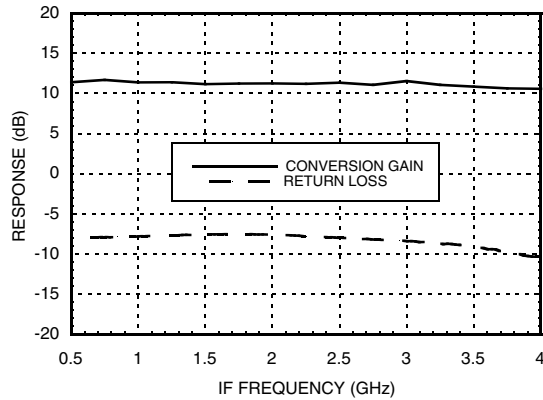

Amplitude Balance vs. LO Drive [1]

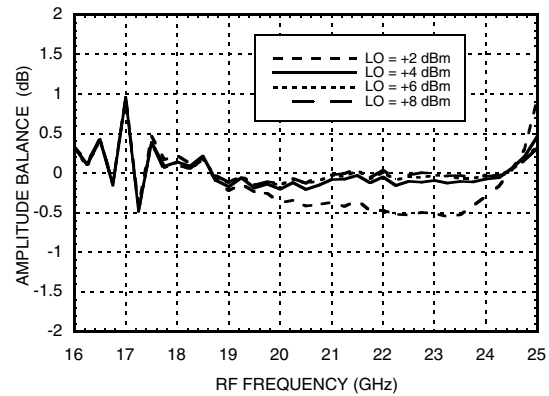

Phase Balance vs. LO Drive [1]

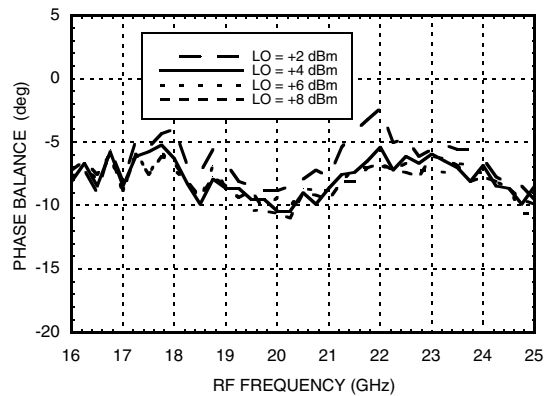

[1] Data taken with IF = 500 MHz



**GaAs MMIC I/Q DOWNCONVERTER
17 - 24 GHz**

Data Taken as IRM With External IF 90° Hybrid, IF = 1000 MHz

Conversion Gain, LSB vs. Temperature

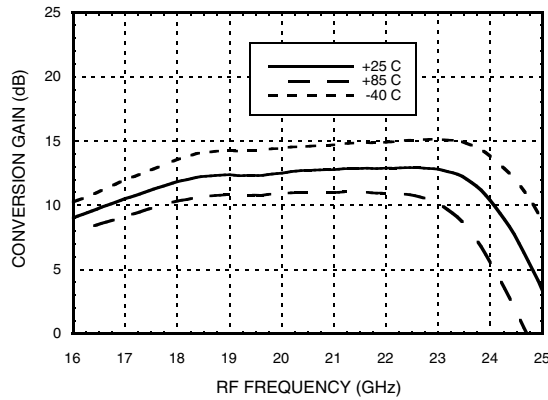

Conversion Gain, LSB vs. LO Drive

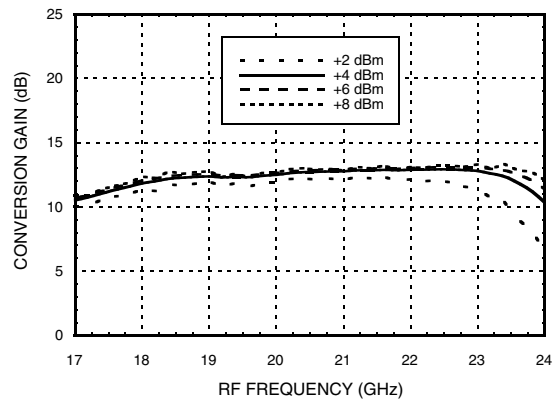
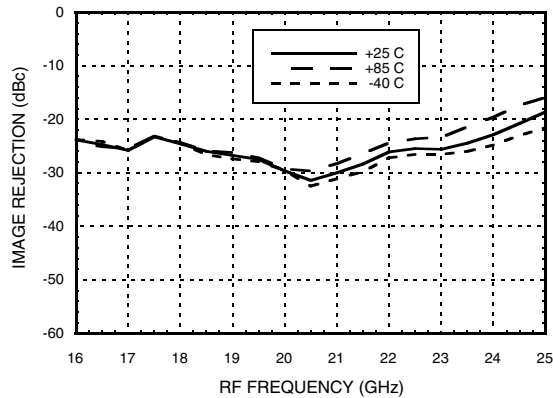
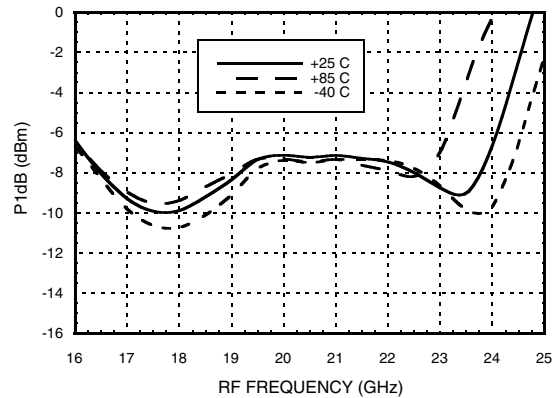

Image Rejection vs. Temperature



Input P1dB, LSB vs. Temperature



Input IP3, LSB vs. Temperature

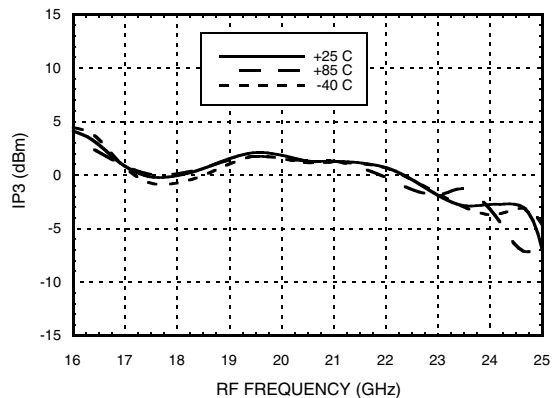

Input IP3, LSB vs. LO Drive

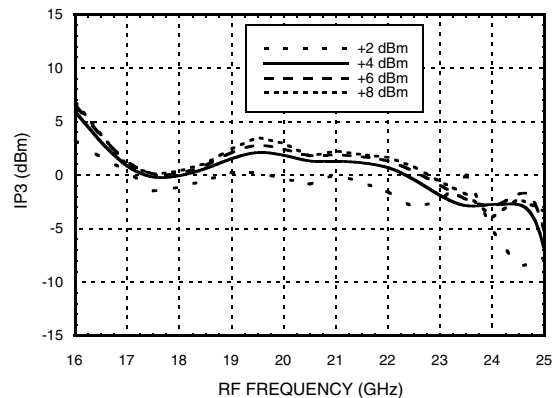

* Conversion gain data taken with external IF 90° IF hybrid, LO frequency fixed at 8.5 GHz and RF varied

Information furnished by Analog Devices is believed to be accurate and reliable. However, no responsibility is assumed by Analog Devices for its use, nor for any infringements of patents or other rights of third parties that may result from its use. Specifications subject to change without notice. No license is granted by implication or otherwise under any patent or patent rights of Analog Devices. Trademarks and registered trademarks are the property of their respective owners.

For price, delivery, and to place orders: Analog Devices, Inc., One Technology Way, P.O. Box 9106, Norwood, MA 02062-9106 Phone: 781-329-4700 • Order online at www.analog.com Application Support: Phone: 1-800-ANALOG-D



**GaAs MMIC I/Q DOWNCONVERTER
17 - 24 GHz**

Data Taken as IRM With External IF 90° Hybrid, IF = 2000 MHz

Conversion Gain, USB vs. Temperature

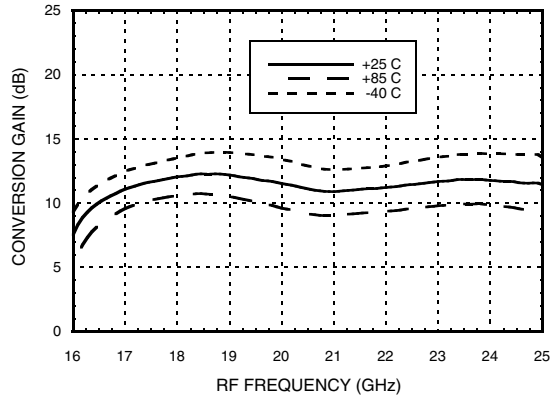

Conversion Gain, USB vs. LO Drive

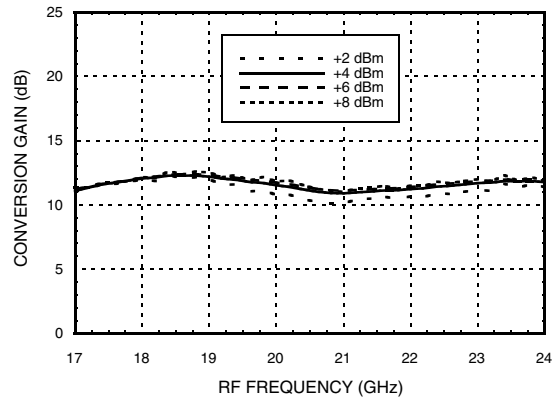
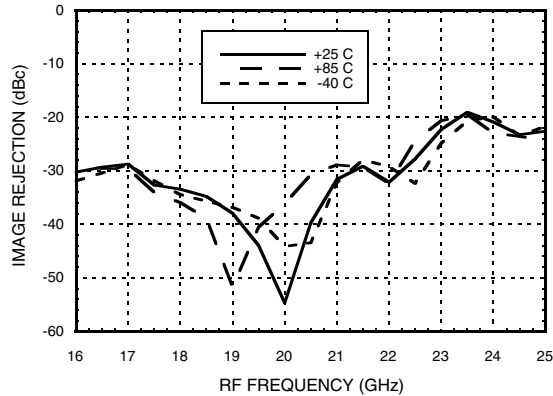
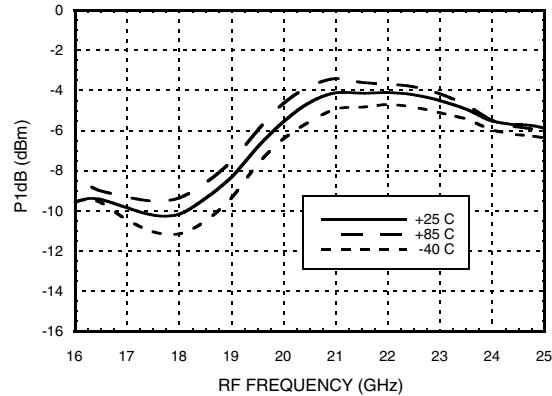

Image Rejection vs. Temperature



Input P1dB, USB vs. Temperature



Input IP3, USB vs. Temperature

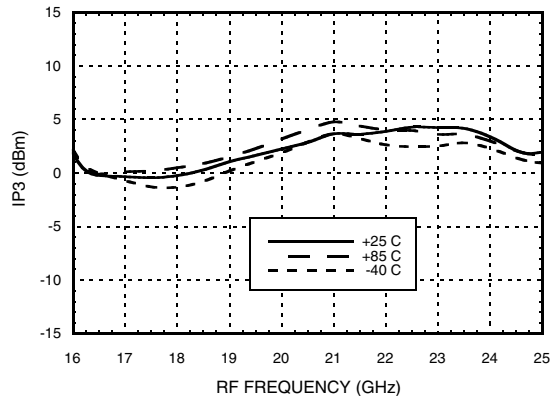

Input IP3, USB vs. LO Drive

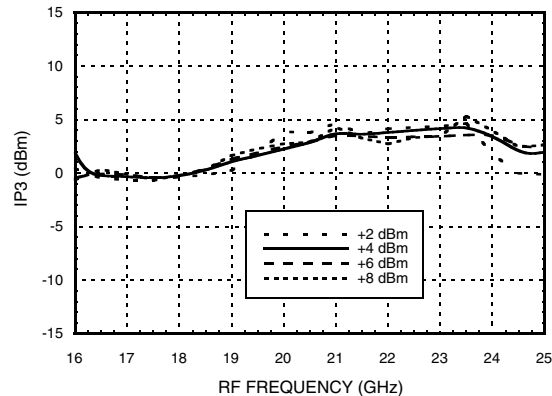

* Conversion gain data taken with external IF 90° IF hybrid, LO frequency fixed at 8.5 GHz and RF varied

Information furnished by Analog Devices is believed to be accurate and reliable. However, no responsibility is assumed by Analog Devices for its use, nor for any infringements of patents or other rights of third parties that may result from its use. Specifications subject to change without notice. No license is granted by implication or otherwise under any patent or patent rights of Analog Devices. Trademarks and registered trademarks are the property of their respective owners.

For price, delivery, and to place orders: Analog Devices, Inc., One Technology Way, P.O. Box 9106, Norwood, MA 02062-9106 Phone: 781-329-4700 • Order online at www.analog.com Application Support: Phone: 1-800-ANALOG-D



**GaAs MMIC I/Q DOWNCONVERTER
17 - 24 GHz**

Data Taken as IRM With External IF 90° Hybrid, IF = 2000 MHz

Conversion Gain, LSB vs. Temperature

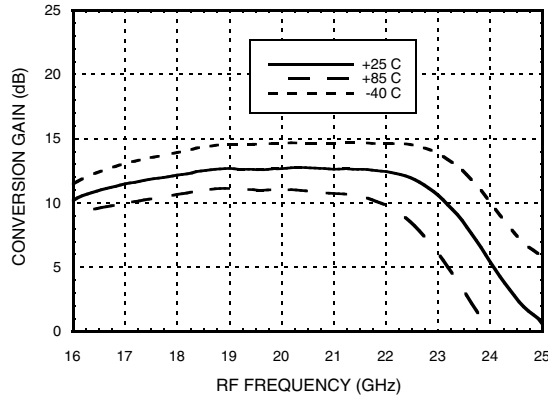

Conversion Gain, LSB vs. LO Drive

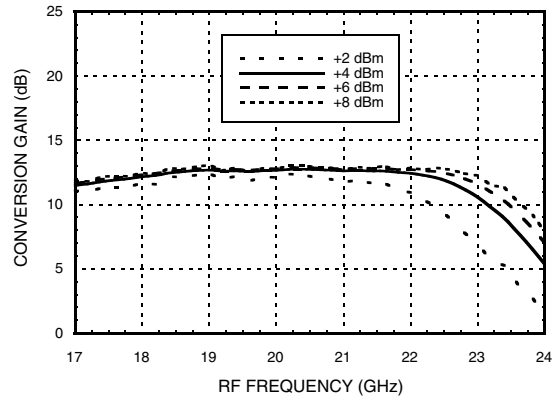
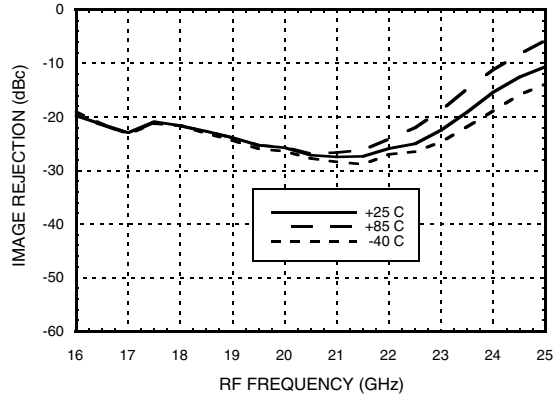
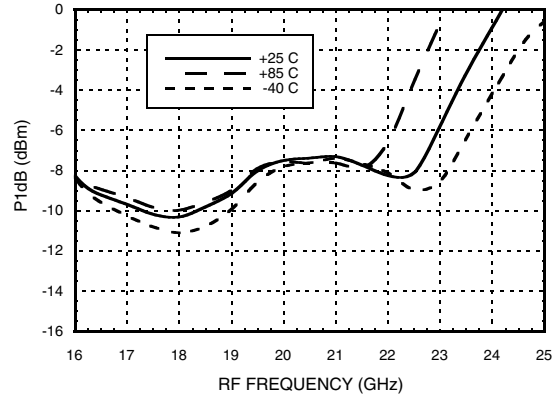

Image Rejection vs. Temperature



Input P1dB, LSB vs. Temperature



Input IP3, LSB vs. Temperature

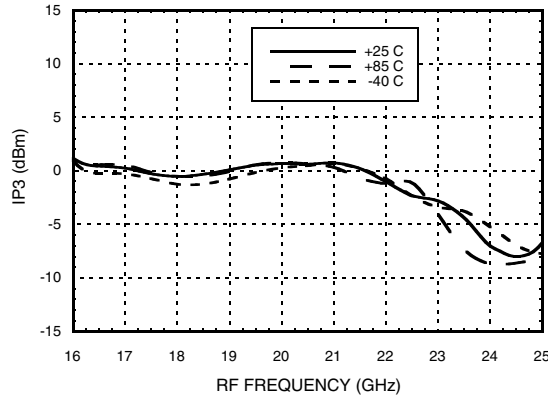

Input IP3, LSB vs. LO Drive

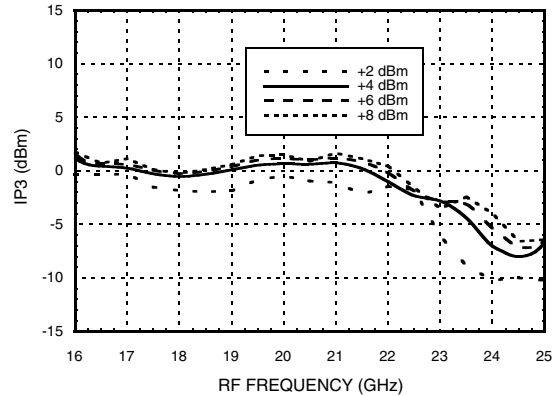

Information furnished by Analog Devices is believed to be accurate and reliable. However, no responsibility is assumed by Analog Devices for its use, nor for any infringements of patents or other rights of third parties that may result from its use. Specifications subject to change without notice. No license is granted by implication or otherwise under any patent or patent rights of Analog Devices. Trademarks and registered trademarks are the property of their respective owners.

For price, delivery, and to place orders: Analog Devices, Inc., One Technology Way, P.O. Box 9106, Norwood, MA 02062-9106 Phone: 781-329-4700 • Order online at www.analog.com Application Support: Phone: 1-800-ANALOG-D



**GaAs MMIC I/Q DOWNCONVERTER
17 - 24 GHz**

Data Taken as IRM With External IF 90° Hybrid, IF = 3350 MHz

Conversion Gain, USB vs. Temperature

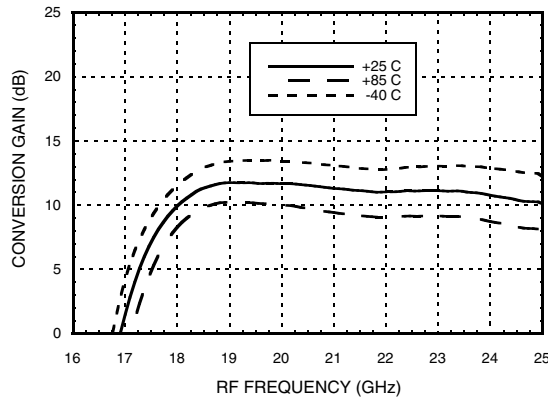

Conversion Gain, USB vs. LO Drive

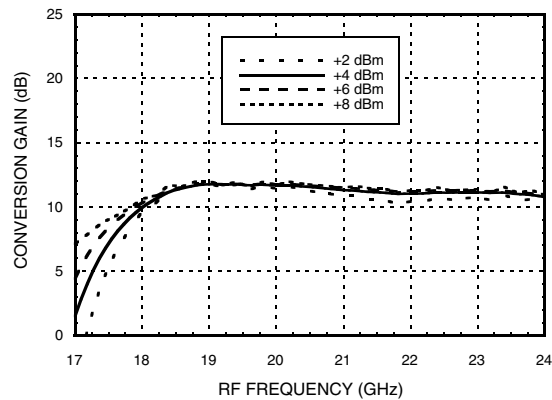
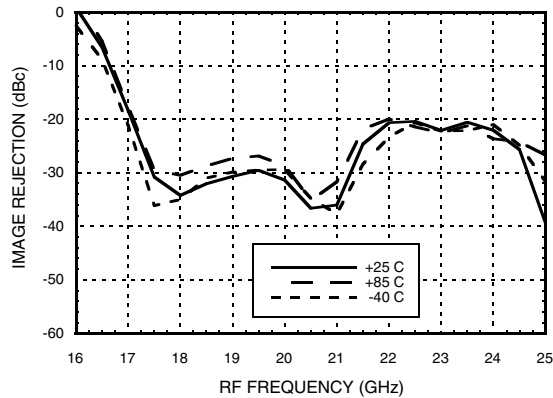
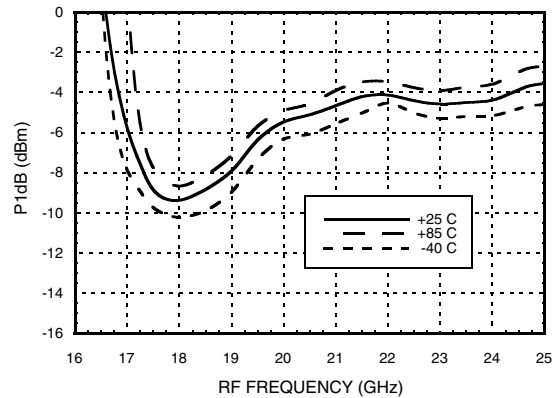

Image Rejection vs. Temperature



Input P1dB, USB vs. Temperature



Input IP3, USB vs. Temperature

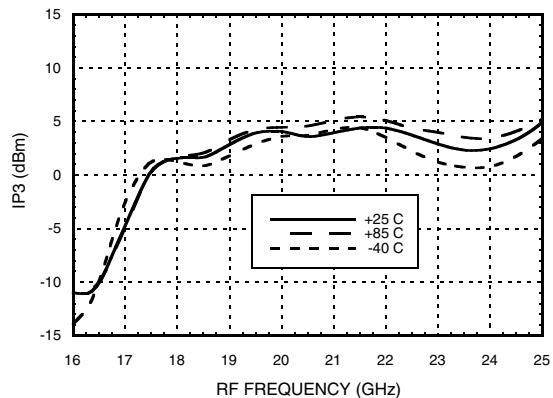

Input IP3, USB vs. LO Drive

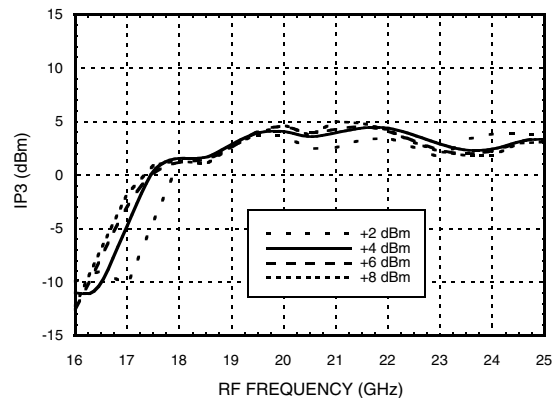

* Conversion gain data taken with external IF 90° IF hybrid, LO frequency fixed at 8.5 GHz and RF varied

Information furnished by Analog Devices is believed to be accurate and reliable. However, no responsibility is assumed by Analog Devices for its use, nor for any infringements of patents or other rights of third parties that may result from its use. Specifications subject to change without notice. No license is granted by implication or otherwise under any patent or patent rights of Analog Devices. Trademarks and registered trademarks are the property of their respective owners.

For price, delivery, and to place orders: Analog Devices, Inc., One Technology Way, P.O. Box 9106, Norwood, MA 02062-9106 Phone: 781-329-4700 • Order online at www.analog.com Application Support: Phone: 1-800-ANALOG-D



**GaAs MMIC I/Q DOWNCONVERTER
17 - 24 GHz**

Data Taken as IRM With External IF 90° Hybrid, IF = 3350 MHz

Conversion Gain, LSB vs. Temperature

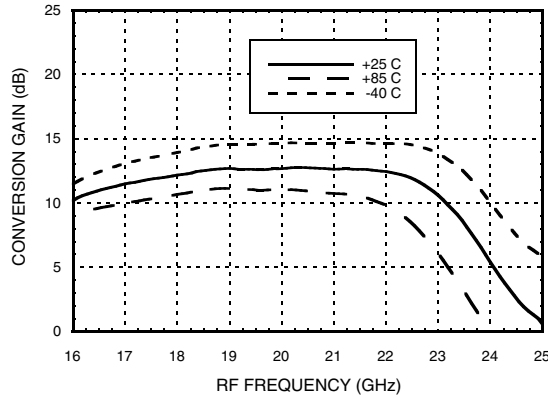

Conversion Gain, LSB vs. LO Drive

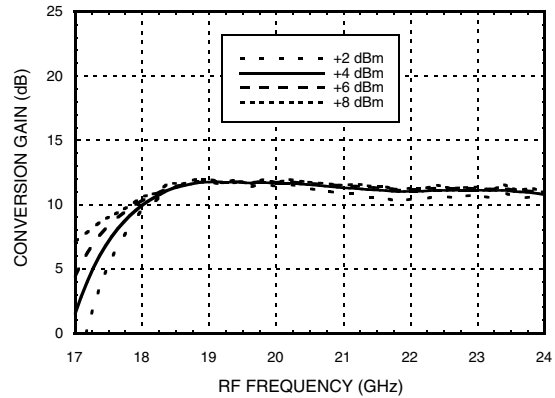
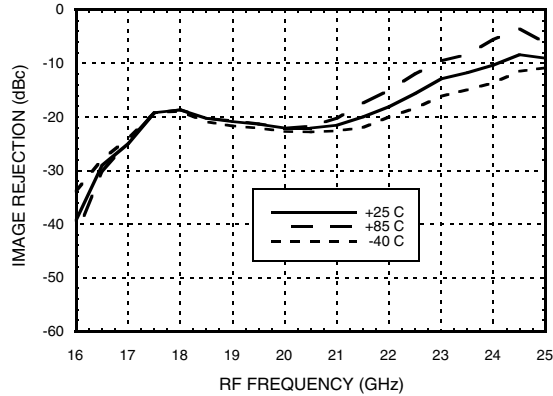
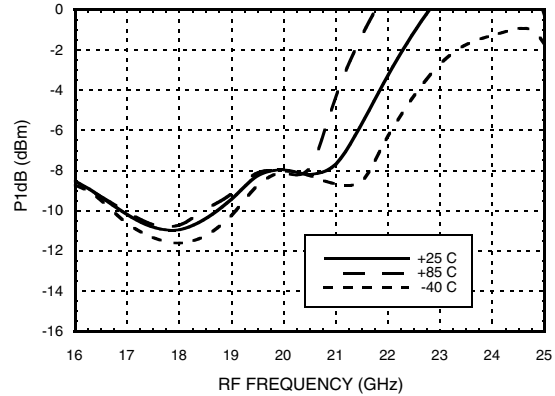

Image Rejection vs. Temperature



Input P1dB, LSB vs. Temperature



Input IP3, LSB vs. Temperature

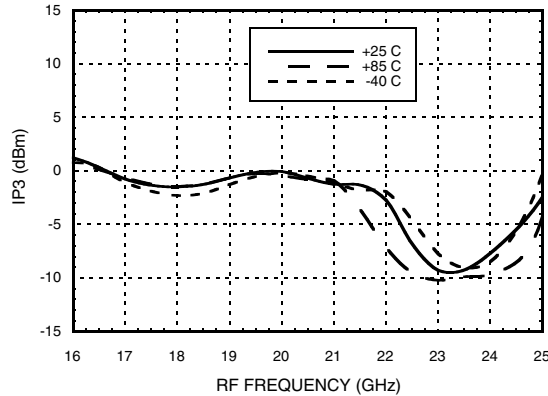

Input IP3, LSB vs. LO Drive

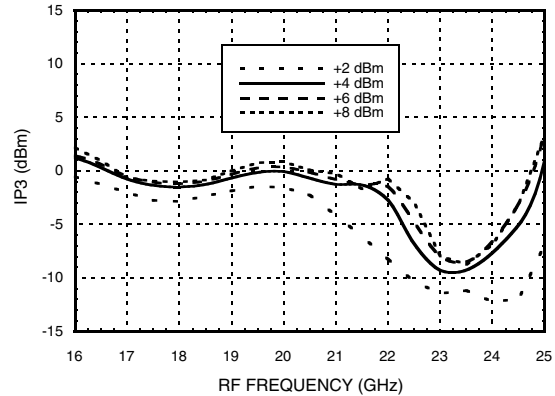

Information furnished by Analog Devices is believed to be accurate and reliable. However, no responsibility is assumed by Analog Devices for its use, nor for any infringements of patents or other rights of third parties that may result from its use. Specifications subject to change without notice. No license is granted by implication or otherwise under any patent or patent rights of Analog Devices. Trademarks and registered trademarks are the property of their respective owners.

For price, delivery, and to place orders: Analog Devices, Inc., One Technology Way, P.O. Box 9106, Norwood, MA 02062-9106 Phone: 781-329-4700 • Order online at www.analog.com Application Support: Phone: 1-800-ANALOG-D

**GaAs MMIC I/Q DOWNCONVERTER
17 - 24 GHz**
MxN Spurious Outputs

mRF	nLO				
	0	1	2	3	4
0	-	17	0	23	33
1	8	26	0	23	24
2	68	95	0	66	48
3	xx	xx	xx	xx	xx
4	xx	xx	xx	xx	xx

RF = 18 GHz @ -20 dBm

LO = 8.5 GHz @ +4 dBm

Data taken without IF hybrid

All values in dBc below IF power level (1RF -2LO = 1 GHz)

Absolute Maximum Ratings

RF	+2 dBm
LO Drive	+10 dBm
Vdd	5.5V
Channel Temperature	175 °C
Continuous P _{diss} (T=85°C) (derate 18.7 mW/°C above 85°C)	1.69 mW
Thermal Resistance (R _{TH}) (channel to package bottom)	53.2 °C/W
Storage Temperature	-65 to +150 °C
Operating Temperature	-55 to +85 °C
ESD Sensitivity (HBM)	Class 1B

**ELECTROSTATIC SENSITIVE DEVICE
OBSERVE HANDLING PRECAUTIONS**



Outline Drawing

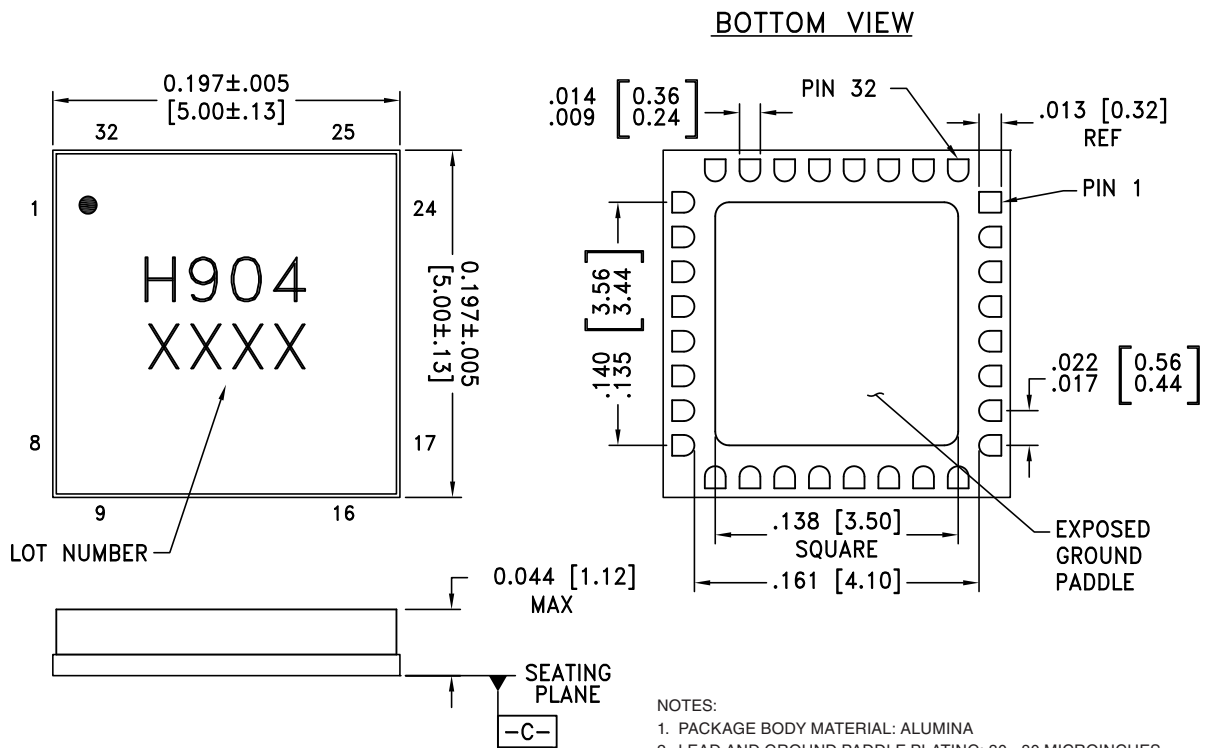

NOTES:

1. PACKAGE BODY MATERIAL: ALUMINA
2. LEAD AND GROUND PADDLE PLATING: 30 - 80 MICROINCHES GOLD OVER 50 MICROINCHES MINIMUM NICKLE
3. DIMENSIONS ARE IN INCHES [MILLIMETERS]
4. LEAD SPACING TOLERANCE IS NON-CUMULATIVE
5. PACKAGE WARP SHALL NOT EXCEED 0.05mm DATUM
6. ALL GROUND LEADS AND GROUND PADDLE MUST BE SOLDERED TO PCB RF GROUND

Package Information

Part Number	Package Body Material	Lead Finish	MSL Rating	Package Marking ^[2]
HMC904LC5	Alumina, White	Gold over Nickel	MSL3 ^[1]	H904 XXXX

[1] Max peak reflow temperature of 260 °C

[2] 4-Digit lot number XXXX



Pin Descriptions

Pin Number	Function	Description	Interface Schematic
1	VDLO	Power supply for first stage of LO amplifier.	
2, 4 - 6, 8, 9, 12 - 18, 21, 22, 25 - 28, 31, 32	N/C	The pins are not connected internally; however, all data shown herein was measured with these pins connected to RF/DC ground externally.	
3	VDLO2	Power supply for second stage of LO amplifier.	
7	VDRF	Power supply for RF LNA.	
10, 19, 24, 29	GND	These pins and the exposed ground paddle must be connected to RF/DC ground.	
11	RF	This pin is AC coupled and matched to 50 Ohms	
20	IF2	This pin is DC coupled. For applications not requiring operation to DC this port should be DC blocked externally using a series capacitor whose value has been chosen to pass the necessary frequency range. For operation to DC, this pin must not sink / source more than 3 mA of current or part non-function and possible failure will result.	
23	IF1		
30	LO	This pin is AC coupled and matched to 50 Ohms.	

Typical Application Circuit

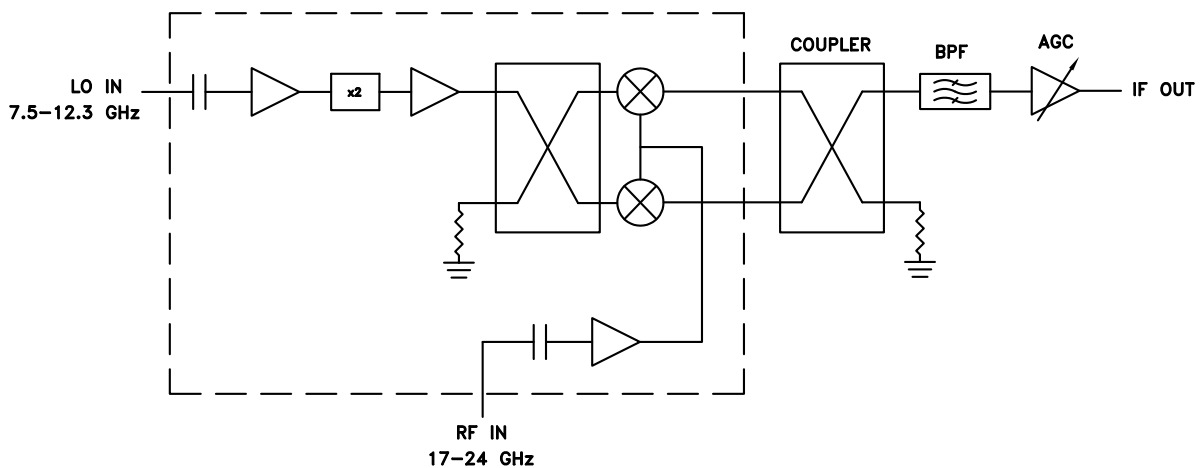



**GaAs MMIC I/Q DOWNCONVERTER
17 - 24 GHz**

Evaluation PCB

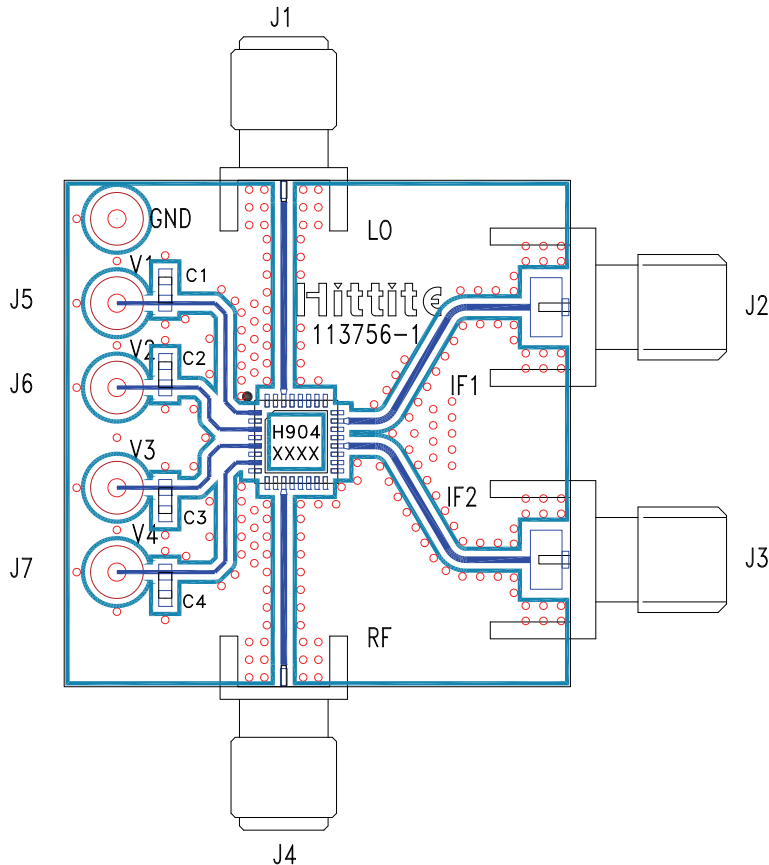

List of Materials for Evaluation PCB 113758 [1]

Item	Description
J1, J4	PCB Mount SMA RF Connector, SRI
J2, J3	PCB Mount SMA Connector, Johnson
J5 - J7	DC Pin
C1 - C4	0.01 μ F Capacitor, 0603 Pkg.
U1	HMC904LC5
PCB [2]	113756 Evaluation Board

[1] Reference this number when ordering complete evaluation PCB

[2] Circuit Board Material: Rogers 4350

The circuit board used in the application should use RF circuit design techniques. Signal lines should have 50 Ohm impedance while the package ground leads and exposed paddle should be connected directly to the ground plane similar to that shown. A sufficient number of via holes should be used to connect the top and bottom ground planes. The evaluation circuit board shown is available from Hittite upon request.

**GaAs MMIC I/Q DOWNCONVERTER
17 - 24 GHz**

Компания «Океан Электроники» предлагает заключение долгосрочных отношений при поставках импортных электронных компонентов на взаимовыгодных условиях!

Наши преимущества:

- Поставка оригинальных импортных электронных компонентов напрямую с производств Америки, Европы и Азии, а так же с крупнейших складов мира;
- Широкая линейка поставок активных и пассивных импортных электронных компонентов (более 30 млн. наименований);
- Поставка сложных, дефицитных, либо снятых с производства позиций;
- Оперативные сроки поставки под заказ (от 5 рабочих дней);
- Экспресс доставка в любую точку России;
- Помощь Конструкторского Отдела и консультации квалифицированных инженеров;
- Техническая поддержка проекта, помощь в подборе аналогов, поставка прототипов;
- Поставка электронных компонентов под контролем ВП;
- Система менеджмента качества сертифицирована по Международному стандарту ISO 9001;
- При необходимости вся продукция военного и аэрокосмического назначения проходит испытания и сертификацию в лаборатории (по согласованию с заказчиком);
- Поставка специализированных компонентов военного и аэрокосмического уровня качества (Xilinx, Altera, Analog Devices, Intersil, Interpoint, Microsemi, Actel, Aeroflex, Peregrine, VPT, Syfer, Eurofarad, Texas Instruments, MS Kennedy, Miteq, Cobham, E2V, MA-COM, Hittite, Mini-Circuits, General Dynamics и др.);

Компания «Океан Электроники» является официальным дистрибьютором и эксклюзивным представителем в России одного из крупнейших производителей разъемов военного и аэрокосмического назначения «JONHON», а так же официальным дистрибьютором и эксклюзивным представителем в России производителя высокотехнологичных и надежных решений для передачи СВЧ сигналов «FORSTAR».



JONHON

«JONHON» (основан в 1970 г.)

Разъемы специального, военного и аэрокосмического назначения:

(Применяются в военной, авиационной, аэрокосмической, морской, железнодорожной, горно- и нефтедобывающей отраслях промышленности)

«FORSTAR» (основан в 1998 г.)

ВЧ соединители, коаксиальные кабели, кабельные сборки и микроволновые компоненты:

(Применяются в телекоммуникациях гражданского и специального назначения, в средствах связи, РЛС, а так же военной, авиационной и аэрокосмической отраслях промышленности).



Телефон: 8 (812) 309-75-97 (многоканальный)

Факс: 8 (812) 320-03-32

Электронная почта: ocean@oceanchips.ru

Web: <http://oceanchips.ru/>

Адрес: 198099, г. Санкт-Петербург, ул. Калинина, д. 2, корп. 4, лит. А