

RTA Series

1-4 Poles Coded Rotary Switches



Features/Benefits

- PCB or hand soldering versions
- Bushing mounting
- Multiple poles
- Decimal and hexadecimal codes
- Screwdriver slot or extended actuator
- RoHS Compliant

Typical Applications

- Appliances
- Electronic alarm systems
- Medical
- Building automation
- HVAC air conditioning

Electrical Data

	Silver	Gold
SWITCHING MODE:	BBM	BBM
MAX. SWITCHING POWER	5 VA	0.5 VA
MAX. SWITCHING CURRENT:	150 mA	20 mA
MAX. CARRYING CURRENT:	5 A	1 A
NOMINAL VOLTAGE AT 50 Hz	60 V	25 V
CONTACT RESISTANCE:	< 150 mΩ	< 150 mΩ
DIELECTRIC STRENGTH AT 50 Hz BETWEEN CONTACTS AND GROUND TERMINALS:	500 V r	500 V r
INSULATION RESISTANCE BETWEEN CONTACTS OR CONTACTS AND FRAME (500 V ⇒):	10 ⁹ Ω	10 ⁹ Ω
NO. OF OPERATIONS:	10,000	10,000
BOUNCE:	< 5 ms	< 5 ms

Mechanical Data

MAX. NO. OF BANKS: 1.
 OPERATING TORQUE: 5 Ncm±20%.
 END STOP TORQUE: 50 Ncm. minimum
 STOP: With/without or adjustable
 MOUNTING: By fixed index 9.5 mm (0.374) of center, for bushing mount only

Materials

BUSHING/HOUSING: PETP Thermoplastic
 STATIONARY CONTACTS & TERMINALS: Nickel Plated Brass with additional plating of Gold or Silver.
 ROTOR: Gold or Silver plated Brass or PCB.
 CODING PLATE: PA thermoplastic
 ACTUATOR: Polysulfon thermoplastic
 HARDWARE: Stop pin: Aluminum. Ball & Spring: Stainless steel. Washer: PA. Nut: Brass.

Environmental Data

OPERATING TEMPERATURE: -20°C to + 70°C -20°C to + 70°C
 STORAGE TEMPERATURE: -40°C to + 85°C -40°C to + 85°C

NOTE: Specifications and materials listed above are for switches with standard options. For information on specific and custom switches, consult Customer Service Center.

Build-A-Switch

To order, simply select desired option from each category and place in the appropriate box. Available options are shown and described on pages K-9 thru K-12. For additional options not shown in catalog, consult Customer Service Center.



Designation

RTA

Indexing

- 2** 22.5 index (coded only)
- 3** 30° index (12 positions max.)
- 4** 36° index (10 positions max.)

Termination

- P** With PC Thru-hole
- H** Horizontal with PC Thru-hole

Switch Function

- 1W12** SP, 30° Index, 12 pos. no stop
- 1W10** SP, 36° Index, 10 pos. no stop
- 1S02** SP, 30° /36° Index, 2 pos.
- 1S03** SP, 30° /36° Index, 3 pos.
- 1S04** SP, 30° /36° Index, 4 pos.
- 1S05** SP, 30° /36° Index, 5 pos.
- 1S06** SP, 30° /36° Index, 6 pos.
- 1S07** SP, 30° /36° Index, 7 pos.
- 1S08** SP, 30° /36° Index, 8 pos.
- 1S09** SP, 30° /36° Index, 9 pos.
- 1S10** SP, 30° /36° Index, 10 pos.
- 1S11** SP, 30° Index, 11 pos.
- 1S12** SP, 30° Index, 12 pos.
- 2S02** DP, 30° /36° Index, 2 pos.
- 2S03** DP, 30° /36° Index, 3 pos.
- 2S04** DP, 30° /36° Index, 4 pos.
- 2S05** DP, 30° /36° Index, 5 pos.
- 2S06** DP, 30° Index, 6 pos.

4S02 4P, 30° /36° Index, 2 pos.

EW10 Direct + complement, 36° Index, no stop

EW12 Direct + complement, 30° Index, no stop

ES__ Direct + complement, 30°/36° Index, with stop (specify stop position)

Mounting Style

- W** Without bushing
- R** 3/8-32 Threaded Bushing
- M** M10x.75 Metric Threaded Bushing
- A** 3/8-32 Threaded Bushing with Offset Bracket
- B** M10x.75 Metric Threaded Bushing with Offset Bracket

Contact Material

- S** Silver plated, matte-tin terminal
- P** Gold plated, matte-tin terminal

Actuator (max.)

- 25N** .984 (25,0) with screwdriver slot
- 50N** 1.97 (50,0) with screwdriver slot
- FLS** Flush shaft with screwdriver slot and position indicator
- 25F** .984 (25,0) Shaft with flat
- 06F** .236 (6,0) Shaft with flat

RTA Series 1-4 Poles Coded Rotary Switches

DESIGNATION

RTA



TERMINATION

P WITH PC PINS



H Horizontal with PC Thru-hole



Note: "H" termination only available with the following options:
 1. With A or B mounting styles
 2. 36° degree indexing
 3. Up to 5 positions max

INDEXING

- 2** 22.5 index, 16 positions max.
- 3** 30 index, 12 positions max.
- 4** 36 index, 10 positions max.

Both commons must be connected by user to ground.



K

Rotary

RTA Series 1-4 Poles Coded Rotary Switches

SWITCH FUNCTION

NO. POLES	MODEL NO.	SWITCH FUNCTION	INDEX
SP	1W12	12 Positions No Stop	30°
	1W10	10 Positions No Stop	36°
	1S02	2 Positions	30°/36°
	1S03	3 Positions	30°/36°
	1S05	5 Positions	30°/36°
	1S06	6 Positions	30°/36°
	1S08	8 Positions	30°/36°
	1S09	9 Positions	30°/36°
	1S10	10 Positions	30°/36°
	1S11	11 Positions	30°
	1S12	12 Positions	30°



MODEL NO.	SWITCH FUNCTION	INDEX
EW10	Direct + complement, No stop	36°
EW12	Direct + complement, No stop	30°
ES__	Direct + complement, with stop (specify stop position)	30° & 36°

NO. POLES	MODEL NO.	SWITCH FUNCTION	INDEX
DP	2W05	5 Positions No Stop	30°/36°
	2W06	6 Positions No Stop	30°
	2S02	2 Positions	30°/36°
	2S03	3 Positions	30°/36°
	2S04	4 Positions	30°/36°
	2S05	5 Positions	30°/36°
4P	4S02	2 Positions	30°/36°

22.5°	30°	36°	Pos.	1	2	3	4	5	6	7	8	9	10	11	12	13	14	15	16
Term.	Term.	Term.																	
E,J	M,N	L,N	C	•	•	•	•	•	•	•	•	•	•	•	•	•	•	•	•
F,I	H	D	1		•		•		•		•		•		•		•		•
D,K	D	B	2			•	•			•	•			•	•			•	•
A,N	A	I	4					•	•			•				•	•		
B	J	J	8									•	•	•	•			•	•
—	C	K	1	•		•		•		•		•		•		•		•	
—	K	H	2	•	•			•	•			•	•			•	•		
—	B	A	4	•	•	•	•					•	•	•	•				
—	I	C	8	•	•	•	•	•	•	•	•								

Indexing Option Code 2, 22.5 INDEXING ANGLE PCB LAYOUT

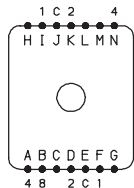

BCD ONLY

Indexing Option Code 3, 30 INDEXING ANGLE PCB LAYOUT

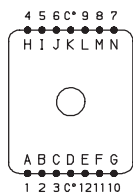

1 POLE

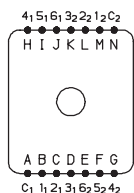

2 POLES



3 POLES

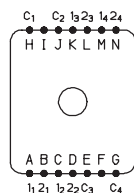

4 POLES

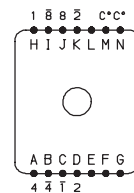

BCD + COMPLEMENTS

Indexing Option Code 4, 36 INDEXING ANGLE PCB LAYOUT



1 POLE



2 POLES

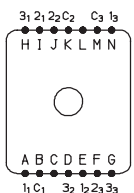

3 POLES

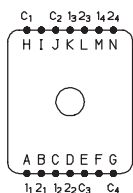

4 POLES

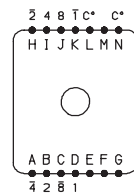

BCD + COMPLEMENTS

NOTE: Layout view from component side.

Common terminals that are in locations A-G are not connected to common terminals that are in locations H-N. For 7-12 position output customer must tie these commons together.



Third Angle Projection

Dimensions are shown: Inch (mm)

Specifications and dimensions subject to change



3 dec 18

RTA Series 1-4 Poles Coded Rotary Switches

MOUNTING STYLE

W WITHOUT BUSHING

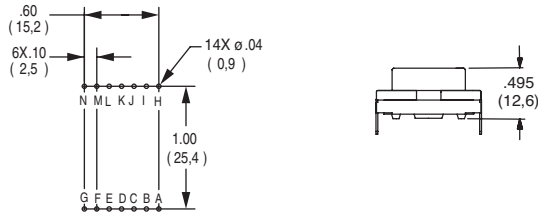

Note: W mounting style not available with H termination.

M M10 x .75 MERTIC THREADED BUSHING

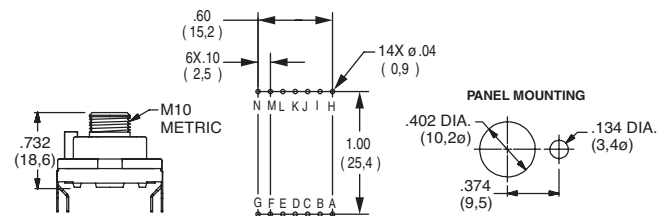

Note: M mounting style not available with H termination.

R 3/8-32 THREADED BUSHING

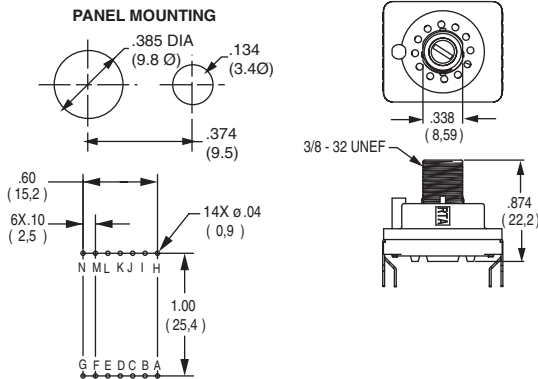

Note: R mounting style not available with H termination.

A 3/8-32 THREADED BUSHING WITH BRACKET

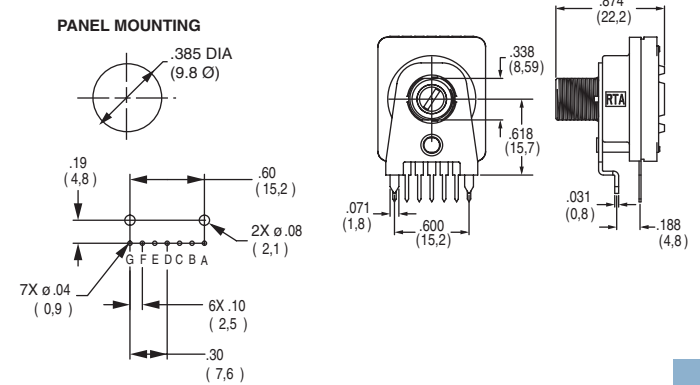

Note: A mounting style only available with H termination.

B M10 x .75 METRIC THREADED BUSHING WITH BRACKET

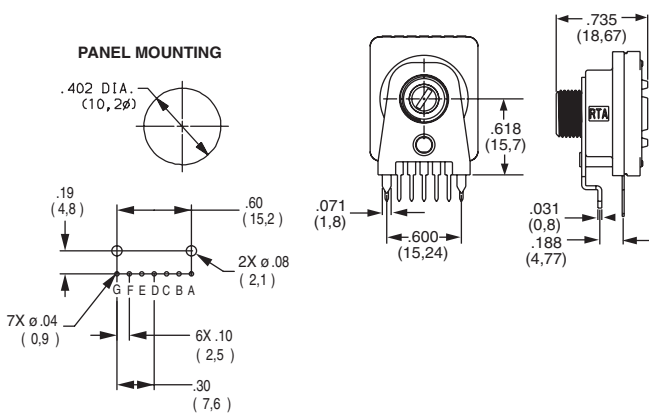

Note: B mounting style only available with H termination.

C 3/8-32 THREADED BUSHING WITH STRAIGHT BRACKET

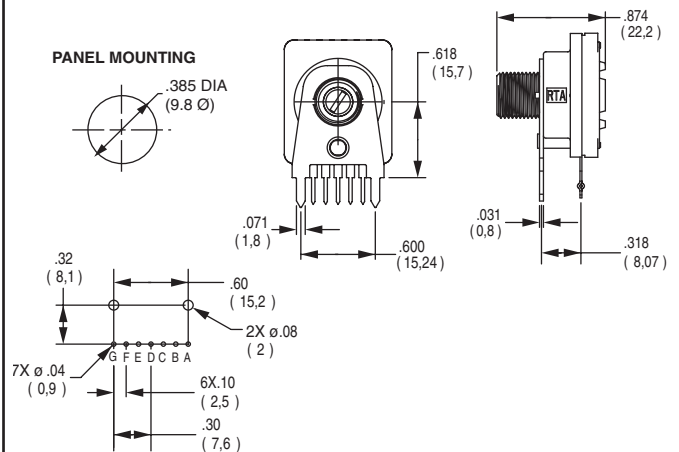

D M10 x .75 METRIC THREADED BUSHING WITH STRAIGHT BRACKET

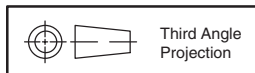
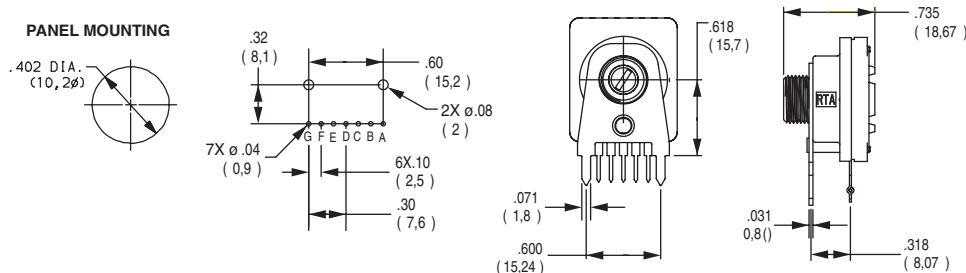

Third Angle
Projection

Dimensions are shown: Inch (mm)
Specifications and dimensions subject to change

RTA Series 1-4 Poles Coded Rotary Switches

ACTUATOR

25N .984 (25,0) WITH SCREWDRIVER SLOT

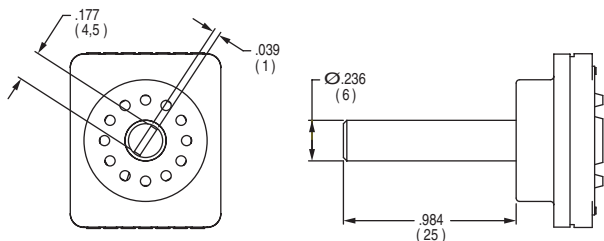

50N 1.97 (50,0) WITH SCREWDRIVER SLOT

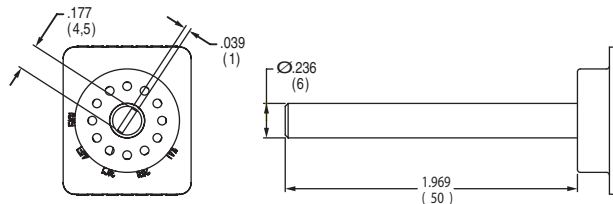

FLS FLUSH SHAFT WITH SCREWDRIVER SLOT AND POSITION INDICATOR

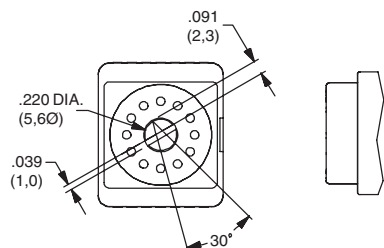

Note: only available with "W" Mounting Style

25F .984 (25,0) SHAFT WITH FLAT

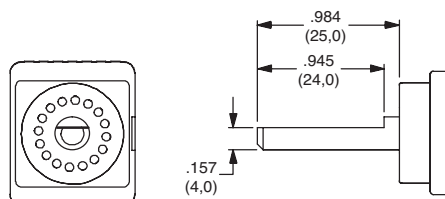

Note: only available with "W" Mounting Style

06F .236 (6,0) SHAFT WITH FLAT

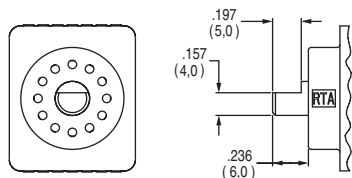

Note: only available with "W" Mounting Style

CONTACT MATERIAL

OPTION CODE	CONTACT AND TERMINAL MATERIAL	RATING	
S	SILVER	LOW LEVEL/DRY CIRCUIT	SWITCH: 150 mA MAXIMUM, 60 V NOMINAL. POWER: 5 VA MAXIMUM. CARRY-5 AMPS MAXIMUM.
P	GOLD	LOW LEVEL/DRY CIRCUIT OR POWER	SWITCH: 20 mA MAXIMUM, 25 V NOMINAL. POWER: 0.5 VA MAXIMUM. CARRY: 1 AMP MAXIMUM.

* Note: See Technical Data section of this catalog for RoHS compliant and compatible definition and specifications.

AVAILABLE HARDWARE

Mounting Nuts



PART NO.
472706201
Standard



PART NO.
495100201
Metric

Stop pins



PART NO.
Y200300200PCH

Lockwasher

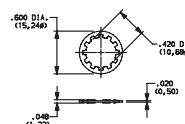

PART NO.
472800202

NOTE: Additional nuts and lockwashers available separately, see section "Technical Data and Additional Hardware".



Third Angle
Projection

Dimensions are shown: Inch (mm)
Specifications and dimensions subject to change

Компания «Океан Электроники» предлагает заключение долгосрочных отношений при поставках импортных электронных компонентов на взаимовыгодных условиях!

Наши преимущества:

- Поставка оригинальных импортных электронных компонентов напрямую с производств Америки, Европы и Азии, а так же с крупнейших складов мира;
- Широкая линейка поставок активных и пассивных импортных электронных компонентов (более 30 млн. наименований);
- Поставка сложных, дефицитных, либо снятых с производства позиций;
- Оперативные сроки поставки под заказ (от 5 рабочих дней);
- Экспресс доставка в любую точку России;
- Помощь Конструкторского Отдела и консультации квалифицированных инженеров;
- Техническая поддержка проекта, помощь в подборе аналогов, поставка прототипов;
- Поставка электронных компонентов под контролем ВП;
- Система менеджмента качества сертифицирована по Международному стандарту ISO 9001;
- При необходимости вся продукция военного и аэрокосмического назначения проходит испытания и сертификацию в лаборатории (по согласованию с заказчиком);
- Поставка специализированных компонентов военного и аэрокосмического уровня качества (Xilinx, Altera, Analog Devices, Intersil, Interpoint, Microsemi, Actel, Aeroflex, Peregrine, VPT, Syfer, Eurofarad, Texas Instruments, MS Kennedy, Miteq, Cobham, E2V, MA-COM, Hittite, Mini-Circuits, General Dynamics и др.);

Компания «Океан Электроники» является официальным дистрибьютором и эксклюзивным представителем в России одного из крупнейших производителей разъемов военного и аэрокосмического назначения «JONHON», а так же официальным дистрибьютором и эксклюзивным представителем в России производителя высокотехнологичных и надежных решений для передачи СВЧ сигналов «FORSTAR».



JONHON

«JONHON» (основан в 1970 г.)

Разъемы специального, военного и аэрокосмического назначения:

(Применяются в военной, авиационной, аэрокосмической, морской, железнодорожной, горно- и нефтедобывающей отраслях промышленности)

«FORSTAR» (основан в 1998 г.)

ВЧ соединители, коаксиальные кабели, кабельные сборки и микроволновые компоненты:

(Применяются в телекоммуникациях гражданского и специального назначения, в средствах связи, РЛС, а так же военной, авиационной и аэрокосмической отраслях промышленности).



Телефон: 8 (812) 309-75-97 (многоканальный)

Факс: 8 (812) 320-03-32

Электронная почта: ocean@oceanchips.ru

Web: <http://oceanchips.ru/>

Адрес: 198099, г. Санкт-Петербург, ул. Калинина, д. 2, корп. 4, лит. А