

**FEATURES****Fixed gain of 16 dB****Operation from 20 MHz to 1.0 GHz****Input and output internally matched to 50  $\Omega$** **Integrated bias control circuit****OIP3****45.5 dBm at 190 MHz****45.5 dBm at 380 MHz****Noise figure****3.2 dB at 190 MHz****3.3 dB at 380 MHz****P1dB of 18.9 dBm at 190 MHz****Single 5 V power supply****Low quiescent current of 97 mA****MSL-1 rated SOT-89 package****ESD rating of  $\pm 2$  kV (Class 2)****Pin-compatible with the 20 dB gain [ADL5536](#)****GENERAL DESCRIPTION**

The [ADL5535](#) is a 16 dB linear amplifier that operates at frequencies up to 1 GHz. The device can be used in a wide variety of cellular, CATV, military, and instrumentation equipment.

The [ADL5535](#) provides the highest dynamic range available from an internally matched IF gain block. This is accomplished by providing extremely low noise figures and very high OIP3 specifications simultaneously across the entire 1 GHz frequency range. The [ADL5535](#) also provides extremely flat gain and P1dB over frequency, which are stable over temperature, power supply, and from device to device.

The device is internally matched to 50  $\Omega$  at the input and output, making the [ADL5535](#) very easy to implement in a wide variety of applications. Only input/output ac coupling capacitors, power supply decoupling capacitors, and an external inductor are required for operation.

**FUNCTIONAL BLOCK DIAGRAM**

Figure 1.

The [ADL5535](#) is fabricated on a GaAs HBT process and has an ESD rating of  $\pm 2$  kV (Class 2). The device is assembled in an MSL-1 rated SOT-89 package that uses an exposed paddle for excellent thermal impedance.

The [ADL5535](#) consumes only 97 mA on a single 5 V supply and is fully specified for operation from  $-40^{\circ}\text{C}$  to  $+85^{\circ}\text{C}$ .

The [ADL5535](#) is also pin-compatible with the 20 dB gain [ADL5536](#). Fully populated evaluation boards are available for each amplifier.

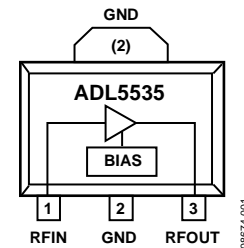
Rev. A

[Document Feedback](#)

Information furnished by Analog Devices is believed to be accurate and reliable. However, no responsibility is assumed by Analog Devices for its use, nor for any infringements of patents or other rights of third parties that may result from its use. Specifications subject to change without notice. No license is granted by implication or otherwise under any patent or patent rights of Analog Devices. Trademarks and registered trademarks are the property of their respective owners.

**TABLE OF CONTENTS**

|  |   |   |    |
|--|---|---|----|
| Features .....                                     | 1 | Basic Connections .....                       | 11 |
| Functional Block Diagram .....                     | 1 | Soldering Information and Recommended PCB     |    |
| General Description .....                          | 1 | Land Pattern.....                             | 11 |
| Revision History .....                             | 2 | ACPR Performance .....                        | 12 |
| Specifications.....                                | 3 | Error Vector Magnitude (EVM) Performance..... | 12 |
| Typical Scattering Parameters (S-Parameters) ..... | 5 | ADC Driving Application .....                 | 13 |
| Absolute Maximum Ratings.....                      | 6 | Evaluation Board .....                        | 14 |
| ESD Caution.....                                   | 6 | Outline Dimensions .....                      | 15 |
| Pin Configuration and Function Descriptions.....   | 7 | Ordering Guide .....                          | 15 |
| Typical Performance Characteristics .....          | 8 |   |    |

**REVISION HISTORY**

**9/13—Rev. 0 to Rev. A**

|  |    |
|--|----|
| Moved Figure 13 and Figure 14 .....            | 10 |
| Added Figure 15; Renumbered Sequentially ..... | 10 |
| Changes to Figure 17.....                      | 11 |
| Updated Outline Dimensions .....               | 15 |

**4/10—Revision 0: Initial Version**

## SPECIFICATIONS

$V_{CC} = 5\text{ V}$  and  $T_A = 25^\circ\text{C}$ , unless otherwise noted.

Table 1.

| Parameter                            | Test Conditions/Comments  | Min  | Typ        | Max  | Unit |
|--------------------------------------|---|------|------------|------|------|
| <b>OVERALL FUNCTION</b>              |   |      |            |      |      |
| Frequency Range                      |   | 20   |            | 1000 | MHz  |
| <b>FREQUENCY = 20 MHz</b>            |   |      |            |      |      |
| Gain                                 |   |      | 16.7       |      | dB   |
| Output 1 dB Compression Point (P1dB) |   |      | 17.7       |      | dBm  |
| Output Third-Order Intercept (OIP3)  | $\Delta f = 1\text{ MHz}$ , output power ( $P_{OUT}$ ) = 3 dBm per tone |      | 41.5       |      | dBm  |
| Second Harmonic                      | $P_{OUT} = 0\text{ dBm}$  |      | -59.5      |      | dBc  |
| Third Harmonic                       | $P_{OUT} = 0\text{ dBm}$  |      | -93        |      | dBc  |
| Noise Figure                         |   |      | 3.0        |      | dB   |
| <b>FREQUENCY = 70 MHz</b>            |   |      |            |      |      |
| Gain                                 |   |      | 16.5       |      | dB   |
| vs. Frequency                        | $\pm 50\text{ MHz}$   |      | $\pm 0.33$ |      | dB   |
| vs. Temperature                      | $-40^\circ\text{C} \leq T_A \leq +85^\circ\text{C}$                     |      | $\pm 0.16$ |      | dB   |
| vs. Supply Voltage                   | 4.75 V to 5.25 V  |      | $\pm 0.04$ |      | dB   |
| Output 1 dB Compression Point (P1dB) |   |      | 18.9       |      | dBm  |
| Output Third-Order Intercept (OIP3)  | $\Delta f = 1\text{ MHz}$ , output power ( $P_{OUT}$ ) = 3 dBm per tone |      | 43.5       |      | dBm  |
| Second Harmonic                      | $P_{OUT} = 0\text{ dBm}$  |      | -64        |      | dBc  |
| Third Harmonic                       | $P_{OUT} = 0\text{ dBm}$  |      | -93        |      | dBc  |
| Noise Figure                         |   |      | 3.0        |      | dB   |
| <b>FREQUENCY = 190 MHz</b>           |   |      |            |      |      |
| Gain                                 |   | 15.2 | 16.1       | 17.0 | dB   |
| vs. Frequency                        | $\pm 50\text{ MHz}$   |      | $\pm 0.06$ |      | dB   |
| vs. Temperature                      | $-40^\circ\text{C} \leq T_A \leq +85^\circ\text{C}$                     |      | $\pm 0.17$ |      | dB   |
| vs. Supply Voltage                   | 4.75 V to 5.25 V  |      | $\pm 0.04$ |      | dB   |
| Output 1 dB Compression Point (P1dB) |   | 17.8 | 18.9       |      | dBm  |
| Output Third-Order Intercept (OIP3)  | $\Delta f = 1\text{ MHz}$ , output power ( $P_{OUT}$ ) = 3 dBm per tone |      | 45.5       |      | dBm  |
| Second Harmonic                      | $P_{OUT} = 0\text{ dBm}$  |      | -60.2      |      | dBc  |
| Third Harmonic                       | $P_{OUT} = 0\text{ dBm}$  |      | -84.3      |      | dBc  |
| Noise Figure                         |   |      | 3.2        |      | dB   |
| <b>FREQUENCY = 380 MHz</b>           |   |      |            |      |      |
| Gain                                 |   | 15.0 | 15.8       | 16.5 | dB   |
| vs. Frequency                        | $\pm 50\text{ MHz}$   |      | $\pm 0.08$ |      | dB   |
| vs. Temperature                      | $-40^\circ\text{C} \leq T_A \leq +85^\circ\text{C}$                     |      | $\pm 0.17$ |      | dB   |
| vs. Supply Voltage                   | 4.75 V to 5.25 V  |      | $\pm 0.05$ |      | dB   |
| Output 1 dB Compression Point (P1dB) |   | 17.8 | 18.9       |      | dBm  |
| Output Third-Order Intercept (OIP3)  | $\Delta f = 1\text{ MHz}$ , output power ( $P_{OUT}$ ) = 3 dBm per tone |      | 45.5       |      | dBm  |
| Second Harmonic                      | $P_{OUT} = 0\text{ dBm}$  |      | -61.9      |      | dBc  |
| Third Harmonic                       | $P_{OUT} = 0\text{ dBm}$  |      | -75        |      | dBc  |
| Noise Figure                         |   |      | 3.3        |      | dB   |
| <b>FREQUENCY = 748 MHz</b>           |   |      |            |      |      |
| Gain                                 |   |      | 15.2       |      | dB   |
| vs. Frequency                        | $\pm 50\text{ MHz}$   |      | $\pm 0.10$ |      | dB   |
| vs. Temperature                      | $-40^\circ\text{C} \leq T_A \leq +85^\circ\text{C}$                     |      | $\pm 0.20$ |      | dB   |
| vs. Supply Voltage                   | 4.75 V to 5.25 V  |      | $\pm 0.06$ |      | dB   |
| Output 1 dB Compression Point (P1dB) |   |      | 18.9       |      | dBm  |
| Output Third-Order Intercept (OIP3)  | $\Delta f = 1\text{ MHz}$ , output power ( $P_{OUT}$ ) = 3 dBm per tone |      | 42.0       |      | dBm  |
| Second Harmonic                      | $P_{OUT} = 0\text{ dBm}$  |      | -52.6      |      | dBc  |
| Third Harmonic                       | $P_{OUT} = 0\text{ dBm}$  |      | -68        |      | dBc  |
| Noise Figure                         |   |      | 3.2        |      | dB   |

| Parameter                            | Test Conditions/Comments                                      | Min | Typ   | Max | Unit |
|--------------------------------------|---|-----|-------|-----|------|
| FREQUENCY = 900 MHz                  |   |     |       |     |      |
| Gain                                 |   |     | 15.1  |     | dB   |
| vs. Frequency                        | ±50 MHz   |     | ±0.11 |     | dB   |
| vs. Temperature                      | −40°C ≤ T <sub>A</sub> ≤ +85°C                                |     | ±0.20 |     | dB   |
| vs. Supply Voltage                   | 4.75 V to 5.25 V  |     | ±0.06 |     | dB   |
| Output 1 dB Compression Point (P1dB) |   |     | 19.0  |     | dBm  |
| Output Third-Order Intercept (OIP3)  | Δf = 1 MHz, output power (P <sub>OUT</sub> ) = 3 dBm per tone |     | 40.0  |     | dBm  |
| Second Harmonic                      | P <sub>OUT</sub> = 0 dBm                                      |     | −59.3 |     | dBc  |
| Third Harmonic                       | P <sub>OUT</sub> = 0 dBm                                      |     | −64.6 |     | dBc  |
| Noise Figure                         |   |     | 3.2   |     | dB   |
| FREQUENCY = 1000 MHz                 |   |     |       |     |      |
| Gain                                 |   |     | 14.9  |     | dB   |
| vs. Frequency                        | ±50 MHz   |     | ±0.11 |     | dB   |
| vs. Temperature                      | −40°C ≤ T <sub>A</sub> ≤ +85°C                                |     | ±0.21 |     | dB   |
| vs. Supply Voltage                   | 4.75 V to 5.25 V  |     | ±0.07 |     | dB   |
| Output 1 dB Compression Point (P1dB) |   |     | 18.9  |     | dBm  |
| Output Third-Order Intercept (OIP3)  | Δf = 1 MHz, output power (P <sub>OUT</sub> ) = 3 dBm per tone |     | 39.5  |     | dBm  |
| Second Harmonic                      | P <sub>OUT</sub> = 0 dBm                                      |     | −51.4 |     | dBc  |
| Third Harmonic                       | P <sub>OUT</sub> = 0 dBm                                      |     | −63.1 |     | dBc  |
| Noise Figure                         |   |     | 3.3   |     | dB   |
| POWER INTERFACE                      |   |     |       |     |      |
| Supply Voltage (V <sub>CC</sub> )    |   | 4.5 | 5.0   | 5.5 | V    |
| Supply Current                       |   |     | 97    | 115 | mA   |
| vs. Temperature                      | −40°C ≤ T <sub>A</sub> ≤ +85°C                                |     | ±2.0  |     | mA   |
| Power Dissipation                    | V <sub>CC</sub> = 5 V   |     | 0.5   |     | W    |

**TYPICAL SCATTERING PARAMETERS (S-PARAMETERS)**

$V_{CC} = 5\text{ V}$ ,  $T_A = 25^\circ\text{C}$ , and the effects of the test fixture have been de-embedded up to the pins of the device.

Table 2.

| Frequency (MHz) | S11            |           | S21            |           | S12            |           | S22            |           |
|-----------------|----------------|-----------|----------------|-----------|----------------|-----------|----------------|-----------|
|                 | Magnitude (dB) | Angle (°) | Magnitude (dB) | Angle (°) | Magnitude (dB) | Angle (°) | Magnitude (dB) | Angle (°) |
| 20              | -13.03         | -112.72   | 17.11          | 167.18    | -19.70         | +10.45    | -14.78         | -125.49   |
| 70              | -18.32         | -152.93   | 16.33          | 171.17    | -19.67         | +0.77     | -15.85         | -161.12   |
| 120             | -19.04         | -161.05   | 16.22          | 169.68    | -19.66         | -1.99     | -15.99         | -166.87   |
| 190             | -19.31         | -163.81   | 16.16          | 166.09    | -19.65         | -4.89     | -15.97         | -168.23   |
| 240             | -19.35         | -163.54   | 16.10          | 163.36    | -19.65         | -6.74     | -15.91         | -167.75   |
| 290             | -19.26         | -162.62   | 16.08          | 160.44    | -19.65         | -8.54     | -15.81         | -166.89   |
| 340             | -19.24         | -161.59   | 16.01          | 157.37    | -19.66         | -10.20    | -15.70         | -166.07   |
| 390             | -19.12         | -158.71   | 15.94          | 154.60    | -19.65         | -11.99    | -15.53         | -164.46   |
| 440             | -18.88         | -157.70   | 15.91          | 151.65    | -19.65         | -13.65    | -15.28         | -163.07   |
| 490             | -18.58         | -157.00   | 15.84          | 148.72    | -19.69         | -15.34    | -15.02         | -162.82   |
| 540             | -18.35         | -156.08   | 15.80          | 145.67    | -19.71         | -16.97    | -14.80         | -162.40   |
| 590             | -18.12         | -154.28   | 15.71          | 142.80    | -19.70         | -18.60    | -14.58         | -161.54   |
| 640             | -17.82         | -153.50   | 15.67          | 139.94    | -19.71         | -20.26    | -14.31         | -161.17   |
| 690             | -17.57         | -152.78   | 15.59          | 136.89    | -19.73         | -21.87    | -14.07         | -160.95   |
| 740             | -17.30         | -151.90   | 15.51          | 134.11    | -19.74         | -23.49    | -13.82         | -160.76   |
| 790             | -17.04         | -151.31   | 15.44          | 131.17    | -19.75         | -25.11    | -13.58         | -160.71   |
| 840             | -16.76         | -150.77   | 15.35          | 128.31    | -19.77         | -26.74    | -13.34         | -160.76   |
| 900             | -16.41         | -150.20   | 15.26          | 125.01    | -19.79         | -28.65    | -13.05         | -160.99   |
| 950             | -16.15         | -149.94   | 15.17          | 122.08    | -19.80         | -30.29    | -12.82         | -161.31   |
| 1000            | -15.87         | -149.69   | 15.08          | 119.42    | -19.82         | -31.88    | -12.59         | -161.67   |
| 1050            | -15.60         | -149.72   | 15.00          | 116.58    | -19.84         | -33.51    | -12.38         | -162.13   |
| 1100            | -15.35         | -149.61   | 14.89          | 113.89    | -19.86         | -35.10    | -12.17         | -162.71   |
| 1150            | -15.08         | -149.74   | 14.81          | 111.22    | -19.88         | -36.69    | -11.97         | -163.25   |
| 1200            | -14.86         | -149.84   | 14.70          | 108.43    | -19.90         | -38.29    | -11.79         | -163.86   |
| 1250            | -14.58         | -149.97   | 14.61          | 105.97    | -19.92         | -39.90    | -11.59         | -164.52   |
| 1300            | -14.35         | -150.33   | 14.52          | 103.20    | -19.94         | -41.52    | -11.41         | -165.22   |
| 1350            | -14.11         | -150.67   | 14.41          | 100.66    | -19.96         | -43.13    | -11.25         | -166.05   |
| 1400            | -13.90         | -151.10   | 14.32          | 98.10     | -19.99         | -44.68    | -11.08         | -166.79   |
| 1450            | -13.69         | -151.43   | 14.21          | 95.51     | -20.02         | -46.23    | -10.93         | -167.47   |
| 1500            | -13.46         | -151.86   | 14.11          | 93.03     | -20.04         | -47.82    | -10.78         | -168.33   |
| 1550            | -13.26         | -152.41   | 14.02          | 90.50     | -20.06         | -49.37    | -10.63         | -169.12   |

## ABSOLUTE MAXIMUM RATINGS

Table 3.

| Parameter                                    | Rating          |
|--|-----------------|
| Supply Voltage, $V_{CC}$                     | 6.5 V           |
| Input Power (Referred to 50 $\Omega$ )       | 20 dBm          |
| Internal Power Dissipation (Paddle Soldered) | 650 mW          |
| $\theta_{JA}$ (Junction to Air)              | 30.7°C/W        |
| $\theta_{JC}$ (Junction to Paddle)           | 5.0°C/W         |
| Maximum Junction Temperature                 | 150°C           |
| Lead Temperature (Soldering, 60 sec)         | 240°C           |
| Operating Temperature Range                  | -40°C to +85°C  |
| Storage Temperature Range                    | -65°C to +150°C |

Stresses above those listed under Absolute Maximum Ratings may cause permanent damage to the device. This is a stress rating only; functional operation of the device at these or any other conditions above those indicated in the operational section of this specification is not implied. Exposure to absolute maximum rating conditions for extended periods may affect device reliability.

### ESD CAUTION



**ESD (electrostatic discharge) sensitive device.** Charged devices and circuit boards can discharge without detection. Although this product features patented or proprietary protection circuitry, damage may occur on devices subjected to high energy ESD. Therefore, proper ESD precautions should be taken to avoid performance degradation or loss of functionality.

## PIN CONFIGURATION AND FUNCTION DESCRIPTIONS

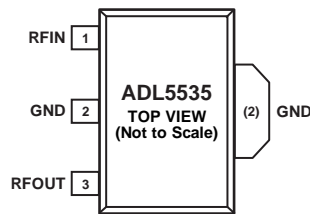

**NOTES**  
 1. THE EXPOSED PADDLE IS INTERNALLY CONNECTED TO GND AND MUST BE SOLDERED TO A LOW IMPEDANCE GROUND PLANE.

08674-002

Figure 2. Pin Configuration

Table 4. Pin Function Descriptions

| Pin No. | Mnemonic       | Description   |
|---------|----------------|---|
| 1       | RFIN           | RF Input. This pin requires a dc blocking capacitor.  |
| 2       | GND            | Ground. Connect this pin to a low impedance ground plane.   |
| 3       | RFOUT          | RF Output and Supply Voltage. A dc bias is provided to this pin through an inductor that is connected to the external power supply. The RF path requires a dc blocking capacitor. |
| (2)     | Exposed Paddle | Exposed Paddle. The exposed paddle is internally connected to GND and must be soldered to a low impedance ground plane.   |

TYPICAL PERFORMANCE CHARACTERISTICS

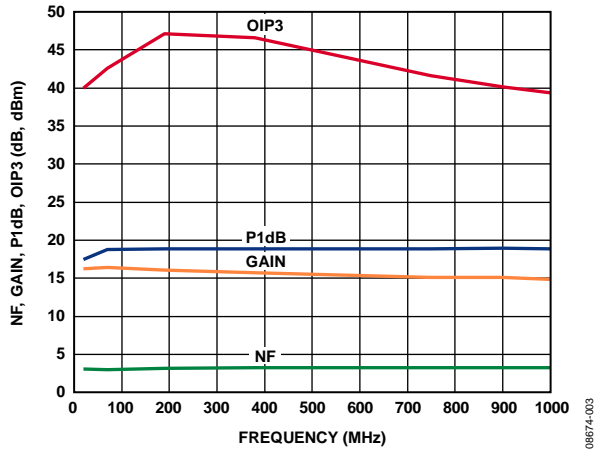

Figure 3. Noise Figure, Gain, P1dB, and OIP3 vs. Frequency

08674-003

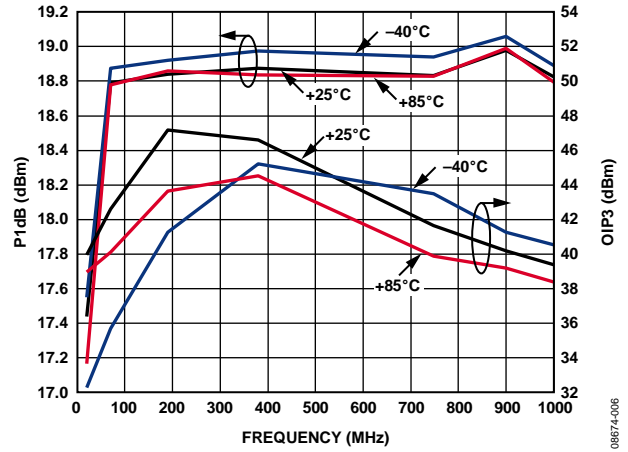

Figure 6. P1dB and OIP3 vs. Frequency and Temperature

08674-006

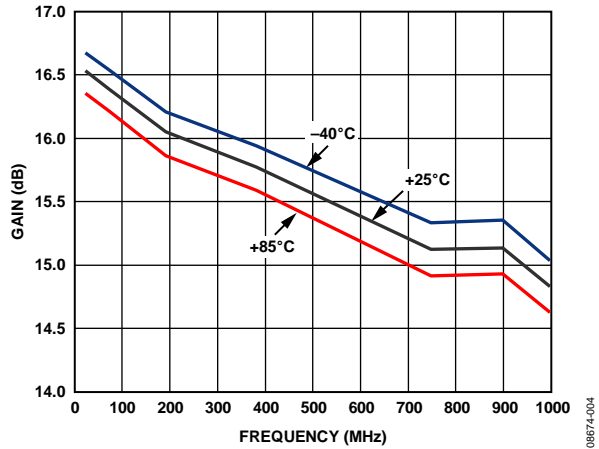

Figure 4. Gain vs. Frequency and Temperature

08674-004

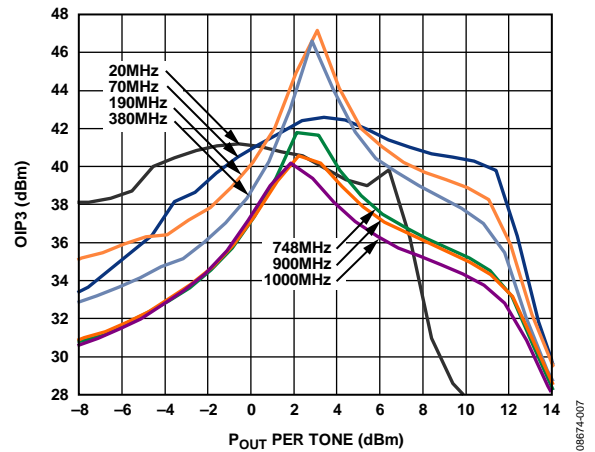

Figure 7. OIP3 vs. Output Power ( $P_{OUT}$ ) and Frequency

08674-007

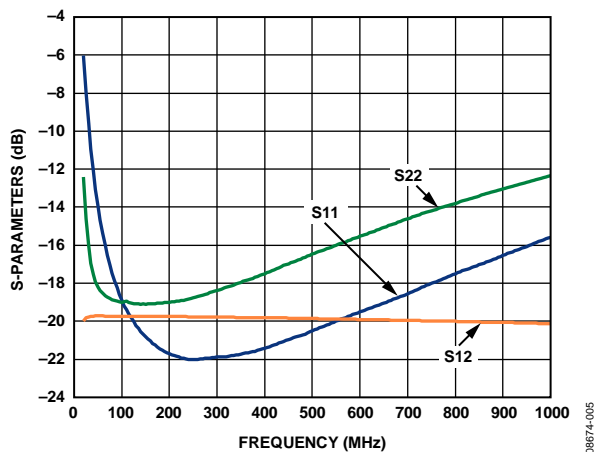

Figure 5. Input Return Loss (S11), Output Return Loss (S22), and Reverse Isolation (S12) vs. Frequency

08674-005

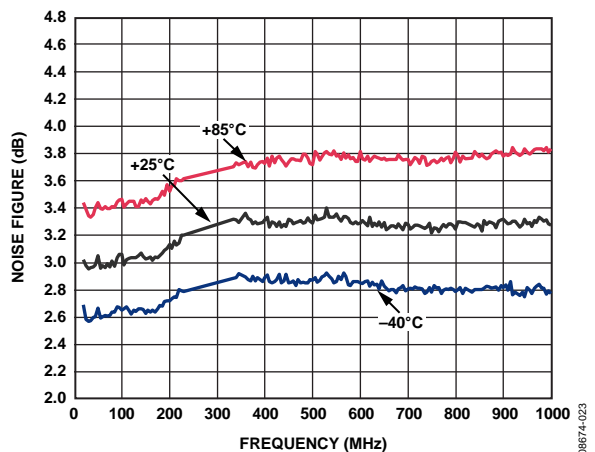

Figure 8. Noise Figure vs. Frequency and Temperature

08674-023



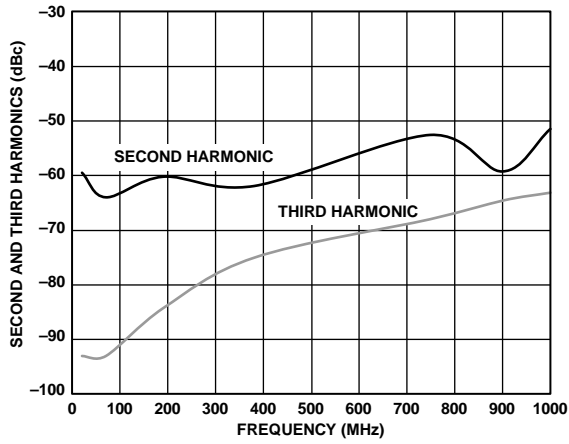

Figure 9. Single-Tone Harmonics vs. Frequency,  $P_{OUT} = 0$  dBm

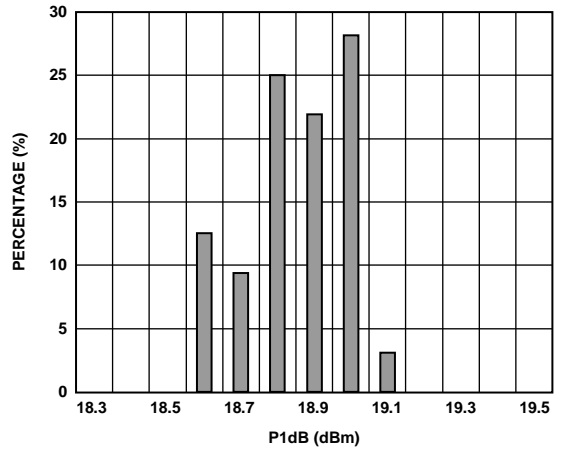

Figure 11. P1dB Distribution at 190 MHz

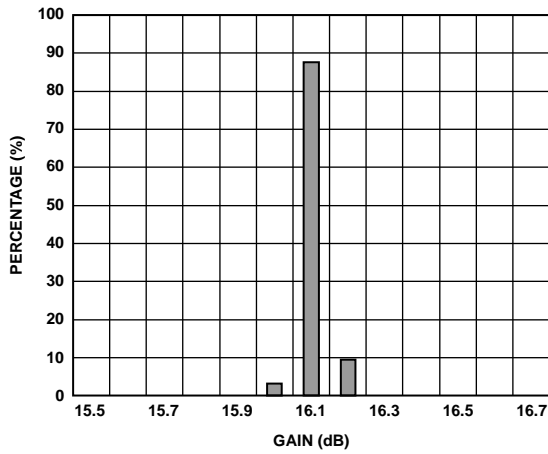

Figure 10. Gain Distribution at 190 MHz

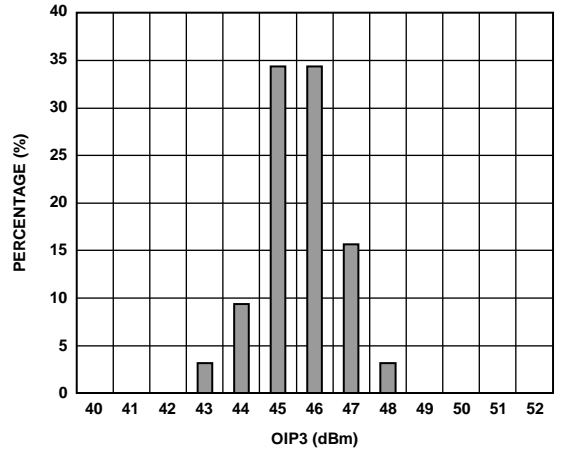

Figure 12. OIP3 Distribution at 190 MHz,  $P_{OUT} = 3$  dBm

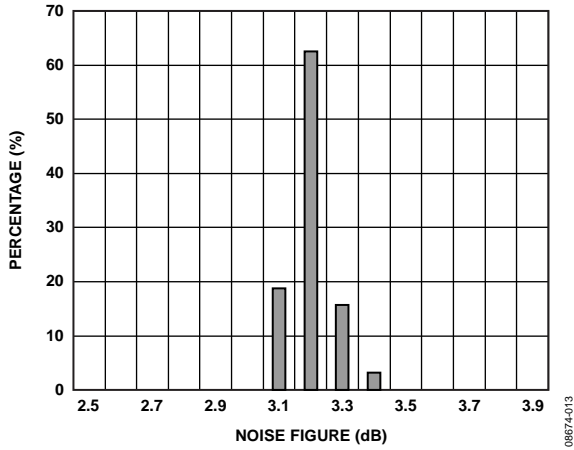

Figure 13. Noise Figure Distribution at 190 MHz

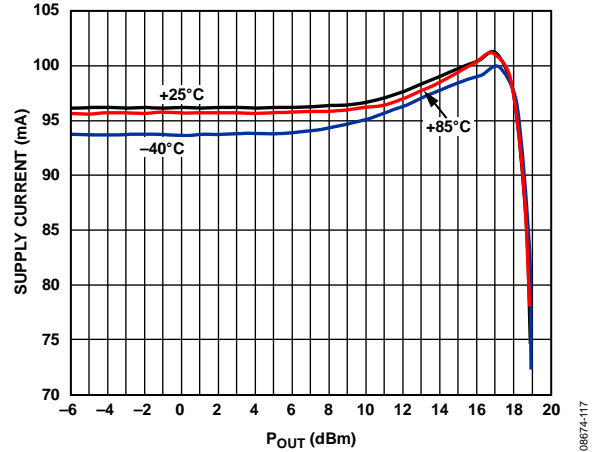

Figure 15. Supply Current vs. P<sub>OUT</sub> at Various Temperatures

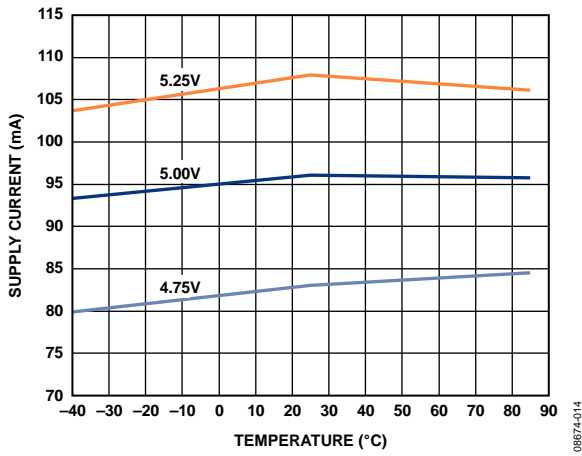

Figure 14. Supply Current vs. Temperature

### BASIC CONNECTIONS

The basic connections for operating the ADL5535 are shown in Figure 16. Recommended components are listed in Table 5. The input and output should be ac-coupled with appropriately sized capacitors (device characterization was performed with 0.1  $\mu$ F capacitors). A 5 V dc bias is supplied to the amplifier through the bias inductor connected to RFOUT (Pin 3). The bias voltage should be decoupled using a 1  $\mu$ F capacitor, a 1.2 nF capacitor, and a 68 pF capacitor.

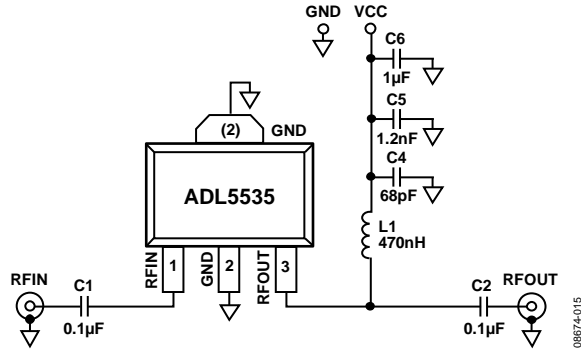

Figure 16. Basic Connections

### SOLDERING INFORMATION AND RECOMMENDED PCB LAND PATTERN

Figure 17 shows the recommended land pattern for the ADL5535. To minimize thermal impedance, the exposed paddle on the package underside, along with Pin 2, should be soldered to a ground plane. If multiple ground layers exist, they should be stitched together using vias. For more information about land pattern design and layout, refer to the AN-772 Application Note, A Design and Manufacturing Guide for the Lead Frame Chip Scale Package (LFCSP).

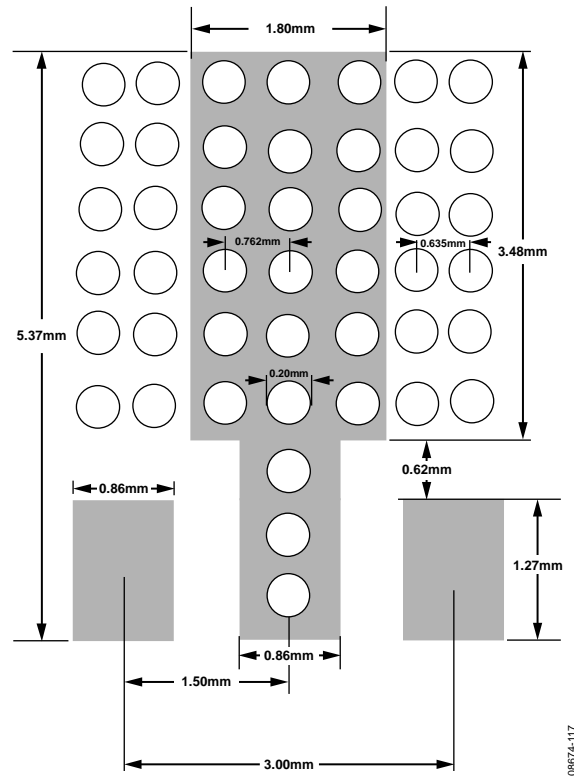

Figure 17. Recommended Land Pattern

Table 5. Recommended Components for Basic Connections

| Frequency          | C1          | C2          | L1   | C4    | C5     | C6        |
|--------------------|-------------|-------------|--|-------|--------|-----------|
| 20 MHz to 1000 MHz | 0.1 $\mu$ F | 0.1 $\mu$ F | 470 nH (Coilcraft 0603LS-NX or equivalent) | 68 pF | 1.2 nF | 1 $\mu$ F |

### ACPR PERFORMANCE

Figure 18 shows a plot of the adjacent channel power ratio (ACPR) vs.  $P_{OUT}$  for the ADL5535. The signal type used is a single wideband code division multiple access (W-CDMA) carrier (Test Model 1-64). This signal is generated by a very low ACPR source. ACPR is measured at the output by a high dynamic range spectrum analyzer that incorporates an instrument noise-correction function. At an output power level of +8 dBm, ACPR is still very low at -65 dBc, making the device suitable for use in driver applications.

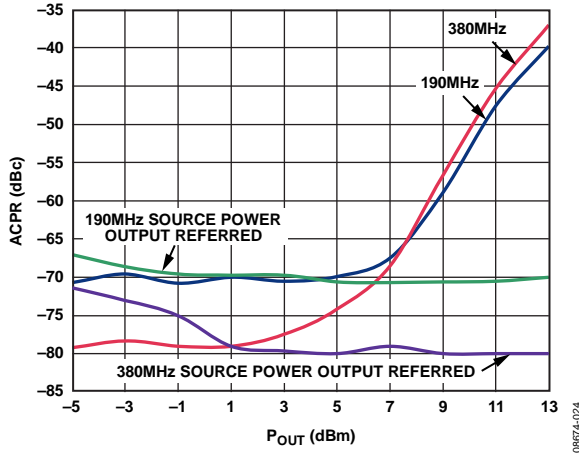

Figure 18. ACPR vs.  $P_{OUT}$ , Single W-CDMA Carrier (Test Model 1-64) at 190 MHz and 380 MHz

### ERROR VECTOR MAGNITUDE (EVM) PERFORMANCE

Error vector magnitude (EVM) is a measure used to quantify the performance of a digital radio transmitter or receiver. A signal received by a receiver has all constellation points at their ideal locations; however, various imperfections in the implementation (such as magnitude imbalance, noise floor, and phase imbalance) cause the actual constellation points to deviate from their ideal locations. The ADL5535 shows excellent performance when used with higher-order modulation schemes, such as a 16 QAM.

Figure 19 illustrates the EVM performance of the ADL5535 when driven with a 16 QAM 10 Msym/s signal. Degradation of the EVM performance starts to occur at an output power of +12 dBm.

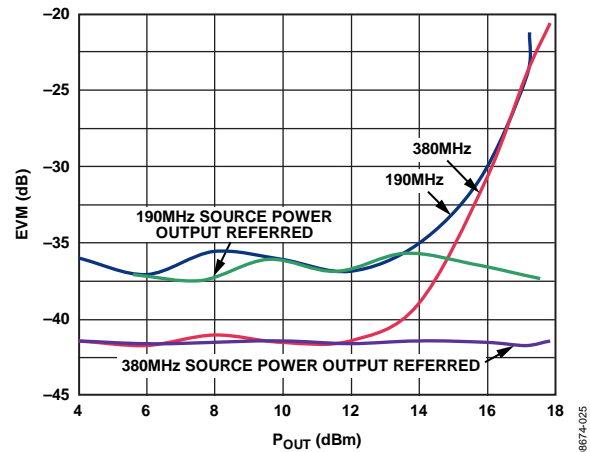

Figure 19. EVM Performance vs.  $P_{OUT}$  with a 16 QAM, 10 Msym/s Signal

### ADC DRIVING APPLICATION

The ADL5535 is a high linearity, fixed gain IF amplifier suitable for use as an ADC driver. Figure 23 shows the schematic of the ADL5535 driving the AD9268 16-bit analog-to-digital converter (ADC). The ADL5535 has a single-ended input and output impedance of 50 Ω. A 1:1 impedance transformer, along with termination resistors and series ferrite beads, are used to present a 50 Ω load for the antialiasing filter interface. The filter interface between the ADL5535 and the AD9268 is a sixth-order Butterworth low-pass filter. The interface provides a 50 MHz, 1 dB bandwidth centered around 175 MHz. Following the sixth-order filter, a shunt LC tank circuit was inserted to further reduce the low frequency response of the filter, giving more of a band-pass response to the filter. The normalized wideband response is shown in Figure 20.

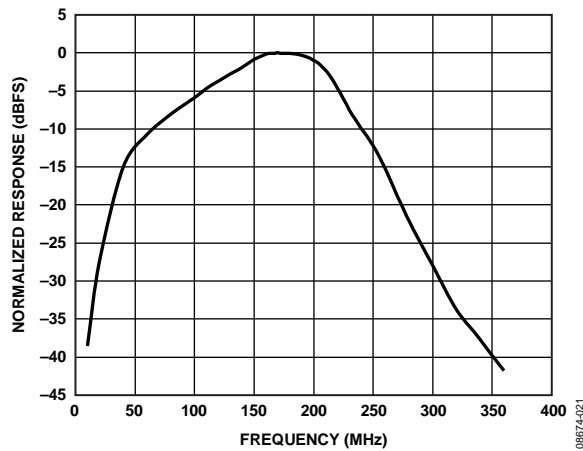

Figure 20. Normalized Response of the ADC Interface Shown in Figure 23

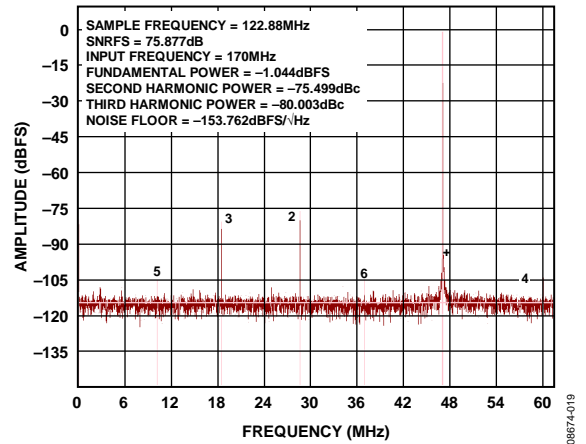

Figure 21. Measured Single-Tone Performance of the Circuit Shown in Figure 23

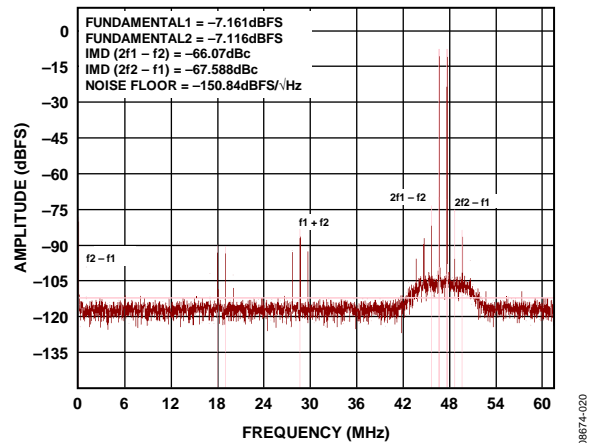

Figure 22. Measured Two-Tone Performance of the Circuit Shown in Figure 23

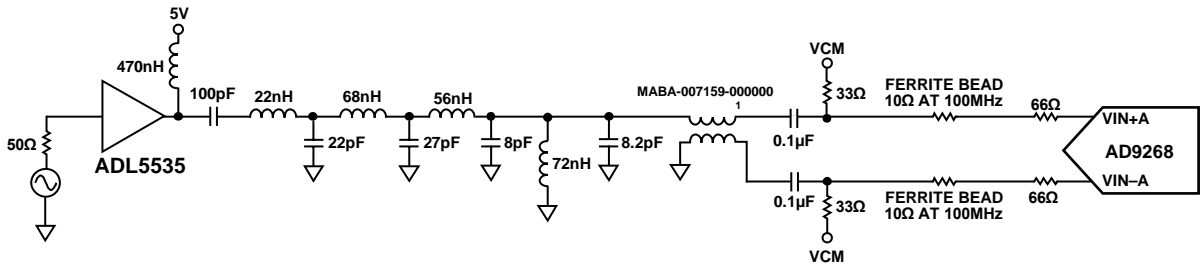

Figure 23. Schematic of the ADL5535 Driving the AD9268 16-Bit ADC

### EVALUATION BOARD

Figure 24 shows the evaluation board layout, and Figure 25 shows the schematic for the ADL5535 evaluation board. The board is powered by a single 5 V supply.

The components used on the board are listed in Table 6. Power can be applied to the board through clip-on leads (VCC and GND).

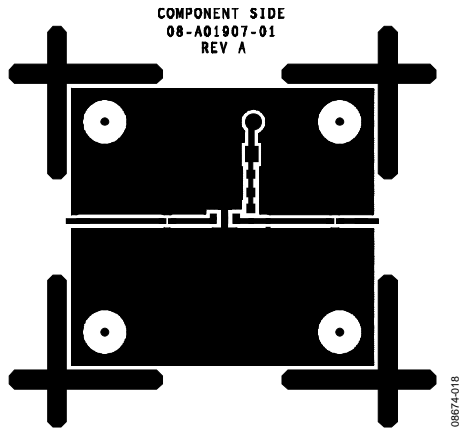

Figure 24. Evaluation Board Layout (Top)

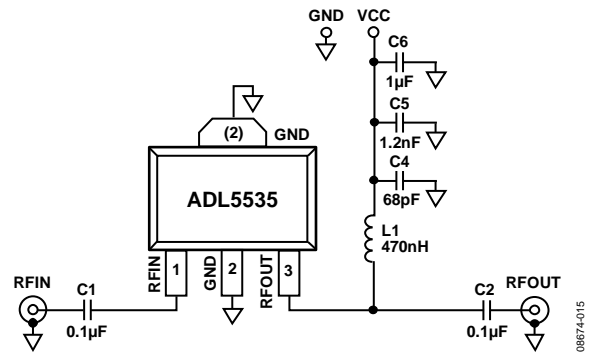
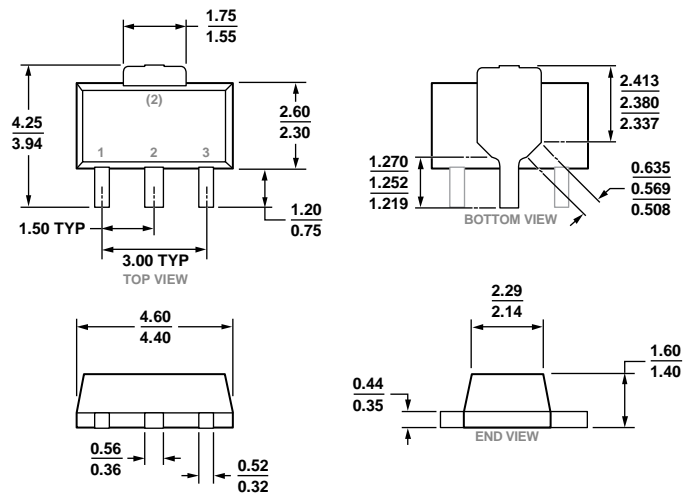

Figure 25. Evaluation Board Schematic

Table 6. Evaluation Board Components

| Component | Description                        | Default Value                                    |
|-----------|------------------------------------|--|
| C1, C2    | AC coupling capacitors             | 0.1 μF, 0402                                     |
| L1        | DC bias inductor                   | 470 nH, 0603 (Coilcraft 0603LS-NX or equivalent) |
| VCC, GND  | Clip-on terminals for power supply |  |
| C4        | Power supply decoupling capacitor  | 68 pF, 0603                                      |
| C5        | Power supply decoupling capacitor  | 1.2 nF, 0603                                     |
| C6        | Power supply decoupling capacitor  | 1 μF, 1206                                       |

# OUTLINE DIMENSIONS



PROPOSED

09-12-2013-C

COMPLIANT TO JEDEC STANDARDS TO-243

Figure 26. 3-Lead Small Outline Transistor Package [SOT-89] (RK-3)  
Dimensions shown in millimeters

## ORDERING GUIDE

| Model <sup>1</sup> | Temperature Range | Package Description             | Package Option |
|--------------------|-------------------|---------------------------------|----------------|
| ADL5535ARKZ-R7     | -40°C to +85°C    | 3-Lead SOT-89, 7" Tape and Reel | RK-3           |
| ADL5535-EVALZ      |                   | Evaluation Board                |                |

<sup>1</sup> Z = RoHS Compliant Part.

**NOTES**



Компания «Океан Электроники» предлагает заключение долгосрочных отношений при поставках импортных электронных компонентов на взаимовыгодных условиях!

Наши преимущества:

- Поставка оригинальных импортных электронных компонентов напрямую с производств Америки, Европы и Азии, а так же с крупнейших складов мира;
- Широкая линейка поставок активных и пассивных импортных электронных компонентов (более 30 млн. наименований);
- Поставка сложных, дефицитных, либо снятых с производства позиций;
- Оперативные сроки поставки под заказ (от 5 рабочих дней);
- Экспресс доставка в любую точку России;
- Помощь Конструкторского Отдела и консультации квалифицированных инженеров;
- Техническая поддержка проекта, помощь в подборе аналогов, поставка прототипов;
- Поставка электронных компонентов под контролем ВП;
- Система менеджмента качества сертифицирована по Международному стандарту ISO 9001;
- При необходимости вся продукция военного и аэрокосмического назначения проходит испытания и сертификацию в лаборатории (по согласованию с заказчиком);
- Поставка специализированных компонентов военного и аэрокосмического уровня качества (Xilinx, Altera, Analog Devices, Intersil, Interpoint, Microsemi, Actel, Aeroflex, Peregrine, VPT, Syfer, Eurofarad, Texas Instruments, MS Kennedy, Miteq, Cobham, E2V, MA-COM, Hittite, Mini-Circuits, General Dynamics и др.);

Компания «Океан Электроники» является официальным дистрибьютором и эксклюзивным представителем в России одного из крупнейших производителей разъемов военного и аэрокосмического назначения «JONHON», а так же официальным дистрибьютором и эксклюзивным представителем в России производителя высокотехнологичных и надежных решений для передачи СВЧ сигналов «FORSTAR».



## JONHON

«JONHON» (основан в 1970 г.)

Разъемы специального, военного и аэрокосмического назначения:

(Применяются в военной, авиационной, аэрокосмической, морской, железнодорожной, горно- и нефтедобывающей отраслях промышленности)

«FORSTAR» (основан в 1998 г.)

ВЧ соединители, коаксиальные кабели, кабельные сборки и микроволновые компоненты:

(Применяются в телекоммуникациях гражданского и специального назначения, в средствах связи, РЛС, а так же военной, авиационной и аэрокосмической отраслях промышленности).



Телефон: 8 (812) 309-75-97 (многоканальный)

Факс: 8 (812) 320-03-32

Электронная почта: [ocean@oceanchips.ru](mailto:ocean@oceanchips.ru)

Web: <http://oceanchips.ru/>

Адрес: 198099, г. Санкт-Петербург, ул. Калинина, д. 2, корп. 4, лит. А