

Features

- Excellent thermal stability
- Common source configuration
- Broadband performances $P_{OUT} = 2\text{ W}$ with 13 dB gain @ 870 MHz
- Plastic package
- ESD protection
- Supplied in tape and reel
- In compliance with the 2002/95/EC european directive

Description

The PD84002 is a common source N-channel, enhancement-mode lateral Field-Effect RF power transistor. It is designed for high gain, broad band commercial and industrial applications. It operates at 7 V in common source mode at frequencies of up to 1 GHz.

PD84002's superior gain and efficiency makes it an ideal solution for portable radio and UHF RFID reader.

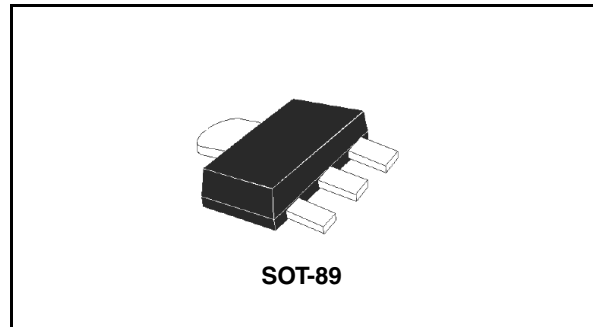

Figure 1. Pin connection

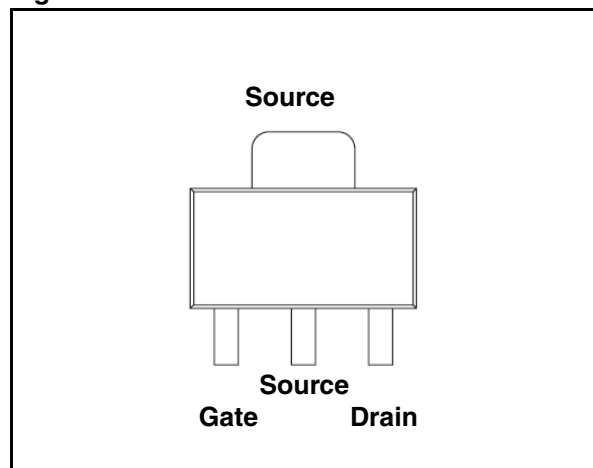

Figure 2. Device summary

Order code	Marking	Package	Packaging
PD84002	8402	SOT-89	Tape and reel

Contents

- 1 Electrical data 3**
 - 1.1 Maximum ratings 3
 - 1.2 Thermal data 3

- 2 Electrical characteristics 4**
 - 2.1 Static 4
 - 2.2 Dynamic 4
 - 2.3 ESD protection characteristics 4
 - 2.4 Moisture sensitivity level 4

- 3 Impedances 5**

- 4 DC curves 6**

- 5 RF curves 7**

- 6 Schematic and BOM 8**

- 7 Photo 9**

- 8 Package mechanical data 10**
 - 8.1 Thermal Pad and Via design 12
 - 8.2 Soldering profile 13

- 9 Revision history 15**

1 Electrical data

1.1 Maximum ratings

Table 1. Absolute maximum ratings ($T_{CASE} = 25^{\circ}C$)

Symbol	Parameter	Value	Unit
$V_{(BR)DSS}$	Drain-source voltage	25	V
V_{GS}	Gate-source voltage	-0.5 to +15	V
I_D	Drain current	2	A
P_{DISS}	Power dissipation	6	W
T_J	Max. operating junction temperature	150	$^{\circ}C$
T_{STG}	Storage temperature	-65 to +150	$^{\circ}C$

1.2 Thermal data

Table 2. Thermal data

Symbol	Parameter	Value	Unit
R_{thJC}	Junction - case thermal resistance	21	$^{\circ}C/W$

2 Electrical characteristics

$$T_{CASE} = +25\text{ }^{\circ}\text{C}$$

2.1 Static

Table 3. Static

Symbol	Test conditions		Min	Typ	Max	Unit
I_{DSS}	$V_{GS} = 0\text{ V}$	$V_{DS} = 25\text{ V}$			1	μA
I_{GSS}	$V_{GS} = 5\text{ V}$	$V_{DS} = 0\text{ V}$			1	μA
$V_{GS(Q)}$	$V_{DS} = 7.5\text{ V}$	$I_D = 100\text{ mA}$		3.9		V
$V_{DS(ON)}$	$V_{GS} = 10\text{ V}$	$I_D = 0.25\text{ A}$		0.27		V
C_{ISS}	$V_{GS} = 0\text{ V}$	$V_{DS} = 7.5\text{ V}$	$f = 1\text{ MHz}$	16		pF
C_{OSS}	$V_{GS} = 0\text{ V}$	$V_{DS} = 7.5\text{ V}$	$f = 1\text{ MHz}$	16		pF
C_{RSS}	$V_{GS} = 0\text{ V}$	$V_{DS} = 7.5\text{ V}$	$f = 1\text{ MHz}$	1.2		pF

2.2 Dynamic

Table 4. Dynamic

Symbol	Test conditions	Min	Typ	Max	Unit
P_{OUT}	$V_{DD} = 7.5\text{ V}$, $I_{DQ} = 100\text{ mA}$, $P_{IN} = 0.1\text{ W}$, $f = 870\text{ MHz}$	2			W
G_{PS}	$V_{DD} = 7.5\text{ V}$, $I_{DQ} = 100\text{ mA}$, $P_{OUT} = 2\text{ W}$, $f = 870\text{ MHz}$	13	15		dB
N_D	$V_{DD} = 7.5\text{ V}$, $I_{DQ} = 100\text{ mA}$, $P_{OUT} = 2\text{ W}$, $f = 870\text{ MHz}$	60	65		%
Load mismatch	$V_{DD} = 7.5\text{ V}$, $I_{DQ} = 100\text{ mA}$, $P_{OUT} = 2\text{ W}$, $f = 870\text{ MHz}$ All phase angles	20:1			VSWR

2.3 ESD protection characteristics

Table 5. ESD protection characteristics

Test conditions	Class
Human body model	2
Machine model	M3

2.4 Moisture sensitivity level

Table 6. Moisture sensitivity level

Test methodology	Rating
J-STD-020B	MSL 3

3 Impedances

Figure 3. Impedances

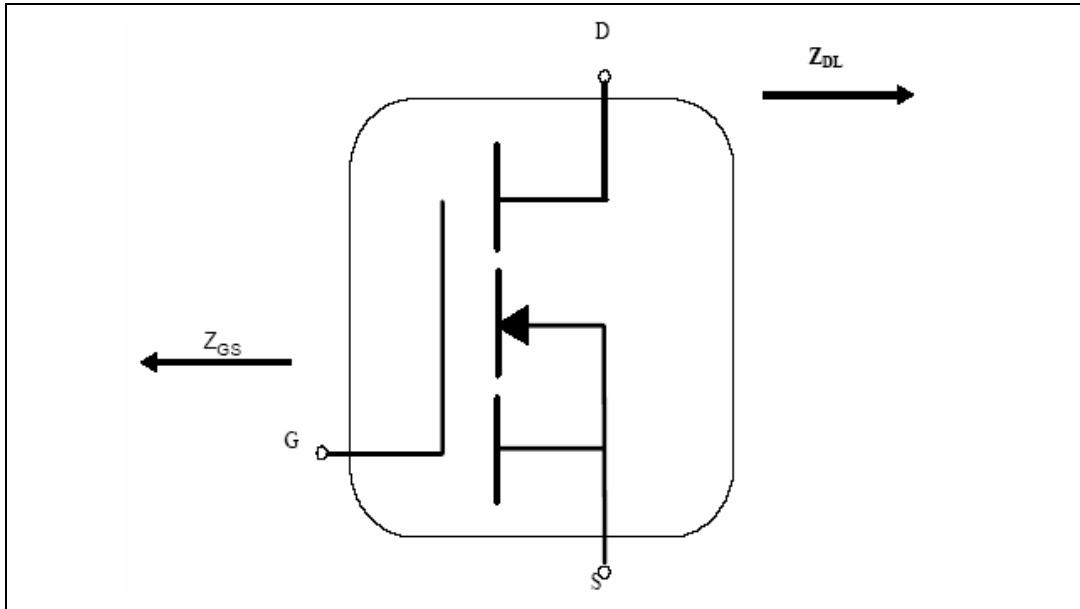

Table 7. Impedances

F(MHz)	Z_{GS}	Z_{DL}
860	$1,80 + j 7,79$	$3,88 + j 2,41$
870	$1,84 + j 7,96$	$3,89 + j 2,69$
880	$1,83 + j 8,01$	$4,01 + j 2,96$
890	$1,76 + j 8,11$	$4,17 + j 3,16$
900	$1,70 + j 8,20$	$4,27 + j 3,32$
910	$1,63 + j 8,30$	$4,37 + j 3,40$
920	$1,57 + j 8,48$	$4,41 + j 3,46$
930	$1,43 + j 8,64$	$4,36 + j 3,51$
940	$1,41 + j 8,83$	$4,28 + j 3,51$

4 DC curves

Figure 4. DC output characteristics

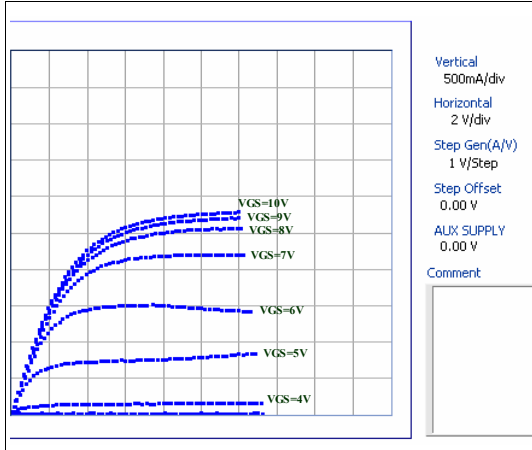

Figure 5. ID vs VGS

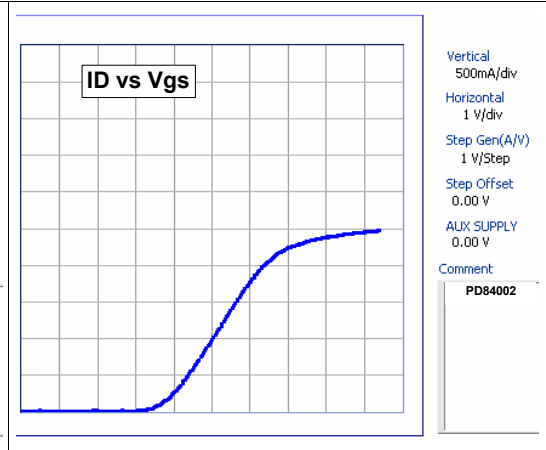
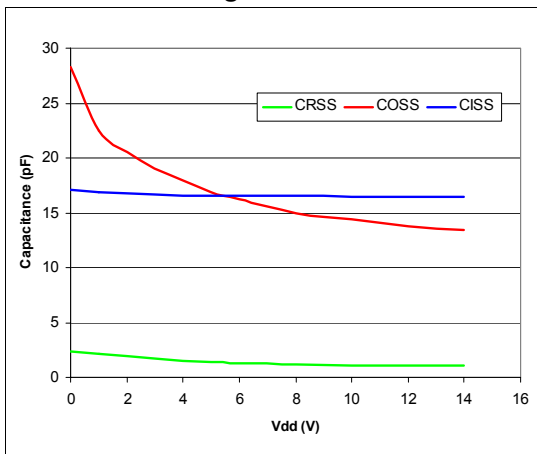

Figure 6. Capacitances vs drain voltage



5 RF curves

Figure 7. Output power and efficiency vs frequency 7.2 V / 100 mA / Pin = 19 dBm

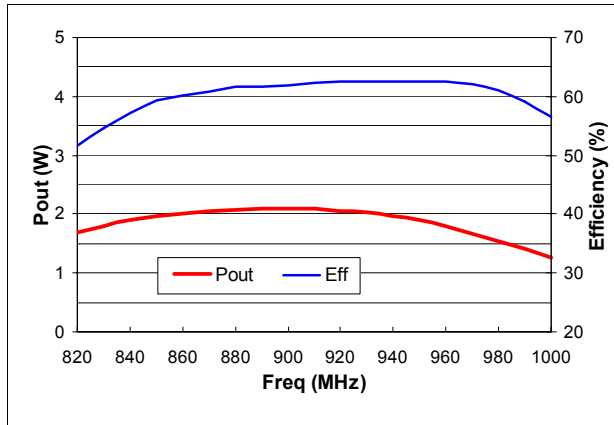

Figure 8. Gain vs frequency 7.2 V - 100 mA

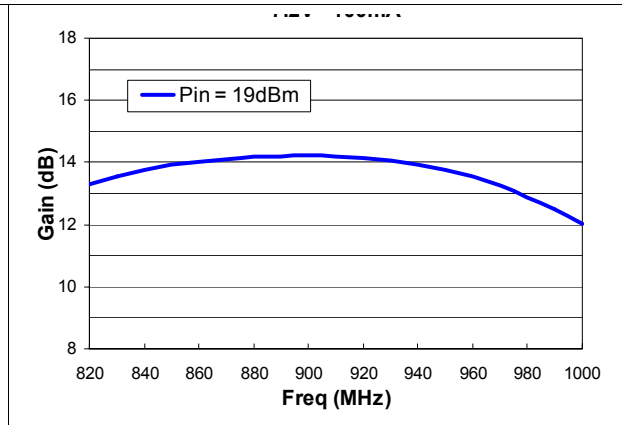

Figure 9. Input return loss vs frequency 7.2 V / 100 mA

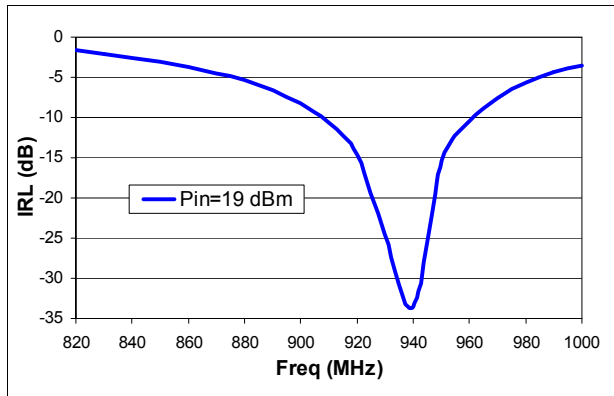

Figure 10. Harmonics vs frequency 7.2 V / 100 mA

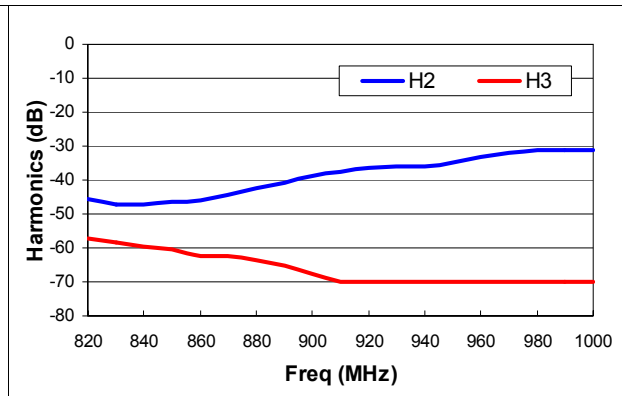
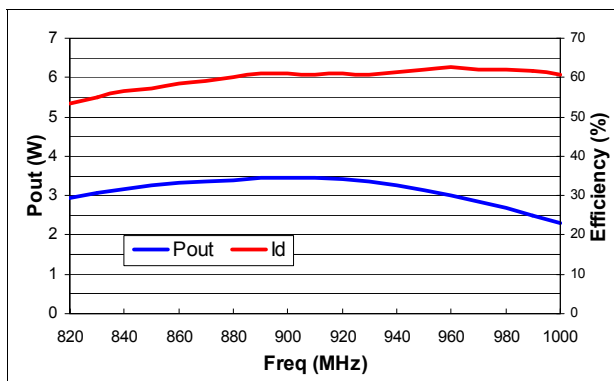

Figure 11. Output power and efficiency vs frequency 9 V / 100 mA / Pin = 22 dBm



6 Schematic and BOM

Figure 12. Schematic

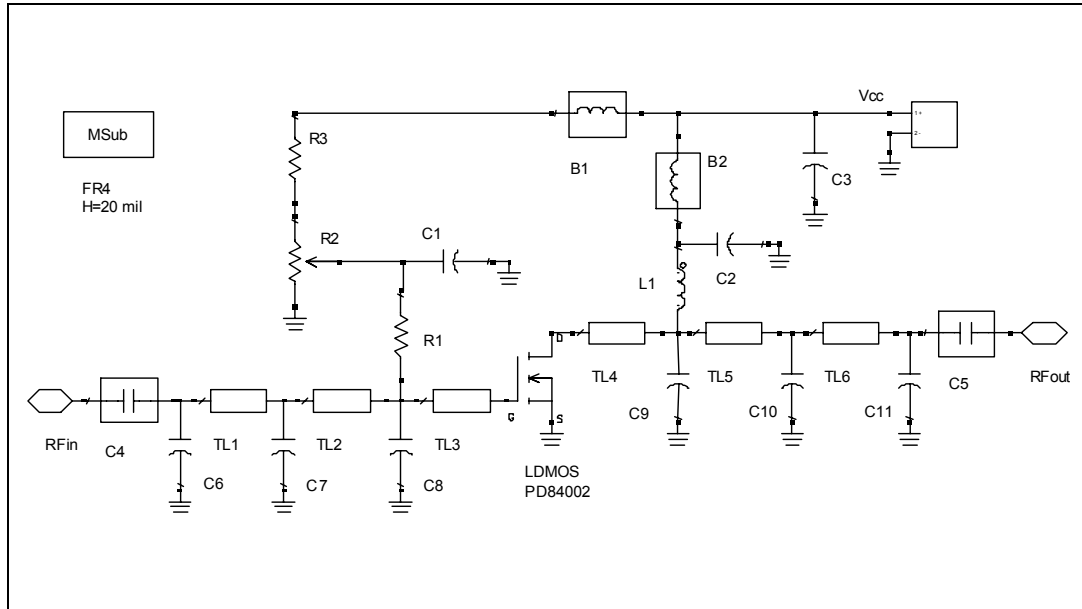

Table 8. Components part list

Component ID	Description	Value	Case size	Manufacturer	Part Code
B1	Ferrite Bead			Panasonic	EXCELDR35C
B2	Ferrite Bead			Panasonic	EXCELDR35C
C1, C2	Capacitor	120 pF	0603	Murata	GRM39-C0G121J50D500
C3	Capacitor	1 uF	0603	Murata	GRM39-X5R105K16D52K
C4, C5	Capacitor	39 pF	0603	Murata	GRM39-C0G390J50D500
C6, C10	Capacitor	3.3 pF	0603	Murata	GRM39-C0G3R3C50Z500
C7	Capacitor	8.2 pF	0603	Murata	GRM39-C0G8R2D50Z500
C8	Capacitor	22 pF	0603	Murata	GRM39-C0G220J50D500
C9	Capacitor	12 pF	0603	Murata	GRM39-C0G120J50D500
C11	Capacitor	2.7 pF	0603	Murata	GRM39-C0G2R7C50Z500
L1	Inductor	12.55 nH		Coilcraft	1606-10
R1	Resistor	150 Ω	0603	Tyco electronics	
R2	Potentiometer	10 KΩ		Bourns electronics	3214W-1-103E
R3	Resistor	1 K	0603	Tyco electronics	01623440-1

Table 8. Components part list (continued)

Component ID	Description	Value	Case size	Manufacturer	Part Code
TL1	Transmission line	W=0.92 mm	L=13.6 mm		
TL2	Transmission line	W=0.92 mm	L=3.5 mm		
TL3	Transmission line	W=0.92 mm	L=4.2 mm		
TL4	Transmission line	W=0.92 mm	L=3.8 mm		
TL5	Transmission line	W=0.92 mm	L=3.7 mm		
TL6	Transmission line	W=0.92 mm	L=11.3 mm		
RF in, RF out	SMA-CONN	50 Ω	60 mils	JOHNSON	142-0701-801
PD84002	LDMOS			STMicroelectronics	PD84002
Board	FR-4 THk=0.020" 2OZ Cu Both Sides				

7 Photo

Figure 13. Photo

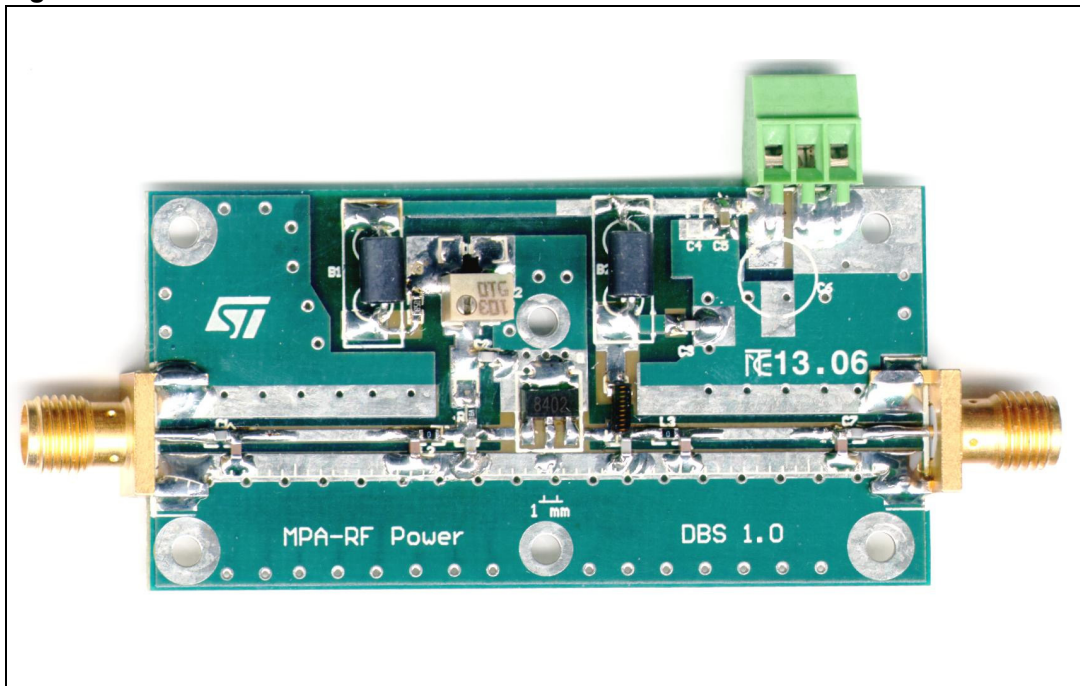

8 Package mechanical data

In order to meet environmental requirements, ST offers these devices in ECOPACK® packages. These packages have a Lead-free second level interconnect . The category of second level interconnect is marked on the package and on the inner box label, in compliance with JEDEC Standard JESD97. The maximum ratings related to soldering conditions are also marked on the inner box label. ECOPACK is an ST trademark. ECOPACK specifications are available at: www.st.com

Table 9. SOT-89 mechanical data

Dim.	mm.			Inch		
	Min	Typ	Max	Min	Typ	Max
A	1.4		1.6	55.1		63.0
B	0.44		0.56	17.3		22.0
B1	0.36		0.48	14.2		18.9
C	0.35		0.44	13.8		17.3
C1	0.35		0.44	13.8		17.3
D	4.4		4.6	173.2		181.1
D1	1.62		1.83	63.8		72.0
E	2.29		2.6	90.2		102.4
e	1.42		1.57	55.9		61.8
e1	2.92		3.07	115.0		120.9
H	3.94		4.25	155.1		167.3
L	0.89		1.2	35.0		47.2

Figure 14. Package dimensions

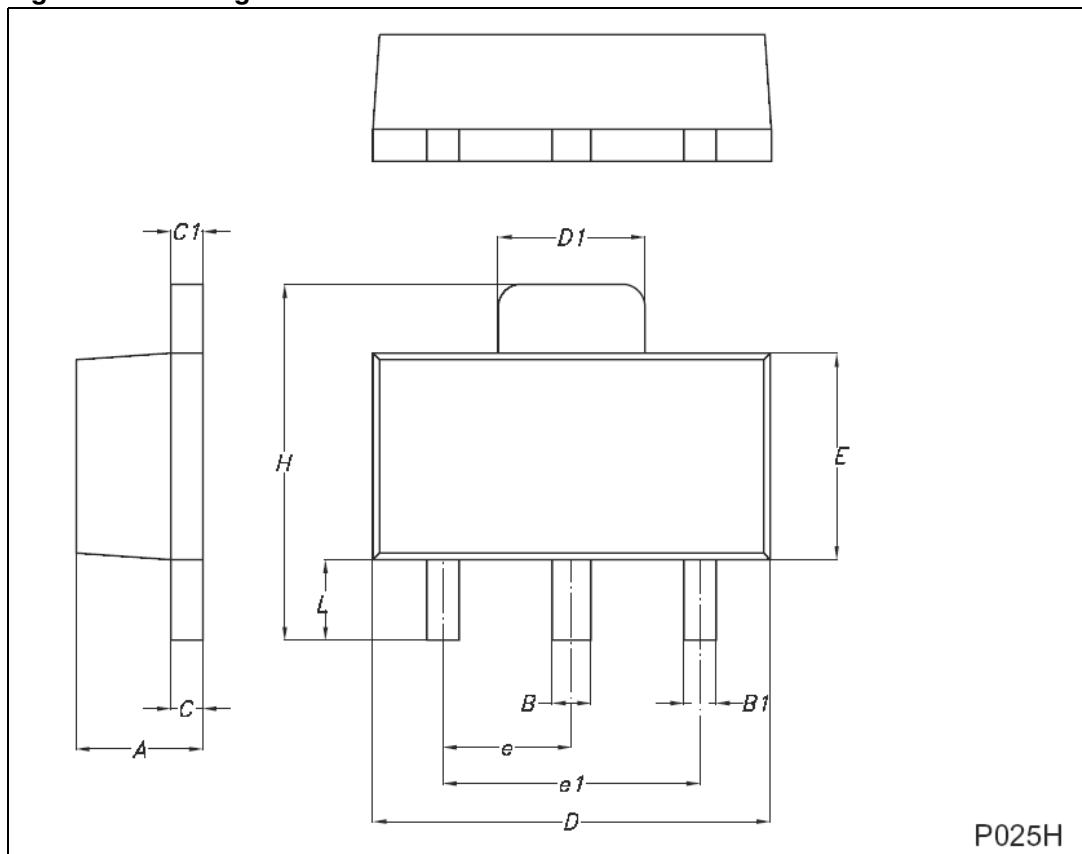

P025H

8.1 Thermal pad and via design

Thermal vias are required in the PCB layout to effectively conduct heat away from the package. The via pattern has been designed to address thermal, power dissipation and electrical requirements of the device.

The via pattern is based on thru-hole vias with 0.203mm to 0.330mm finished hole size on a 0.5mm to 1.2mm grid pattern with 0.025 plating on via walls. If micro vias are used in a design, it is suggested that the quantity of vias be increased by a 4:1 ratio to achieve similar results.

Figure 15. Pad layout details

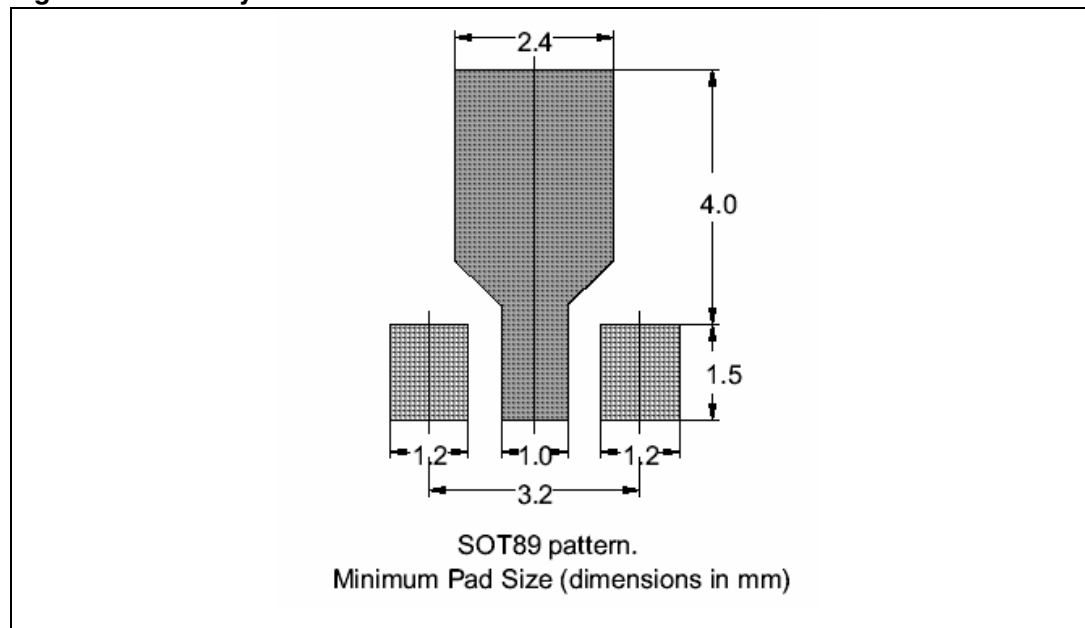

8.2 Soldering profile

Figure 16 shows the recommended solder for devices that have Pb-free terminal plating and where a Pb-free solder is used.

Figure 16. Recommended solder profile

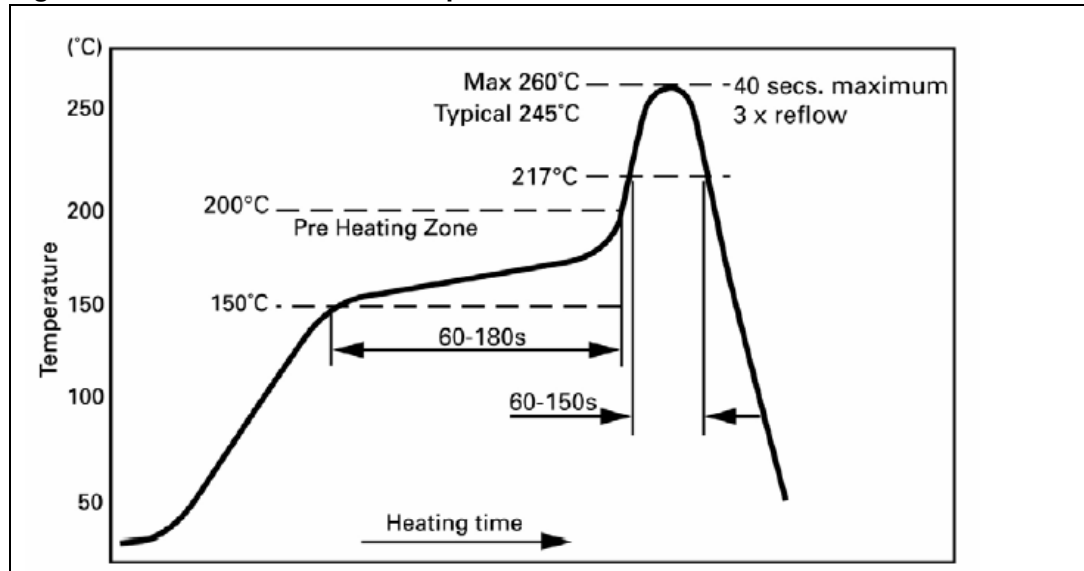
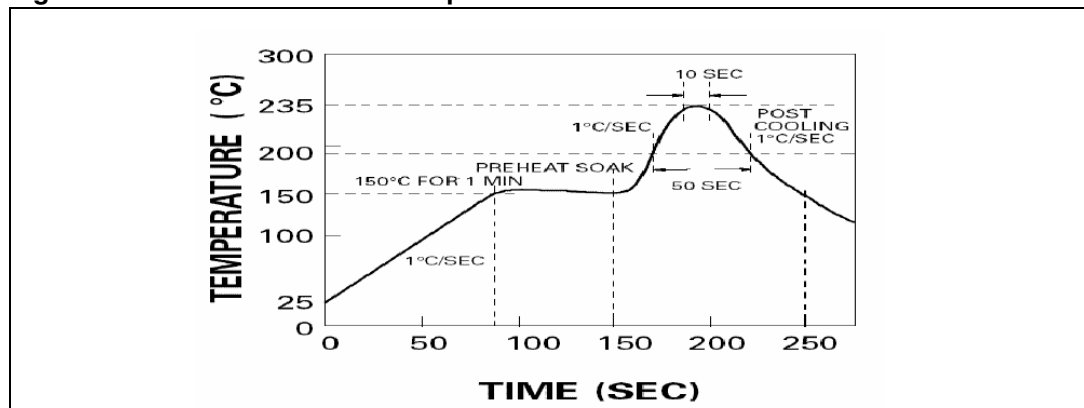

Figure 17 shows the recommended solder for devices with Pb-free terminal plating used with leaded solder, or for devices with leaded terminal plating used with a leaded solder.

Figure 17. Recommended solder profile for leaded devices



9 Revision history

Table 10. Document revision history

Date	Revision	Changes
05-Dec-2007	1	Initial release.

Please Read Carefully:

Information in this document is provided solely in connection with ST products. STMicroelectronics NV and its subsidiaries ("ST") reserve the right to make changes, corrections, modifications or improvements, to this document, and the products and services described herein at any time, without notice.

All ST products are sold pursuant to ST's terms and conditions of sale.

Purchasers are solely responsible for the choice, selection and use of the ST products and services described herein, and ST assumes no liability whatsoever relating to the choice, selection or use of the ST products and services described herein.

No license, express or implied, by estoppel or otherwise, to any intellectual property rights is granted under this document. If any part of this document refers to any third party products or services it shall not be deemed a license grant by ST for the use of such third party products or services, or any intellectual property contained therein or considered as a warranty covering the use in any manner whatsoever of such third party products or services or any intellectual property contained therein.

UNLESS OTHERWISE SET FORTH IN ST'S TERMS AND CONDITIONS OF SALE ST DISCLAIMS ANY EXPRESS OR IMPLIED WARRANTY WITH RESPECT TO THE USE AND/OR SALE OF ST PRODUCTS INCLUDING WITHOUT LIMITATION IMPLIED WARRANTIES OF MERCHANTABILITY, FITNESS FOR A PARTICULAR PURPOSE (AND THEIR EQUIVALENTS UNDER THE LAWS OF ANY JURISDICTION), OR INFRINGEMENT OF ANY PATENT, COPYRIGHT OR OTHER INTELLECTUAL PROPERTY RIGHT.

UNLESS EXPRESSLY APPROVED IN WRITING BY AN AUTHORIZED ST REPRESENTATIVE, ST PRODUCTS ARE NOT RECOMMENDED, AUTHORIZED OR WARRANTED FOR USE IN MILITARY, AIR CRAFT, SPACE, LIFE SAVING, OR LIFE SUSTAINING APPLICATIONS, NOR IN PRODUCTS OR SYSTEMS WHERE FAILURE OR MALFUNCTION MAY RESULT IN PERSONAL INJURY, DEATH, OR SEVERE PROPERTY OR ENVIRONMENTAL DAMAGE. ST PRODUCTS WHICH ARE NOT SPECIFIED AS "AUTOMOTIVE GRADE" MAY ONLY BE USED IN AUTOMOTIVE APPLICATIONS AT USER'S OWN RISK.

Resale of ST products with provisions different from the statements and/or technical features set forth in this document shall immediately void any warranty granted by ST for the ST product or service described herein and shall not create or extend in any manner whatsoever, any liability of ST.

ST and the ST logo are trademarks or registered trademarks of ST in various countries.

Information in this document supersedes and replaces all information previously supplied.

The ST logo is a registered trademark of STMicroelectronics. All other names are the property of their respective owners.

© 2007 STMicroelectronics - All rights reserved

STMicroelectronics group of companies

Australia - Belgium - Brazil - Canada - China - Czech Republic - Finland - France - Germany - Hong Kong - India - Israel - Italy - Japan - Malaysia - Malta - Morocco - Singapore - Spain - Sweden - Switzerland - United Kingdom - United States of America

www.st.com

Компания «Океан Электроники» предлагает заключение долгосрочных отношений при поставках импортных электронных компонентов на взаимовыгодных условиях!

Наши преимущества:

- Поставка оригинальных импортных электронных компонентов напрямую с производств Америки, Европы и Азии, а так же с крупнейших складов мира;
- Широкая линейка поставок активных и пассивных импортных электронных компонентов (более 30 млн. наименований);
- Поставка сложных, дефицитных, либо снятых с производства позиций;
- Оперативные сроки поставки под заказ (от 5 рабочих дней);
- Экспресс доставка в любую точку России;
- Помощь Конструкторского Отдела и консультации квалифицированных инженеров;
- Техническая поддержка проекта, помощь в подборе аналогов, поставка прототипов;
- Поставка электронных компонентов под контролем ВП;
- Система менеджмента качества сертифицирована по Международному стандарту ISO 9001;
- При необходимости вся продукция военного и аэрокосмического назначения проходит испытания и сертификацию в лаборатории (по согласованию с заказчиком);
- Поставка специализированных компонентов военного и аэрокосмического уровня качества (Xilinx, Altera, Analog Devices, Intersil, Interpoint, Microsemi, Actel, Aeroflex, Peregrine, VPT, Syfer, Eurofarad, Texas Instruments, MS Kennedy, Miteq, Cobham, E2V, MA-COM, Hittite, Mini-Circuits, General Dynamics и др.);

Компания «Океан Электроники» является официальным дистрибьютором и эксклюзивным представителем в России одного из крупнейших производителей разъемов военного и аэрокосмического назначения «**JONHON**», а так же официальным дистрибьютором и эксклюзивным представителем в России производителя высокотехнологичных и надежных решений для передачи СВЧ сигналов «**FORSTAR**».



JONHON

«**JONHON**» (основан в 1970 г.)

Разъемы специального, военного и аэрокосмического назначения:

(Применяются в военной, авиационной, аэрокосмической, морской, железнодорожной, горно- и нефтедобывающей отраслях промышленности)

«**FORSTAR**» (основан в 1998 г.)

ВЧ соединители, коаксиальные кабели, кабельные сборки и микроволновые компоненты:

(Применяются в телекоммуникациях гражданского и специального назначения, в средствах связи, РЛС, а так же военной, авиационной и аэрокосмической отраслях промышленности).



Телефон: 8 (812) 309-75-97 (многоканальный)

Факс: 8 (812) 320-03-32

Электронная почта: ocean@oceanchips.ru

Web: <http://oceanchips.ru/>

Адрес: 198099, г. Санкт-Петербург, ул. Калинина, д. 2, корп. 4, лит. А