

24-Bit, 192 kHz Stereo DAC with Volume Control

Features

- Complete Stereo DAC System: Interpolation, D/A, Output Analog Filtering
- 114 dB Dynamic Range
- 100 dB THD+N
- Up to 192kHz Sample Rates
- Direct Stream Digital Mode
- Low Clock Jitter Sensitivity
- Single +5 V Power Supply
- Selectable Digital Filters
 - Fast and Slow roll-off
- Volume Control with Soft Ramp
 - 1 dB Step Size
 - Zero Crossing Click-Free Transitions
- Direct Interface with 5 V to 1.8 V Logic
- ATAPI Mixing Functions
- Pin Compatible with the CS4391

Description

The CS4392 is a complete stereo digital-to-analog system including digital interpolation, fifth-order delta-sigma digital-to-analog conversion, digital de-emphasis, volume control, channel mixing and analog filtering. The advantages of this architecture include: ideal differential linearity, no distortion mechanisms due to resistor matching errors, no linearity drift over time and temperature, and a high tolerance to clock jitter.

The CS4392 accepts PCM data at sample rates from 4 kHz to 192 kHz, DSD audio data, has selectable digital filters, and consumes very little power. These features are ideal for DVD, SACD players, A/V receivers, CD and set-top box systems. The CS4392 is pin and register compatible with the CS4391, making easy performance upgrades possible.

ORDERING INFORMATION

| | |
|-----------------------|--------------------------|
| CS4392-KS | -10 to 70 °C 20-pin SOIC |
| CS4392-KZ | -10 to 70 °C 20-pinTSSOP |
| CS4392-KZZ, Lead Free | -10 to 70 °C 20-pinTSSOP |
| CDB4392 | Evaluation Board |

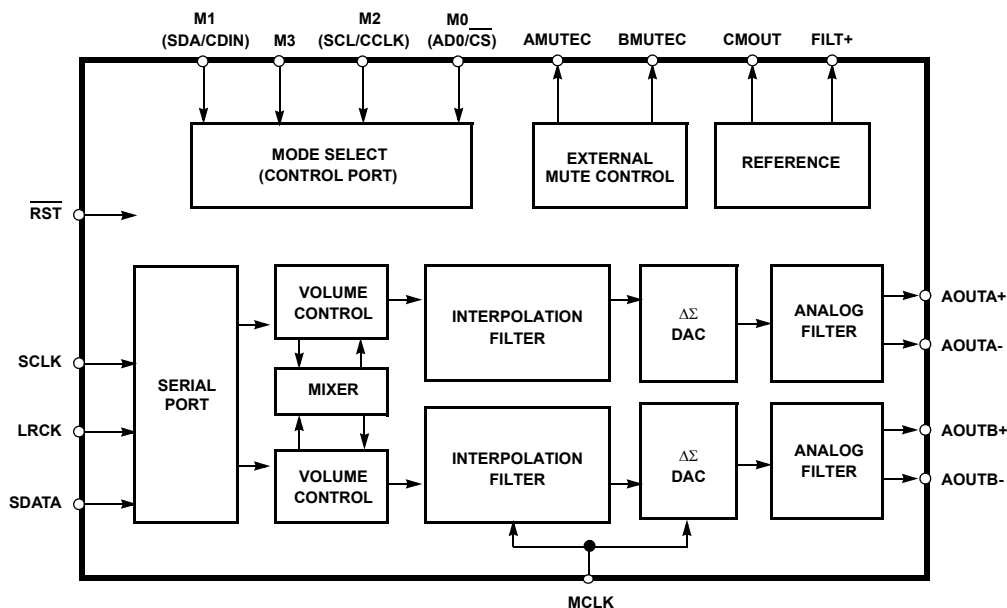

Preliminary Product Information

This document contains information for a new product. Cirrus Logic reserves the right to modify this product without notice.

TABLE OF CONTENTS

| | |
|--|-----------|
| 1. PIN DESCRIPTION - PCM DATA MODE | 5 |
| 1.1 PIN DESCRIPTION - DSD mode | 6 |
| 2. TYPICAL CONNECTION DIAGRAMS | 7 |
| 3. APPLICATIONS | 9 |
| 3.1 Recommended Power-up Sequence for Hardware Mode | 9 |
| 3.2 Recommended Power-up Sequence and Access to Control Port Mode | 9 |
| 3.3 Analog Output and Filtering | 9 |
| 3.4 Interpolation Filter | 10 |
| 3.5 System Clocking | 10 |
| 3.6 Digital Interface Format | 11 |
| 3.7 De-Emphasis | 12 |
| 3.8 Oversampling Modes | 12 |
| 3.9 Using DSD mode | 13 |
| 3.10 Mute Control | 13 |
| 4. CONTROL PORT INTERFACE | 14 |
| 4.0.1 MAP Auto Increment | 14 |
| 4.0.2 I2C Mode | 14 |
| I2C Write | 14 |
| I2C Read | 15 |
| 4.0.3 SPI Mode | 16 |
| SPI Write | 16 |
| 4.1 Memory Address Pointer (MAP) | 16 |
| 5. REGISTER QUICK REFERENCE | 17 |
| 6. REGISTER DESCRIPTION | 18 |
| 6.1 Mode Control 1 - Address 01h | 18 |
| 6.1.1 Auto-Mute (Bit 7) | 18 |
| 6.1.2 Digital Interface Formats (Bits 6:4) | 18 |
| 6.1.3 De-Emphasis Control (Bits 3:2) | 19 |
| 6.1.4 Functional Mode (Bits 1:0) | 19 |
| 6.2 Volume and Mixing Control (Address 02h) | 20 |
| 6.2.1 Channel A Volume = Channel B Volume (Bit 7) | 20 |

Contacting Cirrus Logic Support

For all product questions and inquiries contact a Cirrus Logic Sales Representative.

To find one nearest you go to <http://www.cirrus.com/corporate/contacts/sales.cfm>

IMPORTANT NOTICE

"Preliminary" product information describes products that are in production, but for which full characterization data is not yet available. "Advance" product information describes products that are in development and subject to development changes. Cirrus Logic, Inc. and its subsidiaries ("Cirrus") believe that the information contained in this document is accurate and reliable. However, the information is subject to change without notice and is provided "AS IS" without warranty of any kind (express or implied). Customers are advised to obtain the latest version of relevant information to verify, before placing orders, that information being relied on is current and complete. All products are sold subject to the terms and conditions of sale supplied at the time of order acknowledgment, including those pertaining to warranty, patent infringement, and limitation of liability. No responsibility is assumed by Cirrus for the use of this information, including use of this information as the basis for manufacture or sale of any items, or for infringement of patents or other rights of third parties. This document is the property of Cirrus and by furnishing this information, Cirrus grants no license, express or implied under any patents, mask work rights, copyrights, trademarks, trade secrets or other intellectual property rights. Cirrus owns the copyrights of the information contained herein and gives consent for copies to be made of the information only for use within your organization with respect to Cirrus integrated circuits or other parts of Cirrus. This consent does not extend to other copying such as copying for general distribution, advertising or promotional purposes, or for creating any work for resale.

An export permit needs to be obtained from the competent authorities of the Japanese Government if any of the products or technologies described in this material and controlled under the "Foreign Exchange and Foreign Trade Law" is to be exported or taken out of Japan. An export license and/or quota needs to be obtained from the competent authorities of the Chinese Government if any of the products or technologies described in this material is subject to the PRC Foreign Trade Law and is to be exported or taken out of the PRC.

CERTAIN APPLICATIONS USING SEMICONDUCTOR PRODUCTS MAY INVOLVE POTENTIAL RISKS OF DEATH, PERSONAL INJURY, OR SEVERE PROPERTY OR ENVIRONMENTAL DAMAGE ("CRITICAL APPLICATIONS"). CIRRUS PRODUCTS ARE NOT DESIGNED, AUTHORIZED, OR WARRANTED TO BE SUITABLE FOR USE IN LIFE-SUPPORT DEVICES OR SYSTEMS OR OTHER CRITICAL APPLICATIONS. INCLUSION OF CIRRUS PRODUCTS IN SUCH APPLICATIONS IS UNDERSTOOD TO BE FULLY AT THE CUSTOMER'S RISK.

Cirrus Logic, Cirrus, and the Cirrus Logic logo designs are trademarks of Cirrus Logic, Inc. All other brand and product names in this document may be trademarks or service marks of their respective owners.

| | | |
|------------|---|-----------|
| 6.2.2 | Soft Ramp or Zero Cross Enable (Bits 6:5) | 20 |
| 6.2.3 | ATAPI Channel Mixing and Muting (Bits 4:0) | 20 |
| 6.3 | Channel A Volume Control - Address 03h | 22 |
| 6.4.1 | Mute (Bit 7) | 22 |
| 6.4.2 | Volume Control (Bits 6:0) | 22 |
| 6.5 | Mode Control 2 - Address 05h | 22 |
| 6.5.1 | Invert Signal Polarity (Bits 7:6) | 22 |
| 6.5.2 | Control Port Enable (Bit 5) | 23 |
| 6.5.3 | Power Down (Bit 4) | 23 |
| 6.5.4 | AMUTEC = BMUTEC (Bit 3) | 23 |
| 6.5.5 | Freeze (Bit 2) | 23 |
| 6.5.6 | Master Clock Divide (Bit 1) | 23 |
| 6.6 | Mode Control 3 - Address 06h | 23 |
| 6.6.1 | Interpolation Filter Select (Bit 4) | 23 |
| 6.6.2 | Soft Volume Ramp-up after Reset (Bit 3) | 24 |
| 6.6.3 | Soft Ramp-down before Reset (Bit 2) | 24 |
| 6.7 | Chip ID - Register 07h | 24 |
| 7. | CHARACTERISTICS/SPECIFICATIONS | 25 |
| | ANALOG CHARACTERISTICS (CS4392-KS/KZ/KZZ) | 25 |
| | COMBINED INTERPOLATION & ON-CHIP ANALOG FILTER RESPONSE | 26 |
| | SWITCHING CHARACTERISTICS - SERIAL AUDIO INTERFACE | 32 |
| | SWITCHING SPECIFICATIONS - DSD INTERFACE | 33 |
| | SWITCHING CHARACTERISTICS - CONTROL PORT INTERFACE | 34 |
| | SWITCHING CHARACTERISTICS - SPI CONTROL PORT | 35 |
| | DC ELECTRICAL CHARACTERISTICS | 36 |
| | DIGITAL INPUT CHARACTERISTICS & SPECIFICATIONS | 36 |
| | RECOMMENDED OPERATING SPECIFICATIONS | 37 |
| | ABSOLUTE MAXIMUM RATINGS | 37 |
| 8. | PARAMETER DEFINITIONS | 38 |
| 9. | REFERENCES | 38 |
| 10. | PACKAGE DIMENSIONS | 39 |

LIST OF TABLES

| | | |
|-----------|--|----|
| Table 1. | Clock Ratios | 10 |
| Table 2. | Single Speed (4 to 50 kHz sample rates) Common Clock Frequencies | 10 |
| Table 3. | Double Speed (50 to 100 kHz sample rates) Common Clock Frequencies | 10 |
| Table 4. | Quad Speed (100 to 200 kHz sample rates) Common Clock Frequencies | 10 |
| Table 5. | Digital Interface Format, Stand-Alone Mode Options | 11 |
| Table 5. | De-Emphasis Select, Stand-Alone Mode | 12 |
| Table 6. | Mode Selection, Stand-Alone Mode Options | 12 |
| Table 7. | Direct Stream Digital (DSD), Stand-Alone Mode Options | 13 |
| Table 8. | Digital Interface Formats - PCM Modes | 18 |
| Table 10. | De-Emphasis Mode Selection | 19 |
| Table 11. | Functional Mode Selection | 19 |
| Table 12. | Soft Cross or Zero Cross Mode Selection | 20 |
| Table 13. | ATAPI Decode | 21 |
| Table 14. | Digital Volume Control Example Settings | 22 |

LIST OF FIGURES

| | |
|---|----|
| Figure 1. Typical Connection Diagram - PCM Mode | 7 |
| Figure 2. Typical Connection Diagram - DSD Mode | 8 |
| Figure 3. CS4392 Output Filter | 9 |
| Figure 4. Format 0, Left Justified up to 24-Bit Data | 11 |
| Figure 5. Format 1, I2S up to 24-Bit Data | 11 |
| Figure 6. Format 2, Right Justified 16-Bit Data | |
| Format 3, Right Justified 24-Bit Data | |
| Format 4, Right Justified 20-Bit Data. (Available in Control Port Mode only) | |
| Format 5, Right Justified 18-Bit Data. (Available in Control Port Mode only)..... | 11 |
| Figure 7. De-Emphasis Curve | 12 |
| Figure 8. Control Port Timing, I2C Mode..... | 15 |
| Figure 9. Control Port Timing, SPI mode | 16 |
| Figure 10. De-Emphasis Curve | 19 |
| Figure 11. ATAPI Block Diagram | 21 |
| Figure 12. Single Speed (fast) Stopband Rejection | 28 |
| Figure 13. Single Speed (fast) Transition Band | 28 |
| Figure 14. Single Speed (fast) Transition Band (detail) | 28 |
| Figure 15. Single Speed (fast) Passband Ripple | 28 |
| Figure 16. Single Speed (slow) Stopband Rejection..... | 28 |
| Figure 17. Single Speed (slow) Transition Band..... | 28 |
| Figure 18. Single Speed (slow) Transition Band (detail)..... | 29 |
| Figure 19. Single Speed (slow) Passband Ripple | 29 |
| Figure 20. Double Speed (fast) Stopband Rejection..... | 29 |
| Figure 21. Double Speed (fast) Transition Band..... | 29 |
| Figure 22. Double Speed (fast) Transition Band (detail)..... | 29 |
| Figure 23. Double Speed (fast) Passband Ripple | 29 |
| Figure 24. Double Speed (slow) Stopband Rejection | 30 |
| Figure 25. Double Speed (slow) Transition Band..... | 30 |
| Figure 26. Double Speed (slow) Transition Band (detail)..... | 30 |
| Figure 27. Double Speed (slow) Passband Ripple..... | 30 |
| Figure 28. Quad Speed (fast) Stopband Rejection | 30 |
| Figure 29. Quad Speed (fast) Transition Band..... | 30 |
| Figure 30. Quad Speed (fast) Transition Band (detail)..... | 31 |
| Figure 31. Quad Speed (fast) Passband Ripple..... | 31 |
| Figure 32. Quad Speed (slow) Stopband Rejection | 31 |
| Figure 33. Quad Speed (slow) Transition Band | 31 |
| Figure 34. Quad Speed (slow) Transition Band (detail) | 31 |
| Figure 35. Quad Speed (slow) Passband Ripple | 31 |
| Figure 36. Serial Mode Input Timing | 32 |
| Figure 37. Direct Stream Digital - Serial Audio Input Timing..... | 33 |
| Figure 38. I2C Mode Control Port Timing..... | 34 |
| Figure 39. SPI Control Port Timing | 35 |

1. PIN DESCRIPTION - PCM DATA MODE

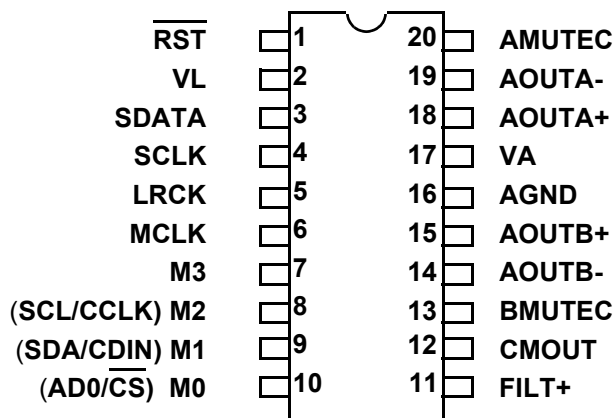

| | | |
|--------------------------------------|----|--|
| $\overline{\text{RST}}$ | 1 | Reset (Input) - Powers down device and resets all internal registers to their default settings. |
| VL | 2 | Logic Power (Input) - Positive power for the digital input/output. |
| SDATA | 3 | Serial Audio Data (Input) - Input for two's complement serial audio data. |
| SCLK | 4 | Serial Clock (Input/Output) - Serial clock for the serial audio interface. |
| LRCK | 5 | Left Right Clock (Input/Output) - Determines which channel, Left or Right, is currently active on the serial audio data line. |
| MCLK | 6 | Master Clock (Input) - Clock source for the delta-sigma modulator and digital filters. |
| FILT+ | 11 | Positive Voltage Reference (Output) - Positive reference voltage for the internal sampling circuits. |
| CMOUT | 12 | Common Mode Voltage (Output) - Filter connection for internal quiescent voltage. |
| AMUTEC | 20 | Mute Control (Output) - The Mute Control pin goes high during power-up initialization, reset, muting, power-down or if the master clock to left/right clock frequency ratio is incorrect. |
| BMUTEC | 13 | |
| AOUTB- | 14 | Differential Analog Output (Outputs) - The full scale differential analog output level is specified in the Analog Characteristics specification table. |
| AOUTB+ | 15 | |
| AOUTA+ | 18 | |
| AOUTA | 19 | |
| AGND | 16 | Ground (Input) |
| VA | 17 | Analog Power (Input) - Positive power for the analog section. |
| Control Port Mode Definitions | | |
| M3 | 7 | Mode Selection (Input) - This pins should be tied to GND level during control port mode. |
| SCL/CCLK | 8 | Serial Control Port Clock (Input) - Serial clock for the serial control port. |
| SDA/CDIN | 9 | Serial Control Data (Input/Output) - SDA is a data I/O line in I ² C mode. CDIN is the input data line for the control port interface in SPI mode. |
| AD0/ $\overline{\text{CS}}$ | 10 | Address Bit 0 (I²C) / Control Port Chip Select (SPI) (Input/Output) - AD0 is a chip address pin in I ² C mode; CS is the chip select signal for SPI format. |
| Stand-Alone Mode Definitions | | |
| M3 | 7 | Mode Selection (Input) - Determines the operational mode of the device. |
| M2 | 8 | |
| M1 | 9 | |
| M0 | 10 | |

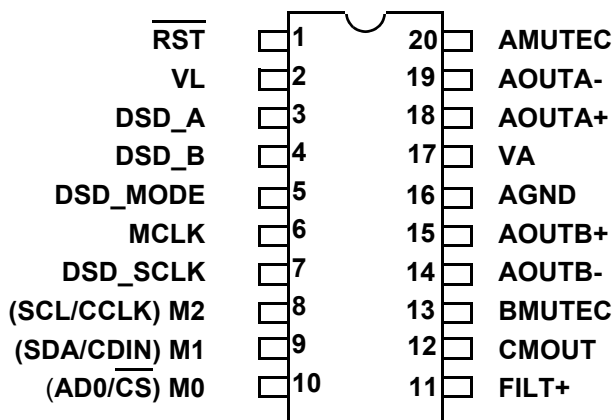
1.1 PIN DESCRIPTION - DSD mode

| | | |
|-----------------|---|---|
| DSD_A | 3 | DSD Data (Input) - Input for Direct Stream Digital serial audio data. |
| DSD_B | 4 | |
| DSD_Mode | 5 | DSD Mode (Input) - In stand alone mode, this pin must be set to a logic '1' for operation of DSD Mode. |
| DSD_SCLK | 7 | DSD Serial Clock (Input/Output) - Serial clock for the Direct Stream Digital audio interface. |

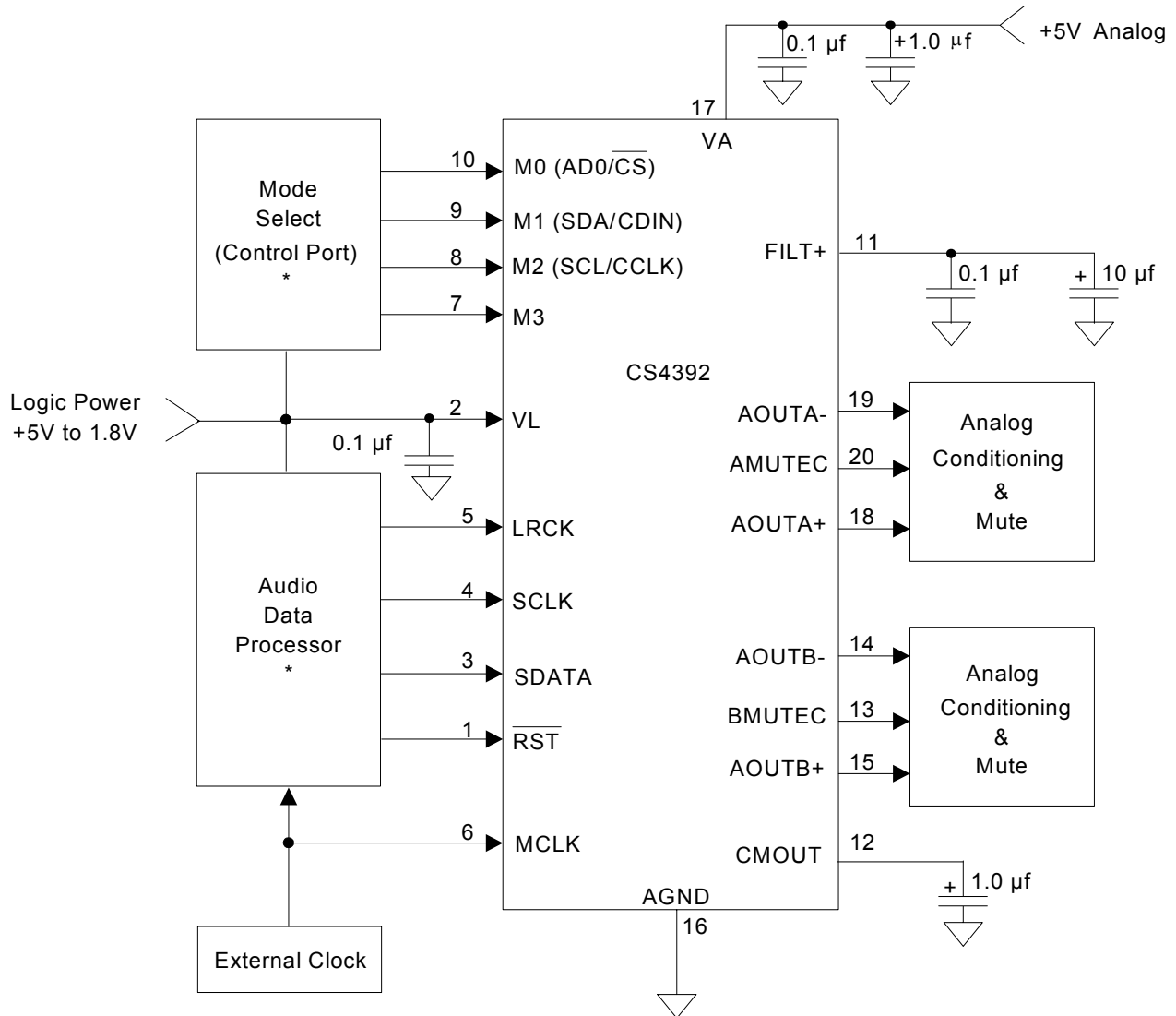
2. TYPICAL CONNECTION DIAGRAMS

Figure 1. Typical Connection Diagram - PCM Mode

* A high logic level for all digital inputs should not exceed VL.

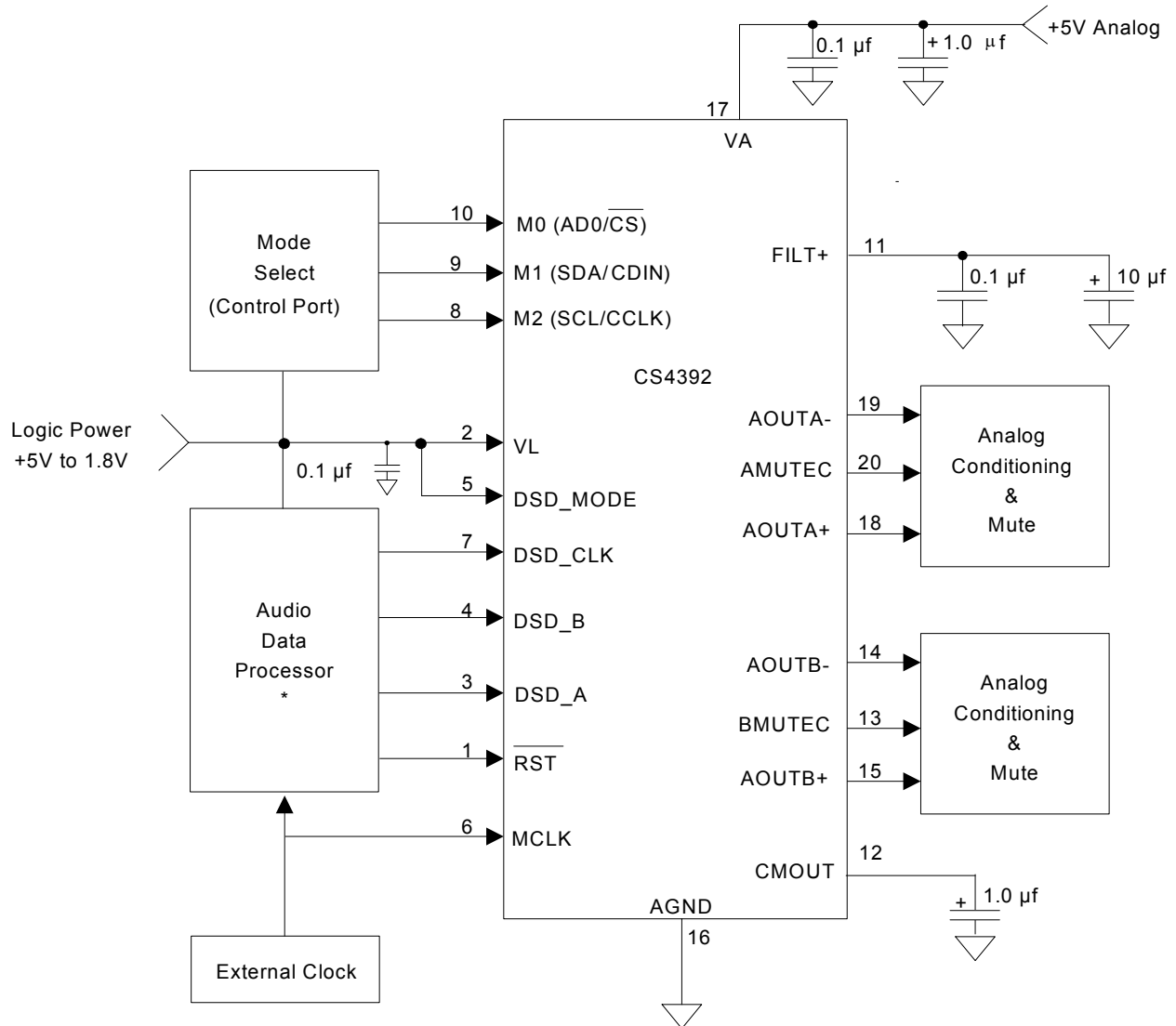

Figure 2. Typical Connection Diagram - DSD Mode
 * A high logic level for all digital inputs should not exceed VL.

3. APPLICATIONS

3.1 Recommended Power-up Sequence for Hardware Mode

- 1) Hold $\overline{\text{RST}}$ low until the power supplies, master, and left/right clocks are stable.
- 2) Bring $\overline{\text{RST}}$ high. After 10ms the device will begin normal operation.

3.2 Recommended Power-up Sequence and Access to Control Port Mode

- 1) Hold $\overline{\text{RST}}$ low until the power supply, master, and left/right clocks are stable. In this state, the control port is reset to its default settings and FILT+ will remain low.
- 2) Bring $\overline{\text{RST}}$ high. The device will remain in a low power state with FILT+ low and the control port is accessible.
- 3) Write 30h to register 05h within 10 ms cycles following the release of $\overline{\text{RST}}$. If after 10ms the control port has not been initiated with this command, the device will enter stand-alone mode. The CPEN bit, however, may be written at any time after 10ms. It is recommended to write CPEN before 10ms in order to reduce the possibility of any extraneous click or pop noise from occurring.
- 4) The desired register settings can be loaded while keeping the PDN bit set to 1.
- 5) Set the PDN bit to 0. This will initiate the power-up sequence which requires approximately 10 μS .

3.3 Analog Output and Filtering

The application note “Design Notes for a 2-Pole Filter with Differential Input” discusses the second-order Butterworth filter and differential to single-ended converter as seen in Figure 3. An alternate configuration can be seen on the CDB4392. This alternate filter configuration accounts for the differing AC loads on the + and - differential output pins which are normally present in a circuit like Figure 3. It also shows an AC coupling configuration which reduces the number of required AC coupling capacitors to 2 caps per channel. The circuit in figure 3 may also be DC coupled, however the filter on the CDB4392 must be AC coupled. The CS4392 is a linear phase design and does not include phase or amplitude compensation for an external filter. Therefore, the DAC system phase and amplitude response will be dependent on the external analog circuitry.

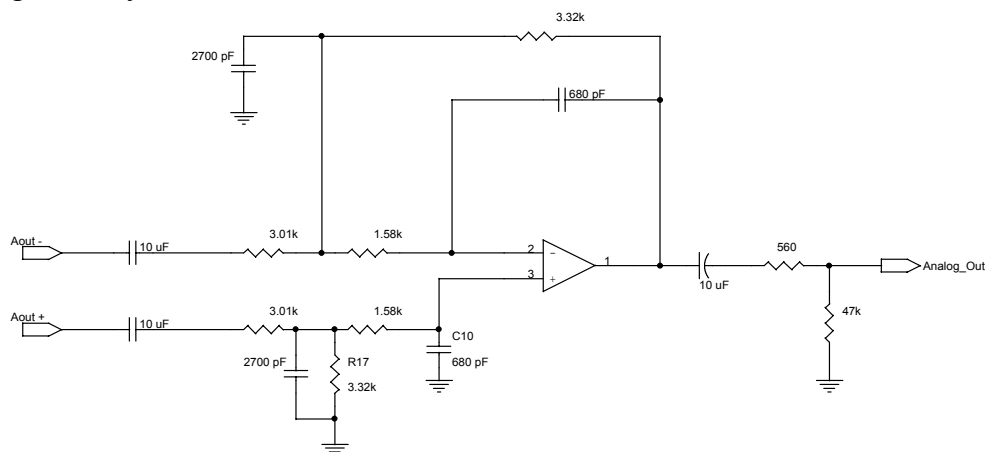

Figure 3. CS4392 Output Filter

3.4 Interpolation Filter

To accommodate the increasingly complex requirements of digital audio systems, the CS4392 incorporates selectable interpolation filters for each mode of operation. A fast and a slow roll-off filter is available in each of Single, Double, and Quad Speed modes. These filters have been designed to accommodate a variety of musical tastes and styles. Bit 5 of the Mode Control 3 register (06h) is used to select which filter is used. Filter specifications can be found in Section 8, and filter response plots can be found in Figures 12 to 35.

In stand-alone mode, only the fast roll-off filter is available.

3.5 System Clocking

The required MCLK to LRCK and suggested SCLK to LRCK ratios are outlined in table 1. MCLK can be at any phase in regards to LRCK and SCLK. SCLK, LRCK and SDATA must meet the phase and timing relationships outlined in Section 7. Some common MCLK frequencies have been outlined in tables 2 to 4.

| | MCLK/LRCK | SCLK/LRCK | LRCK |
|---------------------|---------------------------|---------------------|-------------|
| Single Speed | 256, 384, 512, 768, 1024* | 32, 48, 64, 96, 128 | Fs |
| Double Speed | 128, 192, 256, 384, 512* | 32, 48, 64 | Fs |
| Quad Speed | 64 | 32 (16 bits only) | Fs |
| | 96 | 32, 48 | Fs |
| | 128, 256* | 32, 64 | Fs |
| | 192 | 32, 48, 64, 96 | Fs |

Table 1. Clock Ratios

| Sample Rate (kHz) | MCLK (MHz) | | | | See Note |
|--------------------------|-------------------|-------------|-------------|-------------|-----------------|
| | 256x | 384x | 512x | 768x | |
| 32 | 8.1920 | 12.2880 | 16.3840 | 24.5760 | 32.7680 |
| 44.1 | 11.2896 | 16.9344 | 22.5792 | 33.8688 | 45.1584 |
| 48 | 12.2880 | 18.4320 | 24.5760 | 36.8640 | 49.1520 |

Table 2. Single Speed (4 to 50 kHz sample rates) Common Clock Frequencies

| Sample Rate (kHz) | MCLK (MHz) | | | | See Note |
|--------------------------|-------------------|-------------|-------------|-------------|-----------------|
| | 128x | 192x | 256x | 384x | |
| 64 | 8.1920 | 12.2880 | 16.3840 | 24.5760 | 32.7680 |
| 88.2 | 11.2896 | 16.9344 | 22.5792 | 33.8688 | 45.1584 |
| 96 | 12.2880 | 18.4320 | 24.5760 | 36.8640 | 49.1520 |

Table 3. Double Speed (50 to 100 kHz sample rates) Common Clock Frequencies

| Sample Rate (kHz) | MCLK (MHz) | | | | See Note |
|--------------------------|-------------------|------------|-------------|-------------|-----------------|
| | 64x | 96x | 128x | 192x | |
| 176.4 | 11.2896 | 16.9344 | 22.5792 | 33.8688 | 45.1584 |
| 192 | 12.2880 | 18.4320 | 24.5760 | 36.8640 | 49.1520 |

Table 4. Quad Speed (100 to 200 kHz sample rates) Common Clock Frequencies

*Note: These clocking ratios are only available in Control Port Mode when the MCLK Divide bit is enabled.

3.6 Digital Interface Format

The device will accept audio samples in several digital interface formats as illustrated in Tables 5 and 8. The desired format is selected via the M0 and M1 pins for stand alone mode, and through the DIF2:0 bits in the control port. For an illustration of the required relationship between the Left/Right Clock, Serial Clock and Serial Audio Data, see Figures 4-6.

| M1 | M0 | DESCRIPTION | FORMAT | FIGURE |
|----|----|-------------------------------------|--------|--------|
| 0 | 0 | Left Justified, up to 24-bit data | 0 | 4 |
| 0 | 1 | I ² S, up to 24-bit data | 1 | 5 |
| 1 | 0 | Right Justified, 16-bit Data | 2 | 6 |
| 1 | 1 | Right Justified, 24-bit Data | 3 | 6 |

Table 5. Digital Interface Format, Stand-Alone Mode Options

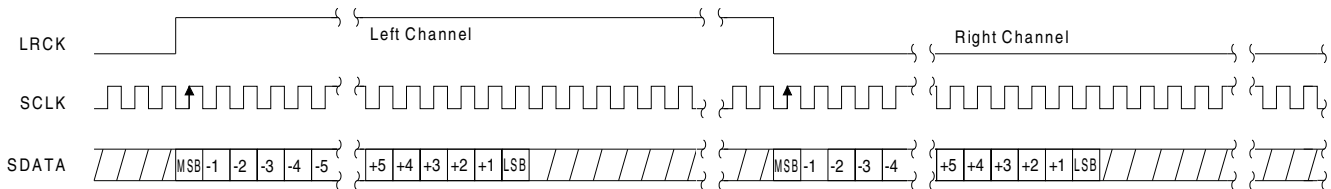

Figure 4. Format 0, Left Justified up to 24-Bit Data

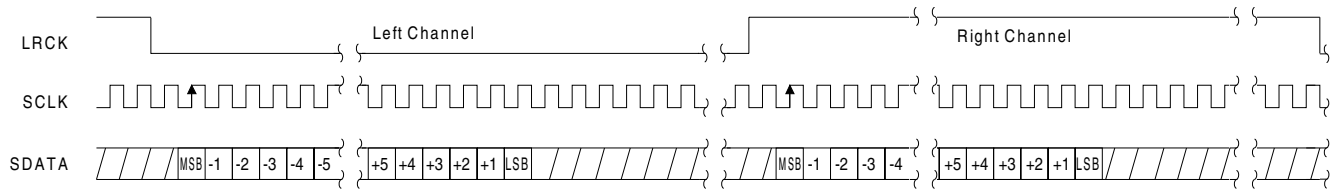

Figure 5. Format 1, I²S up to 24-Bit Data

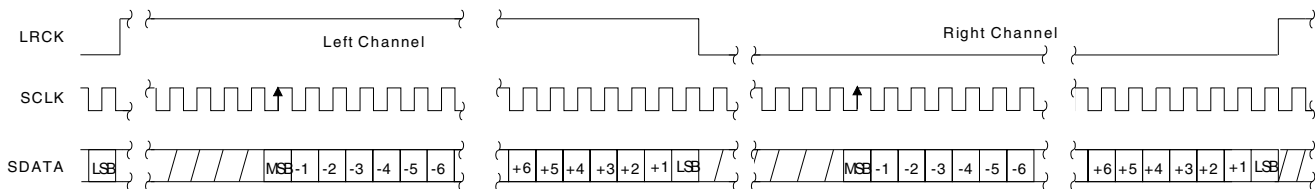

Figure 6. Format 2, Right Justified 16-Bit Data

Format 3, Right Justified 24-Bit Data

Format 4, Right Justified 20-Bit Data. (Available in Control Port Mode only)

Format 5, Right Justified 18-Bit Data. (Available in Control Port Mode only)

3.7 De-Emphasis

The device includes on-chip digital de-emphasis. Figure 7 shows the de-emphasis curve for F_S equal to 44.1 kHz. The frequency response of the de-emphasis curve will scale proportionally with changes in sample rate, F_S . Please see Table 5 for the desired de-emphasis control for Stand-alone mode and Table 10 for control port mode.

The de-emphasis feature is included to accommodate audio recordings that utilize 50/15 μ S pre-emphasis equalization as a means of noise reduction.

De-emphasis is only available in Single Speed Mode.

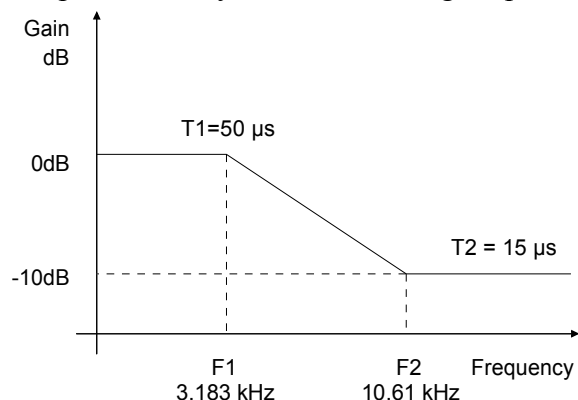

Figure 7. De-Emphasis Curve

| M2 (DEM) | DESCRIPTION | FIGURE |
|----------|---------------------|--------|
| 0 | No De-Emphasis | |
| 1 | De-Emphasis Enabled | 7 |

Table 5. De-Emphasis Select, Stand-Alone Mode

3.8 Oversampling Modes

The CS4392 operates in one of three oversampling modes based on the input sample rate. Mode selection is determined by the M3 and M2 pins in Stand-Alone mode or the FM bits in Control Port mode. Single-Speed mode supports input sample rates up to 50 kHz and uses a 128x oversampling ratio. Double-Speed mode supports input sample rates up to 100 kHz and uses an oversampling ratio of 64x. Quad-Speed mode supports input sample rates up to 200 kHz and uses an oversampling ratio of 32x

| M3 | M2 | DESCRIPTION |
|----|----|---|
| 0 | 0 | Single-Speed without De-Emphasis (4 to 50 kHz sample rates) |
| 0 | 1 | Single-Speed with 44.1kHz De-Emphasis |
| 1 | 0 | Double-Speed (50 to 100 kHz sample rates) |
| 1 | 1 | Quad-Speed (100 to 200 kHz sample rates) |

Table 6. Mode Selection, Stand-Alone Mode Options

3.9 Using DSD mode

In stand-alone mode, DSD operation is selected by holding DSD_EN(LRCK) high and applying the DSD data and clocks to the appropriate pins. The M2:0 pins set the expected DSD rate and MCLK ratio.

In control-port mode the FM bits set the device into DSD mode (DSD_EN pin is not required to be held high). The DIF register then controls the expected DSD rate and MCLK ratio.

| DSD_Mode | M2 | M1 | M0 | DESCRIPTION |
|----------|----|----|----|---|
| 1 | 0 | 0 | 0 | 64x oversampled DSD data with a 4x MCLK to DSD data rate |
| 1 | 0 | 0 | 1 | 64x oversampled DSD data with a 6x MCLK to DSD data rate |
| 1 | 0 | 1 | 0 | 64x oversampled DSD data with a 8x MCLK to DSD data rate |
| 1 | 0 | 1 | 1 | 64x oversampled DSD data with a 12x MCLK to DSD data rate |
| 1 | 1 | 0 | 0 | 128x oversampled DSD data with a 2x MCLK to DSD data rate |
| 1 | 1 | 0 | 1 | 128x oversampled DSD data with a 3x MCLK to DSD data rate |
| 1 | 1 | 1 | 0 | 128x oversampled DSD data with a 4x MCLK to DSD data rate |
| 1 | 1 | 1 | 1 | 128x oversampled DSD data with a 6x MCLK to DSD data rate |

Table 7. Direct Stream Digital (DSD), Stand-Alone Mode Options

3.10 Mute Control

The Mute Control pins go high during power-up initialization, reset, or if the Master Clock to Left Right Clock ratio is incorrect. These pins will also go high following the reception of 8192 consecutive audio samples of static 0 or -1 on both the left and right channels. A single sample of non-zero data on either channel will cause the Mute Control pins to go low. These pins are intended to be used as control for an external mute circuit in order to add off-chip mute capability.

Use of the Mute Control function is not mandatory but recommended for designs requiring the absolute minimum in extraneous clicks and pops. Also, use of the Mute Control function can enable the system designer to achieve idle channel noise/signal-to-noise ratios which are only limited by the external mute circuit. See the CDB4392 data sheet for a suggested mute circuit.

4. CONTROL PORT INTERFACE

The control port is used to load all the internal register settings (see section 6). The operation of the control port may be completely asynchronous with the audio sample rate. However, to avoid potential interference problems, the control port pins should remain static if no operation is required.

The control port operates in one of two modes: I²C or SPI.

Notes: MCLK must be applied during all I²C communication.

4.0.1 MAP Auto Increment

The device has MAP (memory address pointer) auto increment capability enabled by the INCR bit (also the MSB) of the MAP. If INCR is set to 0, MAP will stay constant for successive I²C writes or reads, and SPI writes. If INCR is set to 1, MAP will auto increment after each byte is written, allowing block reads or writes of successive registers.

4.0.2 I²C Mode

In the I²C mode, data is clocked into and out of the bi-directional serial control data line, SDA, by the serial control port clock, SCL (see Figure 8 for the clock to data relationship). There is no $\overline{\text{CS}}$ pin. Pin AD0 enables the user to alter the chip address (001000[AD0][$\overline{\text{R}/\overline{\text{W}}}$]) and should be tied to VL or AGND as required, before powering up the device. If the device ever detects a high to low transition on the AD0/ $\overline{\text{CS}}$ pin after power-up, SPI mode will be selected.

4.0.2a I²C Write

To write to the device, follow the procedure below while adhering to the control port Switching Specifications in section 7.

- 1) Initiate a START condition to the I²C bus followed by the address byte. The upper 6 bits must be 001000. The seventh bit must match the setting of the AD0 pin, and the eighth must be 0. The eighth bit of the address byte is the $\overline{\text{R}/\overline{\text{W}}}$ bit.
- 2) Wait for an acknowledge (ACK) from the part, then write to the memory address pointer, MAP. This byte points to the register to be written.
- 3) Wait for an acknowledge (ACK) from the part, then write the desired data to the register pointed to by the MAP.
- 4) If the INCR bit (see section 4.0.1) is set to 1, repeat the previous step until all the desired registers are written, then initiate a STOP condition to the bus.
- 5) If the INCR bit is set to 0 and further I²C writes to other registers are desired, it is necessary to initiate a repeated START condition and follow the procedure detailed from step 1. If no further writes to other registers are desired, initiate a STOP condition to the bus.

4.0.2b I²C Read

To read from the device, follow the procedure below while adhering to the control port *Switching Specifications*.

- 1) Initiate a START condition to the I²C bus followed by the address byte. The upper 6 bits must be 001000. The seventh bit must match the setting of the AD0 pin, and the eighth must be 1. The eighth bit of the address byte is the R/ \overline{W} bit.
- 2) After transmitting an acknowledge (ACK), the device will then transmit the contents of the register pointed to by the MAP. The MAP register will contain the address of the last register written to the MAP, or the default address (see section 4.1) if an I²C read is the first operation performed on the device.
- 3) Once the device has transmitted the contents of the register pointed to by the MAP, issue an ACK.
- 4) If the INCR bit is set to 1, the device will continue to transmit the contents of successive registers. Continue providing a clock and issue an ACK after each byte until all the desired registers are read, then initiate a STOP condition to the bus.
- 5) If the INCR bit is set to 0 and further I²C reads from other registers are desired, it is necessary to initiate a STOP condition and follow the procedure detailed from steps 1 and 2 from the I²C Write instructions followed by step 1 of the I²C Read section. If no further reads from other registers are desired, initiate a STOP condition to the bus.

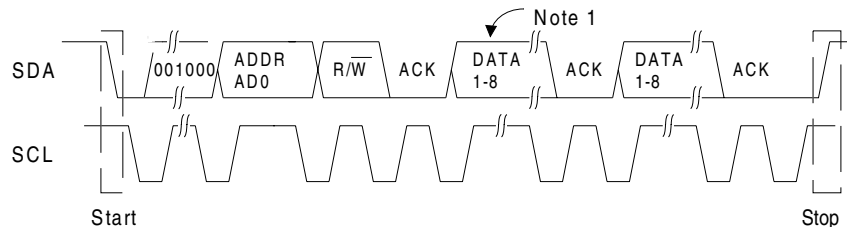

Note: If operation is a write, this byte contains the Memory Address Pointer, MAP.

Figure 8. Control Port Timing, I²C Mode

4.0.3 SPI Mode

In SPI mode, data is clocked into the serial control data line, CDIN, by the serial control port clock, CCLK (see Figure 9 for the clock to data relationship). There is no AD0 pin. Pin \overline{CS} is the chip select signal and is used to control SPI writes to the control port. When the device detects a high to low transition on the AD0/ \overline{CS} pin after power-up, SPI mode will be selected. All signals are inputs and data is clocked in on the rising edge of CCLK.

4.0.3a SPI Write

To write to the device, follow the procedure below while adhering to the control port Switching Specifications in section 7.

- 1) Bring \overline{CS} low.
- 2) The address byte on the CDIN pin must then be 00100000.
- 3) Write to the memory address pointer, MAP. This byte points to the register to be written.
- 4) Write the desired data to the register pointed to by the MAP.
- 5) If the INCR bit (see section 4.0.1) is set to 1, repeat the previous step until all the desired registers are written, then bring \overline{CS} high.
- 6) If the INCR bit is set to 0 and further SPI writes to other registers are desired, it is necessary to bring \overline{CS} high, and follow the procedure detailed from step 1. If no further writes to other registers are desired, bring \overline{CS} high.

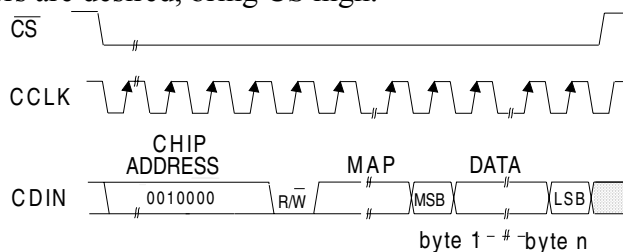

MAP = Memory Address Pointer

Figure 9. Control Port Timing, SPI mode

4.1 Memory Address Pointer (MAP)

| 7 | 6 | 5 | 4 | 3 | 2 | 1 | 0 |
|------|----------|----------|----------|------|------|------|------|
| INCR | Reserved | Reserved | Reserved | MAP3 | MAP2 | MAP1 | MAP0 |
| 0 | 0 | 0 | 0 | 0 | 0 | 0 | 0 |

4.1.1 INCR (AUTO MAP INCREMENT ENABLE)

Default = '0'

0 - Disabled, the MAP will stay constant for successive writes

1 - Enabled, the MAP will auto increment after each byte is written, allowing block reads or writes of successive registers

4.1.2 MAP3-0 (MEMORY ADDRESS POINTER)

Default = '0000'

5. REGISTER QUICK REFERENCE

| Addr | Function | 7 | 6 | 5 | 4 | 3 | 2 | 1 | 0 |
|------|---------------------------|----------|----------|------------|----------|-------------|--------|----------|----------|
| 01h | Mode Control 1 | AMUTE | DIF2 | DIF1 | DIF0 | DEM1 | DEM0 | FM1 | FM0 |
| | | 1 | 0 | 0 | 0 | 0 | 0 | 0 | 0 |
| 02h | Volume and Mixing Control | A = B | Soft | Zero Cross | ATAPI4 | ATAPI3 | ATAPI2 | ATAPI1 | ATAPI0 |
| | | 0 | 1 | 0 | 0 | 1 | 0 | 0 | 1 |
| 03h | Channel A Volume Control | MUTE | VOL6 | VOL5 | VOL4 | VOL3 | VOL2 | VOL1 | VOL0 |
| | | 0 | 0 | 0 | 0 | 0 | 0 | 0 | 0 |
| 04h | Channel B Volume Control | MUTE | VOL6 | VOL5 | VOL4 | VOL3 | VOL2 | VOL1 | VOL0 |
| | | 0 | 0 | 0 | 0 | 0 | 0 | 0 | 0 |
| 05h | Mode Control 2 | INVERT_A | INVERT_B | CPEN | PDN | MUTEC A = B | FREEZE | MCLKDIV2 | Reserved |
| | | 0 | 0 | 0 | 1 | 0 | 0 | 0 | 0 |
| 06h | Mode Control 3 | Reserved | Reserved | Reserved | FILT_SEL | RMP_UP | RMP_DN | Reserved | Reserved |
| | | 0 | 0 | 0 | 0 | 0 | 0 | 0 | 0 |
| 07h | Chip ID | PART3 | PART2 | PART1 | PART0 | REV3 | REV2 | REV1 | REV0 |
| | | 1 | 0 | 0 | 0 | - | - | - | - |

6. REGISTER DESCRIPTION

** All registers are read/write in Two-Wire mode and write only in SPI mode, unless otherwise noted**

6.1 Mode Control 1 - Address 01h

| | | | | | | | |
|-------|------|------|------|------|------|-----|-----|
| 7 | 6 | 5 | 4 | 3 | 2 | 1 | 0 |
| AMUTE | DIF2 | DIF1 | DIF0 | DEM1 | DEM0 | FM1 | FM0 |

6.1.1 Auto-Mute (Bit 7)

Function:

The Digital-to-Analog converter output will mute following the reception of 8192 consecutive audio samples of static 0 or -1. A single sample of non-static data will release the mute. Detection and muting is done independently for each channel. (However, Auto-Mute detection and muting can become dependent on either channel if the Mute A = B function is enabled.) The common mode on the output will be retained and the Mute Control pin for that channel will go active during the mute period. The muting function is effected, similar to volume control changes, by the Soft and Zero Cross bits in the Volume and Mixing Control register.

6.1.2 Digital Interface Formats (Bits 6:4)

Function:

PCM Mode - The required relationship between the Left/Right clock, serial clock and serial data is defined by the Digital Interface Format and the options are detailed in Table 8 and Figures 4-6.

| DIF2 | DIF1 | DIF0 | DESCRIPTION | Format | Figure |
|------|------|------|---|--------|--------|
| 0 | 0 | 0 | Left Justified, up to 24-bit data (default) | 0 | 4 |
| 0 | 0 | 1 | I ² S, up to 24-bit data | 1 | 5 |
| 0 | 1 | 0 | Right Justified, 16-bit Data | 2 | 6 |
| 0 | 1 | 1 | Right Justified, 24-bit Data | 3 | 6 |
| 1 | 0 | 0 | Right Justified, 20-bit Data | 4 | 6 |
| 1 | 0 | 1 | Right Justified, 18-bit Data | 5 | 6 |
| 1 | 1 | 0 | Reserved | | |
| 1 | 1 | 1 | Reserved | | |

Table 8. Digital Interface Formats - PCM Modes

DSD Mode - The relationship between the oversampling ratio of the DSD audio data and the required Master clock to DSD data rate is defined by the Digital interface Format pins. Note that the Functional Mode registers must be set to DSD Mode. See 9 for register options.

| DIF2 | DIF1 | DIFO | DESCRIPTION |
|------|------|------|--|
| 0 | 0 | 0 | 64x oversampled DSD data with a 4x MCLK to DSD data rate (default) |
| 0 | 0 | 1 | 64x oversampled DSD data with a 6x MCLK to DSD data rate |
| 0 | 1 | 0 | 64x oversampled DSD data with a 8x MCLK to DSD data rate |
| 0 | 1 | 1 | 64x oversampled DSD data with a 12x MCLK to DSD data rate |
| 1 | 0 | 0 | 128x oversampled DSD data with a 2x MCLK to DSD data rate |
| 1 | 0 | 1 | 128x oversampled DSD data with a 3x MCLK to DSD data rate |
| 1 | 1 | 0 | 128x oversampled DSD data with a 4x MCLK to DSD data rate |
| 1 | 1 | 1 | 128x oversampled DSD data with a 6x MCLK to DSD data rate |

Table 9. Digital Interface Formats - DSD Mode

6.1.3 De-Emphasis Control (Bits 3:2)

Function:

Implementation of the standard 15 μ s/50 μ s digital de-emphasis filter response, Figure 7, requires re-configuration of the digital filter to maintain the proper filter response for 32, 44.1 or 48 kHz sample rates. NOTE: De-emphasis is available only in Single-Speed Mode. See 10 below.

| DEM1 | DEMO | DESCRIPTION |
|------|------|----------------------|
| 0 | 0 | Disabled (default) |
| 0 | 1 | 44.1 kHz de-emphasis |
| 1 | 0 | 48 kHz de-emphasis |
| 1 | 1 | 32 kHz de-emphasis |

Table 10. De-Emphasis Mode Selection

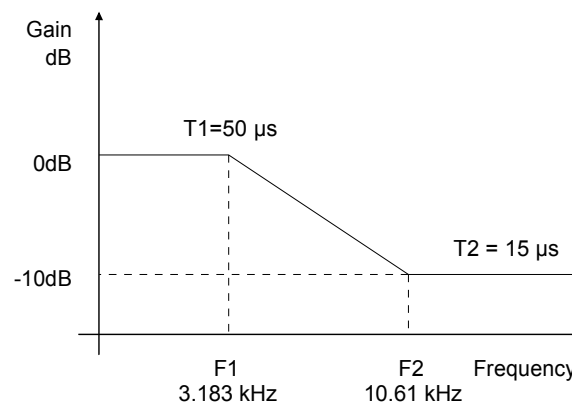

Figure 10. De-Emphasis Curve

6.1.4 Functional Mode (Bits 1:0)

Function:

Selects the required range of input sample rates or DSD Mode. See Table 11.

| FM1 | FM0 | MODE |
|-----|-----|---|
| 0 | 0 | Single-Speed Mode: 4 to 50 kHz sample rates (default) |
| 0 | 1 | Double-Speed Mode: 50 to 100 kHz sample rates |
| 1 | 0 | Quad-Speed Mode: 100 to 200 kHz sample rates |
| 1 | 1 | Direct Stream Digital Mode |

Table 11. Functional Mode Selection

6.2 Volume and Mixing Control (Address 02h)

| | | | | | | | |
|-------|------|------------|--------|--------|--------|--------|--------|
| 7 | 6 | 5 | 4 | 3 | 2 | 1 | 0 |
| A = B | Soft | Zero Cross | ATAPI4 | ATAPI3 | ATAPI2 | ATAPI1 | ATAPI0 |

6.2.1 Channel A Volume = Channel B Volume (Bit 7)

Function:

The AOUTA and AOUTB volume levels are independently controlled by the A and the B Channel Volume Control Bytes when this function is disabled. The volume on both AOUTA and AOUTB are determined by the A Channel Volume Control Byte and the B Channel Byte is ignored when this function is enabled.

6.2.2 Soft Ramp or Zero Cross Enable (Bits 6:5)

Function:

Soft Ramp Enable

Soft Ramp allows level changes, both muting and attenuation, to be implemented by incrementally ramping, in 1/8 dB steps, from the current level to the new level at a rate of 1dB per 8 left/right clock periods.

Zero Cross Enable

Zero Cross Enable dictates that signal level changes, either by attenuation changes or muting, will occur on a signal zero crossing to minimize audible artifacts. The requested level change will occur after a timeout period between 512 and 1024 sample periods (10.7 ms to 21.3 ms at 48 kHz sample rate) if the signal does not encounter a zero crossing. The zero cross function is independently monitored and implemented for each channel.

Soft Ramp and Zero Cross Enable

Soft Ramp and Zero Cross Enable dictates that signal level changes, either by attenuation changes or muting, will occur in 1/8 dB steps and be implemented on a signal zero crossing. The 1/8 dB level change will occur after a timeout period between 512 and 1024 sample periods (10.7 ms to 21.3 ms at 48 kHz sample rate) if the signal does not encounter a zero crossing. The zero cross function is independently monitored and implemented for each channel. See Table 12

| SOFT | ZERO | Mode |
|------|------|----------------------------------|
| 0 | 0 | Changes to affect immediately |
| 0 | 1 | Zero Cross enabled |
| 1 | 0 | Soft Ramp enabled (default) |
| 1 | 1 | Soft Ramp and Zero Cross enabled |

Table 12. Soft Cross or Zero Cross Mode Selection

6.2.3 ATAPI Channel Mixing and Muting (Bits 4:0)

Function:

The CS4392 implements the channel mixing functions of the ATAPI CD-ROM specification. See Table 13 on page 21

| ATAPI4 | ATAPI3 | ATAPI2 | ATAPI1 | ATAPI0 | AOUTA | AOUTB |
|--------|--------|--------|--------|--------|---------------|---------------|
| 0 | 0 | 0 | 0 | 0 | MUTE | MUTE |
| 0 | 0 | 0 | 0 | 1 | MUTE | bR |
| 0 | 0 | 0 | 1 | 0 | MUTE | bL |
| 0 | 0 | 0 | 1 | 1 | MUTE | $b[(L+R)/2]$ |
| 0 | 0 | 1 | 0 | 0 | aR | MUTE |
| 0 | 0 | 1 | 0 | 1 | aR | bR |
| 0 | 0 | 1 | 1 | 0 | aR | bL |
| 0 | 0 | 1 | 1 | 1 | aR | $b[(L+R)/2]$ |
| 0 | 1 | 0 | 0 | 0 | aL | MUTE |
| 0 | 1 | 0 | 0 | 1 | aL | bR |
| 0 | 1 | 0 | 1 | 0 | aL | bL |
| 0 | 1 | 0 | 1 | 1 | aL | $b[(L+R)/2]$ |
| 0 | 1 | 1 | 0 | 0 | $a[(L+R)/2]$ | MUTE |
| 0 | 1 | 1 | 0 | 1 | $a[(L+R)/2]$ | bR |
| 0 | 1 | 1 | 1 | 0 | $a[(L+R)/2]$ | bL |
| 0 | 1 | 1 | 1 | 1 | $a[(L+R)/2]$ | $b[(L+R)/2]$ |
| 1 | 0 | 0 | 0 | 0 | MUTE | MUTE |
| 1 | 0 | 0 | 0 | 1 | MUTE | bR |
| 1 | 0 | 0 | 1 | 0 | MUTE | bL |
| 1 | 0 | 0 | 1 | 1 | MUTE | $[(bL+aR)/2]$ |
| 1 | 0 | 1 | 0 | 0 | aR | MUTE |
| 1 | 0 | 1 | 0 | 1 | aR | bR |
| 1 | 0 | 1 | 1 | 0 | aR | bL |
| 1 | 0 | 1 | 1 | 1 | aR | $[(aL+bR)/2]$ |
| 1 | 1 | 0 | 0 | 0 | aL | MUTE |
| 1 | 1 | 0 | 0 | 1 | aL | bR |
| 1 | 1 | 0 | 1 | 0 | aL | bL |
| 1 | 1 | 0 | 1 | 1 | aL | $[(aL+bR)/2]$ |
| 1 | 1 | 1 | 0 | 0 | $[(aL+bR)/2]$ | MUTE |
| 1 | 1 | 1 | 0 | 1 | $[(aL+bR)/2]$ | bR |
| 1 | 1 | 1 | 1 | 0 | $[(bL+aR)/2]$ | bL |
| 1 | 1 | 1 | 1 | 1 | $[(aL+bR)/2]$ | $[(aL+bR)/2]$ |

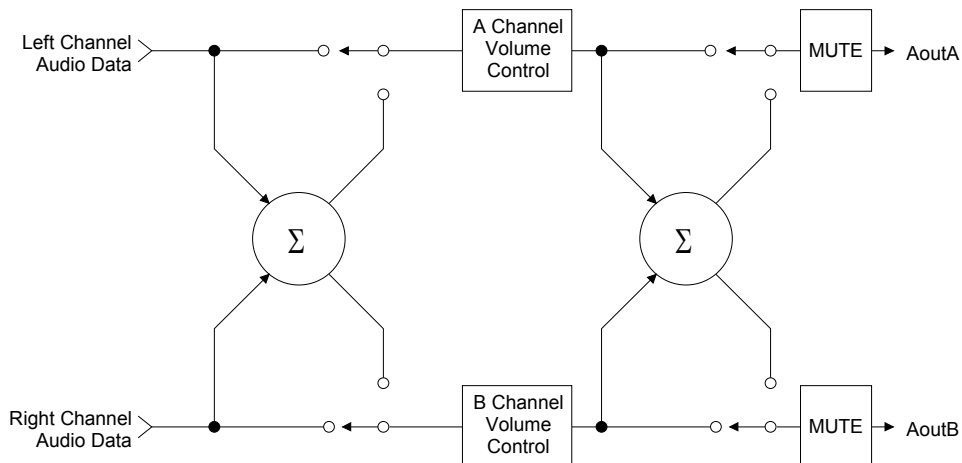
Table 13. ATAPI Decode

Figure 11. ATAPI Block Diagram

6.3 Channel A Volume Control - Address 03h

See 4.4 Channel B Volume Control - Address 04h

6.4 CHANNEL B VOLUME CONTROL - ADDRESS 04H

| | | | | | | | |
|------|------|------|------|------|------|------|------|
| 7 | 6 | 5 | 4 | 3 | 2 | 1 | 0 |
| MUTE | VOL6 | VOL5 | VOL4 | VOL3 | VOL2 | VOL1 | VOL0 |

6.4.1 Mute (Bit 7)

Function:

The Digital-to-Analog converter output will mute when enabled. The common mode voltage on the output will be retained. The muting function is effected, similar to attenuation changes, by the Soft and Zero Cross bits in the Volume and Mixing Control register. The MUTEC pin for that channel will go active during the mute period if the Mute function is enabled. Both the AMUTEC and BMUTEC will go active if either MUTE register is enabled and the MUTEC A = B bit (register 5) is enabled.

6.4.2 Volume Control (Bits 6:0)

Function:

The digital volume control allows the user to attenuate the signal in 1 dB increments from 0 to -127 dB. Volume settings are decoded as shown in Table 14. The volume changes are implemented as dictated by the Soft and Zero Cross bits in the Volume and Mixing Control register (see section 6.2.2).

| Binary Code | Decimal Value | Volume Setting |
|-------------|---------------|----------------|
| 0000000 | 0 | 0 dB |
| 0010100 | 20 | -20 dB |
| 0101000 | 40 | -40 dB |
| 0111100 | 60 | -60 dB |
| 1011010 | 90 | -90 dB |

Table 14. Digital Volume Control Example Settings

6.5 Mode Control 2 - Address 05h

| | | | | | | | |
|----------|----------|------|-----|-------------|--------|----------|----------|
| 7 | 6 | 5 | 4 | 3 | 2 | 1 | 0 |
| INVERT_A | INVERT_B | CPEN | PDN | MUTEC A = B | FREEZE | MCLKDIV2 | Reserved |

6.5.1 Invert Signal Polarity (Bits 7:6)

Function:

When set to 1, this bit inverts the signal polarity for the appropriate channel. This is useful if a board layout error has occurred, or in other situations where a 180 degree phase shift is desirable. Default is 0.

6.5.2 Control Port Enable (Bit 5)

Function:

This bit defaults to 0, allowing the device to power-up in Stand-Alone mode. The Control port mode can be accessed by setting this bit to 1. This will allow the operation of the device to be controlled by the registers and the pin definitions will conform to Control Port Mode. To accomplish a clean power-up, the user should write 30h to register 5 within 10 ms following the release of Reset.

6.5.3 Power Down (Bit 4)

Function:

The device will enter a low-power state whenever this function is activated (set to 1). The power-down bit defaults to 'enabled' (1) on power-up and must be disabled before normal operation will begin. The contents of the control registers are retained when the device is in power-down.

6.5.4 AMUTEC = BMUTEC (Bit 3)

Function:

When this function is enabled, the individual controls for AMUTEC and BMUTEC are internally connected through a AND gate prior to the output pins. Therefore, the external AMUTEC and BMUTEC pins will go active only when the requirements for both AMUTEC and BMUTEC are valid.

6.5.5 Freeze (Bit 2)

Function:

This function allows modifications to the control port registers without the changes taking effect until Freeze is disabled. To make multiple changes in the Control port registers take effect simultaneously, set the Freeze Bit, make all register changes, then Disable the Freeze bit.

6.5.6 Master Clock Divide (Bit 1)

Function:

This function allows the user to select an internal divide by 2 of the Master Clock. This selection is required to access the higher Master Clock rates as shown in Tables 2 through 4 on page 10.

6.6 Mode Control 3 - Address 06h

| B7 | B6 | B5 | B4 | B3 | B2 | B1 | B0 |
|----------|----------|----------|----------|--------|--------|----------|----------|
| Reserved | Reserved | Reserved | FILT_SEL | RMP_UP | RMP_DN | Reserved | Reserved |

6.6.1 Interpolation Filter Select (Bit 4)

Function:

This Function allows the user to select whether the Interpolation Filter has a fast (set to 0 - default) or slow (set to 1) roll off. The - 3dB corner is approximately the same for both filters, but the slope of the roll off is greater for the 'fast' roll off filter.

6.6.2 *Soft Volume Ramp-up after Reset (Bit 3)*

Function:

This function allows the user to control whether a soft ramp up in volume is applied when reset is released either by the reset pin or internal to the chip. The modes are as follows:

0 - An instantaneous change is made from max attenuation to the control port volume setting on release of reset (default setting).

1 - Volume is ramped up using the soft-ramp settings in Bits 6:5 of register 02h (see 6.2.2) from max attenuation to the control port volume setting on release of reset.

6.6.3 *Soft Ramp-down before Reset (Bit 2)*

Function:

This function allows the user to control if a soft ramp-down in volume is applied before a known reset condition. The modes are as follows:

0 - An instantaneous change is made from the control port volume setting to max attenuation when chip resets (default setting).

1 - Volume is ramped down using the soft-ramp settings in Bits 6:5 of register 02h (see 6.2.2) from the control port volume setting to max attenuation when chip resets.

6.7 **Chip ID - Register 07h**

| B7 | B6 | B5 | B4 | B3 | B2 | B1 | B0 |
|-----------|-----------|-----------|-----------|-----------|-----------|-----------|-----------|
| PART3 | PART2 | PART1 | PART0 | REV3 | REV2 | REV1 | REV0 |

Function:

This register is Read-Only. Bits 7 through 4 are the part number ID which is 1000b (8h) and the remaining Bits (3 through 0) are for the chip revision.

7. CHARACTERISTICS/SPECIFICATIONS

ANALOG CHARACTERISTICS (CS4392-KS/KZ/KZZ) ((Test conditions (unless otherwise specified): Input test signal is a 997 Hz sine wave at 0 dBFS; measurement bandwidth is 10 Hz to 20 kHz; test load $R_L = 3k\Omega$, $C_L = 10$ pF. Typical performance characteristics are derived from measurements taken at $T_A = 25$ °C, $V_L = V_A = 5.0V$. Min/Max performance characteristics are guaranteed over the specified operating temperature and voltages.)

| Parameter | Symbol | VA = 5.0V | | | Unit |
|---|--------------------|-----------|---------|---------|------------|
| | | Min | Typ | Max | |
| Dynamic Performance for All Speed Modes and DSD | | | | | |
| Dynamic Range (Note 1) | unweighted | 105 | 111 | - | dB |
| | A-Weighted | 108 | 114 | - | dB |
| Total Harmonic Distortion + Noise (Note 1) | 0 dB | - | -100 | -94 | dB |
| | -20 dB | - | -91 | - | dB |
| | -60 dB | - | -51 | -45 | dB |
| Idle Channel Noise / Signal-to-Noise Ratio | | - | 114 | - | dB |
| Interchannel Isolation | (1 kHz) | - | 100 | - | dB |
| DC Accuracy | | | | | |
| Interchannel Gain Mismatch | ICGM | - | 0.1 | - | dB |
| Gain Drift | | - | 100 | - | ppm/°C |
| Analog Output Characteristics and Specifications | | | | | |
| Full Scale Differential Output Voltage | V_{FS} | 0.95xVA | 0.99xVA | 1.05xVA | Vpp |
| Output Resistance | (Note 2) Z_{out} | - | 100 | - | Ω |
| Minimum AC-Load Resistance | R_L | - | 3 | - | k Ω |
| Maximum Load Capacitance | C_L | - | 100 | - | pF |

- Notes: 1. One-half LSB of Triangular PDF dither is added to data.
 2. V_{FS} is tested under load R_L but does not include attenuation due to Z_{OUT}

COMBINED INTERPOLATION & ON-CHIP ANALOG FILTER RESPONSE (The filter characteristics and the X-axis of the response plots have been normalized to the sample rate (Fs) and can be referenced to the desired sample rate by multiplying the given characteristic by Fs.)

| Parameter | Fast Roll-Off | | | Unit | |
|---|--------------------|--------|----------|-------|-----|
| | Min | Typ | Max | | |
| Single-Speed Mode - (4 kHz to 50 kHz sample rates) | | | | | |
| Passband | to -0.01 dB corner | 0 | - | 0.454 | Fs |
| | to -3 dB corner | 0 | - | 0.499 | Fs |
| Frequency Response 10 Hz to 20 kHz | -0.01 | - | +0.01 | | dB |
| StopBand | 0.547 | - | - | | Fs |
| StopBand Attenuation (Note 4) | 90 | - | - | | dB |
| Group Delay | - | 12/Fs | - | | s |
| Passband Group Delay Deviation 0 - 20 kHz | - | - | ±0.41/Fs | | s |
| De-emphasis Error (Relative to 1kHz) (Note 5) | Fs = 32 kHz | - | - | ±0.23 | dB |
| | Fs = 44.1 kHz | - | - | ±0.14 | dB |
| | Fs = 48 kHz | - | - | ±0.09 | dB |
| Double-Speed Mode - (50 kHz to 100 kHz sample rates) | | | | | |
| Passband | to -0.01 dB corner | 0 | - | 0.430 | Fs |
| | to -3 dB corner | 0 | - | 0.499 | Fs |
| Frequency Response 10 Hz to 20 kHz | -0.01 | - | 0.01 | | dB |
| StopBand | 0.583 | - | - | | Fs |
| StopBand Attenuation (Note 4) | 80 | - | - | | dB |
| Group Delay | - | 4.6/Fs | - | | s |
| Passband Group Delay Deviation 0 - 20 kHz | - | - | ±0.03/Fs | | s |
| Quad Speed Mode - (100 kHz to 200 kHz) | | | | | |
| Passband | to -0.01 dB corner | 0 | - | 0.105 | Fs |
| | to -3 dB corner | 0 | - | 0.490 | Fs |
| Frequency Response 10 Hz to 20 kHz | -0.01 | - | 0.01 | | dB |
| StopBand | 0.635 | - | - | | Fs |
| StopBand Attenuation (Note 4) | 90 | - | - | | dB |
| Group Delay | - | 4.7/Fs | - | | s |
| Passband Group Delay Deviation 0 - 20 kHz | - | - | ±0.01/Fs | | s |
| DSD Mode | | | | | |
| Passband | to -0.1 dB corner | 0 | - | 20 | kHz |
| | to -3 dB corner | 0 | - | 120 | kHz |
| Frequency Response 10 Hz to 20 kHz | -0.1 | - | 0.1 | | dB |

COMBINED INTERPOLATION & ON-CHIP ANALOG FILTER RESPONSE (Cont.)

| Parameter | Slow Roll-Off (Note 3) | | | Unit | |
|---|------------------------|--------|----------|-------|-----|
| | Min | Typ | Max | | |
| Single-Speed Mode - (4 kHz to 50 kHz sample rates) | | | | | |
| Passband | to -0.01 dB corner | 0 | - | 0.417 | Fs |
| | to -3 dB corner | 0 | - | 0.499 | Fs |
| Frequency Response 10 Hz to 20 kHz | -0.01 | - | +0.01 | | dB |
| StopBand | 0.583 | - | - | | Fs |
| StopBand Attenuation (Note 4) | 64 | - | - | | dB |
| Group Delay | - | 6.5/Fs | - | | s |
| Passband Group Delay Deviation 0 - 20 kHz | - | - | ±0.14/Fs | | s |
| De-emphasis Error (Relative to 1kHz) (Note 5) | Fs = 32 kHz | - | - | ±0.23 | dB |
| | Fs = 44.1 kHz | - | - | ±0.14 | dB |
| | Fs = 48 kHz | - | - | ±0.09 | dB |
| Double-Speed Mode - (50 kHz to 100 kHz sample rates) | | | | | |
| Passband | to -0.01 dB corner | 0 | - | 0.296 | Fs |
| | to -3 dB corner | 0 | - | 0.499 | Fs |
| Frequency Response 10 Hz to 20 kHz | -0.01 | - | 0.01 | | dB |
| StopBand | 0.792 | - | - | | Fs |
| StopBand Attenuation (Note 4) | 70 | - | - | | dB |
| Group Delay | - | 3.9/Fs | - | | s |
| Passband Group Delay Deviation 0 - 20 kHz | - | - | ±0.01/Fs | | s |
| Quad Speed Mode - (100 kHz to 200 kHz) | | | | | |
| Passband | to -0.01 dB corner | 0 | - | 0.104 | Fs |
| | to -3 dB corner | 0 | - | 0.481 | Fs |
| Frequency Response 10 Hz to 20 kHz | -0.01 | - | 0.01 | | dB |
| StopBand | 0.868 | - | - | | Fs |
| StopBand Attenuation (Note 4) | 75 | - | - | | dB |
| Group Delay | - | 4.2/Fs | - | | s |
| Passband Group Delay Deviation 0 - 20 kHz | - | - | ±0.01/Fs | | s |
| DSD Mode | | | | | |
| Passband | to -0.1 dB corner | 0 | - | 20 | kHz |
| | to -3 dB corner | 0 | - | 120 | kHz |
| Frequency Response 10 Hz to 20 kHz | -0.01 | - | 0.1 | | dB |

- Notes:
3. Slow Roll-Off interpolation filter is only available in control port mode.
 4. For Single and Double-Speed Mode, the Measurement Bandwidth is from stopband to 3 Fs. For Quad-Speed Mode, the Measurement Bandwidth is from stopband to 1.34 Fs.
 5. De-emphasis is only available in Single Speed Mode; The 44.1kHz De-emphasis filter is the only filter available in Stand-Alone Mode.

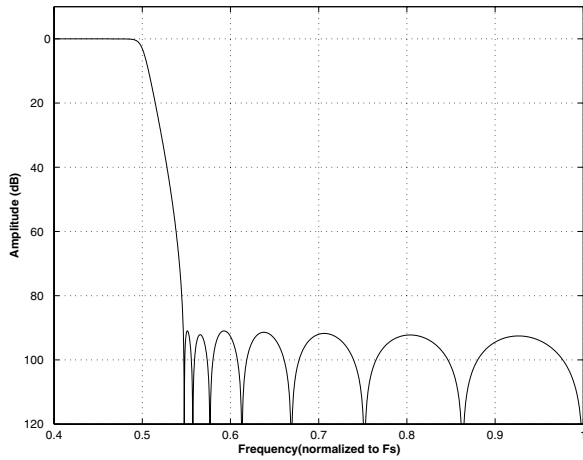
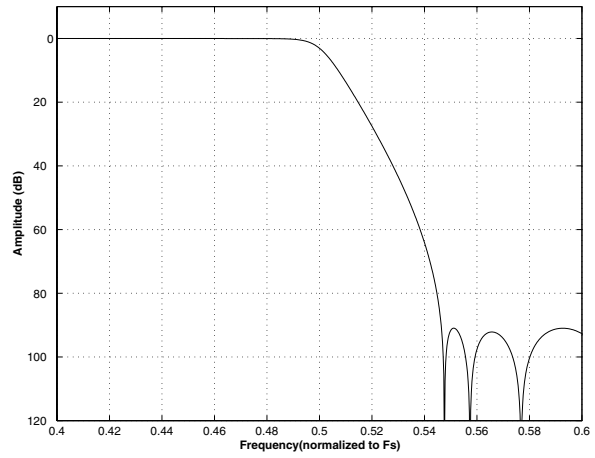
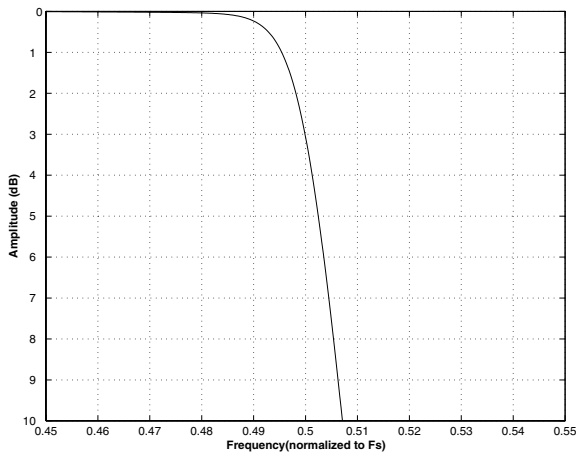
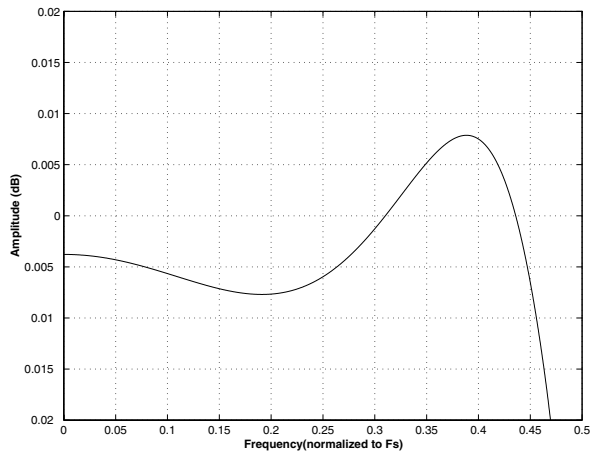
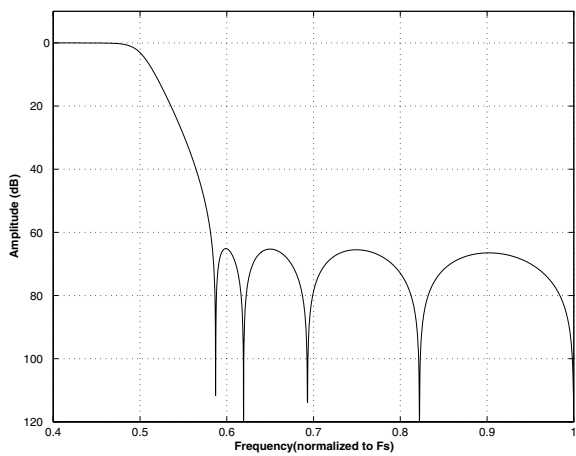
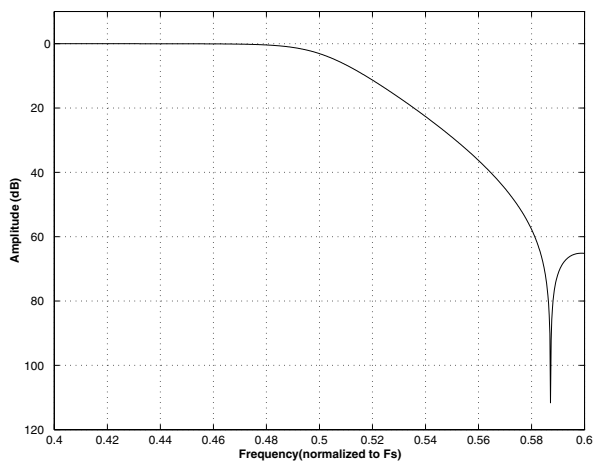
Figure 12. Single Speed (fast) Stopband Rejection

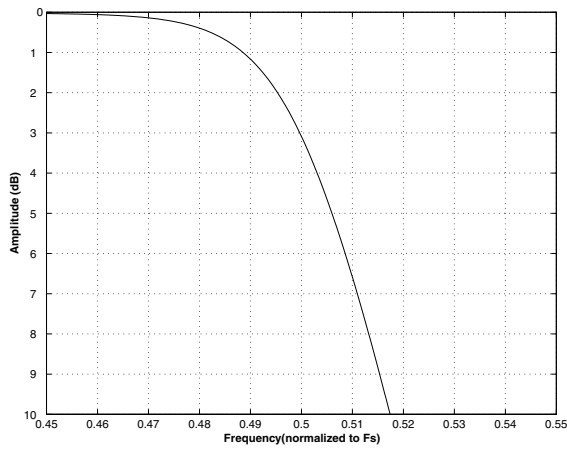
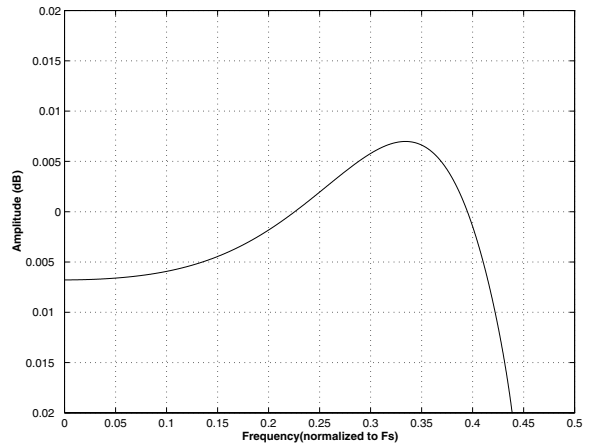
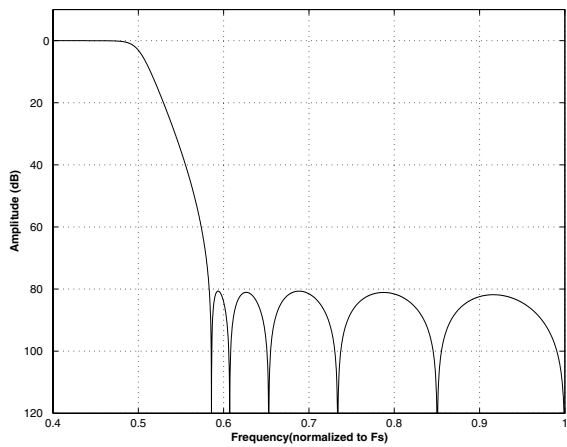
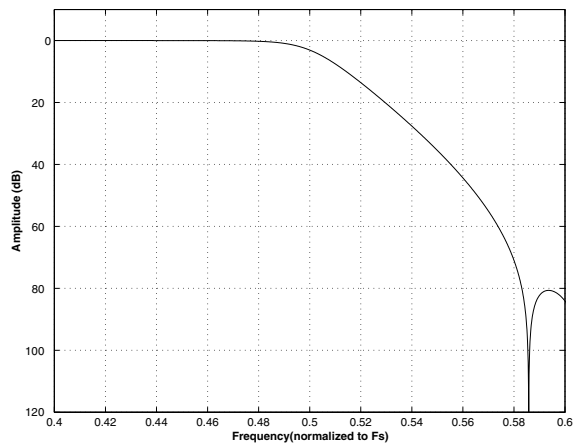
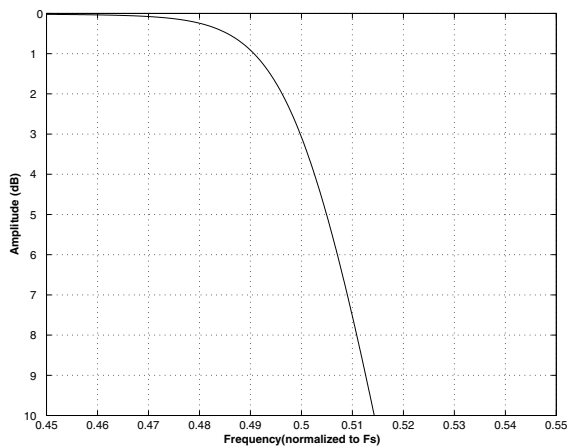
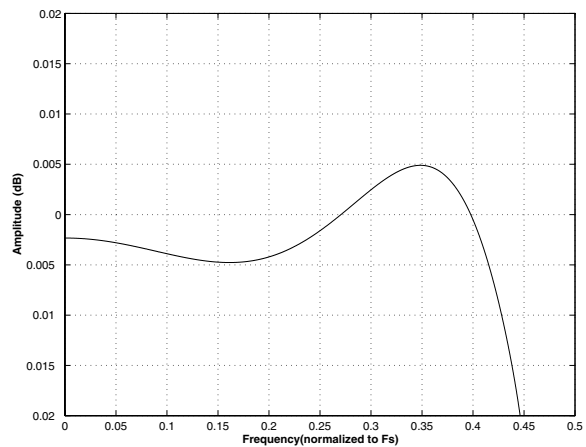
Figure 13. Single Speed (fast) Transition Band

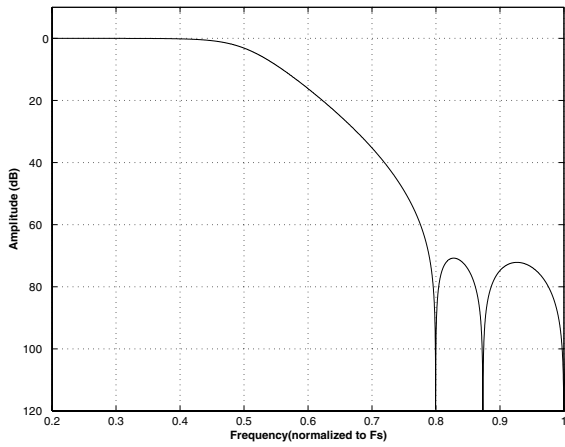
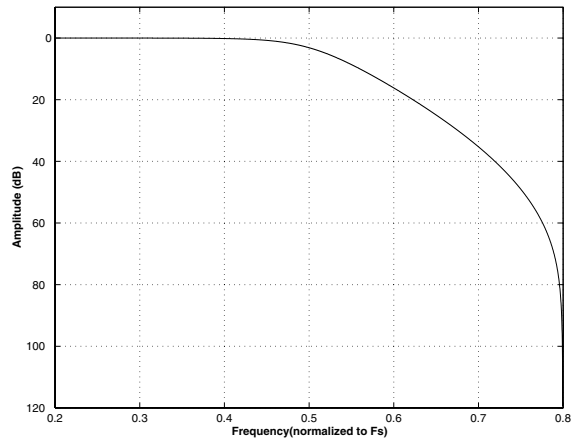
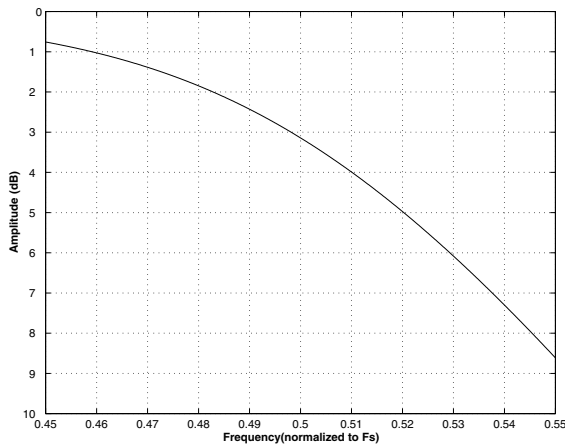
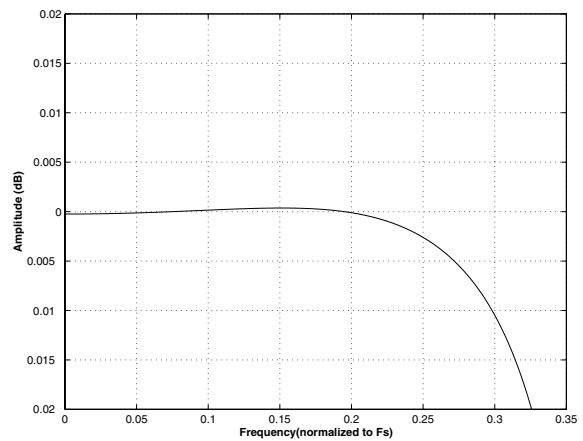
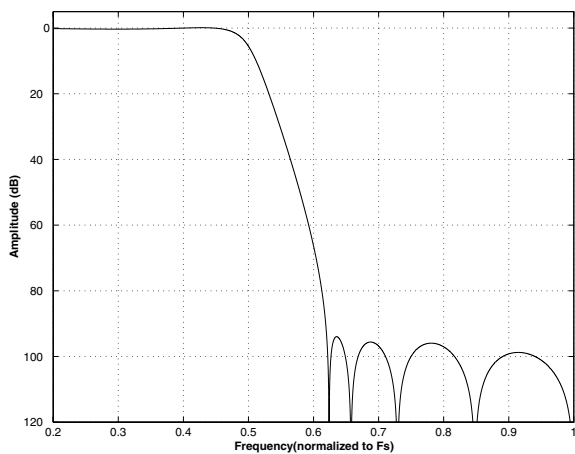
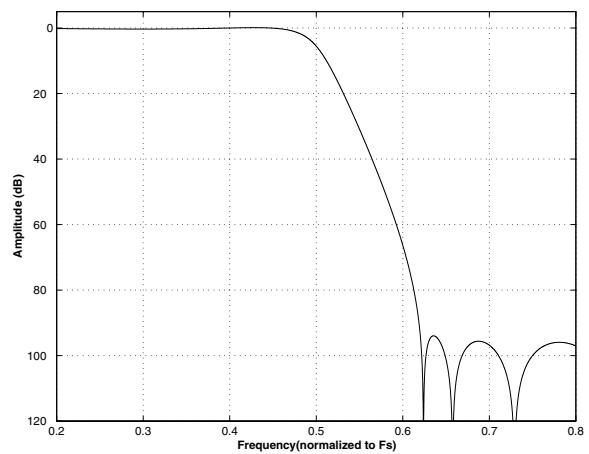
Figure 14. Single Speed (fast) Transition Band (detail)

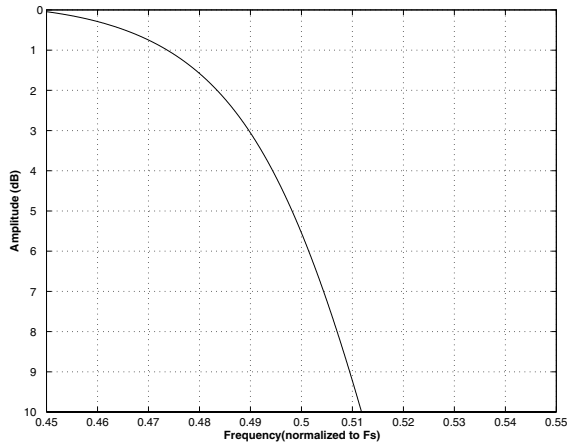
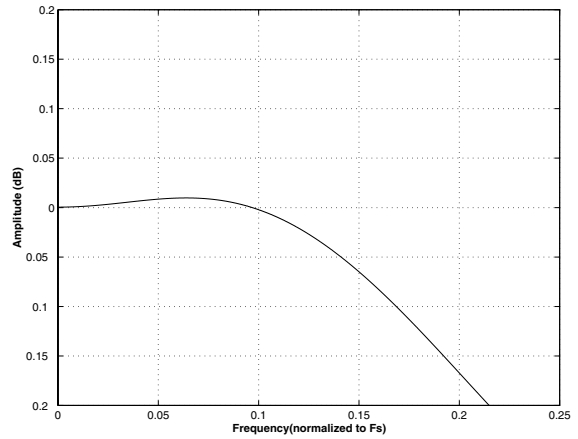
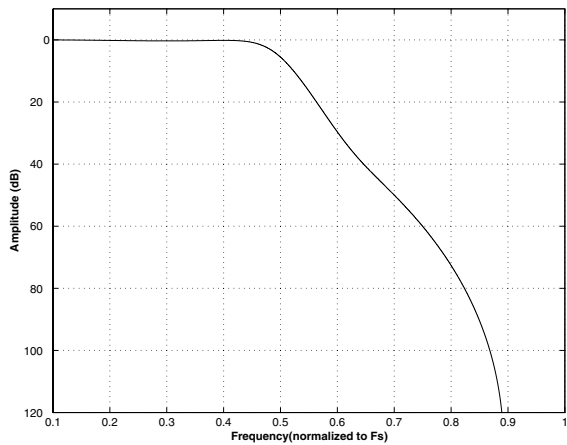
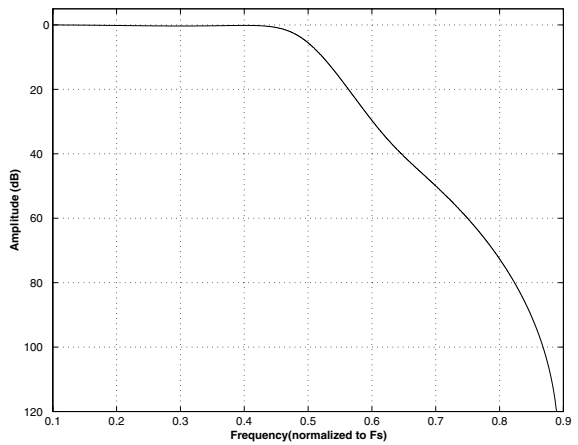
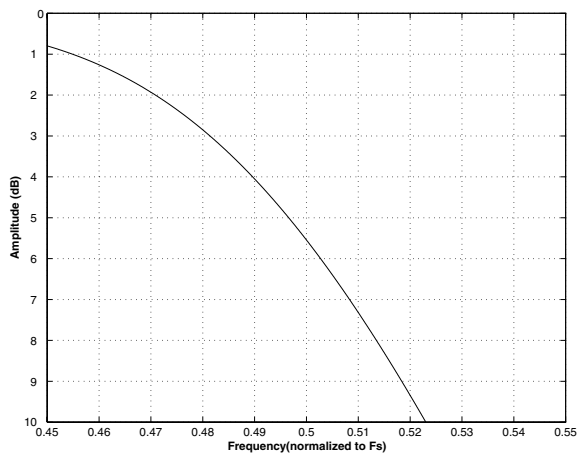
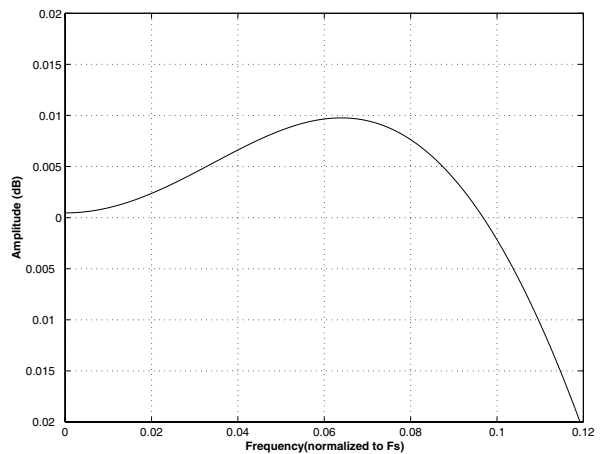
Figure 15. Single Speed (fast) Passband Ripple

Figure 16. Single Speed (slow) Stopband Rejection

Figure 17. Single Speed (slow) Transition Band

Figure 18. Single Speed (slow) Transition Band (detail)

Figure 19. Single Speed (slow) Passband Ripple

Figure 20. Double Speed (fast) Stopband Rejection

Figure 21. Double Speed (fast) Transition Band

Figure 22. Double Speed (fast) Transition Band (detail)

Figure 23. Double Speed (fast) Passband Ripple

Figure 24. Double Speed (slow) Stopband Rejection

Figure 25. Double Speed (slow) Transition Band

Figure 26. Double Speed (slow) Transition Band (detail)

Figure 27. Double Speed (slow) Passband Ripple

Figure 28. Quad Speed (fast) Stopband Rejection

Figure 29. Quad Speed (fast) Transition Band

Figure 30. Quad Speed (fast) Transition Band (detail)

Figure 31. Quad Speed (fast) Passband Ripple

Figure 32. Quad Speed (slow) Stopband Rejection

Figure 33. Quad Speed (slow) Transition Band

Figure 34. Quad Speed (slow) Transition Band (detail)

Figure 35. Quad Speed (slow) Passband Ripple

SWITCHING CHARACTERISTICS - SERIAL AUDIO INTERFACE

(Inputs: Logic 0 = 0 V, Logic 1 = VL) .

| Parameters | Symbol | Min | Typ | Max | Units |
|---------------------------------------|-----------------------------|-----|-----|-------------------------|-------|
| Input Sample Rate | F_s | 4 | - | 200 | kHz |
| LRCK Duty Cycle | | 45 | 50 | 55 | % |
| MCLK Duty Cycle | | 40 | 50 | 60 | % |
| SCLK Frequency | Single Speed Mode | - | - | $128 \cdot \text{LRCK}$ | Hz |
| | Double Speed Mode | - | - | $64 \cdot \text{LRCK}$ | Hz |
| | Quad Speed Mode (MCLKDIV=0) | - | - | $\text{MCLK}/2$ | Hz |
| | Quad Speed Mode (MCLKDIV=1) | - | - | $\text{MCLK}/4$ | Hz |
| SCLK rising to LRCK edge delay | t_{sldr} | 20 | - | - | ns |
| SCLK rising to LRCK edge setup time | t_{sdrs} | 20 | - | - | ns |
| SDATA valid to SCLK rising setup time | t_{sdlrs} | 20 | - | - | ns |
| SCLK rising to SDATA hold time | t_{sdh} | 20 | - | - | ns |

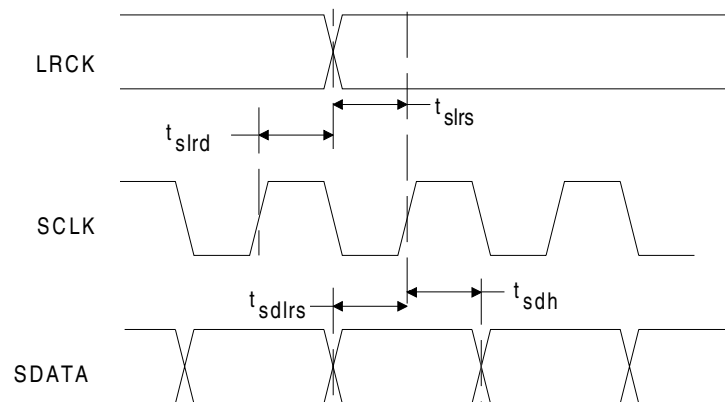
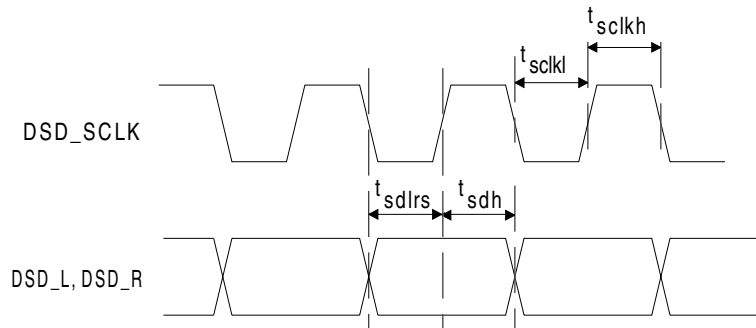

Figure 36. Serial Mode Input Timing

SWITCHING SPECIFICATIONS - DSD INTERFACE (Logic 0 = AGND; Logic 1 = VL)

| Parameter | Symbol | Min | Max | Unit |
|--|------------|-----|-----|------|
| MCLK Duty Cycle | | 40 | 60 | % |
| DSD_SCLK Pulse Width Low | t_{sckl} | 20 | - | ns |
| DSD_SCLK Pulse Width High | t_{sckh} | 20 | - | ns |
| DSD_SCLK Period | t_{sckw} | 20 | - | ns |
| DSD_L or DSD_R valid to DSD_SCLK rising setup time | t_{sdls} | 20 | - | ns |
| DSD_SCLK rising to DSD_L or DSD_R hold time | t_{sdh} | 20 | - | ns |

Figure 37. Direct Stream Digital - Serial Audio Input Timing

SWITCHING CHARACTERISTICS - CONTROL PORT INTERFACE

(Inputs: logic 0 = AGND, logic 1 = VL)

| Parameter | Symbol | Min | Max | Unit |
|--|------------|-----|-----|---------|
| I²C Mode | | | | |
| SCL Clock Frequency | f_{scl} | - | 100 | kHz |
| RST Rising Edge to Start | t_{irs} | 500 | - | ns |
| Bus Free Time Between Transmissions | t_{buf} | 4.7 | - | μ s |
| Start Condition Hold Time (prior to first clock pulse) | t_{hdst} | 4.0 | - | μ s |
| Clock Low time | t_{low} | 4.7 | - | μ s |
| Clock High Time | t_{high} | 4.0 | - | μ s |
| Setup Time for Repeated Start Condition | t_{sust} | 4.7 | - | μ s |
| SDA Hold Time from SCL Falling (Note 6) | t_{hdd} | 0 | - | μ s |
| SDA Setup time to SCL Rising | t_{sud} | 250 | - | ns |
| Rise Time of Both SDA and SCL Lines | t_r | - | 1 | μ s |
| Fall Time of Both SDA and SCL Lines | t_f | - | 300 | ns |
| Setup Time for Stop Condition | t_{susp} | 4.7 | - | μ s |

Notes: 6. Data must be held for sufficient time to bridge the 300 ns transition time of SCL.

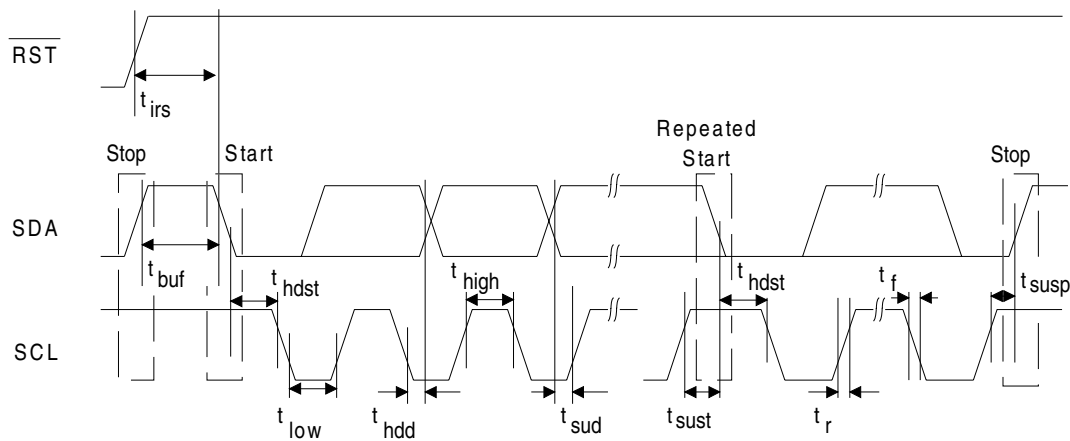
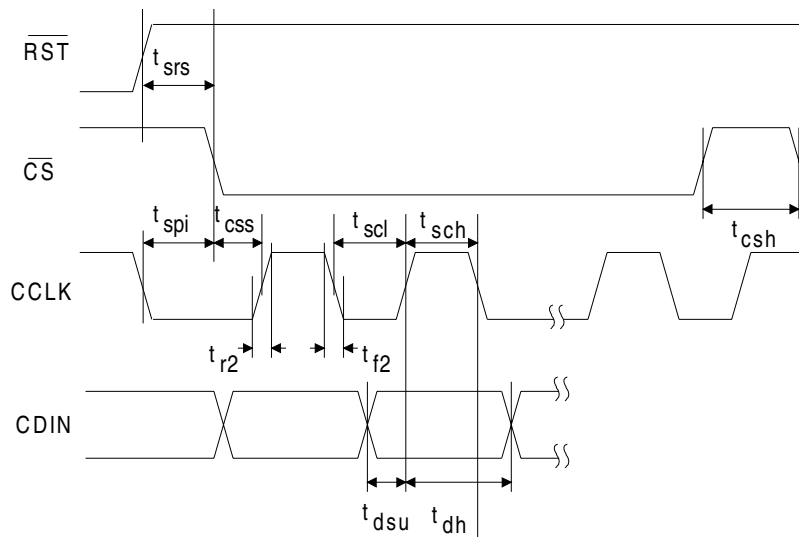

Figure 38. I²C Mode Control Port Timing

SWITCHING CHARACTERISTICS - SPI CONTROL PORT (Inputs: logic 0 = AGND, logic 1 = VL)

| Parameter | Symbol | Min | Max | Unit |
|--|------------|-----|-----|---------|
| SPI Mode | | | | |
| CCLK Clock Frequency | f_{sclk} | - | 6 | MHz |
| RST Rising Edge to CS Falling | t_{srs} | 500 | - | ns |
| CCLK Edge to CS Falling (Note 7) | t_{spi} | 500 | - | ns |
| CS High Time Between Transmissions | t_{csh} | 1.0 | - | μ s |
| CS Falling to CCLK Edge | t_{css} | 20 | - | ns |
| CCLK Low Time | t_{scl} | 82 | - | ns |
| CCLK High Time | t_{sch} | 82 | - | ns |
| CDIN to CCLK Rising Setup Time | t_{dsu} | 40 | - | ns |
| CCLK Rising to DATA Hold Time (Note 8) | t_{dh} | 15 | - | ns |
| Rise Time of CCLK and CDIN (Note 9) | t_{r2} | - | 100 | ns |
| Fall Time of CCLK and CDIN (Note 9) | t_{f2} | - | 100 | ns |

- Notes: 7. t_{spi} only needed before first falling edge of \overline{CS} after \overline{RST} rising edge. $t_{spi} = 0$ at all other times.
 8. Data must be held for sufficient time to bridge the transition time of CCLK.
 9. For $F_{SCK} < 1$ MHz

Figure 39. SPI Control Port Timing

DC ELECTRICAL CHARACTERISTICS (AGND = 0V; all voltages with respect to AGND.)

| Parameter | Symbol | Min | Typ | Max | Units | |
|--|----------------------------------|------|-----------------|-----|------------|----|
| Normal Operation (Note 10) | | | | | | |
| Power Supply Current | All Supplies=5.0V $I_A + I_L$ | - | 26 | 30 | mA | |
| Power Dissipation | | - | 130 | 150 | mW | |
| Power-Down Mode (Note 11) | | | | | | |
| Power Supply Current | All Supplies=5.0V $I_A + I_L$ | - | 300 | - | μ A | |
| Power Dissipation | | - | 1.5 | - | mW | |
| All Modes of Operation | | | | | | |
| Power Supply Rejection Ratio (Note 12) | (1 kHz) (60 Hz) | PSRR | - | 60 | - | dB |
| | | | - | 40 | - | dB |
| Common Mode Voltage | CMOUT | - | 0.48 \cdot VA | - | V | |
| Output Impedance | | - | 250 | - | k Ω | |
| Maximum allowable DC current source/sink | | - | 0.001 | - | mA | |
| Filt+ Nominal Voltage | | - | VA | - | V | |
| Output Impedance | | - | 250 | - | k Ω | |
| Maximum allowable DC current source/sink | | - | 0.001 | - | mA | |
| MUTEC Low-Level Output Voltage | | - | 0 | - | V | |
| MUTEC High-Level Output Voltage | | - | VA | - | V | |
| Maximum MUTEC Drive Current | | - | 3 | - | mA | |

Notes: 10. Normal operation is defined as $\overline{RST} = HI$ with a 997 Hz, 0dBFS input sampled at $F_s = 48kHz$, and open outputs, unless otherwise stated.

11. Power-Down Mode is defined as $\overline{RST} = LO$ with all clocks and data lines held static.

12. Valid with the recommended capacitor values on FILT+ and VQ as shown in Figures 1 and 2.

DIGITAL INPUT CHARACTERISTICS & SPECIFICATIONS (AGND = 0V; all voltages with respect to AGND.)

| Parameters | Symbol | Min | Typ | Max | Units |
|--------------------------|----------|-----|-----|----------|---------|
| Input Leakage Current | I_{in} | - | - | ± 10 | μ A |
| Input Capacitance | | - | 8 | - | pF |
| High-Level Input Voltage | V_{IH} | 70% | - | - | VL |
| Low-Level Input Voltage | V_{IL} | | - | 20% | VL |

THERMAL CHARACTERISTICS AND SPECIFICATIONS

| Parameters | Symbol | Min | Typ | Max | Units |
|---|---------------|-----|-----|-----|------------------|
| Package Thermal Resistance | CS4392-KS | - | 68 | - | $^{\circ}C/Watt$ |
| | CS4392-KZ/KZZ | - | 72 | - | $^{\circ}C/Watt$ |
| Ambient Operating Temperature (Power Applied) | T_A | -10 | - | +70 | $^{\circ}C$ |

RECOMMENDED OPERATING SPECIFICATIONS (AGND = 0V; all voltages with respect to AGND.)

| Parameters | Symbol | Min | Typ | Max | Units |
|-----------------|--------|------|-----|------|-------|
| DC Power Supply | VA | 4.75 | 5.0 | 5.25 | V |
| | VL | 1.8 | - | VA | V |

ABSOLUTE MAXIMUM RATINGS (AGND = 0 V; all voltages with respect to ground.)

| Parameters | Symbol | Min | Max | Units |
|---|-----------|------|----------|-------|
| DC Power Supply | VA | -0.3 | 6.0 | V |
| | VL | -0.3 | VA | V |
| Input Current, Any Pin Except Supplies | I_{in} | - | ± 10 | mA |
| Digital Input Voltage | V_{IND} | -0.3 | VL+0.4 | V |
| Ambient Operating Temperature (power applied) | T_A | -55 | 125 | °C |
| Storage Temperature | T_{stg} | -65 | 150 | °C |

WARNING: Operation at or beyond these limits may result in permanent damage to the device. Normal operation is not guaranteed at these extremes.

8. PARAMETER DEFINITIONS

Total Harmonic Distortion + Noise (THD+N)

The ratio of the rms value of the signal to the rms sum of all other spectral components over the specified bandwidth (typically 10Hz to 20kHz), including distortion components. Expressed in decibels.

Dynamic Range

The ratio of the full scale rms value of the signal to the rms sum of all other spectral components over the specified bandwidth. Dynamic range is a signal-to-noise measurement over the specified bandwidth made with a -60 dBFS signal. 60 dB is then added to the resulting measurement to refer the measurement to full scale. This technique ensures that the distortion components are below the noise level and do not effect the measurement. This measurement technique has been accepted by the Audio Engineering Society, AES17-1991, and the Electronic Industries Association of Japan, EIAJ CP-307.

Interchannel Isolation

A measure of crosstalk between the left and right channels. Measured for each channel at the converter's output with all zeros to the input under test and a full-scale signal applied to the other channel. Units in decibels.

Interchannel Gain Mismatch

The gain difference between left and right channels. Units in decibels.

Gain Error

The deviation from the nominal full scale analog output for a full scale digital input.

Gain Drift

The change in gain value with temperature. Units in ppm/°C.

9. REFERENCES

1. CDB4392 Evaluation Board Datasheet
2. "The I²C-Bus Specification: Version 2.1" Philips Semiconductors, January 2000.
<http://www.semiconductors.philips.com>

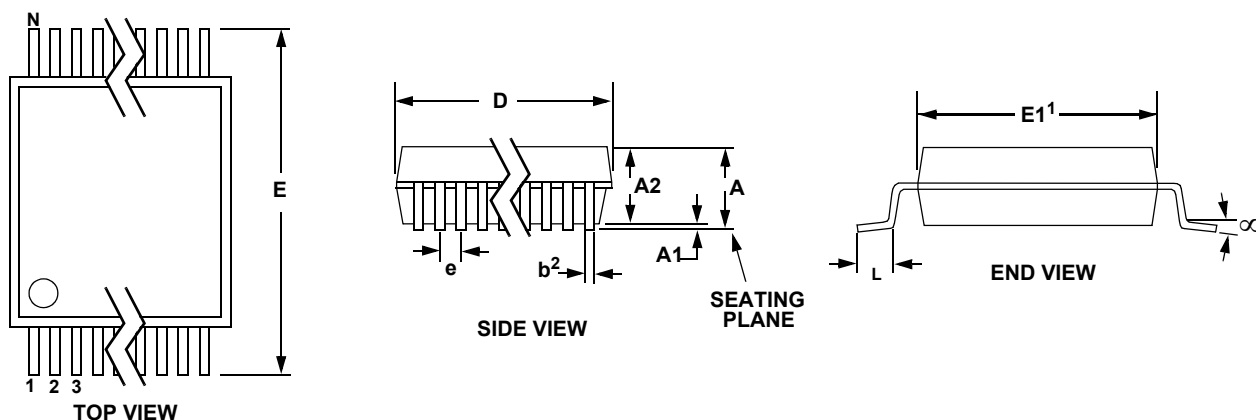
10. PACKAGE DIMENSIONS
20L TSSOP (4.4 mm BODY) PACKAGE DRAWING

| DIM | INCHES | | | MILLIMETERS | | | NOT E |
|-----|---------|--------|-------|-------------|-------|------|-------|
| | MIN | NOM | MAX | MIN | NOM | MAX | |
| A | -- | -- | 0.043 | -- | -- | 1.10 | |
| A1 | 0.002 | 0.004 | 0.006 | 0.05 | -- | 0.15 | |
| A2 | 0.03346 | 0.0354 | 0.037 | 0.85 | 0.90 | 0.95 | |
| b | 0.00748 | 0.0096 | 0.012 | 0.19 | 0.245 | 0.30 | 2,3 |
| D | 0.252 | 0.256 | 0.259 | 6.40 | 6.50 | 6.60 | 1 |
| E | 0.248 | 0.2519 | 0.256 | 6.30 | 6.40 | 6.50 | |
| E1 | 0.169 | 0.1732 | 0.177 | 4.30 | 4.40 | 4.50 | 1 |
| e | -- | -- | 0.026 | -- | -- | 0.65 | |
| L | 0.020 | 0.024 | 0.028 | 0.50 | 0.60 | 0.70 | |
| ∞ | 0° | 4° | 8° | 0° | 4° | 8° | |

JEDEC #: MO-153

Controlling Dimension is Millimeters.

- Notes:
1. "D" and "E1" are reference datums and do not include mold flash or protrusions, but do include mold mismatch and are measured at the parting line, mold flash or protrusions shall not exceed 0.20 mm per side.
 2. Dimension "b" does not include dambar protrusion/intrusion. Allowable dambar protrusion shall be 0.13 mm total in excess of "b" dimension at maximum material condition. Dambar intrusion shall not reduce dimension "b" by more than 0.07 mm at least material condition.
 3. These dimensions apply to the flat section of the lead between 0.10 and 0.25 mm from lead tips.

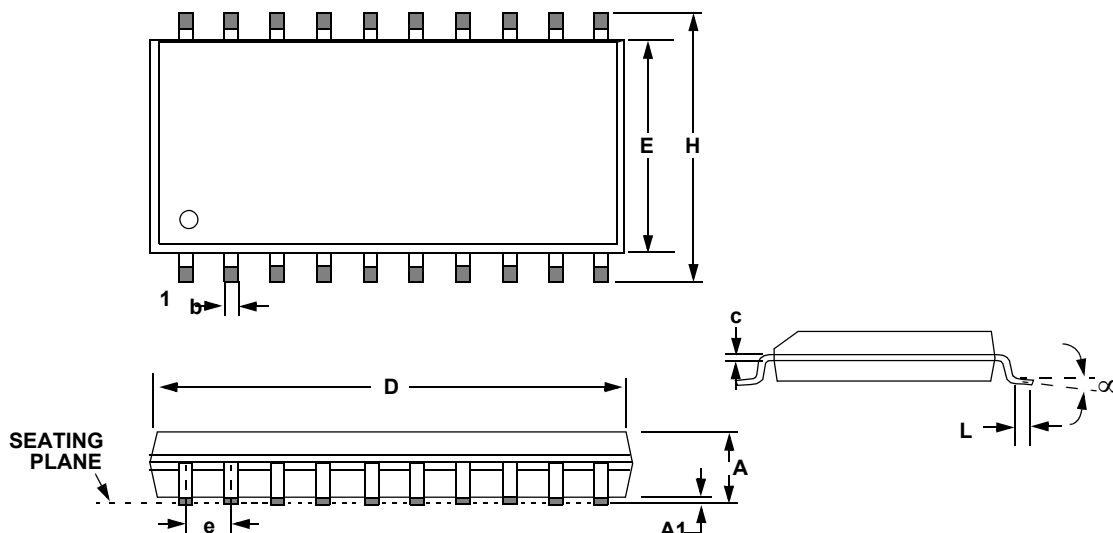
PACKAGE DIMENSIONS(cont.).
20L SOIC (300 MIL BODY) PACKAGE DRAWING

| DIM | INCHES | | | MILLIMETERS | | |
|----------|--------|-------|-------|-------------|-------|-------|
| | MIN | NOM | MAX | MIN | NOM | MAX |
| A | 0.093 | 0.098 | 0.104 | 2.35 | 2.50 | 2.65 |
| A1 | 0.004 | 0.008 | 0.012 | 0.10 | 0.20 | 0.30 |
| b | 0.013 | 0.017 | 0.020 | 0.33 | 0.43 | 0.51 |
| C | 0.009 | 0.011 | 0.013 | 0.23 | 0.28 | 0.32 |
| D | 0.496 | 0.504 | 0.512 | 12.60 | 12.80 | 13.00 |
| E | 0.291 | 0.295 | 0.299 | 7.40 | 7.50 | 7.60 |
| e | 0.040 | 0.050 | 0.060 | 1.02 | 1.27 | 1.52 |
| H | 0.394 | 0.407 | 0.419 | 10.00 | 10.34 | 10.65 |
| L | 0.016 | 0.025 | 0.050 | 0.40 | 0.64 | 1.27 |
| α | 0° | 4° | 8° | 0° | 4° | 8° |

JEDEC #: MS-013

Controlling Dimension is Millimeters

Mouser Electronics

Authorized Distributor

Click to View Pricing, Inventory, Delivery & Lifecycle Information:

[Cirrus Logic:](#)

[CDB4392](#) [CS4392-KZZ](#) [CS4392-KZZR](#)

Компания «Океан Электроники» предлагает заключение долгосрочных отношений при поставках импортных электронных компонентов на взаимовыгодных условиях!

Наши преимущества:

- Поставка оригинальных импортных электронных компонентов напрямую с производств Америки, Европы и Азии, а так же с крупнейших складов мира;
- Широкая линейка поставок активных и пассивных импортных электронных компонентов (более 30 млн. наименований);
- Поставка сложных, дефицитных, либо снятых с производства позиций;
- Оперативные сроки поставки под заказ (от 5 рабочих дней);
- Экспресс доставка в любую точку России;
- Помощь Конструкторского Отдела и консультации квалифицированных инженеров;
- Техническая поддержка проекта, помощь в подборе аналогов, поставка прототипов;
- Поставка электронных компонентов под контролем ВП;
- Система менеджмента качества сертифицирована по Международному стандарту ISO 9001;
- При необходимости вся продукция военного и аэрокосмического назначения проходит испытания и сертификацию в лаборатории (по согласованию с заказчиком);
- Поставка специализированных компонентов военного и аэрокосмического уровня качества (Xilinx, Altera, Analog Devices, Intersil, Interpoint, Microsemi, Actel, Aeroflex, Peregrine, VPT, Syfer, Eurofarad, Texas Instruments, MS Kennedy, Miteq, Cobham, E2V, MA-COM, Hittite, Mini-Circuits, General Dynamics и др.);

Компания «Океан Электроники» является официальным дистрибьютором и эксклюзивным представителем в России одного из крупнейших производителей разъемов военного и аэрокосмического назначения «JONHON», а так же официальным дистрибьютором и эксклюзивным представителем в России производителя высокотехнологичных и надежных решений для передачи СВЧ сигналов «FORSTAR».



JONHON

«JONHON» (основан в 1970 г.)

Разъемы специального, военного и аэрокосмического назначения:

(Применяются в военной, авиационной, аэрокосмической, морской, железнодорожной, горно- и нефтедобывающей отраслях промышленности)

«FORSTAR» (основан в 1998 г.)

ВЧ соединители, коаксиальные кабели, кабельные сборки и микроволновые компоненты:

(Применяются в телекоммуникациях гражданского и специального назначения, в средствах связи, РЛС, а так же военной, авиационной и аэрокосмической отраслях промышленности).



Телефон: 8 (812) 309-75-97 (многоканальный)

Факс: 8 (812) 320-03-32

Электронная почта: ocean@oceanchips.ru

Web: <http://oceanchips.ru/>

Адрес: 198099, г. Санкт-Петербург, ул. Калинина, д. 2, корп. 4, лит. А