

Serial EEPROM Series

High Reliability Series EEPROMs I²C BUS

BR24L□□-W Series, BR24S□□□-W Series

No.09001EDT04

ROHM's series of serial EEPROMs represent the highest level of reliability on the market. A double cell structure provides a failsafe method of data reliability, while a double reset function prevents data miswriting. In addition, gold pads and gold wires are used for internal connections, pushing the boundaries of reliability to the limit.

BR24L□□-W Series assort 1Kbit~64Kbit. BR24S□□□-W Series are possible to operate at high speed in low voltage and assort 8Kbit~256Kbit.

Contents

BR24L□□-W Series

BR24L01A-W, BR24L02-W, BR24L04-W, BR24L08-W,
BR24L16-W, BR24L32-W, BR24L64-W

• • • P2

BR24S□□□-W Series

BR24S08-W, BR24S16-W, BR24S32-W, BR24S64-W,
BR24S128-W, BR24S256-W

• • • P20

Serial EEPROM Series

High Reliability Series

EEPROMs I²C BUS

BR24L□□-W Series

●Description

BR24L□□-W series is a serial EEPROM of I²C BUS interface method.

●Features

- 1) Completely conforming to the world standard I²C BUS. All controls available by 2 ports of serial clock(SCL) and serial data(SDA)
- 2) Other devices than EEPROM can be connected to the same port, saving microcontroller port
- 3) 1.8V~5.5V^{*1} single power source action most suitable for battery use
- 4) Page write mode useful for initial value write at factory shipment
- 5) Highly reliable connection by Au pad and Au wire
- 6) Auto erase and auto end function at data rewrite
- 7) Low current consumption

At write operation (5V) : 1.2mA (Typ.)^{*2}
 At read operation (5V) : 0.2mA (Typ.)
 At standby operation (5V) : 0.1μA (Typ.)

- 8) Write mistake prevention function
Write (write protect) function added
- 9) Write mistake prevention function at low voltage
- 10) SOP8/SOP-J8/SSOP-B8/TSSOP-B8/MSOP8/TSSOP-B8J/VSON008X2030 compact package^{*3}
- 11) Data rewrite up to 1,000,000 times
- 12) Data kept for 40 years
- 13) Noise filter built in SCL / SDA terminal
- 14) Shipment data all address FFh

*1 BR24L02-W, BR24L16-W, BR24L32-W : 1.7~5.5V

*2 BR24L32-W, BR24L64-W : 1.5mA

*3 Refer to following list

●Page write

Number of Pages	8Byte	16Byte	32Byte
Product number	BR24L01A-W BR24L02-W	BR24L04-W BR24L08-W BR24L16-W	BR24L32-W BR24L64-W

●BR24L series

Capacity	Bit format	Type	Power source Voltage	SOP8	SOP-J8	SSOP-B8	TSSOP-B8	MSOP8	TSSOP-B8J	VSON008 X2030
1Kbit	128×8	BR24L01A-W	1.8~5.5V	●	●	●	●	●	●	●
2Kbit	256×8	BR24L02-W	1.7~5.5V	●	●	●	●	●	●	●
4Kbit	512×8	BR24L04-W	1.8~5.5V	●	●	●	●	●	●	●
8Kbit	1K×8	BR24L08-W	1.8~5.5V	●	●	●	●	●	●	●
16Kbit	2K×8	BR24L16-W	1.7~5.5V	●	●	●	●	●	●	
32Kbit	4K×8	BR24L32-W	1.7~5.5V	●	●	●	●			
64Kbit	8K×8	BR24L64-W	1.8~5.5V	●	●					

● Absolute maximum ratings (Ta=25°C)

Parameter	symbol	Limits	Unit
Impressed voltage	Vcc	-0.3~+6.5	V
Permissible dissipation	Pd	450 (SOP8) ^{*1}	mW
		450 (SOP-J8) ^{*2}	
		300 (SSOP-B8) ^{*3}	
		330 (TSSOP-B8) ^{*4}	
		310 (MSOP8) ^{*5}	
		310 (TSSOP-B8J) ^{*6}	
		300 (VSON008X2030) ^{*7}	
Storage temperature range	Tstg	-65~+125	°C
Action temperature range	Topr	-40~+85	°C
Terminal voltage	-	-0.3~Vcc+1.0	V

When using at Ta=25°C or higher, 4.5mW(*1,*2),
3.0mW(*3,*7) 3.3mW(*4), 3.1mW(*5,*6) to be reduced per 1°C

● Memory cell characteristics (Ta=25°C, Vcc=1.8~5.5V) ^{*1}

Parameter	Limits			Unit
	Min.	Typ.	Max.	
Number of data rewrite times ^{*2}	1,000,000	-	-	Times
Data hold years ^{*2}	40	-	-	Years

○ Shipment data all address FFh

*1 BR24L02/16/32-W : 1.7~5.5V

*2 Not 100% TESTED

● Recommended operating conditions

Parameter	Symbol	Limits	Unit
Power source voltage	Vcc	1.8~5.5 ^{*1}	V
Input voltage	VIN	0~Vcc	

*1 BR24L02/16/32-W : 1.7~5.5V

● Electrical characteristics (Unless otherwise specified, Ta=-40~+85°C, Vcc=1.8~5.5V) ^{*1}

Parameter	Symbol	Limits			Unit	Conditions
		Min.	Typ.	Max.		
"HIGH" input voltage 1	VIH1	0.7Vcc	-	Vcc + 1.0 ^{*2}	V	2.5 ≤ Vcc ≤ 5.5V
"LOW" input voltage 1	VIL1	-0.3 ^{*2}	-	0.3 Vcc	V	2.5 ≤ Vcc ≤ 5.5V
"HIGH" input voltage 2	VIH2	0.8Vcc	-	Vcc + 1.0 ^{*2}	V	1.8 ≤ Vcc < 2.5V
"LOW" input voltage 2	VIL2	-0.3 ^{*2}	-	0.2 Vcc	V	1.8 ≤ Vcc < 2.5V
"HIGH" input voltage 3 ^{*3}	VIH3	0.8Vcc	-	Vcc + 1.0	V	1.7 ≤ Vcc < 1.8V
"HIGH" input voltage 3 ^{*4}	VIH3	0.9Vcc	-	Vcc + 1.0	V	1.7 ≤ Vcc < 1.8V
"LOW" input voltage 3 ^{*2}	VIL3	-0.3	-	0.1 Vcc	V	1.7 ≤ Vcc < 1.8V
"LOW" output voltage 1	VOL1	-	-	0.4	V	IoL=3.0mA, 2.5V ≤ Vcc ≤ 5.5V, (SDA)
"LOW" output voltage 2	VOL2	-	-	0.2	V	IoL=0.7mA, 1.7V ≤ Vcc < 2.5V, (SDA)
Input leak current	ILI	-1	-	1	μA	VIN=0V~Vcc
Output leak current	ILO	-1	-	1	μA	VOUT=0V~Vcc, (SDA)
Current consumption at action	ICC1	-	-	2.0 ^{*5} 3.0 ^{*6}	mA	Vcc=5.5V, fSCL=400kHz, tWR=5ms, Byte write, Page write
	ICC2	-	-	0.5	mA	Vcc=5.5V, fSCL=400kHz Random read, current read, sequential read
Standby current	ISB	-	-	2.0	μA	Vcc=5.5V, SDA · SCL=Vcc A0, A1, A2=GND, WP=GND

© Radiation resistance design is not made.

*1 BR24L02/16/32-W : 1.7~5.5V, *2 BR24L16/32-W, *3 BR24L02/16-W, *4 BR24L32-W

*5 BR24L01A/02/04/08/16-W, *6 BR24L32/64-W

● Action timing characteristics (Unless otherwise specified, Ta=-40~+85°C, Vcc=1.8~5.5V)^{*1}

Parameter	Symbol	FAST-MODE 2.5V ≤ Vcc ≤ 5.5V			STANDARD-MODE 1.8V ≤ Vcc ≤ 5.5V			Unit
		Min.	Typ.	Max.	Min.	Typ.	Max.	
SCL frequency	fSCL	-	-	400	-	-	100	kHz
Data clock "HIGH" time	tHIGH	0.6	-	-	4.0	-	-	μs
Data clock "LOW" time	tLOW	1.2	-	-	4.7	-	-	μs
SDA, SCL rise time ^{*2}	tR	-	-	0.3	-	-	1.0	μs
SDA, SCL fall time ^{*2}	tF	-	-	0.3	-	-	0.3	μs
Start condition hold time	tHD:STA	0.6	-	-	4.0	-	-	μs
Start condition setup time	tSU:STA	0.6	-	-	4.7	-	-	μs
Input data hold time	tHD:DAT	0	-	-	0	-	-	ns
Input data setup time	tSU:DAT	100	-	-	250	-	-	ns
Output data delay time	tPD	0.1	-	0.9	0.2	-	3.5	μs
Output data hold time	tDH	0.1	-	-	0.2	-	-	μs
Stop condition setup time	tSU:STO	0.6	-	-	4.7	-	-	μs
Bus release time before transfer start	tBUF	1.2	-	-	4.7	-	-	μs
Internal write cycle time	tWR	-	-	5	-	-	5	ms
Noise removal valid period (SDA, SCL terminal)	tI	-	-	0.1	-	-	0.1	μs
WP hold time	tHD:WP	0	-	-	0	-	-	ns
WP setup time	tSU:WP	0.1	-	-	0.1	-	-	μs
WP valid time	tHIGH:WP	1.0	-	--	1.0	-	-	μs

*1 BR24L02/16/32-W : 1.7~5.5V

*2 Not 100% tested

● FAST-MODE and STANDARD-MODE

FAST-MODE and STANDARD-MODE are of same actions, and mode is changed. They are distinguished by action speeds. 100kHz action is called STANDARD-MODE, and 400kHz action is called FAST-MODE. This action frequency is the maximum action frequency, so 100kHz clock may be used in FAST-MODE. When power source voltage goes down, action at high speed is not carried out, therefore, at Vcc=2.5V~5.5V, 400kHz, namely, action is made in FAST-MODE. (Action is made also in STANDARD-MODE) Vcc=1.8V~2.5V is only action in 100kHz STANDARD-MODE.

● Sync data input / output timing



- Input read at the rise edge of SCL
- Data output in sync with the fall of SCL

Fig.1-(a) Sync data input / output timing



Fig.1-(b) Start-stop bit timing



Fig.1-(c) Write cycle timing



Fig.1-(d) WP timing at write execution



- At write execution, in the area from the D0 taken clock rise of the first DATA(1), to tWR, set WP="LOW".
- By setting WP "HIGH" in the area, write can be cancelled. When it is set WP="HIGH" during tWR, write is forcibly ended, and data of address under access is not guaranteed, therefore write it once again.

Fig.1-(e) WP timing at write cancel

●Block diagram



Fig.2 Block diagram

●Pin assignment and description



Terminal name	Input / output	Function						
		BR24L01A-W	BR24L02-W	BR24L04-W	BR24L08-W	BR24L16-W	BR24L32-W	BR24L64-W
A0	Input	Slave address setting		Not connected			Slave address setting	
A1	Input	Slave address setting			Not connected		Slave address setting	
A2	Input	Slave address setting				Not used	Slave address setting	
GND	-	Reference voltage of all input / output, 0V						
SDA	Input / output	Slave and word address, Serial data input serial data output						
SCL	Input	Serial clock input						
WP	Input	Write protect terminal						
Vcc	-	Connect the power source.						

●Characteristic data (The following values are Typ. ones.)



Fig.3 H input voltage VIH:2



Fig.4 L input voltage VIL:2 (SCL,SDA,WP)



Fig.5 L output voltage VOL:1-IOL1 (VCC=2.5V)

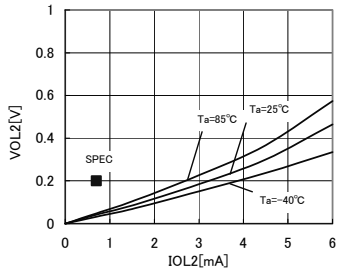

Fig.6 L output voltage VOL:2-IOL2 (VCC=1.8V)

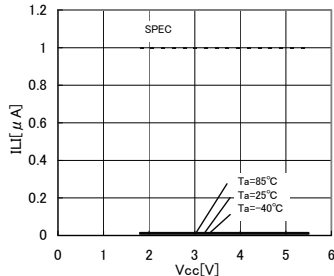

Fig.7 Input leak current IIL (SCL,WP)

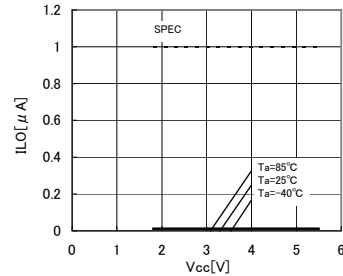

Fig.8 Output leak current ILO(SDA)

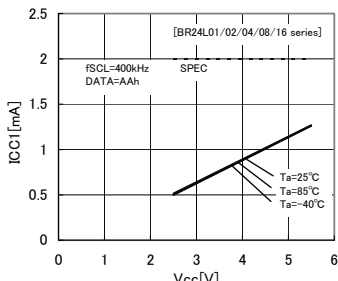

Fig.9 Current consumption at WRITE action ICC1 (fscl=400kHz)

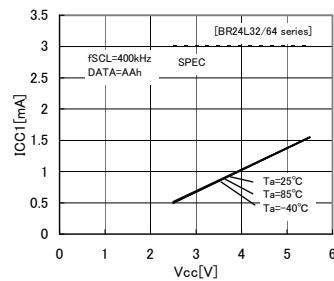

Fig.10 Current consumption at WRITE action ICC1 (fscl=400kHz)

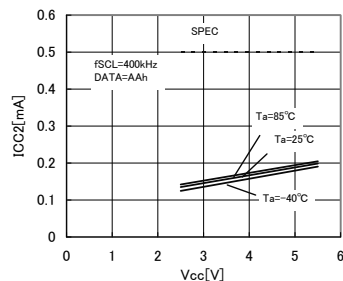

Fig.11 Current consumption at READ action ICC2 (fscl=400kHz)

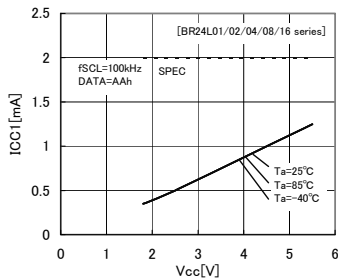

Fig.12 Current consumption at WRITE action ICC1 (fscl=100kHz)

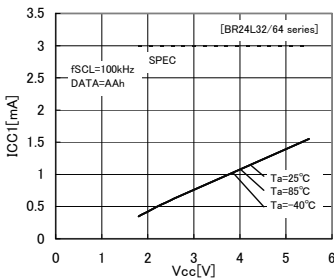

Fig.13 Current consumption at WRITE action ICC1 (fscl=100kHz)

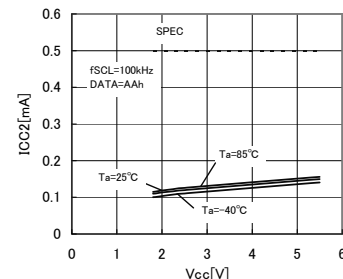

Fig.14 Current consumption at READ action ICC2 (fscl=100kHz)



Fig.15 Standby current ISB



Fig.16 SCL frequency fscl



Fig.17 Data clock "H" time tHIGH

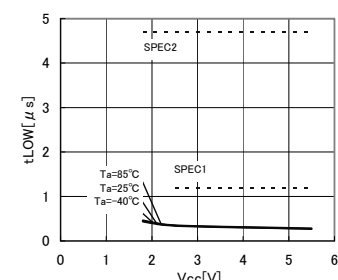

Fig.18 Data clock "L" time tLOW

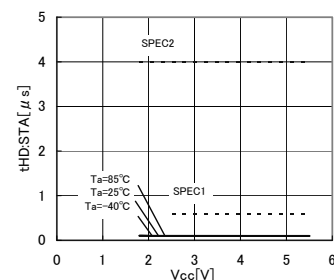

Fig.19 Start condition hold time tHD:STA

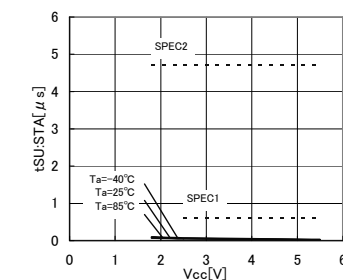

Fig.20 Start condition setup time tSU:STA

●Characteristic data (The following values are Typ. ones).



Fig.21 Input data hold time tHD:DAT(HIGH)



Fig.22 Input data hold time tHD:DAT(LOW)



Fig.23 Input data setup time tSU:DAT(HIGH)



Fig.24 Input data setup time tSU:DAT(LOW)



Fig.25 Output data delay time tPD0



Fig.26 Output data delay time tPD1



Fig.27 Bus release time before transfer start tBUF

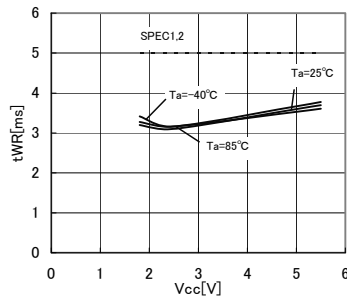

Fig.28 Internal write cycle time tWR



Fig.29 Noise removal valid time tI(SCL H)



Fig.30 Noise removal valid time tI(SCL L)



Fig.31 Noise removal valid time tI(SDA H)



Fig.32 Noise removal valid time tI(SDA L)



Fig.33 WP setup time tSU:WP



Fig.34 WP valid time tHIGH:WP

● I²C BUS communication

○ I²C BUS data communication

I²C BUS data communication starts by start condition input, and ends by stop condition input. Data is always 8bit long, and acknowledge is always required after each byte. I²C BUS carries out data transmission with plural devices connected by 2 communication lines of serial data (SDA) and serial clock (SCL).

Among devices, there are "master" that generates clock and control communication start and end, and "slave" that is controlled by address peculiar to devices. EEPROM becomes "slave". And the device that outputs data to bus during data communication is called "transmitter", and the device that receives data is called "receiver".

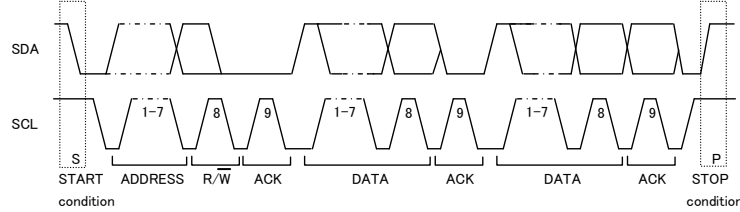

Fig.35 Data transfer timing

○ Start condition (Start bit recognition)

- Before executing each command, start condition (start bit) where SDA goes from 'HIGH' down to 'LOW' when SCL is 'HIGH' is necessary.
- This IC always detects whether SDA and SCL are in start condition (start bit) or not, therefore, unless this condition is satisfied, any command is executed.

○ Stop condition (stop bit recognition)

- Each command can be ended by SDA rising from 'LOW' to 'HIGH' when stop condition (stop bit), namely, SCL is 'HIGH'

○ Acknowledge (ACK) signal

- This acknowledge (ACK) signal is a software rule to show whether data transfer has been made normally or not. In master and slave, the device (μ -COM at slave address input of write command, read command, and this IC at data output of read command) at the transmitter (sending) side releases the bus after output of 8bit data.
- The device (this IC at slave address input of write command, read command, and μ -COM at data output of read command) at the receiver (receiving) side sets SDA 'LOW' during 9 clock cycles, and outputs acknowledge signal (ACK signal) showing that it has received the 8bit data.
- This IC, after recognizing start condition and slave address (8bit), outputs acknowledge signal (ACK signal) 'LOW'.
- Each write action outputs acknowledge signal (ACK signal) 'LOW', at receiving 8bit data (word address and write data).
- Each read action outputs 8bit data (read data), and detects acknowledge signal (ACK signal) 'LOW'.
- When acknowledge signal (ACK signal) is detected, and stop condition is not sent from the master (μ -COM) side, this IC continues data output. When acknowledge signal (ACK signal) is not detected, this IC stops data transfer, and recognizes stop condition (stop bit), and ends read action. And this IC gets in status.

○ Device addressing

- Output slave address after start condition from master.
- The significant 4 bits of slave address are used for recognizing a device type. The device code of this IC is fixed to '1010'.
- Next slave addresses (A2 A1 A0 --- device address) are for selecting devices, and plural ones can be used on a same bus according to the number of device addresses.
- The most insignificant bit ($\overline{R/W}$ --- READ / WRITE) of slave address is used for designating write or read action, and is as shown below.

Setting $\overline{R/W}$ to 0 ----- write (setting 0 to word address setting of random read)
 Setting $\overline{R/W}$ to 1 ----- read

Type	Slave address	Maximum number of connected buses
BR24L01A-W	1 0 1 0 A2 A1 A0 $\overline{R/W}$	8
BR24L02-W	1 0 1 0 A2 A1 A0 $\overline{R/W}$	8
BR24L04-W	1 0 1 0 A2 A1 PS $\overline{R/W}$	4
BR24L08-W	1 0 1 0 A2 P1 P0 $\overline{R/W}$	2
BR24L16-W	1 0 1 0 P2 P1 P0 $\overline{R/W}$	1
BR24L32-W	1 0 1 0 A2 A1 A0 $\overline{R/W}$	8
BR24L64-W	1 0 1 0 A2 A1 A0 $\overline{R/W}$	8

PS, P0~P2 are page select bits.

Note) Up to 4 units BR24L04-W, up to 2 units of BR24L08-W, and one unit of BR24L16-W can be connected.

Device address is set by 'H' and 'L' of each pin of A0, A1, and A2.

●Write Command

○Write cycle

- Arbitrary data is written to EEPROM. When to write only 1 byte, byte write is normally used, and when to write continuous data of 2 bytes or more, simultaneous write is possible by page write cycle. The maximum number of write bytes is specified per device of each capacity. Up to 32 arbitrary bytes can be written. (In the case of BR24L32 / L64-W)

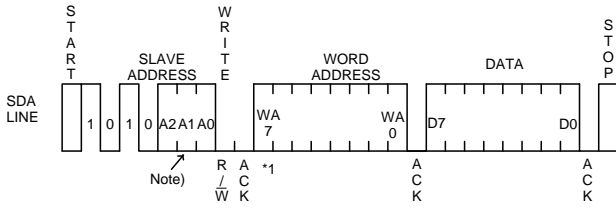

*1 As for WA7, BR24L01A-W becomes Don't care.

Fig.36 Byte write cycle (BR24L01A/02/04/08/16-W)

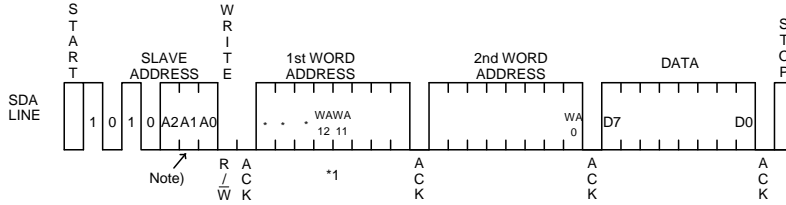

*1 As for WA12, BR24L32-W becomes Don't care.

Fig.37 Byte write cycle (BR24L32/64-W)

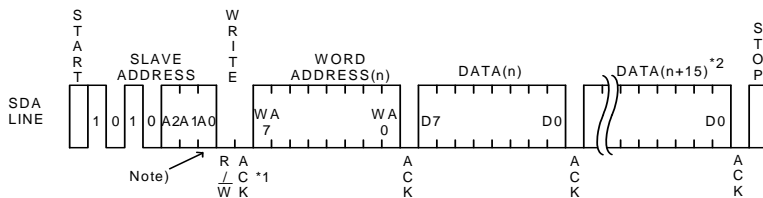

*1 As for WA7, BR24L01A-W becomes Don't care.
*2 As for BR24L01A/02-W becomes (n+7).

Fig.38 Page write cycle (BR24L01A/02/04/08/16-W)

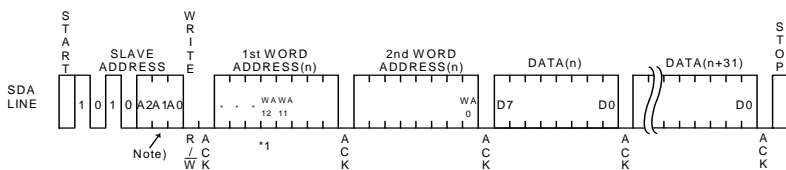

*1 As for WA12, BR24L32-W becomes Don't care.

Fig.39 Page write cycle (BR24L32/64-W)

- Data is written to the address designated by word address (n-th address)
- By issuing stop bit after 8bit data input, write to memory cell inside starts.
- When internal write is started, command is not accepted for tWR (5ms at maximum).
- By page write cycle, the following can be written in bulk :
 - Up to 8 bytes (BR24L01A-W, BR24L02-W)
 - Up to 16bytes (BR24L04-W, BR24L08-W, BR24L16-W)
 - Up to 32bytes (BR24L32-W, BR24L64-W)

And when data of the maximum bytes or higher is sent, data from the first byte is overwritten.

(Refer to "Internal address increment" of "Notes on page write cycle" in P9/32.)

- As for page write cycle of BR24L01A-W and BR24L02-W, after the significant 5 bits (4 significant bits in BR24L01-W) of word address are designated arbitrarily, and as for page write command of BR24L04-W, BR24L08-W, and BR24L16-W, after page select bit (PS) of slave address is designated arbitrarily, by continuing data input of 2 bytes or more, the address of insignificant 4 bits (insignificant 3 bit in BR24L01A-W, and BR24L02-W) is incremented internally, and data up to 16 bytes (up to 8 bytes in BR24L01A-W and BR24L02-W) can be written.
- As for page write cycle of BR24L32-W and BR24L64-W, after the significant 7 bits (in the case of BR24L32-W) of word address, or the significant 8 bits (in the case of BR24L64-W) of word address are designated arbitrarily, by continuing data input of 2 byte or more, the address of insignificant 5 bits is incremented internally, and data up to 32 bytes can be written.

Note)



- *1 In BR24L16-W, A2 becomes P2.
- *2 In BR24L08-W, BR24L16-W, A1 becomes P1.
- *3 In BR24L04-W, A0 becomes PS, and in BR24L08-W and BR24L16-W, A0 becomes P0.

Fig.40 Difference of slave address of each type

○Notes on write cycle continuous input



- *1 BR24L01A-W becomes Don't care.
- *2 BR24L04-W, BR24L08-W, and BR24L16-W become (n+15).
- *3 BR24L32-W and BR24L64-W become (n+31).

Fig.41 Page write cycle

Note)



- *1 In BR24L16-W, A2 becomes P2.
- *2 In BR24L08-W, BR24L16-W, A1 becomes P1.
- *3 In BR24L04-W, A0 becomes PS, and in BR24L08-W and in BR24L16-W, A0 becomes P0.

Fig.42 Difference of each type of slave address

○Notes on page write cycle

List of numbers of page write

Number of Pages	8Byte	16Byte	32Byte
Product number	BR24L01A-W BR24L02-W	BR24L04-W BR24L08-W BR24L16-W	BR24L32-W BR24L64-W

The above numbers are maximum bytes for respective types. Any bytes below these can be written.

In the case BR24L02-W, 1 page=8bytes, but the page write cycle write time is 5ms at maximum for 8byte bulk write. It does not stand 5ms at maximum × 8byte=40ms(Max.).

○Internal address increment

Page write mode (in the case of BR24L02-W)

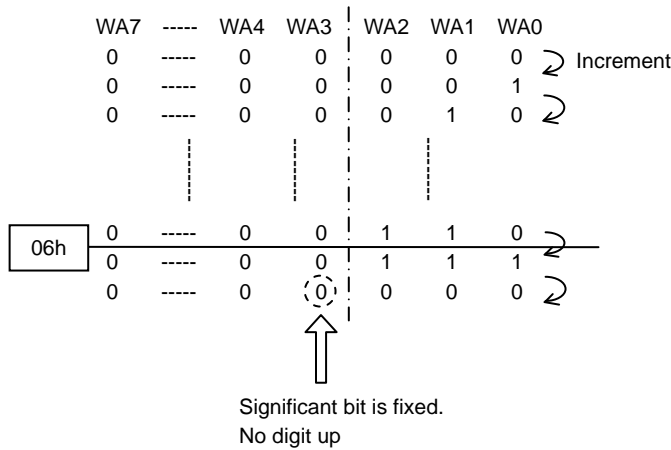

For example, when it is started from address 06h, therefore, increment is made as below,
06h → 07h → 00h → 01h ---, which please note.

* 06h...06 in hexadecimal, therefore, 00000110 becomes a binary number.

○Write protect (WP) terminal

- Write protect (WP) function

When WP terminal is set Vcc (H level), data rewrite of all addresses is prohibited. When it is set GND (L level), data rewrite of all address is enabled. Be sure to connect this terminal to Vcc or GND, or control it to H level or L level.

Do not use it open.

At extremely low voltage at power ON / OFF, by setting the WP terminal 'H', mistake write can be prevented.

During tWR, set the WP terminal always to 'L'. If it is set 'H', write is forcibly terminated.

●Read Command

○Read cycle

Data of EEPROM is read. In read cycle, there are random read cycle and current read cycle. Random read cycle is a command to read data by designating address, and is used generally. Current read cycle is a command to read data of internal address register without designating address, and is used when to verify just after write cycle. In both the read cycles, sequential read cycle is available, and the next address data can be read in succession.



Fig.43 Random read cycle (BR24L01A/02/04/08/16-W)

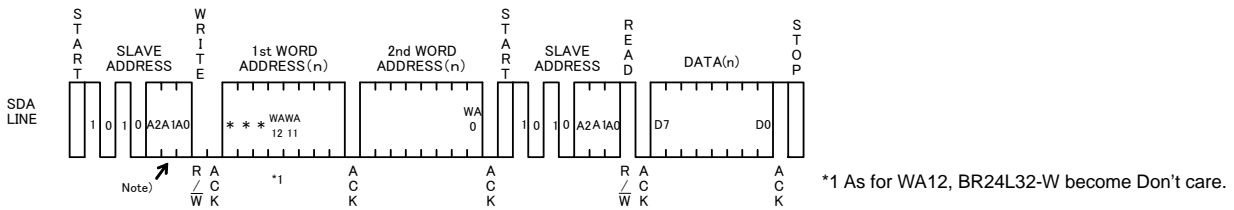

Fig.44 Random read cycle (BR24L32/64 -W)



Fig.45 Current read cycle



Fig.46 Sequential read cycle (in the case of current read cycle)

- In random read cycle, data of designated word address can be read.
- When the command just before current read cycle is random read cycle, current read cycle (each including sequential read cycle), data of incremented last read address (n)-th address, i.e., data of the (n+1)-th address is output.
- When ACK signal 'LOW' after D0 is detected, and stop condition is not sent from master (μ -COM) side, the next address data can be read in succession.
- Read cycle is ended by stop condition where 'H' is input to ACK signal after D0 and SDA signal is started at SCL signal 'H'.
- When 'H' is not input to ACK signal after D0, sequential read gets in, and the next data is output. Therefore, read command cycle cannot be ended. When to end read command cycle, be sure input stop condition to input 'H' to ACK signal after D0, and to start SDA at SCL signal 'H'.
- Sequential read is ended by stop condition where 'H' is input to ACK signal after arbitrary D0 and SDA is started at SCL signal 'H'.

Note)



- *1 In BR24L16-W, A2 becomes P2.
- *2 In BR24L08-W, BR24L16-W, A1 becomes P1.
- *3 In BR24L04-W, A0 becomes PS, and in BR24L08-W and BR24L16-W, A0 becomes P0.

Fig.47 Difference of slave address of each type

● Software reset

Software reset is executed when to avoid malfunction after power on, and to reset during command input. Software reset has several kinds, and 3 kinds of them are shown in the figure below. (Refer to Fig.48(a), Fig.48(b), and Fig.48(c).) In dummy clock input area, release the SDA bus ('H' by pull up). In dummy clock area, ACK output and read data '0' (both 'L' level) may be output from EEPROM, therefore, if 'H' is input forcibly, output may conflict and over current may flow, leading to instantaneous power failure of system power source or influence upon devices.



Fig.48-(a) The case of dummy clock +START+START+ command input



Fig.48-(b) The case of START +9 dummy clocks +START+ command input

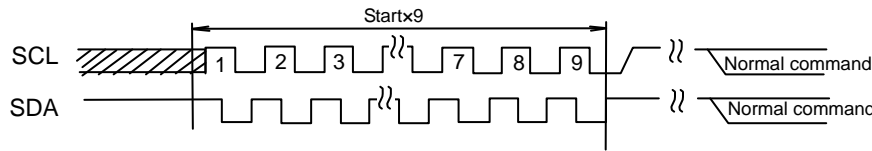

* Start command from START input.

Fig.48-(c) STARTx9+ command input

● Acknowledge polling

During internal write execution, all input commands are ignored, therefore ACK is not sent back. During internal automatic write execution after write cycle input, next command (slave address) is sent, and if the first ACK signal sends back 'L', then it means end of write action, while if it sends back 'H', it means now in writing. By use of acknowledge polling, next command can be executed without waiting for $t_{WR} = 5ms$.

When to write continuously, R/W = 0, when to carry out current read cycle after write, slave address R/W = 1 is sent, and if ACK signal sends back 'L', then execute word address input and data output and so forth.



Fig.49 Case to continuously write by acknowledge polling

●WP valid timing (write cancel)

WP is usually fixed to 'H' or 'L', but when WP is used to cancel write cycle and so forth, pay attention to the following WP valid timing. During write cycle execution, in cancel valid area, by setting WP='H', write cycle can be cancelled. In both byte write cycle and page write cycle, the area from the first start condition of command to the rise of clock to taken in D0 of data(in page write cycle, the first byte data) is cancel invalid area.

WP input in this area becomes Don't care. Set the setup time to rise of D0 taken SCL 100ns or more. The area from the rise of SCL to take in D0 to the end of internal automatic write (tWR) is cancel valid area. And, when it is set WP='H' during tWR, write is ended forcibly, data of address under access is not guaranteed, therefore, write it once again. (Refer to Fig.50.) After execution of forced end by WP, standby status gets in, so there is no need to wait for tWR (5ms at maximum).



Fig.50 WP valid timing

●Command cancel by start condition and stop condition

During command input, by continuously inputting start condition and stop condition, command can be cancelled. (Refer to Fig. 51)

However, in ACK output area and during data read, SDA bus may output 'L', and in this case, start condition and stop condition cannot be input, so reset is not available. Therefore, execute software reset. And when command is cancelled by start, stop condition, during random read cycle, sequential read cycle, or current read cycle, internal setting address is not determined, therefore, it is not possible to carry out current read cycle in succession. When to carry out read cycle in succession, carry out random read cycle.



Fig.51 Case of cancel by start, stop condition during slave address input

● I/O peripheral circuit

○ Pull up resistance of SDA terminal

SDA is NMOS open drain, so requires pull up resistance. As for this resistance value (R_{PU}), select an appropriate value to this resistance value from microcontroller V_{IL} , I_L , and V_{OL} - I_{OL} characteristics of this IC. If R_{PU} is large, action frequency is limited. The smaller the R_{PU} , the larger the consumption current at action.

○ Maximum value of R_{PU}

The maximum value of R_{PU} is determined by the following factors.

(1) SDA rise time to be determined by the capacitance (CBUS) of bus line of R_{PU} and SDA should be t_R or below. And AC timing should be satisfied even when SDA rise time is late.

(2) The bus electric potential (A) to be determined by input leak total (I_L) of device connected to bus at output of 'H' to SDA bus and R_{PU} should sufficiently secure the input 'H' level (V_{IH}) of microcontroller and EEPROM including recommended noise margin $0.2V_{CC}$.

$$V_{CC} - I_L R_{PU} - 0.2V_{CC} \geq V_{IH}$$

$$\therefore R_{PU} = \frac{0.8V_{CC} - V_{IH}}{I_L}$$

Ex.) When $V_{CC} = 3V$, $I_L = 10\mu A$, $V_{IH} = 0.7 V_{CC}$, from (2)

$$R_{PU} \leq \frac{0.8 \times 3 - 0.7 \times 3}{10 \times 10^{-6}} \\ \leq 300 \text{ [k}\Omega\text{]}$$



Fig.52 I/O circuit diagram

○ Minimum value of R_{PU}

The minimum value of R_{PU} is determined by the following factors.

(1) When IC outputs LOW, it should be satisfied that $V_{OLMAX} = 0.4V$ and $I_{OLMAX} = 3mA$.

$$\frac{V_{CC} - V_{OL}}{R_{PU}} \leq I_{OL} \quad \therefore R_{PU} \leq \frac{V_{CC} - V_{OL}}{I_{OL}}$$

(2) $V_{OLMAX} = 0.4V$ should secure the input 'L' level (V_{IL}) of microcontroller and EEPROM including recommended noise margin $0.1V_{CC}$.

$$V_{OLMAX} \leq V_{IL} - 0.1 V_{CC}$$

Ex.) When $V_{CC} = 3V$, $V_{OL} = 0.4V$, $I_{OL} = 3mA$, microcontroller, EEPROM $V_{IL} = 0.3V_{CC}$ from (1)

$$R_{PU} \geq \frac{3 - 0.4}{3 \times 10^{-3}} \\ \geq 867 \text{ [}\Omega\text{]}$$

And

$$V_{OL} = 0.4 \text{ [V]}$$

$$V_{IL} = 0.3 \times 3$$

$$= 0.9 \text{ [V]}$$

Therefore, the condition (2) is satisfied.

○ Pull up resistance of SCL terminal

When SCL control is made at CMOS output port, there is no need, but in the case there is timing where SCL becomes 'Hi-Z', add a pull up resistance. As for the pull up resistance, one of several k Ω ~ several ten k Ω is recommended in consideration of drive performance of output port of microcontroller.

● A0, A1, A2, WP process

○ Process of device address terminals (A0, A1, A2)

Check whether the set device address coincides with device address input sent from the master side or not, and select one among plural devices connected to a same bus. Connect this terminal to pull up or pull down, or V_{CC} or GND. And, pins (N, C, PIN) not used as device address may be set to any of 'H', 'L', and 'Hi-Z'.

Types with N.C. PIN	BR24L16/F/FJ/FV/FVT/FVM/FVJ-W	A0, A1, A2
	BR24L08/F/FJ/FV/FVT/FVM/FVJ/NUX-W	A0, A1
	BR24L04/F/FJ/FV/FVT/FVM/FVJ/NUX-W	A0

○ Process of WP terminal

WP terminal is the terminal that prohibits and permits write in hardware manner. In 'H' status, only READ is available and WRITE of all address is prohibited. In the case of 'L', both are available. In the case of use it as an ROM, it is recommended to connect it to pull up or V_{CC} . In the case to use both READ and WRITE, control WP terminal or connect it to pull down or GND.

●Cautions on microcontroller connection

○Rs

In I²C BUS, it is recommended that SDA port is of open drain input/output. However, when to use CMOS input / output of tri state to SDA port, insert a series resistance R_s between the pull up resistance R_{pu} and the SDA terminal of EEPROM. This is controls over current that occurs when PMOS of the microcontroller and NMOS of EEPROM are turned ON simultaneously. R_s also plays the role of protection of SDA terminal against surge. Therefore, even when SDA port is open drain input/output, R_s can be used.

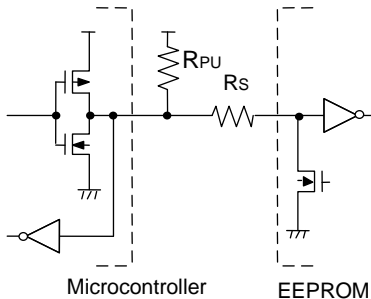
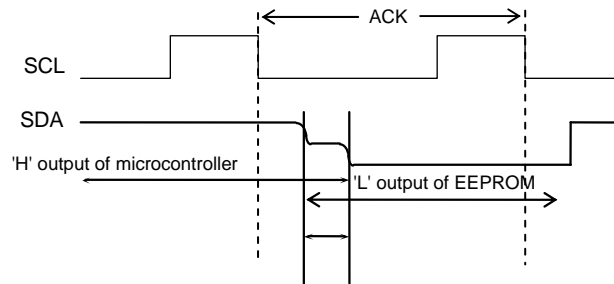

Fig.53 I/O circuit diagram



Over current flows to SDA line by 'H' output of microcontroller and 'L' output of EEPROM.

Fig.54 Input / output collision timing

○Maximum value of R_s

The maximum value of R_s is determined by the following relations.

(1) SDA rise time to be determined by the capacity (C_{BUS}) of bus line of R_{pu} and SDA should be t_R or below.

And AC timing should be satisfied even when SDA rise time is late.

(2) The bus electric potential (A) to be determined by R_{pu} and R_s the moment when EEPROM outputs 'L' to SDA bus should sufficiently secure the input 'L' level (V_{IL}) of microcontroller including recommended noise margin 0.1V_{CC}.

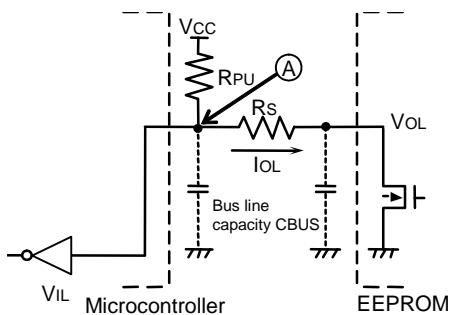

Fig.55 I/O circuit diagram

$$\frac{(V_{CC}-V_{OL}) \times R_s}{R_{PU}+R_s} + V_{OL} + 0.1V_{CC} \leq V_{IL}$$

$$\therefore R_s \leq \frac{V_{IL}-V_{OL}-0.1V_{CC}}{1.1V_{CC}-V_{IL}} \times R_{PU}$$

Example) When V_{CC}=3V, V_{IL}=0.3V_{CC}, V_{OL}=0.4V, R_{PU}=20kΩ

$$\begin{aligned} \text{from(2), } R_s &\leq \frac{0.3 \times 3 - 0.4 - 0.1 \times 3}{1.1 \times 3 - 0.3 \times 3} \times 20 \times 10^3 \\ &\leq 1.67 \text{ [k}\Omega\text{]} \end{aligned}$$

○Minimum value of R_s

The minimum value of R_s is determined by over current at bus collision. When over current flows, noises in power source line, and instantaneous power failure of power source may occur. When allowable over current is defined as I, the following relation must be satisfied. Determine the allowable current in consideration of impedance of power source line in set and so forth. Set the over current to EEPROM 10mA or below.

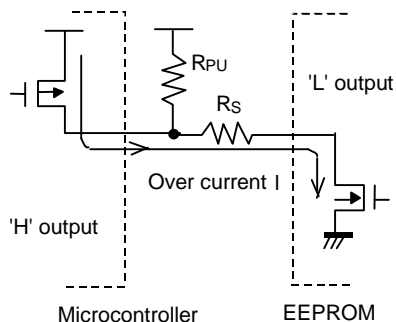

Fig.56 I/O circuit diagram

$$\frac{V_{CC}}{R_s} \leq I$$

$$\therefore R_s \geq \frac{V_{CC}}{I}$$

Example) When V_{CC}=3V, I=10mA

$$\begin{aligned} R_s &\geq \frac{3}{10 \times 10^{-3}} \\ &\geq 300 \text{ [}\Omega\text{]} \end{aligned}$$

● I²C BUS input / output circuit

○ Input (A0, A2, SCL)

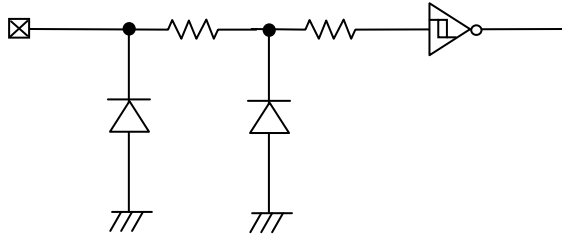

Fig.57 Input pin circuit diagram

○ Input / output (SDA)



Fig.58 Input / output pin circuit diagram

○ Input (A1, WP)



Fig.59 Input pin circuit diagram

● Notes on power ON

At power on, in IC internal circuit and set, V_{CC} rises through unstable low voltage area, and IC inside is not completely reset, and malfunction may occur. To prevent this, functions of POR circuit and LVCC circuit are equipped. To assure the action, observe the following conditions at power on.

1. Set SDA = 'H' and SCL = 'L' or 'H'
2. Start power source so as to satisfy the recommended conditions of t_R, t_{OFF}, and V_{bot} for operating POR circuit.



Fig.60 Rise waveform diagram

Recommended conditions of t_R, t_{OFF}, V_{bot}

t _R	t _{OFF}	V _{bot}
10ms or below	10ms or longer	0.3V or below
100ms or below	10ms or longer	0.2V or below

3. Set SDA and SCL so as not to become 'Hi-Z'.

When the above conditions 1 and 2 cannot be observed, take the following countermeasures.

a) In the case when the above condition 1 cannot be observed. When SDA becomes 'L' at power on .

→Control SCL and SDA as shown below, to make SCL and SDA, 'H' and 'H'.



Fig.61 When SCL='H' and SDA='L'



Fig.62 When SCL='L' and SDA='L'

b) In the case when the above condition 2 cannot be observed.

→After power source becomes stable, execute software reset(P11).

c) In the case when the above conditions 1 and 2 cannot be observed.

→Carry out a), and then carry out b).

●Low voltage malfunction prevention function

LVCC circuit prevents data rewrite action at low power, and prevents wrong write. At LVCC voltage (Typ. =1.2V) or below, it prevent data rewrite.

●Vcc noise countermeasures

○Bypass capacitor

When noise or surge gets in the power source line, malfunction may occur, therefore, for removing these, it is recommended to attach a by pass capacitor (0.1μF) between IC Vcc and GND. At that moment, attach it as close to IC as possible.

And, it is also recommended to attach a bypass capacitor between board Vcc and GND.

●Notes for use

- (1) Described numeric values and data are design representative values, and the values are not guaranteed.
- (2) We believe that application circuit examples are recommendable, however, in actual use, confirm characteristics further sufficiently. In the case of use by changing the fixed number of external parts, make your decision with sufficient margin in consideration of static characteristics and transition characteristics and fluctuations of external parts and our LSI.
- (3) Absolute maximum ratings
If the absolute maximum ratings such as impressed voltage and action temperature range and so forth are exceeded, LSI may be destructed. Do not impress voltage and temperature exceeding the absolute maximum ratings. In the case of fear exceeding the absolute maximum ratings, take physical safety countermeasures such as fuses, and see to it that conditions exceeding the absolute maximum ratings should not be impressed to LSI.
- (4) GND electric potential
Set the voltage of GND terminal lowest at any action condition. Make sure that each terminal voltage is lower than that of GND terminal.
- (5) Terminal design
In consideration of permissible loss in actual use condition, carry out heat design with sufficient margin.
- (6) Terminal to terminal shortcircuit and wrong packaging
When to package LSI onto a board, pay sufficient attention to LSI direction and displacement. Wrong packaging may destruct LSI. And in the case of shortcircuit between LSI terminals and terminals and power source, terminal and GND owing to foreign matter, LSI may be destructed.
- (7) Use in a strong electromagnetic field may cause malfunction, therefore, evaluate design sufficiently.

Serial EEPROM Series

High Reliability Series EEPROMs I²C BUS

BR24S□□□-W Series

●Description

BR24S□□□-W series is a serial EEPROM of I2C BUS interface method.

●Features

- 1) Completely conforming to the world standard I²C BUS. All controls available by 2 ports of serial clock (SCL) and serial data (SDA)
- 2) Other devices than EEPROM can be connected to the same port, saving microcontroller port.
- 3) 1.7~5.5V single power source action most suitable for battery use.
- 4) FAST MODE 400kHz at 1.7~5.5V
- 5) Page write mode useful for initial value write at factory shipment.
- 6) Highly reliable connection by Au pad and Au wire.
- 7) Auto erase and auto end function at data rewrite.
- 8) Low current consumption
 - At write operation (5V) : 0.5mA (Typ.)
 - At read operation (5V) : 0.2mA (Typ.)
 - At standby operation (5V) : 0.1μA (Typ.)
- 9) Write mistake prevention function
 - Write (write protect) function added
 - Write mistake prevention function at low voltage
- 10) SOP8/SOP-J8/SSOP-B8/TSSOP-B8/MSOP8/TSSOP-B8J/VSON008X2030 compact package
- 11) Data rewrite up to 1,000,000 times
- 12) Data kept for 40 years
- 13) Noise filter built in SCL / SDA terminal
- 14) Shipment data all address FFh

●Page write

Number of pages	16Byte	32Byte	64Byte
Product number	BR24S08-W BR24S16-W	BR24S32-W BR24S64-W	BR24S128-W BR24S256-W

●BR24S series

Capacity	Bit format	Type	Power source voltage	SOP8	SOP-J8	SSOP-B8	TSSOP-B8	MSOP8	TSSOP-B8J	VSON008 X2030
8Kbit	1Kx8	BR24S08-W	1.7~5.5V	●	●	●	●	●	●	●
16Kbit	2Kx8	BR24S16-W	1.7~5.5V	●	●	●	●	●	●	●
32Kbit	4Kx8	BR24S32-W	1.7~5.5V	●	●	●	●	●	●	●
64Kbit	8Kx8	BR24S64-W	1.7~5.5V	●	●	●	●	●	●	
128Kbit	16Kx8	BR24S128-W	1.7~5.5V	●	●	●	●			
256Kbit	32Kx8	BR24S256-W	1.7~5.5V	●	●					

● Absolute maximum ratings (Ta=25°C)

Parameter	symbol	Limits	Unit
Impressed voltage	Vcc	-0.3~+6.5	V
Permissible dissipation	Pd	450 (SOP8) ^{*1}	mW
		450 (SOP-J8) ^{*2}	
		300 (SSOP-B8) ^{*3}	
		330 (TSSOP-B8) ^{*4}	
		310 (MSOP8) ^{*5}	
		310 (TSSOP-B8J) ^{*6}	
300 (VSON008X2030) ^{*7}			
Storage temperature range	Tstg	-65~+125	°C
Action temperature range	Topr	-40~+85	°C
Terminal voltage	-	-0.3~Vcc+1.0	V

*When using at Ta=25°C or higher, 4.5mW(*1,*2), 3.0mW(*3,*7) 3.3mW(*4), 3.1mW(*5,*6) to be reduced per 1°C

● Memory cell characteristics (Ta=25°C, Vcc=1.7~5.5V)

Parameter	Limits			Unit
	Min.	Typ.	Max.	
Number of data rewrite times ^{*1}	1,000,000	-	-	Times
Data hold years ^{*1}	40	-	-	Years

*1 Not 100% TESTED

● Recommended operating conditions

Parameter	Symbol	Limits	Unit
Power source voltage	Vcc	1.7~5.5	V
Input voltage	VIN	0~Vcc	

● Electrical characteristics

(Unless otherwise specified, T=-40~+85°C, Vcc=1.7~5.5V)

Parameter	Symbol	Limits			Unit	Condition
		Min	Typ.	Max.		
"H" Input Voltage1	VIH1	0.7Vcc	-	Vcc+1.0	V	
"L" Input Voltage1	VIL1	-0.3	-	0.3Vcc	V	
"L" Output Voltage1	VOL1	-	-	0.4	V	IOL=3.0mA, 2.5V ≤ Vcc ≤ 5.5V (SDA)
"L" Output Voltage2	VOL2	-	-	0.2	V	IOL=0.7mA, 1.7V ≤ Vcc ≤ 2.5V (SDA)
Input Leakage Current	ILI	-1	-	1	μA	VIN=0~Vcc
Output Leakage Current	ILO	-1	-	1	μA	VOUT=0~Vcc (SDA)
Current consumption at action	ICC1	-	-	2.0	mA	Vcc=5.5V, fSCL=400kHz, tWR=5ms Byte Write, Page Write BR24S08/16/32/64-W
		-	-	2.5		Vcc=5.5V, fSCL=400kHz, tWR=5ms Byte Write, Page Write BR24S128/256-W
	ICC2	-	-	0.5	mA	Vcc=5.5V, fSCL=400kHz Random read, Current read, Sequential read
Standby Current	ISB	-	-	2.0	μA	Vcc=5.5V, SDA · SCL=Vcc A0, A1, A2=GND, WP=GND

○Radiation resistance design is not made.

● Action timing characteristics

(Unless otherwise specified, T=-40~+85°C, Vcc=1.7~5.5V)

Parameter	Symbol	Limits			Unit
		Min.	Typ.	Max.	
SCL Frequency	fSCL	-	-	400	kHz
Data clock "High" time	tHIGH	0.6	-	-	μs
Data clock "Low" time	tLOW	1.2	-	-	μs
SDA, SCL rise time *1	tR	-	-	0.3	μs
SDA, SCL fall time *1	tF	-	-	0.3	μs
Start condition hold time	tHD:STA	0.6	-	-	μs
Start condition setup time	tSU:STA	0.6	-	-	μs
Input data hold time	tHD:DAT	0	-	-	ns
Input data setup time	tSU:DAT	100	-	-	ns
Output data delay time	tPD	0.1	-	0.9	μs
Output data hold time	tDH	0.1	-	-	μs
Stop condition data setup time	tSU:STO	0.6	-	-	μs
Bus release time before transfer start	tBUF	1.2	-	-	μs
Internal write cycle time	tWR	-	-	5	ms
Noise removal valid period (SDA, SCL terminal)	tI	-	-	0.1	μs
WP hold time	tHD:WP	0	-	-	ns
WP setup time	tSU:WP	0.1	-	-	μs
WP valid time	tHIGH:WP	1.0	-	-	μs

*1 : Not 100% TESTED

● Sync data input/output timing



O Input read at the rise edge of SCL
 O Data output in sync with the fall of SCL

Fig.1-(a) Sync data input / output timing



Fig.1-(b) Start - stop bit timing



Fig.1-(c) Write cycle timing



Fig.1-(d) WP timing at write execution



O At write execution, in the area from the D0 taken clock rise of the first DATA(1), to tWR, set WP= 'LOW'.
 O By setting WP "HIGH" in the area, write can be cancelled.
 When it is set WP = 'HIGH' during tWR, write is forcibly ended, and data of address under access is not guaranteed, therefore write it once again.

Fig.1-(e) WP timing at write cancel

● Block diagram

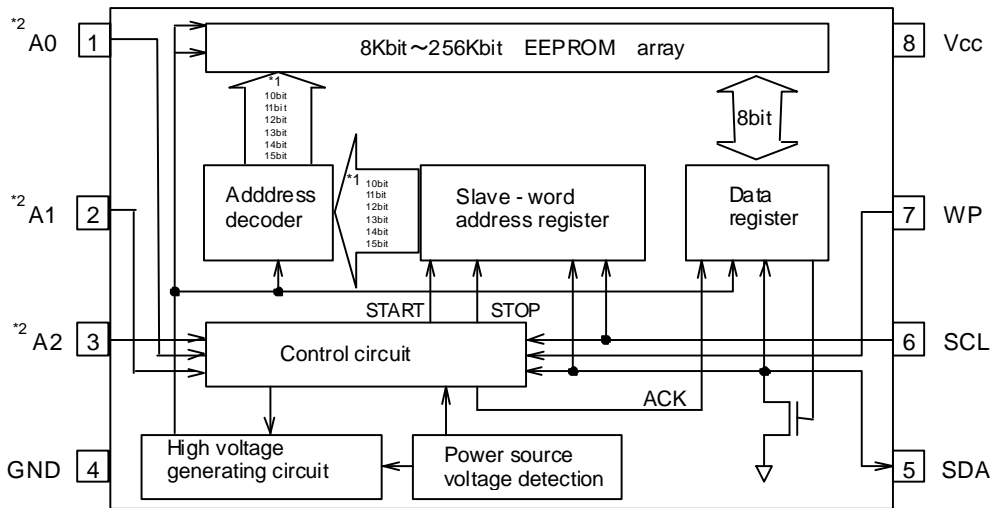

*1 10bit: BR24S08-W
 11bit: BR24S16-W
 12bit: BR24S32-W
 13bit: BR24S64-W
 14bit: BR24S128-W
 15bit: BR24S256-W
 *2 A0, A1= Don't use: BR24S08-W
 A0, A1, A2= Don't use: BR24S16-W

Fig.2 Block diagram

●Pin assignment and description



Terminal name	Input/Output	Function		
		BR24S08-W	BR24S16-W	BR24S32/64/128/256-W
A0	Input	Don't use	Don't use	Slave address setting
A1	Input	Don't use	Don't use	Slave address setting
A2	Input	Slave address setting	Don't use	Slave address setting
GND	-	Reference voltage of all input / output, 0V.		
SDA	Input / Output	Slave and word address, Serial data input serial data output		
SCL	Input	Serial clock input		
WP	Input	Write protect terminal		
Vcc	-	Connect the power source.		

●Characteristic data (The following values are Typ. ones.)



Fig.3 'H' input voltage V_{IH} (A0,A1,A2,SCL,SDA,WP)



Fig.4 'L' input voltage V_{IL} (A0,A1,A2,SCL,SDA,WP)



Fig.5 'L' output voltage $V_{OL-L}(V_{CC}=1.7V)$

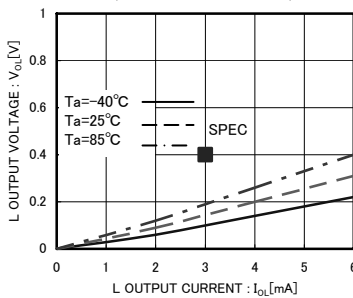

Fig.6 'L' output voltage $V_{OL}(V_{CC}=2.5V)$



Fig.7 Input leak current I_{IL} (A0,A1,A2,SCL,WP)



Fig.8 Output leak current $I_{LO}(SDA)$

●Characteristic data (The following values are Typ. ones.)



Fig.9 Current consumption at WRITE operation I_{cc1} (f_{SCL}=400kHz BR24S16/32/64-W)



Fig.10 Current consumption at WRITE operation I_{cc1} (f_{SCL}=400kHz BR24S128/256-W)



Fig.11 Current consumption at READ operation I_{cc2} (f_{SCL}=400kHz)



Fig.12 Standby operation I_{sB}



Fig.13 SCL frequency f_{SCL}



Fig.14 Data clock High Period t_{HIGH}



Fig.15 Data clock Low Period t_{LOW}



Fig.16 Start Condition Hold Time t_{HD:STA}



Fig.17 Start Condition Setup Time t_{SU:STA}



Fig.18 Input Data Hold Time t_{HD:DAT(HIGH)}



Fig.19 Input Data Hold Time t_{HD:DAT(LOW)}



Fig.20 Input Data Setup Time t_{SU:DAT(HIGH)}



Fig.21 Input Data setup time t_{SU:DAT(LOW)}



Fig.22 'L' Data output delay time t_{PD0}



Fig.23 'H' Data output delay time t_{PD1}

●Characteristic data (The following values are Typ. ones.)



Fig.24 BUS open time before transmission t_{BUF}



Fig.25 Internal writing cycle time t_{WR}



Fig.26 Noise reduction effective time t_i (SCL H)



Fig.27 Noise reduction effective time t_i (SCL L)



Fig.28 Noise reduction effective time t_i (SDA H)



Fig.29 Noise reduction effective time t_i (SDA L)



Fig.30 WP setup time $t_{SU:WP}$



Fig.31 WP effective time $t_{HIGH:WP}$

● I²C BUS communication

○ I²C BUS data communication

I²C BUS data communication starts by start condition input, and ends by stop condition input. Data is always 8bit long, and acknowledge is always required after each byte.

I²C BUS carries out data transmission with plural devices connected by 2 communication lines of serial data (SDA) and serial clock (SCL).

Among devices, there are "master" that generates clock and control communication start and end, and "slave" that is controlled by addresses peculiar to devices.

EEPROM becomes "slave". And the device that outputs data to bus during data communication is called "transmitter", and the device that receives data is called "receiver".

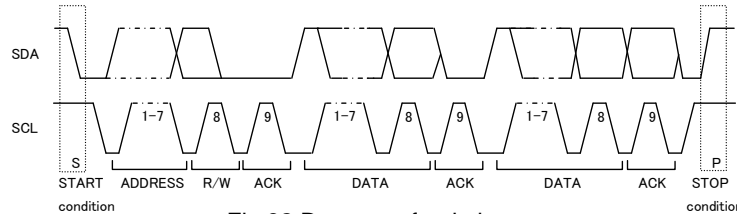

Fig.32 Data transfer timing

○ Start condition (start bit recognition)

- Before executing each command, start condition (start bit) where SDA goes from 'HIGH' down to 'LOW' when SCL is 'HIGH' is necessary.
- This IC always detects whether SDA and SCL are in start condition (start bit) or not, therefore, unless this condition is satisfied, any command is executed.

○ Stop condition (stop bit recognition)

- Each command can be ended by SDA rising from 'LOW' to 'HIGH' when stop condition (stop bit), namely, SCL is 'HIGH'

○ Acknowledge (ACK) signal

- This acknowledge (ACK) signal is a software rule to show whether data transfer has been made normally or not. In master and slave, the device (μ -COM at slave address input of write command, read command, and this IC at data output of read command) at the transmitter (sending) side releases the bus after output of 8bit data.
- The device (this IC at slave address input of write command, read command, and μ -COM at data output of read command) at the receiver (receiving) side sets SDA 'LOW' during 9 clock cycles, and outputs acknowledge signal (ACK signal) showing that it has received the 8bit data.
- This IC, after recognizing start condition and slave address (8bit), outputs acknowledge signal (ACK signal) 'LOW'.
- Each write action outputs acknowledge signal (ACK signal) 'LOW', at receiving 8bit data (word address and write data).
- Each read action outputs 8bit data (read data), and detects acknowledge signal (ACK signal) 'LOW'.
- When acknowledge signal (ACK signal) is detected, and stop condition is not sent from the master (μ -COM) side, this IC continues data output. When acknowledge signal (ACK signal) is not detected, this IC stops data transfer, and recognizes stop condition (stop bit), and ends read action. And this IC gets in standby status.

○ Device addressing

- Output slave address after start condition from master.
- The significant 4 bits of slave address are used for recognizing a device type. The device code of this IC is fixed to '1010'.
- Next slave addresses (A2 A1 A0 --- device address) are for selecting devices, and plural ones can be used on a same bus according to the number of device addresses.
- The most insignificant bit (R/W --- READ/WRITE) of slave address is used for designating write or read action, and is as shown below.

Setting $\overline{R/W}$ to 0 --- write (setting 0 to word address setting of random read)

Setting $\overline{R/W}$ to 1 --- read

Type	Slave address	Maximum number of connected buses
BR24S08-W	1 0 1 0 A2 P1 P0 $\overline{R/W}$	2
BR24S16-W	1 0 1 0 P2 P1 P0 $\overline{R/W}$	1
BR24S32-W, BR24S64-W BR24S128-W, BR24S256-W	1 0 1 0 A2 A1 A0 $\overline{R/W}$	8



P0~P2 are page select bits.

Note) Up to 2 units of BR24S08-W, up to 1 units of BR24S16-W, and up to 8 units of BR24S32/64/128/256-W can be connected.

Device address is set by 'H' and 'L' of each pin of A0, A1, and A2.

● Write Command

○ Write cycle

- Arbitrary data is written to EEPROM. When to write only 1 byte, byte write normally used, and when to write continuous data of 2 bytes or more, simultaneous write is possible by page write cycle. The maximum number of write bytes is specified per device of each capacity.
- Up to 64 arbitrary bytes can be written. (In the case of BR24S128/256-W)



Fig.33 Byte write cycle (BR24S08/16-W)



*1 As for WA12, BR24S32-W becomes Don't care.
As for WA13, BR24S32/64-W becomes Don't care.
As for WA14, BR24S32/64/128-W becomes Don't care.

Fig.34 Byte write cycle (BR24S32/64/128/256-W)



Fig.35 Page write cycle (BR24S08/16-W)



*1 As for WA12, BR24S32-W becomes Don't care.
As for WA13, BR24S32/64-W becomes Don't care.
As for WA14, BR24S32/64/128-W becomes Don't care.

*2 As for BR24S128/256-W becomes (n+63).

Fig.36 Page write cycle (BR24S32/64/128/256-W)

- Data is written to the address designated by word address (n-th address).
- By issuing stop bit after 8bit data input, write to memory cell inside starts.
- When internal write is started, command is not accepted for tWR (5ms at maximum).
- By page write cycle, the following can be written in bulk:
 - Up to 16 bytes (BR24S08-W, BR24S16-W)
 - Up to 32 bytes (BR24S32-W, BR24S64-W)
 - Up to 64 bytes (BR24S128-W, BR24S256-W)

And when data of the maximum bytes or higher is sent, data from the first byte is overwritten. (Refer to "Internal address increment of "Notes on page write cycle" in P24/32.)

- As for page write command of BR24S08-W and, BR24S16-W, after page select bit(PS) of slave address is designated arbitrarily, by continuing data input of 2 bytes or more, the address of insignificant 4 bits is incremented internally, and data up to 16 bytes can be written.
- As for page write cycle of BR24S32-W and BR24S64-W, after the significant 7 bits (in the case of BR24S32-W) of word address, or the significant 8 bits (in the case of BR24S64-W) of word address are designated arbitrarily, by continuing data input of 2 bytes or more, the address of insignificant 5 bits is incremented internally, and data up to 32 bytes can be written.
- As for page write cycle of BR24S128-W and BR24S256-W, after the significant 9 bit (in the case of BR24S128-W) of word address, or the significant 10bit (in the case of BR24S256-W) of word address are designated arbitrarily, by continuing data input of 64 bytes or more.

Note)

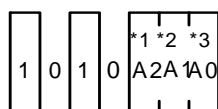

- *1 In BR24S16-W, A2 becomes P2
- *2 In BR24S08/16-W, A1 becomes P1
- *3 In BR24S08/16-W, A0 becomes P0

Fig.37 Difference of slave address each type

○Notes on write cycle continuous input



Fig.38 Page write cycle(BR24S08/16-W)



Fig.39 Page write cycle(BR24S32/64/128/256-W)

○Notes on page write cycle

List of numbers of page write

Number of pages	16Byte	32Byte	64Byte
Product number	BR24S08-W BR24S16-W	BR24S32-W BR24S64-W	BR24S128-W BR24S256-W

The above numbers are maximum bytes for respective types. Any bytes below these can be written.
In the case of BR24S256-W, 1 page = 64bytes, but the page write cycle write time is 5ms at maximum for 64byte bulk write.
It does not stand 5ms at maximum × 64byte = 320ms(Max.).

○Internal address increment

Page write mode (in the case of BR24S16-W)



For example, when it is started from address 0Eh, therefore, increment is made as below, 0Eh→0Fh→00h→01h..., which please note.

* 0Eh...16 in hexadecimal, therefore, 00001110 becomes a binary number.

○Write protect (WP) terminal

• Write protect (WP) function

When WP terminal is set Vcc (H level), data rewrite of all address is prohibited. When it is set GND (L level), data rewrite of all address is enabled. Be sure to connect this terminal to Vcc or GND, or control it to H level or L level. Do not use it open. At extremely low voltage at power ON/OFF, by setting the WP terminal 'H', mistake write can be prevented. During tWR, set the WP terminal always to 'L'. If it is set 'H', write is forcibly terminated.

●Read Command

○Read cycle

Data of EEPROM is read. In read cycle, there are random read cycle and current read cycle. Random read cycle is a command to read data by designating address, and is used generally. Current read cycle is a command to read data of internal address register without designating address, and is used when to verify just after write cycle. In both the read cycles, sequential read cycle is available, and the next address data can be read in succession.



Fig.40 Random read cycle (BR24S08/16-W)

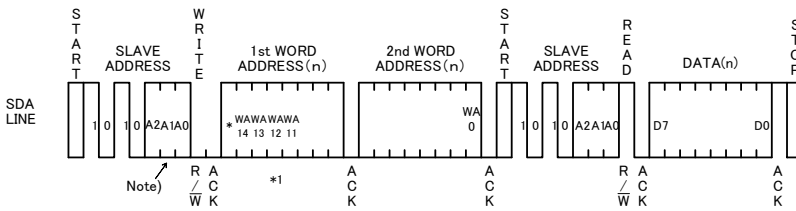

Fig.41 Random read cycle (BR24S32/64/128/256-W)

It is necessary to input 'H' to the last ACK.

*1 As for WA12, BR24S32-W become Don't care.
As for WA13, BR24S32/64-W become Don't care.
As for WA14, BR24S32/64/128-W become Don't care.



Fig.42 Current read cycle

It is necessary to input 'H' to the last ACK.

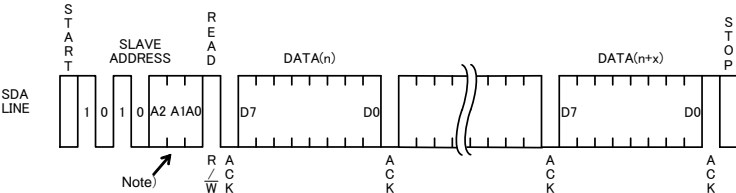
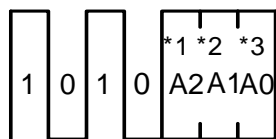

Fig.43 Sequential read cycle (in the case of current read cycle)

- In random read cycle, data of designated word address can be read.
- When the command just before current read cycle is random read cycle, current read cycle (each including sequential read cycle), data of incremented last read address (n)-th address, i.e., data of the (n+1)-th address is output.
- When ACK signal 'LOW' after D0 is detected, and stop condition is not sent from master (μ -COM) side, the next address data can be read in succession.
- Read cycle is ended by stop condition where 'H' is input to ACK signal after D0 and SDA signal is started at SCL signal 'H'.
- When 'H' is not input to ACK signal after D0, sequential read gets in, and the next data is output. Therefore, read command cycle cannot be ended. When to end read command cycle, be sure input stop condition to input 'H' to ACK signal after D0, and to start SDA at SCL signal 'H'.
- Sequential read is ended by stop condition where 'H' is input to ACK signal after arbitrary D0 and SDA is started at SCL signal 'H'.

Note)



- *1 BR24S16-W A2 becomes P2.
- *2 BR24S08/16-W A1 becomes P1.
- *3 BR24S08/16-W A0 becomes P0.

Fig.44 Difference of slave address of each type

● Software reset

Software reset is executed when to avoid malfunction after power on, and to reset during command input. Software reset has several kinds, and 3 kinds of them are shown in the figure below. (Refer to Fig.45(a), Fig.45(b), Fig.45(c).) In dummy clock input area, release the SDA bus ('H' by pull up). In dummy clock area, ACK output and read data '0' (both 'L' level) may be output from EEPROM, therefore, if 'H' is input forcibly, output may conflict and over current may flow, leading to instantaneous power failure of system power source or influence upon devices.

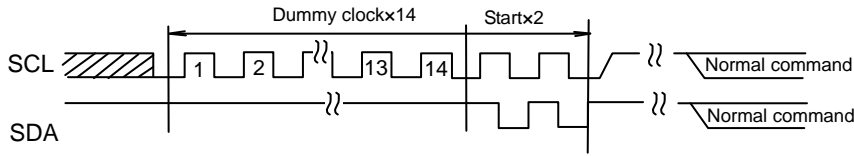

Fig.45-(a) The case of 14 Dummy clock + START + START+ command input

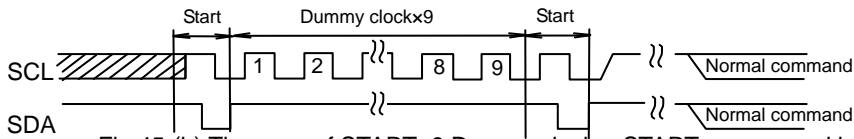

Fig.45-(b) The case of START+9 Dummy clock + START + command input



* Start command from START input.

Fig.45-(c) START x 9 + command input

● Acknowledge polling

During internal write, all input commands are ignored, therefore ACK is not sent back. During internal automatic write execution after write cycle input, next command (slave address) is sent, and if the first ACK signal sends back 'L', then it means end of write action, while if it sends back 'H', it means now in writing. By use of acknowledge polling, next command can be executed without waiting for $t_{WR} = 5ms$.

When to write continuously, $R/\bar{W} = 0$, when to carry out current read cycle after write, slave address $R/\bar{W} = 1$ is sent, and if ACK signal sends back 'L', then execute word address input and data so forth.

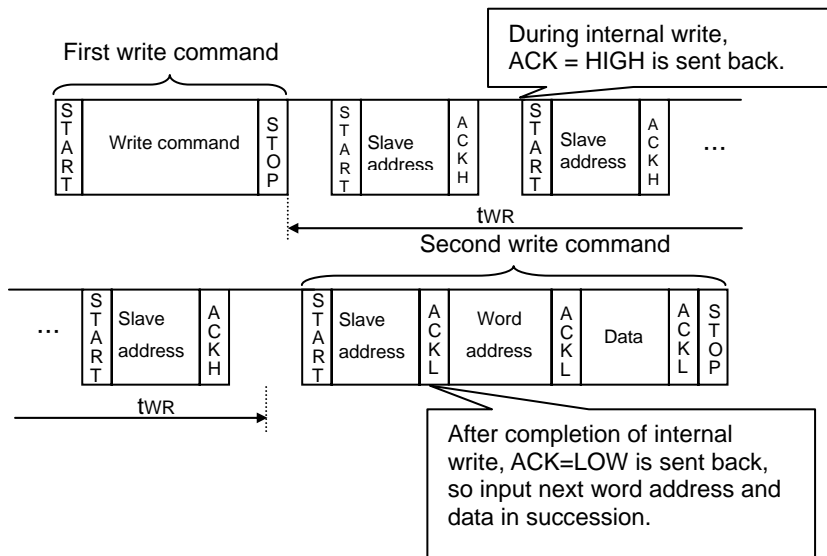

Fig.46 Case to continuously write by acknowledge polling

● WP valid timing (write cancel)

WP is usually fixed to 'H' or 'L', but when WP is used to cancel write cycle and so forth, pay attention to the following WP valid timing. During write cycle execution, in cancel valid area, by setting WP='H', write cycle can be cancelled. In both byte write cycle and page write cycle, the area from the first start condition of command to the rise of clock to taken in D0 of data (in page write cycle, the first byte data) is cancel invalid area.

WP input in this area becomes Don't care. Set the setup time to rise of D0 taken 100ns or more. The area from the rise of SCL to take in D0 to the end of internal automatic write (t_{WR}) is cancel valid area. And, when it is set WP='H' during t_{WR} , write is ended forcibly, data of address under access is not guaranteed, therefore, write it once again. (Refer to Fig.47.) After execution of forced end by WP standby status gets in, so there is no need to wait for t_{WR} (5ms at maximum).



Fig.47 WP valid timing

● Command cancel by start condition and stop condition

During command input, by continuously inputting start condition and stop condition, command can be cancelled. (Refer to Fig. 48.)

However, in ACK output area and during data read, SDA bus may output 'L', and in this case, start condition and stop condition cannot be input, so reset is not available. Therefore, execute software reset. And when command is cancelled by start, stop condition, during random read cycle, sequential read cycle, or current read cycle, internal setting address is not determined, therefore, it is not possible to carry out current read cycle in succession. When to carry out read cycle in succession, carry out random read cycle.



Fig.48 Case of cancel by start, stop condition during slave address input

● I/O peripheral circuit

○ Pull up resistance of SDA terminal

SDA is NMOS open drain, so requires pull up resistance. As for this resistance value (R_{PU}), select an appropriate value to this resistance value from microcontroller V_{IL} , I_L , and V_{OL} - I_{OL} characteristics of this IC. If R_{PU} is large, action frequency is limited. The smaller the R_{PU} , the larger the consumption current at action.

○ Maximum value of R_{PU}

The maximum value of R_{PU} is determined by the following factors.

(1) SDA rise time to be determined by the capacitance (CBUS) of bus line of R_{PU} and SDA should be t_R or below.

And AC timing should be satisfied even when SDA rise time is late.

(2) The bus electric potential (A) to be determined by input leak total (I_L) of device connected to bus output of 'H' to SDA bus and R_{PU} should sufficiently secure the input 'H' level (V_{IH}) of microcontroller and EEPROM including recommended noise margin $0.2V_{CC}$.

$$V_{CC} - I_L R_{PU} - 0.2V_{CC} \geq V_{IH}$$

$$\therefore R_{PU} \leq \frac{0.8V_{CC} - V_{IH}}{I_L}$$

Ex.) When $V_{CC} = 3V$, $I_L = 10\mu A$, $V_{IH} = 0.7V_{CC}$
from (2)

$$R_{PU} \leq \frac{0.8 \times 3 - 0.7 \times 3}{10 \times 10^{-6}}$$

$$\leq 300 \text{ [k}\Omega\text{]}$$

○ Minimum value of R_{PU}

The minimum value of R_{PU} is determined by the following factors.

(1) When IC outputs LOW, it should be satisfied that $V_{OLMAX} = 0.4V$ and $I_{OLMAX} = 3mA$.

$$\frac{V_{CC} - V_{OL}}{R_{PU}} \leq I_{OL}$$

$$\therefore R_{PU} \geq \frac{V_{CC} - V_{OL}}{I_{OL}}$$

(2) $V_{OLMAX} = 0.4V$ should secure the input 'L' level (V_{IL}) of microcontroller and EEPROM including recommended noise margin $0.1V_{CC}$.

$$V_{OLMAX} \leq V_{IL} - 0.1V_{CC}$$

Ex.) When $V_{CC} = 3V$, $V_{OL} = 0.4V$, $I_{OL} = 3mA$, microcontroller, EEPROM $V_{IL} = 0.3V_{CC}$
from (1),

$$R_{PU} \geq \frac{3 - 0.4}{3 \times 10^{-3}}$$

$$\geq 867 \text{ [}\Omega\text{]}$$

And

$$V_{OL} = 0.4 \text{ [V]}$$

$$V_{IL} = 0.3 \times 3$$

$$= 0.9 \text{ [V]}$$

Therefore, the condition (2) is satisfied.

○ Pull up resistance of SCL terminal

When SCL control is made at CMOS output port, there is no need, but in the case there is timing where SCL becomes 'Hi-Z', add a pull up resistance. As for the pull up resistance, one of several $k\Omega$ ~ several ten $k\Omega$ is recommended in consideration of drive performance of output port of microcontroller.

● A0, A1, A2, WP process

○ Process of device address terminals (A0, A1, A2)

Check whether the set device address coincides with device address input sent from the master side or not, and select one among plural devices connected to a same bus. Connect this terminal to pull up or pull down, or V_{CC} or GND. And, pins (Don't use PIN) not used as device address may be set to any of 'H', 'L', and 'Hi-Z'.

Types with Don't use PIN	BR24S08F/FJ/FV/FVT/FVM/FVJ/NUX-W	A0, A1
	BR24S16F/FJ/FV/FVT/FVM/FVJ/NUX-W	A0, A1, A2

○ Process of WP terminal

WP terminal is the terminal that prohibits and permits write in hardware manner. In 'H' status, only READ is available and WRITE of all address is prohibited. In the case of 'L', both are available. In the case of use it as an ROM, it is recommended to connect it to pull up or V_{CC} . In the case to use both READ and WRITE, control WP terminal or connect it to pull down or GND.



Fig.49 I/O circuit diagram

●Cautions on microcontroller connection

○Rs

In I²C BUS, it is recommended that SDA port is of open drain input/output. However, when to use CMOS input / output of tri state to SDA port, insert a series resistance Rs between the pull up resistance Rpu and the SDA terminal of EEPROM. This is controls over current that occurs when PMOS of the microcontroller and NMOS of EEPROM are turned ON simultaneously. Rs also plays the role of protection of SDA terminal against surge. Therefore, even when SDA port is open drain input/output, Rs can be used.



Fig.50 I/O circuit diagram



Fig.51 Input/output collision timing

○Maximum value of Rs

The maximum value of Rs is determined by following relations.

- (1) SDA rise time to be determined by the capacity (CBUS) of bus line of Rpu and SDA should be tR or below. And AC timing should be satisfied even when SDA rise time is late.
- (2) The bus electric potential (A) to be determined by Rpu and Rs the moment when EEPROM outputs 'L' to SDA bus should sufficiently secure the input 'L' level (VIL) of microcontroller including recommended noise margin 0.1Vcc.



Fig.52 I/O circuit diagram

$$\frac{(V_{CC}-V_{OL}) \times R_S}{R_{PU}+R_S} + V_{OL} + 0.1V_{CC} \leq V_{IL}$$

$$\therefore R_S \leq \frac{V_{IL}-V_{OL}-0.1V_{CC}}{1.1V_{CC}-V_{IL}} \times R_{PU}$$

Example) When VCC=3V, VIL=0.3VCC, VOL=0.4V, RPU=20kΩ
 from(2), $R_S \leq \frac{0.3 \times 3 - 0.4 - 0.1 \times 3}{1.1 \times 3 - 0.3 \times 3} \times 20 \times 10^3$
 ≤ 1.67 [kΩ]

○Minimum value of Rs

The minimum value of Rs is determined by over current at bus collision. When over current flows, noises in power source line, and instantaneous power failure of power source may occur. When allowable over current is defined as I, the following relation must be satisfied. Determine the allowable current in consideration of impedance of power source line in set and so forth. Set the over current to EEPROM 10mA or below.



Fig.53 I/O circuit diagram

$$\frac{V_{CC}}{R_S} \leq I$$

$$\therefore R_S \geq \frac{V_{CC}}{I}$$

Example) When VCC=3V, I=10mA

$$R_S \geq \frac{3}{10 \times 10^{-3}}$$

● I²C BUS input / output circuit

○ Input (A0, A1, A2, SCL, WP)



Fig.54 Input pin circuit diagram

○ Input/Output (SDA)



Fig.55 Input /output pin circuit diagram

● Notes on power ON

At power on, in IC internal circuit and set, Vcc rises through unstable low voltage area, and IC inside is not completely reset, and malfunction may occur. To prevent this, functions of POR circuit and LVCC circuit are equipped. To assure the action, observe the following condition at power on.

1. Set SDA = 'H' and SCL = 'L' or 'H'
2. Start power source so as to satisfy the recommended conditions of tR, tOFF, and Vbot for operating POR circuit.



Fig.56 Rise waveform diagram

Recommended conditions of tR, tOFF, Vbot

tR	tOFF	Vbot
10ms or below	10ms or longer	0.3V or below
100ms or below	10ms or longer	0.2V or below

3. Set SDA and SCL so as not to become 'Hi-Z'.

When the above conditions 1 and 2 cannot be observed, take the following countermeasures.

- a) In the case when the above conditions 1 cannot be observed. When SDA becomes 'L' at power on.
 - Control SCL and SDA as shown below, to make SCL and SDA, 'H' and 'H'.



Fig.57 When SCL='H' and SDA='L'



Fig.58 When SCL='H' and SDA='L'

- b) In the case when the above condition 2 cannot be observed.
 - After power source becomes stable, execute software reset(P26).
- c) In the case when the above conditions 1 and 2 cannot be observed.
 - Carry out a), and then carry out b).

● Low voltage malfunction prevention function

LVCC circuit prevents data rewrite action at low power, and prevents wrong write.
At LVCC voltage (Typ. =1.2V) or below, it prevent data rewrite.

● Vcc noise countermeasures**○ Bypass capacitor**

When noise or surge gets in the power source line, malfunction may occur, therefore, for removing these, it is recommended to attach a by pass capacitor (0.1μF) between IC Vcc and GND. At that moment, attach it as close to IC as possible.

And, it is also recommended to attach a bypass capacitor between board Vcc and GND.

● Notes for use

- (1) Described numeric values and data are design representative values, and the values are not guaranteed.
- (2) We believe that application circuit examples are recommendable, however, in actual use, confirm characteristics further sufficiently. In the case of use by changing the fixed number of external parts, make your decision with sufficient margin in consideration of static characteristics and transition characteristics and fluctuations of external parts and our LSI.
- (3) Absolute maximum ratings
If the absolute maximum ratings such as impressed voltage and action temperature range and so forth are exceeded, LSI may be destructed. Do not impress voltage and temperature exceeding the absolute maximum ratings. In the case of fear exceeding the absolute maximum ratings, take physical safety countermeasures such as fuses, and see to it that conditions exceeding the absolute maximum ratings should not be impressed to LSI.
- (4) GND electric potential
Set the voltage of GND terminal lowest at any action condition. Make sure that each terminal voltage is lower than that of GND terminal.
- (5) Terminal design
In consideration of permissible loss in actual use condition, carry out heat design with sufficient margin.
- (6) Terminal to terminal shortcircuit and wrong packaging
When to package LSI onto a board, pay sufficient attention to LSI direction and displacement. Wrong packaging may destruct LSI. And in the case of shortcircuit between LSI terminals and terminals and power source, terminal and GND owing to foreign matter, LSI may be destructed.
- (7) Use in a strong electromagnetic field may cause malfunction, therefore, evaluate design sufficiently.

●Ordering part number

B	R	2	4	S	2	5	6	F	-	W	E	2
Part No.		BUS type 24 : I ² C		Operating temperature/ Power source voltage L: -40°C~+85°C/ 1.8V ~ 5.5V S: -40°C~+85°C/ 1.7V ~ 5.5V	Capacity 01=1K 16=16K 02=2K 32=32K 04=4K 64=64K 08=8K 128=128K 256=256K			Package F : SOP8 FJ : SOP-J8 FV : SSOP-B8 FVM : MSOP8 FVT : TSSOP-B8 FVJ : TSSOP-B8J NUX : VSON008X2030		Double cell	Packaging and forming specification E2: Embossed tape and reel TR: Embossed tape and reel	

●Package specifications

SOP8



<Tape and Reel information>

Tape	Embossed carrier tape
Quantity	2500pcs
Direction of feed	E2 (The direction is the 1pin of product is at the upper left when you hold reel on the left hand and you pull out the tape on the right hand)



SOP-J8



<Tape and Reel information>

Tape	Embossed carrier tape
Quantity	2500pcs
Direction of feed	E2 (The direction is the 1pin of product is at the upper left when you hold reel on the left hand and you pull out the tape on the right hand)



SSOP-B8



<Tape and Reel information>

Tape	Embossed carrier tape
Quantity	2500pcs
Direction of feed	E2 (The direction is the 1pin of product is at the upper left when you hold reel on the left hand and you pull out the tape on the right hand)



TSSOP-B8



<Tape and Reel information>

Tape	Embossed carrier tape
Quantity	3000pcs
Direction of feed	E2 (The direction is the 1pin of product is at the upper left when you hold reel on the left hand and you pull out the tape on the right hand)

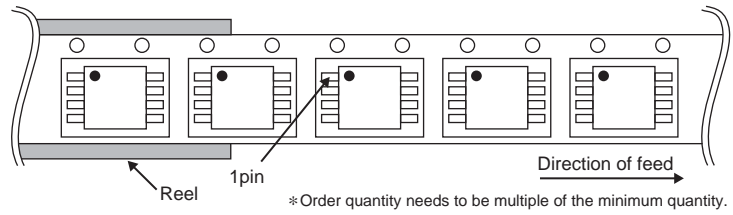

TSSOP-B8J



<Tape and Reel information>

Tape	Embossed carrier tape
Quantity	2500pcs
Direction of feed	E2 (The direction is the 1pin of product is at the upper left when you hold reel on the left hand and you pull out the tape on the right hand)

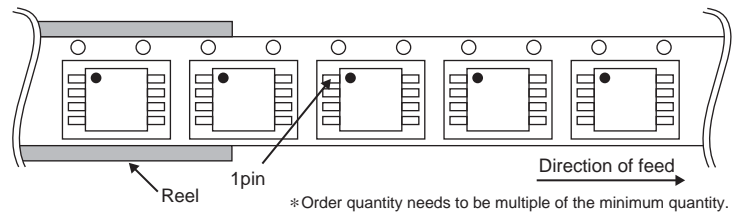

MSOP8



<Tape and Reel information>

Tape	Embossed carrier tape
Quantity	3000pcs
Direction of feed	TR (The direction is the 1pin of product is at the upper right when you hold reel on the left hand and you pull out the tape on the right hand)

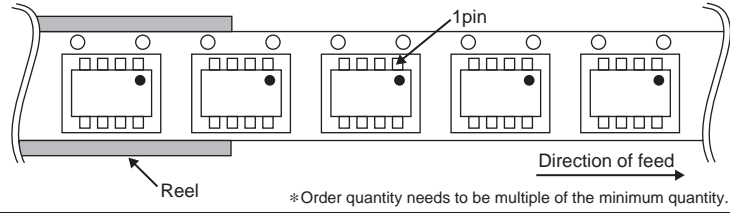

VSON008X2030



<Tape and Reel information>

Tape	Embossed carrier tape
Quantity	4000pcs
Direction of feed	TR (The direction is the 1pin of product is at the upper right when you hold reel on the left hand and you pull out the tape on the right hand)

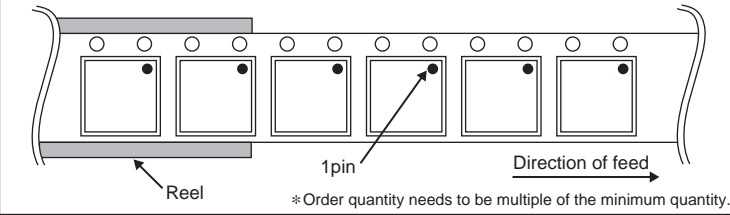

Notes

No copying or reproduction of this document, in part or in whole, is permitted without the consent of ROHM Co.,Ltd.

The content specified herein is subject to change for improvement without notice.

The content specified herein is for the purpose of introducing ROHM's products (hereinafter "Products"). If you wish to use any such Product, please be sure to refer to the specifications, which can be obtained from ROHM upon request.

Examples of application circuits, circuit constants and any other information contained herein illustrate the standard usage and operations of the Products. The peripheral conditions must be taken into account when designing circuits for mass production.

Great care was taken in ensuring the accuracy of the information specified in this document. However, should you incur any damage arising from any inaccuracy or misprint of such information, ROHM shall bear no responsibility for such damage.

The technical information specified herein is intended only to show the typical functions of and examples of application circuits for the Products. ROHM does not grant you, explicitly or implicitly, any license to use or exercise intellectual property or other rights held by ROHM and other parties. ROHM shall bear no responsibility whatsoever for any dispute arising from the use of such technical information.

The Products specified in this document are intended to be used with general-use electronic equipment or devices (such as audio visual equipment, office-automation equipment, communication devices, electronic appliances and amusement devices).

The Products specified in this document are not designed to be radiation tolerant.

While ROHM always makes efforts to enhance the quality and reliability of its Products, a Product may fail or malfunction for a variety of reasons.

Please be sure to implement in your equipment using the Products safety measures to guard against the possibility of physical injury, fire or any other damage caused in the event of the failure of any Product, such as derating, redundancy, fire control and fail-safe designs. ROHM shall bear no responsibility whatsoever for your use of any Product outside of the prescribed scope or not in accordance with the instruction manual.

The Products are not designed or manufactured to be used with any equipment, device or system which requires an extremely high level of reliability the failure or malfunction of which may result in a direct threat to human life or create a risk of human injury (such as a medical instrument, transportation equipment, aerospace machinery, nuclear-reactor controller, fuel-controller or other safety device). ROHM shall bear no responsibility in any way for use of any of the Products for the above special purposes. If a Product is intended to be used for any such special purpose, please contact a ROHM sales representative before purchasing.

If you intend to export or ship overseas any Product or technology specified herein that may be controlled under the Foreign Exchange and the Foreign Trade Law, you will be required to obtain a license or permit under the Law.



Thank you for your accessing to ROHM product informations.
More detail product informations and catalogs are available, please contact us.

ROHM Customer Support System

<http://www.rohm.com/contact/>

Компания «Океан Электроники» предлагает заключение долгосрочных отношений при поставках импортных электронных компонентов на взаимовыгодных условиях!

Наши преимущества:

- Поставка оригинальных импортных электронных компонентов напрямую с производств Америки, Европы и Азии, а так же с крупнейших складов мира;
- Широкая линейка поставок активных и пассивных импортных электронных компонентов (более 30 млн. наименований);
- Поставка сложных, дефицитных, либо снятых с производства позиций;
- Оперативные сроки поставки под заказ (от 5 рабочих дней);
- Экспресс доставка в любую точку России;
- Помощь Конструкторского Отдела и консультации квалифицированных инженеров;
- Техническая поддержка проекта, помощь в подборе аналогов, поставка прототипов;
- Поставка электронных компонентов под контролем ВП;
- Система менеджмента качества сертифицирована по Международному стандарту ISO 9001;
- При необходимости вся продукция военного и аэрокосмического назначения проходит испытания и сертификацию в лаборатории (по согласованию с заказчиком);
- Поставка специализированных компонентов военного и аэрокосмического уровня качества (Xilinx, Altera, Analog Devices, Intersil, Interpoint, Microsemi, Actel, Aeroflex, Peregrine, VPT, Syfer, Eurofarad, Texas Instruments, MS Kennedy, Miteq, Cobham, E2V, MA-COM, Hittite, Mini-Circuits, General Dynamics и др.);

Компания «Океан Электроники» является официальным дистрибьютором и эксклюзивным представителем в России одного из крупнейших производителей разъемов военного и аэрокосмического назначения «JONHON», а так же официальным дистрибьютором и эксклюзивным представителем в России производителя высокотехнологичных и надежных решений для передачи СВЧ сигналов «FORSTAR».



JONHON

«JONHON» (основан в 1970 г.)

Разъемы специального, военного и аэрокосмического назначения:

(Применяются в военной, авиационной, аэрокосмической, морской, железнодорожной, горно- и нефтедобывающей отраслях промышленности)

«FORSTAR» (основан в 1998 г.)

ВЧ соединители, коаксиальные кабели,
кабельные сборки и микроволновые компоненты:

(Применяются в телекоммуникациях гражданского и специального назначения, в средствах связи, РЛС, а так же военной, авиационной и аэрокосмической отраслях промышленности).



Телефон: 8 (812) 309-75-97 (многоканальный)

Факс: 8 (812) 320-03-32

Электронная почта: ocean@oceanchips.ru

Web: <http://oceanchips.ru/>

Адрес: 198099, г. Санкт-Петербург, ул. Калинина, д. 2, корп. 4, лит. А