

Long Sensing-distance Capacitive Separate Amplifier Proximity Sensor E2J

CSM_E2J_DS_E_3_1

Compact and Ideal for Robot Hands. Especially Effective in Detecting LCDs, Wafers, and PDPs.*

- Flat head is only 5.5-mm thick.
- Robotics cable ensures improved flexibility.
- Operation indicator on the Sensor Head.
- Easy-to-use connector.

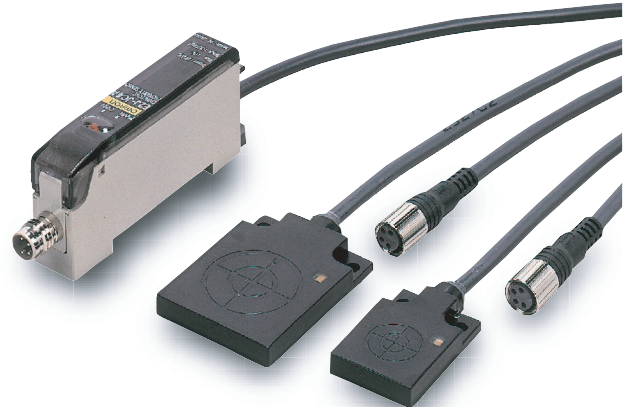



* Plasma Display Panel (for wall-mounted TVs)

 Be sure to read *Safety Precautions* on page 5.

Ordering Information

Sensors

[Refer to *Dimensions* on page 6.]

Appearance	Sensing distance (variable)	Model	Amplifier Units	Model
	 10 mm (4 to 10 mm)	E2J-W10MA 1M	DC 3-wire NPN Open-collector output	E2J-JC4A 2M
	 20 mm (8 to 20 mm)	E2J-W20MA 1M		

Accessories (Order Separately)

Dust Covers [Refer to *Dimensions* on page 6.]

Appearance	Application	Application	Model
	Dust protection *	E2J-JC4A Amplifier Unit	XS3Z-13
		E2J-W□MA Sensor	XS3Z-15

* These dust covers are for protection against dust. They do not satisfy IP67. When attaching the Dust Cover, be sure to fully insert the connector into the Dust Cover.

Sensor I/O Connectors with Cables [Refer to *XS3*.]

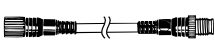
Appearance	Application	Cable conductors	Cable length	Model	Remarks
	For cable extension	4 conductors	1 m	XS3W-M421-401-R	M8-screw-mounting cables Robotics cables (vibration resistant) Straight/Straight Model
			2 m	XS3W-M421-402-R	

Note: Refer to *Introduction to Sensor I/O Connectors* for details.

Ratings and Specifications

Sensors

Item	Model	
	E2J-W10MA	E2J-W20MA
Sensing distance	10 mm	20 mm
Sensing area	4 to 10 mm	8 to 20 mm
Differential travel	15% max. of sensing distance	
Detectable object	Conductors and dielectrics	
Standard sensing object	Grounded metal plate: 50 × 50 × 1 mm	
Response frequency	70 Hz min.	
Indicators	Detection indicator (red)	
Ambient temperature range	Operating/Storage: -10 to 55°C (with no icing or condensation)	
Ambient humidity range	Operating/Storage: 35% to 95% (with no condensation)	
Vibration resistance	Destruction: 10 to 500 Hz, 2-mm double amplitude or 150 m/s ² for 2 hours each in X, Y, and Z directions	
Shock resistance	Destruction: 500 m/s ² 3 times each in X, Y, and Z directions	
Degree of protection	IP66 (IEC)	
Connection method	Pre-wired Connector Models (Robotics cable, Standard cable length: 1m)	
Weight (packed state)	Approx. 30 g	Approx. 40 g
Materials	Case Heat-resistant ABS	

Amplifier Units

Item	Model
	E2J-JC4A
Power supply voltage	24 VDC ±20%, ripple (p-p): 10% max.
Current consumption	30 mA max.
Control output	Load current NPN open-collector output, 100 mA max. (30 VDC max.)
	Residual voltage 1 V max.
Indicators	Operation indicator (orange) Power indicator (green)
Number of turns of sensitivity adjustment	8 turns with an indicator
Protection circuits	Load short-circuit protection, Surge suppressor, Reverse polarity protection
Ambient temperature range	Operating/Storage: -10 to 55°C (with no icing or condensation)
Ambient humidity range	Operating/Storage: 35% to 85% (with no condensation)
Temperature influence (Sensor with Amplifier)	±25% max. of sensing distance at 23°C in the temperature range of 0 to 40°C
Voltage influence	±1% max. of sensing distance at the rated voltage in the ±20% rated voltage range
Insulation resistance	50 MΩ min. (at 500 VDC) between current-carrying parts and case
Dielectric strength	1,000 VAC, 50/60 Hz for 1 min between current-carrying parts and case
Vibration resistance	Destruction: 10 to 150 Hz, 1.5-mm double amplitude or 100 m/s ² for 2 hours each in X, Y, and Z directions
Shock resistance	Destruction: 300 m/s ² 3 times each in X, Y, and Z directions
Degree of protection	IP50 (IEC)
Connection method	Pre-wired Models (Standard cable length: 2 m)
Weight (packed state)	Approx. 60 g
Materials	Case ABS
Accessories	Mounting Bracket, Instruction manual

Engineering Data (Typical)

Sensing Area

E2J-W10MA

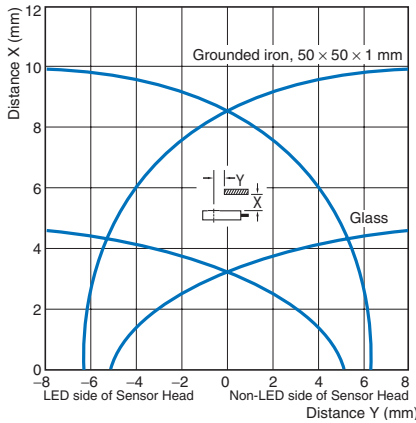

E2J-W20MA

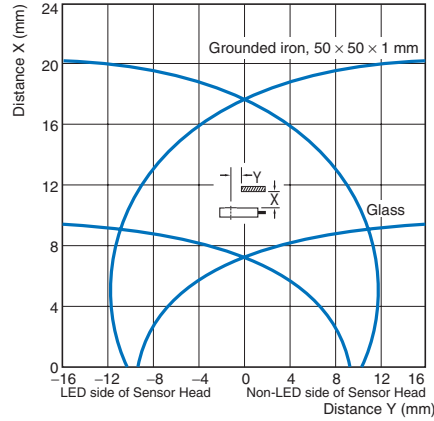

Sensing Distance Change by Sensing Object (Typical)

E2J-W10MA

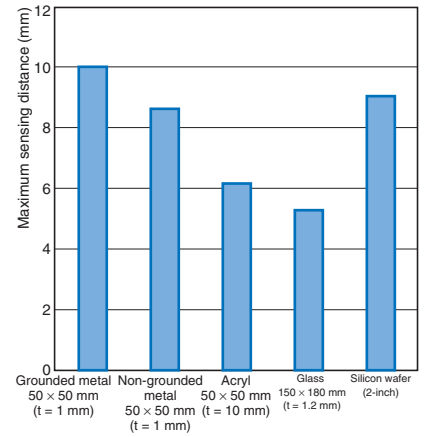

Influence of Sensing Object (Iron)

E2J-W10MA

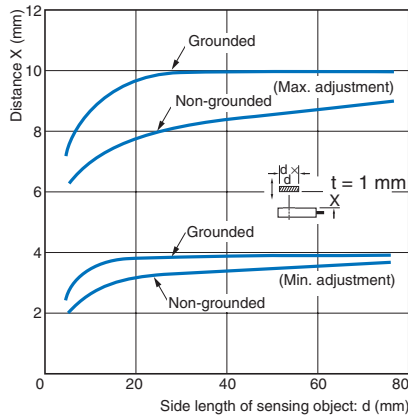

E2J-W20MA

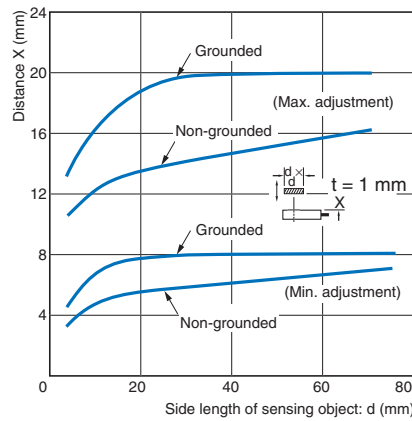

E2J-W20MA

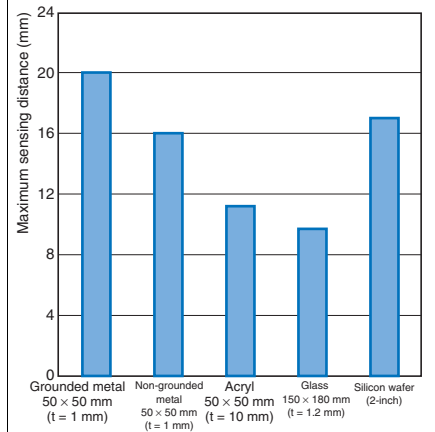

Influence of Ambient Temperature

E2J-W10MA

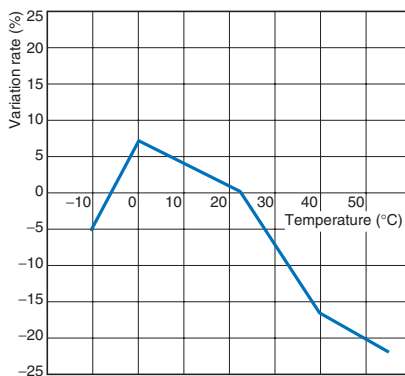

E2J-W20MA

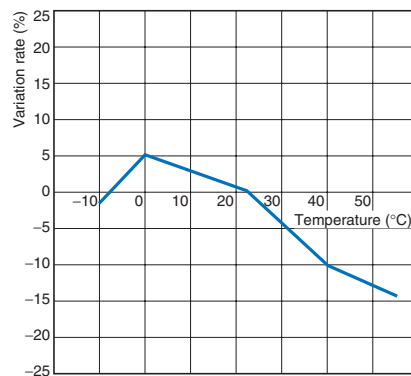

I/O Circuit Diagrams

Operation mode	Model	Timing chart	Output circuit
NO	E2J-W10MA E2J-W20MA + E2J-JC4A	Sensing object Present Not present Output transistor ON OFF Sensor detection indicator (red) ON OFF Amplifier Unit operation indicator (orange) ON OFF	
		Sensing object Present Not present Output transistor ON OFF Sensor detection indicator (red) ON OFF Amplifier Unit operation indicator (orange) ON OFF	

Amplifier Unit Nomenclature

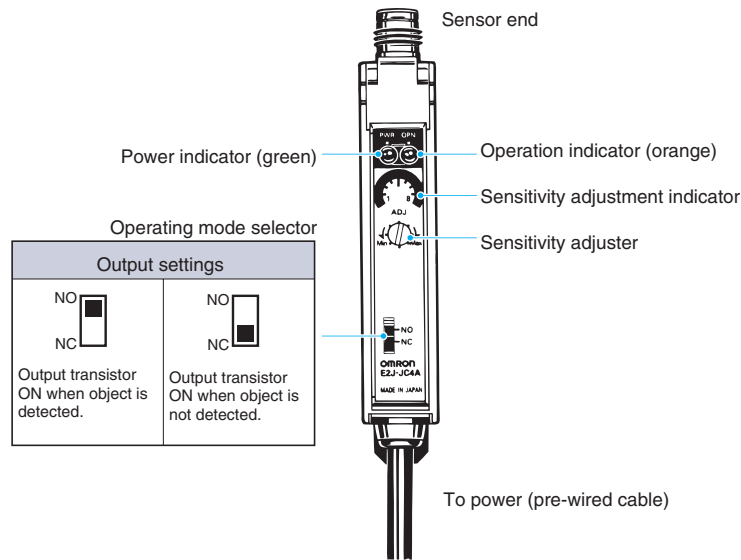

Safety Precautions

Refer to *Warranty and Limitations of Liability*.

⚠ WARNING

This product is not designed or rated for ensuring safety of persons either directly or indirectly. Do not use it for such purposes.



Precautions for Correct Use

Do not use this product under ambient conditions that exceed the ratings.

● **Design**

Influence of Surrounding Metal

When mounting the Sensor within a metal panel, ensure that the clearances given in the following table are maintained. Failure to maintain these distances may cause deterioration in the performance of the Sensor.

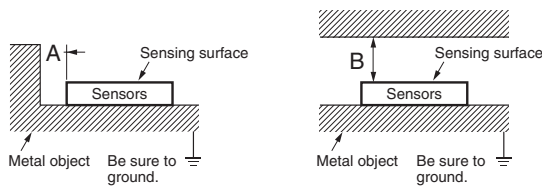

Influence of Surrounding Metal (Unit: mm)

Model	Dimension	A	B
E2J-W10MA		10	20
E2J-W20MA		20	40

Mutual Interference

When installing Sensors face-to-face or side-by-side, ensure that the minimum distances given in the following table are maintained.

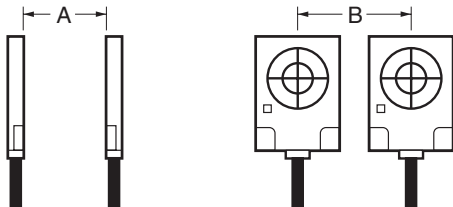

Mutual Interference (Unit: mm)

Model	Dimension	A	B
E2J-W10MA		20	30
E2J-W20MA		70	50

● **Mounting**

Handling

- Do not use the Sensor outdoors.
- Do not wire the Sensor alongside a high-tension or power line.
- Do not use portable telephones or transceivers near the Sensor. Be sure to ground the Mounting Brackets.
- Do not use the Sensor in an environment where it will be exposed to chemicals, particularly chemical solutions or oxidizing acids.

Influence of Static Electricity

Be sure to discharge static electricity before detecting objects that are greatly affected by static electricity.

Mounting the Sensor

The maximum tightening torque that should be applied is 0.54 N·m.

Cable between Sensor and Amplifier Unit

- Be sure that the bending radius of the cable is more than 5 mm.
 - Use the XS3W-M421-40□-R cable with connectors (M8-screw mounting) as the extension cable.
- The maximum cable length is 3 m (extension section: 2 m).

Dimensions

Main Units

Sensors

E2J-W10MA

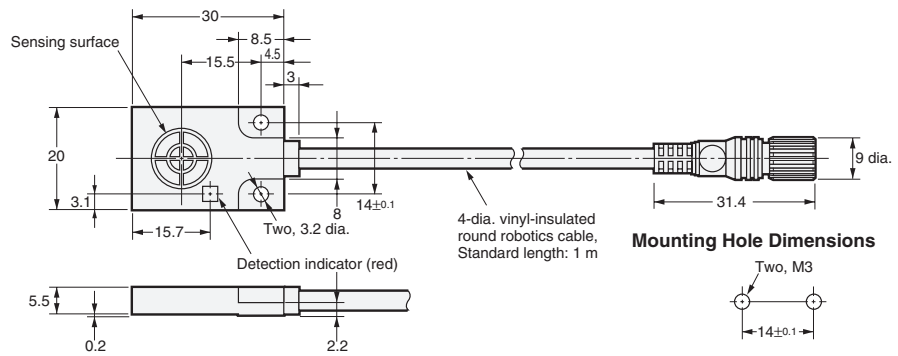
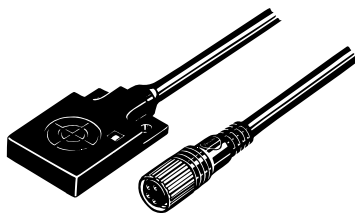

E2J-W20MA

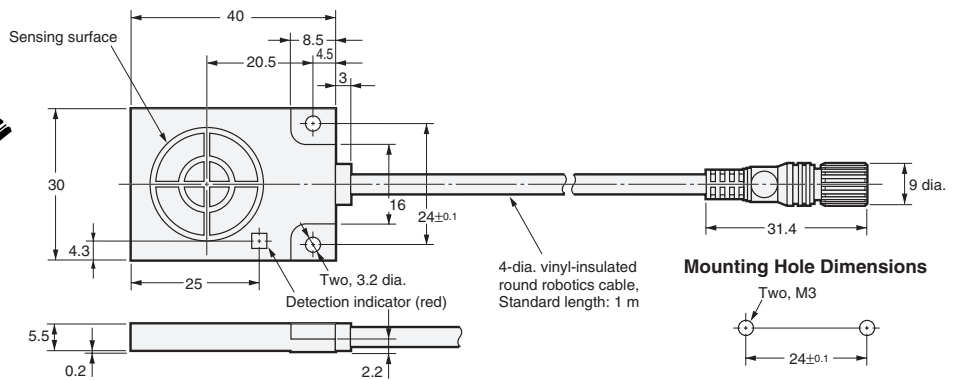
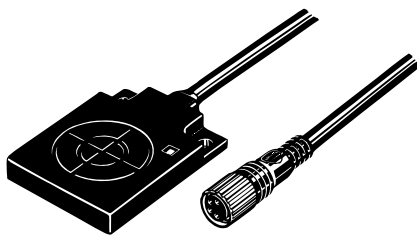

Amplifier Units

E2J-JC4A

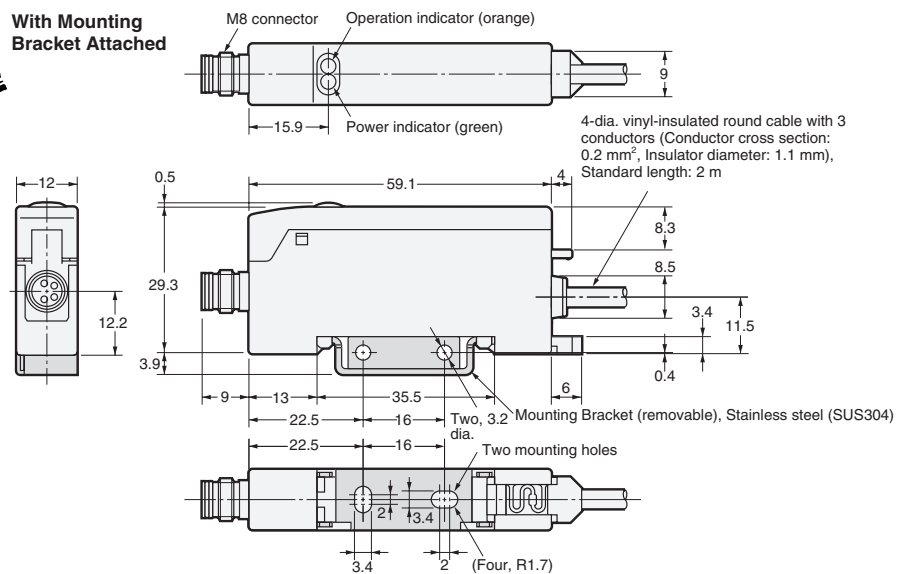
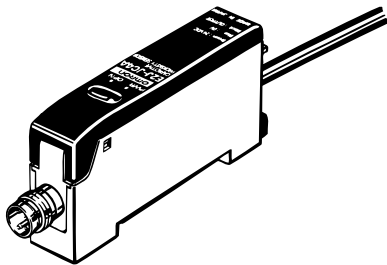

Accessories (Order Separately)

Dust Cover Material: polyvinyl chloride (red)

XS3Z-13 (for E2J-JC4A Amplifier Unit)

XS3Z-15 (for E2J-W□MA Sensor)

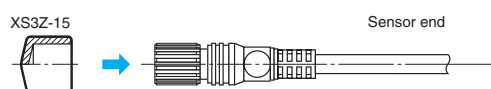
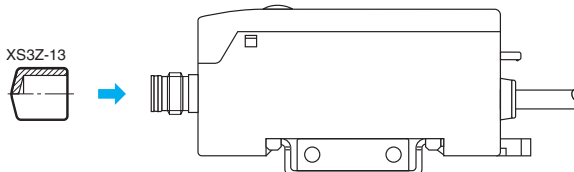

Read and Understand This Catalog

Please read and understand this catalog before purchasing the products. Please consult your OMRON representative if you have any questions or comments.

Warranty and Limitations of Liability

WARRANTY

OMRON's exclusive warranty is that the products are free from defects in materials and workmanship for a period of one year (or other period if specified) from date of sale by OMRON.

OMRON MAKES NO WARRANTY OR REPRESENTATION, EXPRESS OR IMPLIED, REGARDING NON-INFRINGEMENT, MERCHANTABILITY, OR FITNESS FOR PARTICULAR PURPOSE OF THE PRODUCTS. ANY BUYER OR USER ACKNOWLEDGES THAT THE BUYER OR USER ALONE HAS DETERMINED THAT THE PRODUCTS WILL SUITABLY MEET THE REQUIREMENTS OF THEIR INTENDED USE. OMRON DISCLAIMS ALL OTHER WARRANTIES, EXPRESS OR IMPLIED.

LIMITATIONS OF LIABILITY

OMRON SHALL NOT BE RESPONSIBLE FOR SPECIAL, INDIRECT, OR CONSEQUENTIAL DAMAGES, LOSS OF PROFITS OR COMMERCIAL LOSS IN ANY WAY CONNECTED WITH THE PRODUCTS, WHETHER SUCH CLAIM IS BASED ON CONTRACT, WARRANTY, NEGLIGENCE, OR STRICT LIABILITY.

In no event shall the responsibility of OMRON for any act exceed the individual price of the product on which liability is asserted.

IN NO EVENT SHALL OMRON BE RESPONSIBLE FOR WARRANTY, REPAIR, OR OTHER CLAIMS REGARDING THE PRODUCTS UNLESS OMRON'S ANALYSIS CONFIRMS THAT THE PRODUCTS WERE PROPERLY HANDLED, STORED, INSTALLED, AND MAINTAINED AND NOT SUBJECT TO CONTAMINATION, ABUSE, MISUSE, OR INAPPROPRIATE MODIFICATION OR REPAIR.

Application Considerations

SUITABILITY FOR USE

OMRON shall not be responsible for conformity with any standards, codes, or regulations that apply to the combination of products in the customer's application or use of the products.

At the customer's request, OMRON will provide applicable third party certification documents identifying ratings and limitations of use that apply to the products. This information by itself is not sufficient for a complete determination of the suitability of the products in combination with the end product, machine, system, or other application or use.

The following are some examples of applications for which particular attention must be given. This is not intended to be an exhaustive list of all possible uses of the products, nor is it intended to imply that the uses listed may be suitable for the products:

- Outdoor use, uses involving potential chemical contamination or electrical interference, or conditions or uses not described in this catalog.
- Nuclear energy control systems, combustion systems, railroad systems, aviation systems, medical equipment, amusement machines, vehicles, safety equipment, and installations subject to separate industry or government regulations.
- Systems, machines, and equipment that could present a risk to life or property.

Please know and observe all prohibitions of use applicable to the products.

NEVER USE THE PRODUCTS FOR AN APPLICATION INVOLVING SERIOUS RISK TO LIFE OR PROPERTY WITHOUT ENSURING THAT THE SYSTEM AS A WHOLE HAS BEEN DESIGNED TO ADDRESS THE RISKS, AND THAT THE OMRON PRODUCTS ARE PROPERLY RATED AND INSTALLED FOR THE INTENDED USE WITHIN THE OVERALL EQUIPMENT OR SYSTEM.

PROGRAMMABLE PRODUCTS

OMRON shall not be responsible for the user's programming of a programmable product, or any consequence thereof.

Disclaimers

CHANGE IN SPECIFICATIONS

Product specifications and accessories may be changed at any time based on improvements and other reasons.

It is our practice to change model numbers when published ratings or features are changed, or when significant construction changes are made. However, some specifications of the products may be changed without any notice. When in doubt, special model numbers may be assigned to fix or establish key specifications for your application on your request. Please consult with your OMRON representative at any time to confirm actual specifications of purchased products.

DIMENSIONS AND WEIGHTS

Dimensions and weights are nominal and are not to be used for manufacturing purposes, even when tolerances are shown.

PERFORMANCE DATA

Performance data given in this catalog is provided as a guide for the user in determining suitability and does not constitute a warranty. It may represent the result of OMRON's test conditions, and the users must correlate it to actual application requirements. Actual performance is subject to the OMRON Warranty and Limitations of Liability.

ERRORS AND OMISSIONS

The information in this document has been carefully checked and is believed to be accurate; however, no responsibility is assumed for clerical, typographical, or proofreading errors, or omissions.

2008.11

In the interest of product improvement, specifications are subject to change without notice.

OMRON Corporation
Industrial Automation Company

<http://www.ia.omron.com/>

(c)Copyright OMRON Corporation 2008 All Right Reserved.

Компания «Океан Электроники» предлагает заключение долгосрочных отношений при поставках импортных электронных компонентов на взаимовыгодных условиях!

Наши преимущества:

- Поставка оригинальных импортных электронных компонентов напрямую с производств Америки, Европы и Азии, а так же с крупнейших складов мира;
- Широкая линейка поставок активных и пассивных импортных электронных компонентов (более 30 млн. наименований);
- Поставка сложных, дефицитных, либо снятых с производства позиций;
- Оперативные сроки поставки под заказ (от 5 рабочих дней);
- Экспресс доставка в любую точку России;
- Помощь Конструкторского Отдела и консультации квалифицированных инженеров;
- Техническая поддержка проекта, помощь в подборе аналогов, поставка прототипов;
- Поставка электронных компонентов под контролем ВП;
- Система менеджмента качества сертифицирована по Международному стандарту ISO 9001;
- При необходимости вся продукция военного и аэрокосмического назначения проходит испытания и сертификацию в лаборатории (по согласованию с заказчиком);
- Поставка специализированных компонентов военного и аэрокосмического уровня качества (Xilinx, Altera, Analog Devices, Intersil, Interpoint, Microsemi, Actel, Aeroflex, Peregrine, VPT, Syfer, Eurofarad, Texas Instruments, MS Kennedy, Miteq, Cobham, E2V, MA-COM, Hittite, Mini-Circuits, General Dynamics и др.);

Компания «Океан Электроники» является официальным дистрибьютором и эксклюзивным представителем в России одного из крупнейших производителей разъемов военного и аэрокосмического назначения «JONHON», а так же официальным дистрибьютором и эксклюзивным представителем в России производителя высокотехнологичных и надежных решений для передачи СВЧ сигналов «FORSTAR».



JONHON

«JONHON» (основан в 1970 г.)

Разъемы специального, военного и аэрокосмического назначения:

(Применяются в военной, авиационной, аэрокосмической, морской, железнодорожной, горно- и нефтедобывающей отраслях промышленности)

«FORSTAR» (основан в 1998 г.)

ВЧ соединители, коаксиальные кабели,
кабельные сборки и микроволновые компоненты:

(Применяются в телекоммуникациях гражданского и специального назначения, в средствах связи, РЛС, а так же военной, авиационной и аэрокосмической отраслях промышленности).



Телефон: 8 (812) 309-75-97 (многоканальный)

Факс: 8 (812) 320-03-32

Электронная почта: ocean@oceanchips.ru

Web: <http://oceanchips.ru/>

Адрес: 198099, г. Санкт-Петербург, ул. Калинина, д. 2, корп. 4, лит. А