

## Product Summary

$V_{(BR)DSS}$	$R_{DS(on)}$ max	$I_D$ $T_A = +25^\circ\text{C}$
20V	0.4Ω @ $V_{GS} = 4.5\text{V}$	1.5A
	0.5 Ω @ $V_{GS} = 2.5\text{V}$	1.3A
	0.7 Ω @ $V_{GS} = 1.8\text{V}$	1.1A

## Features and Benefits

- Low On-Resistance
- Very Low Gate Threshold Voltage  $V_{GS(TH)}$ , 1.0V Max.
- Low Input Capacitance
- Fast Switching Speed
- Ultra-Small Surfaced Mount Package
- Ultra-Low Package Profile, 0.4mm Maximum Package Height
- ESD Protected Gate
- **Totally Lead-Free & Fully RoHS compliant (Notes 1 & 2)**
- **Halogen and Antimony Free. "Green" Device (Note 3)**
- **Qualified to AEC-Q101 Standards for High Reliability**

## Description and Applications

This new generation MOSFET is designed to minimize the on-state resistance ( $R_{DS(on)}$ ) and yet maintain superior switching performance, making it ideal for high efficiency power management applications.

- DC-DC Converters
- Power Management Functions

## Mechanical Data

- Case: X2-DFN1006-3
- Case Material: Molded Plastic, "Green" Molding Compound; UL Flammability Classification Rating 94V-0
- Moisture Sensitivity: Level 1 per J-STD-020
- Terminal Connections: See Diagram
- Terminals: Finish – NiPdAu over Copper Leadframe; Solderable per MIL-STD-202, Method 208④
- Weight: 0.001 grams (Approximate)



X2-DFN1006-3

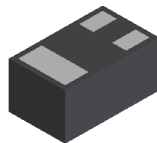

Bottom View

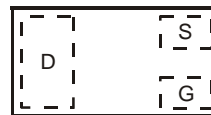
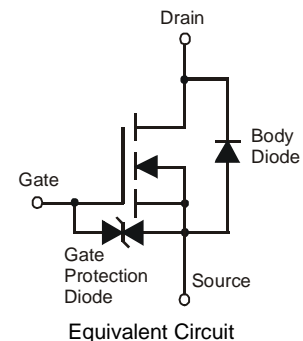

 Top View  
Internal Schematic

## Ordering Information (Note 4)

Part Number	Case	Packaging
DMN2501UFB4-7	X2-DFN1006-3	3,000/Tape & Reel
DMN2501UFB4-7B	X2-DFN1006-3	10,000/Tape & Reel

- Notes:
1. No purposely added lead. Fully EU Directive 2002/95/EC (RoHS) & 2011/65/EU (RoHS 2) compliant.
  2. See [http://www.diodes.com/quality/lead\\_free.html](http://www.diodes.com/quality/lead_free.html) for more information about Diodes Incorporated's definitions of Halogen and Antimony free, "Green" and Lead-Free.
  3. Halogen and Antimony free "Green" products are defined as those which contain <900ppm bromine, <900ppm chlorine (<1500ppm total Br + Cl) and <1000ppm antimony compounds.
  4. For packaging details, go to our website at <http://www.diodes.com>.

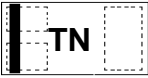
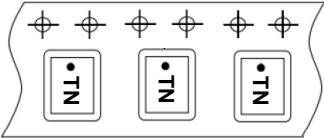
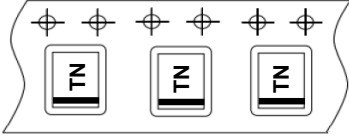
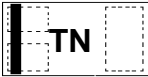
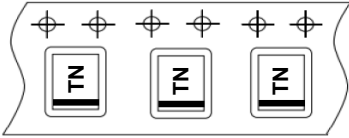
**Marking Information**

<p><b>DMN2501UFB4-7</b></p>	<div style="display: flex; justify-content: space-around;"> <div style="text-align: center;">  <p>Top View Dot Denotes Drain Side</p> </div> <div style="text-align: center;"> <p>From date code 1527 (YYWW), this changes to:</p>  <p>Top View Bar Denotes Gate and Source Side</p> </div> </div> <div style="display: flex; justify-content: space-around; margin-top: 20px;">   </div>
<p><b>DMN2501UFB4-7B</b></p>	<div style="text-align: center;">  <p>Top View Bar Denotes Gate and Source Side</p> </div> <div style="text-align: center; margin-top: 20px;">  </div> <div style="text-align: right; margin-top: 20px;"> <p>TN = Part Marking Code</p> </div>

**Maximum Ratings** (@T<sub>A</sub> = +25°C, unless otherwise specified.)

Characteristic		Symbol	Value	Units	
Drain-Source Voltage		V <sub>DSS</sub>	20	V	
Gate-Source Voltage		V <sub>GSS</sub>	±8	V	
Continuous Drain Current (Note 5) V <sub>GS</sub> = 4.5V	Steady State	I <sub>D</sub>	T <sub>A</sub> = 25°C T <sub>A</sub> = 70°C	1.0 0.8	A
	t < 10s		T <sub>A</sub> = 25°C T <sub>A</sub> = 70°C	1.2 0.9	A
Continuous Drain Current (Note 6) V <sub>GS</sub> = 4.5V	Steady State	I <sub>D</sub>	T <sub>A</sub> = 25°C T <sub>A</sub> = 70°C	1.5 1.2	A
	t < 10s		T <sub>A</sub> = 25°C T <sub>A</sub> = 70°C	1.8 1.4	A
Pulsed Drain Current (10µs pulse, duty cycle = 1%)		I <sub>DM</sub>	6	A	
Maximum Body Diode continuous Current		I <sub>S</sub>	1	A	

**Thermal Characteristics** (@T<sub>A</sub> = +25°C, unless otherwise specified.)

Characteristic		Symbol	Value	Units
Total Power Dissipation (Note 5)	T <sub>A</sub> = +25°C	P <sub>D</sub>	0.5	W
	T <sub>A</sub> = +70°C		0.3	
Thermal Resistance, Junction to Ambient (Note 5)	Steady State	R <sub>θJA</sub>	251	°C/W
	t < 10s		188	
Total Power Dissipation (Note 6)	T <sub>A</sub> = +25°C	P <sub>D</sub>	1.2	W
	T <sub>A</sub> = +70°C		0.7	
Thermal Resistance, Junction to Ambient (Note 6)	Steady State	R <sub>θJA</sub>	110	°C/W
	t < 10s		82	
Operating and Storage Temperature Range		T <sub>J</sub> , T <sub>STG</sub>	-55 to +150	°C

Notes: 5. Device mounted on FR-4 substrate PC board, 2oz copper, with minimum recommended pad layout.  
6. Device mounted on FR-4 substrate PC board, 2oz copper, with 1-inch square copper plate.

**Electrical Characteristics** (@T<sub>A</sub> = +25°C, unless otherwise specified.)

Characteristic	Symbol	Min	Typ	Max	Unit	Test Condition
<b>OFF CHARACTERISTICS (Note 7)</b>						
Drain-Source Breakdown Voltage	BV <sub>DSS</sub>	20	-	-	V	V <sub>GS</sub> = 0V, I <sub>D</sub> = 250μA
Zero Gate Voltage Drain Current T <sub>J</sub> = +25°C	I <sub>DSS</sub>	-	-	100	nA	V <sub>DS</sub> = 20V, V <sub>GS</sub> = 0V
Gate-Source Leakage	I <sub>GSS</sub>	-	-	±1	μA	V <sub>GS</sub> = ±6V, V <sub>DS</sub> = 0V
<b>ON CHARACTERISTICS (Note 7)</b>						
Gate Threshold Voltage	V <sub>GS(th)</sub>	0.5	0.76	1.0	V	V <sub>DS</sub> = V <sub>GS</sub> , I <sub>D</sub> = 250μA
Static Drain-Source On-Resistance	R <sub>DS(on)</sub>	-	170	400	mΩ	V <sub>GS</sub> = 4.5V, I <sub>D</sub> = 600mA
			200	500		V <sub>GS</sub> = 2.5V, I <sub>D</sub> = 500mA
			260	700		V <sub>GS</sub> = 1.8V, I <sub>D</sub> = 350mA
Forward Transfer Admittance	Y <sub>fs</sub>	-	1.4	-	S	V <sub>DS</sub> = 10V, I <sub>D</sub> = 400mA
Diode Forward Voltage	V <sub>SD</sub>		0.7	1.2	V	V <sub>GS</sub> = 0V, I <sub>S</sub> = 150mA
<b>DYNAMIC CHARACTERISTICS (Note 8)</b>						
Input Capacitance	C <sub>iSS</sub>	-	82	-	pF	V <sub>DS</sub> = 16V, V <sub>GS</sub> = 0V, f = 1.0MHz
Output Capacitance	C <sub>oss</sub>	-	12	-	pF	
Reverse Transfer Capacitance	C <sub>rSS</sub>	-	10	-	pF	
Gate resistance	R <sub>g</sub>	-	83	-	Ω	V <sub>DS</sub> = 0V, V <sub>GS</sub> = 0V, f = 1.0MHz
Total Gate Charge (V <sub>GS</sub> = 4.5V)	Q <sub>g</sub>	-	1.1	-	nC	V <sub>DS</sub> = 10V, I <sub>D</sub> = 250mA
Total Gate Charge (V <sub>GS</sub> = 10V)	Q <sub>g</sub>	-	2.0	-	nC	
Gate-Source Charge	Q <sub>gs</sub>	-	0.14	-	nC	
Gate-Drain Charge	Q <sub>gd</sub>	-	0.19	-	nC	
Turn-On Delay Time	t <sub>D(on)</sub>	-	6.6	-	ns	
Turn-On Rise Time	t <sub>r</sub>	-	6.4	-	ns	V <sub>DD</sub> = 10V, V <sub>GS</sub> = 4.5V, R <sub>L</sub> = 47Ω, R <sub>G</sub> = 10Ω, I <sub>D</sub> = 200mA
Turn-Off Delay Time	t <sub>D(off)</sub>	-	40.4	-	ns	
Turn-Off Fall Time	t <sub>f</sub>	-	17.3	-	ns	

Notes: 7. Short duration pulse test used to minimize self-heating effect.  
8. Guaranteed by design. Not subject to product testing.

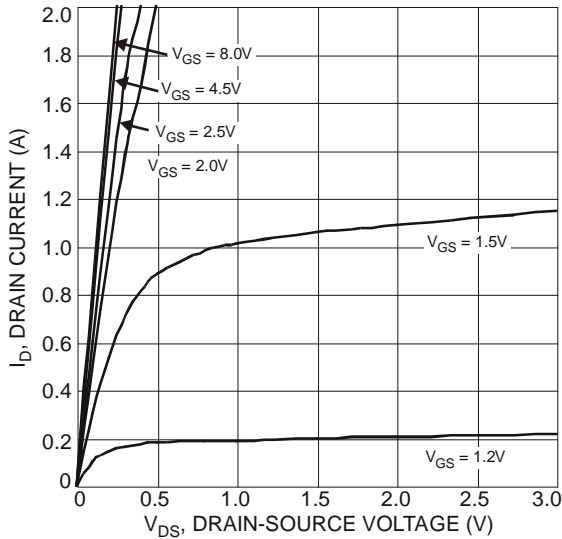

Fig. 1 Typical Output Characteristic

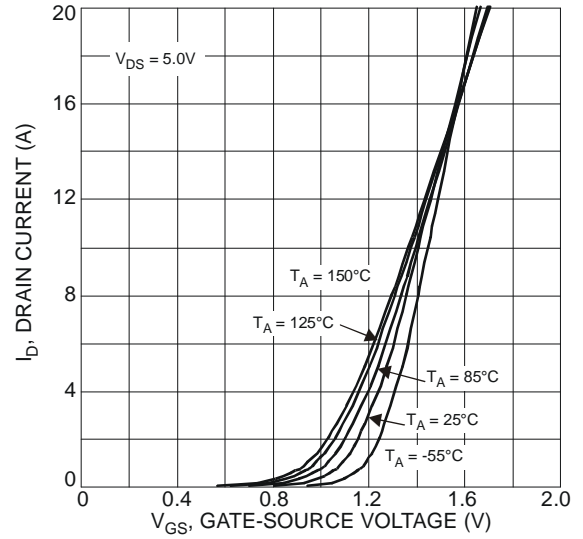

Fig. 2 Typical Transfer Characteristics

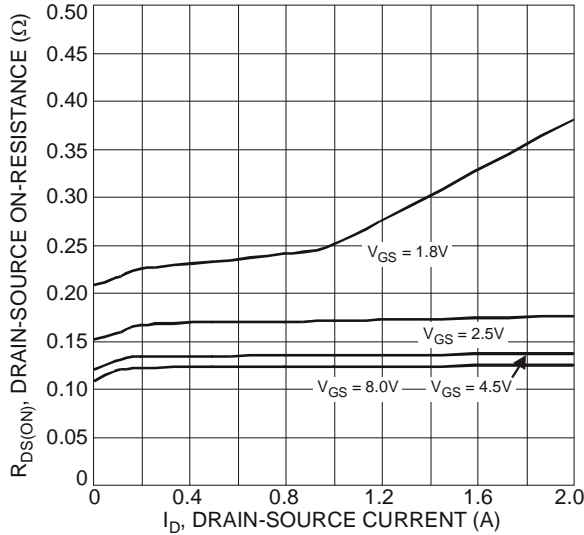

Fig. 3 Typical On-Resistance vs. Drain Current and Gate Voltage

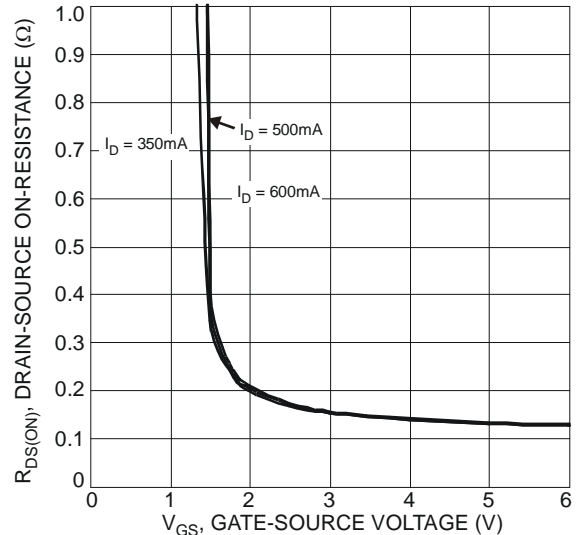

Fig. 4 Typical Drain-Source On-Resistance vs. Gate-Source Voltage

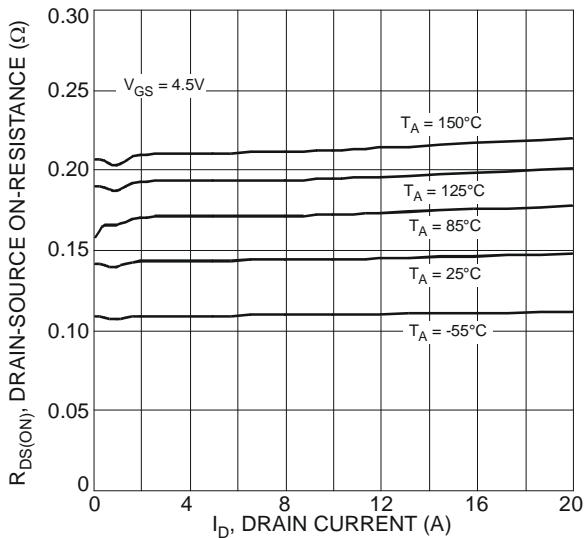

Fig. 5 Typical On-Resistance vs. Drain Current and Temperature

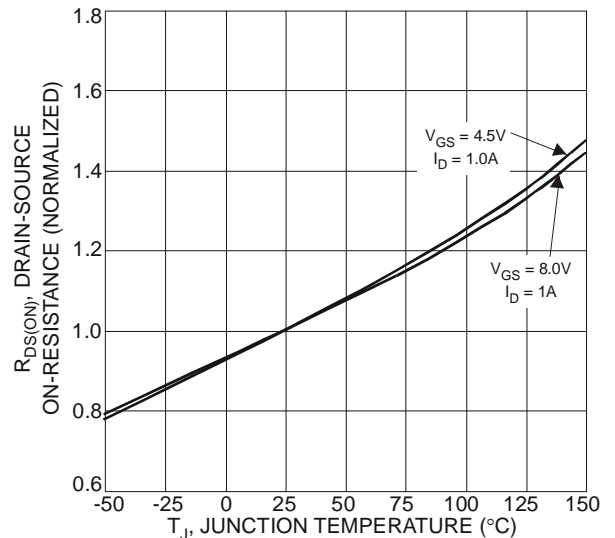

Fig. 6 On-Resistance Variation with Temperature

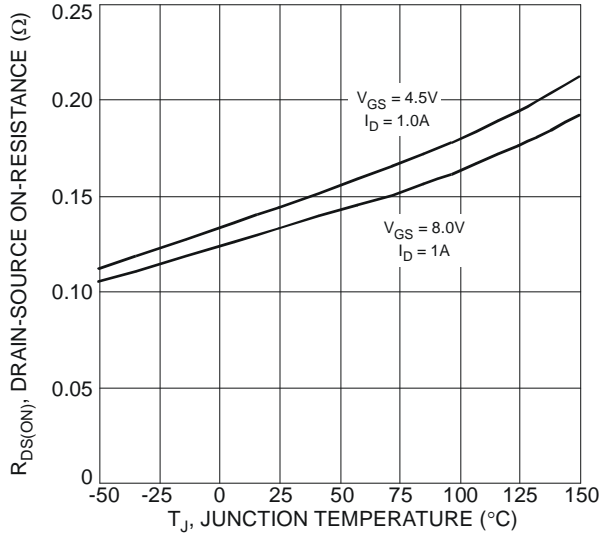

Fig. 7 On-Resistance Variation with Temperature

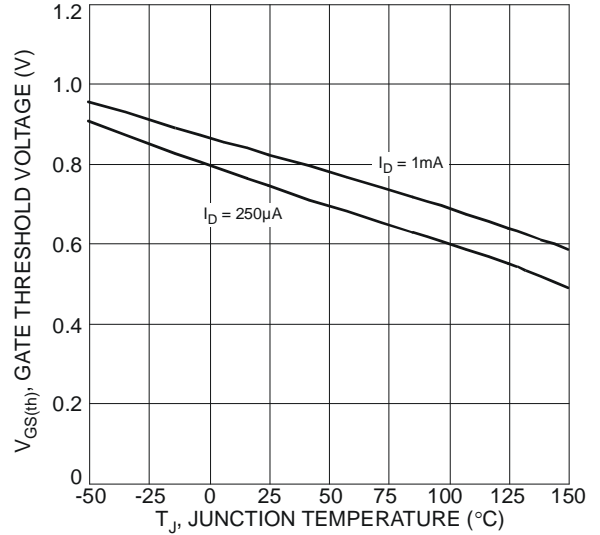

Fig. 8 Gate Threshold Variation vs. Ambient Temperature

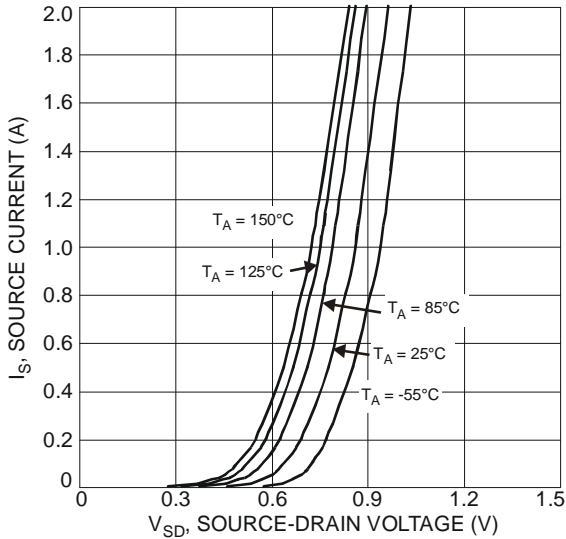

Fig. 9 Diode Forward Voltage vs. Current

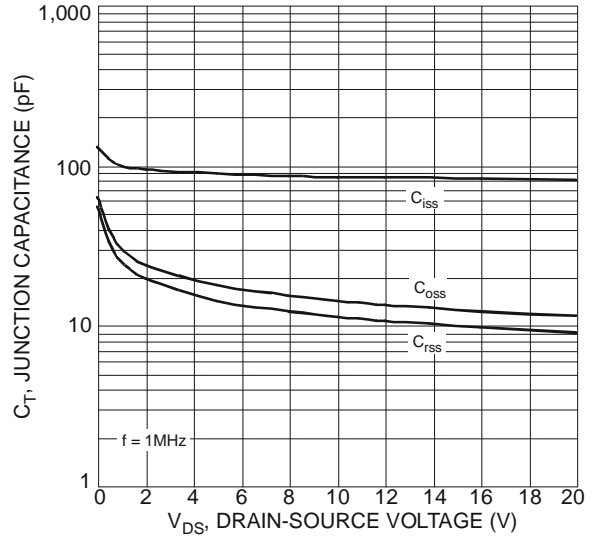

Fig. 10 Typical Junction Capacitance

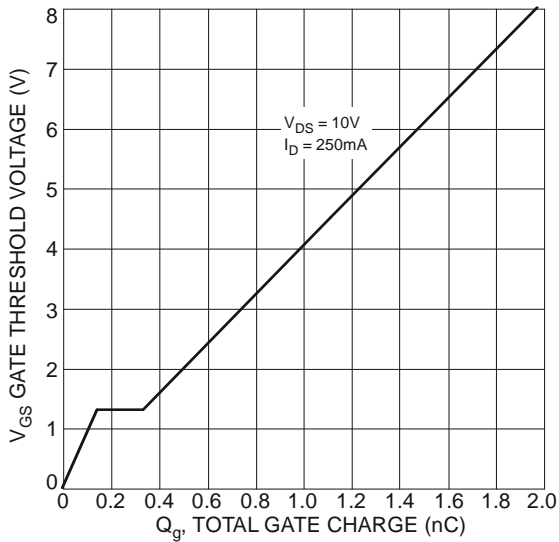

Fig. 11 Gate Charge

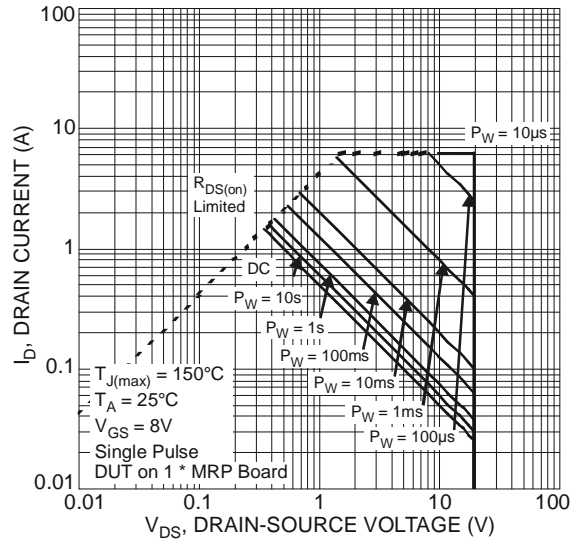
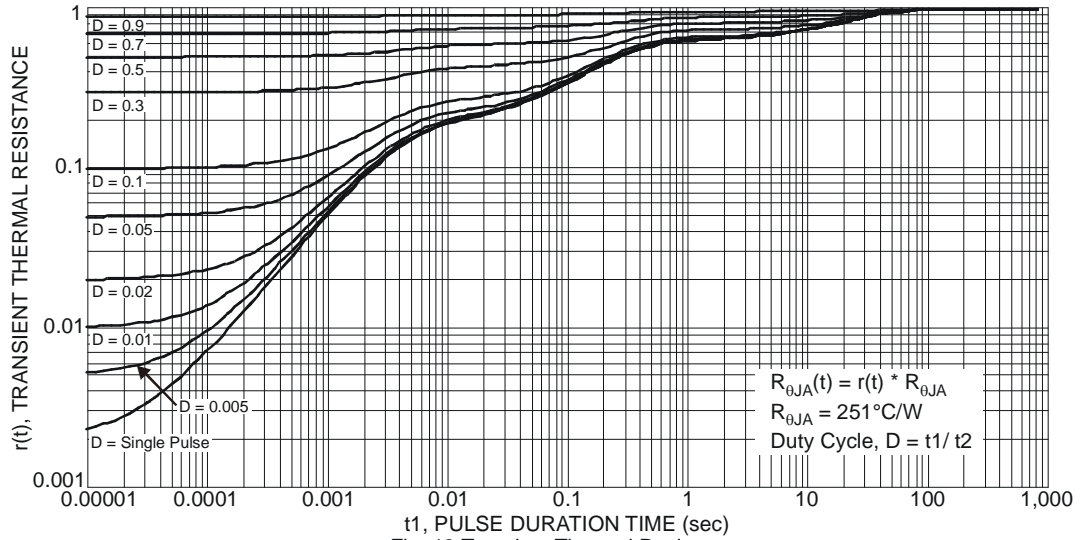
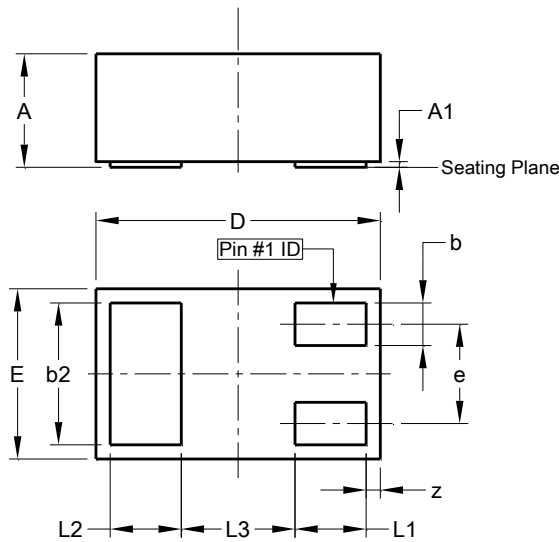

Fig. 12 SOA, Safe Operation Area



**Package Outline Dimensions**

Please see AP02002 at <http://www.diodes.com/datasheets/ap02002.pdf> for latest version.



X2-DFN1006-3			
Dim	Min	Max	Typ
A	—	0.40	—
A1	0.00	0.05	0.03
b	0.10	0.20	0.15
b2	0.45	0.55	0.50
D	0.95	1.05	1.00
E	0.55	0.65	0.60
e	-	-	0.35
L1	0.20	0.30	0.25
L2	0.20	0.30	0.25
L3	-	-	0.40
z	0.02	0.08	0.05
All Dimensions in mm			

**Suggested Pad Layout**

Please see AP02001 at <http://www.diodes.com/datasheets/ap02001.pdf> for the latest version.

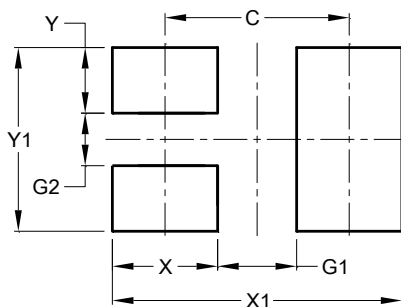

Dimensions	Value (in mm)
C	0.70
G1	0.30
G2	0.20
X	0.40
X1	1.10
Y	0.25
Y1	0.70

#### IMPORTANT NOTICE

DIODES INCORPORATED MAKES NO WARRANTY OF ANY KIND, EXPRESS OR IMPLIED, WITH REGARDS TO THIS DOCUMENT, INCLUDING, BUT NOT LIMITED TO, THE IMPLIED WARRANTIES OF MERCHANTABILITY AND FITNESS FOR A PARTICULAR PURPOSE (AND THEIR EQUIVALENTS UNDER THE LAWS OF ANY JURISDICTION).

Diodes Incorporated and its subsidiaries reserve the right to make modifications, enhancements, improvements, corrections or other changes without further notice to this document and any product described herein. Diodes Incorporated does not assume any liability arising out of the application or use of this document or any product described herein; neither does Diodes Incorporated convey any license under its patent or trademark rights, nor the rights of others. Any Customer or user of this document or products described herein in such applications shall assume all risks of such use and will agree to hold Diodes Incorporated and all the companies whose products are represented on Diodes Incorporated website, harmless against all damages.

Diodes Incorporated does not warrant or accept any liability whatsoever in respect of any products purchased through unauthorized sales channel. Should Customers purchase or use Diodes Incorporated products for any unintended or unauthorized application, Customers shall indemnify and hold Diodes Incorporated and its representatives harmless against all claims, damages, expenses, and attorney fees arising out of, directly or indirectly, any claim of personal injury or death associated with such unintended or unauthorized application.

Products described herein may be covered by one or more United States, international or foreign patents pending. Product names and markings noted herein may also be covered by one or more United States, international or foreign trademarks.

This document is written in English but may be translated into multiple languages for reference. Only the English version of this document is the final and determinative format released by Diodes Incorporated.

#### LIFE SUPPORT

Diodes Incorporated products are specifically not authorized for use as critical components in life support devices or systems without the express written approval of the Chief Executive Officer of Diodes Incorporated. As used herein:

A. Life support devices or systems are devices or systems which:

1. are intended to implant into the body, or
2. support or sustain life and whose failure to perform when properly used in accordance with instructions for use provided in the labeling can be reasonably expected to result in significant injury to the user.

B. A critical component is any component in a life support device or system whose failure to perform can be reasonably expected to cause the failure of the life support device or to affect its safety or effectiveness.

Customers represent that they have all necessary expertise in the safety and regulatory ramifications of their life support devices or systems, and acknowledge and agree that they are solely responsible for all legal, regulatory and safety-related requirements concerning their products and any use of Diodes Incorporated products in such safety-critical, life support devices or systems, notwithstanding any devices- or systems-related information or support that may be provided by Diodes Incorporated. Further, Customers must fully indemnify Diodes Incorporated and its representatives against any damages arising out of the use of Diodes Incorporated products in such safety-critical, life support devices or systems.

Copyright © 2015, Diodes Incorporated

[www.diodes.com](http://www.diodes.com)

Компания «Океан Электроники» предлагает заключение долгосрочных отношений при поставках импортных электронных компонентов на взаимовыгодных условиях!

Наши преимущества:

- Поставка оригинальных импортных электронных компонентов напрямую с производств Америки, Европы и Азии, а так же с крупнейших складов мира;
- Широкая линейка поставок активных и пассивных импортных электронных компонентов (более 30 млн. наименований);
- Поставка сложных, дефицитных, либо снятых с производства позиций;
- Оперативные сроки поставки под заказ (от 5 рабочих дней);
- Экспресс доставка в любую точку России;
- Помощь Конструкторского Отдела и консультации квалифицированных инженеров;
- Техническая поддержка проекта, помощь в подборе аналогов, поставка прототипов;
- Поставка электронных компонентов под контролем ВП;
- Система менеджмента качества сертифицирована по Международному стандарту ISO 9001;
- При необходимости вся продукция военного и аэрокосмического назначения проходит испытания и сертификацию в лаборатории (по согласованию с заказчиком);
- Поставка специализированных компонентов военного и аэрокосмического уровня качества (Xilinx, Altera, Analog Devices, Intersil, Interpoint, Microsemi, Actel, Aeroflex, Peregrine, VPT, Syfer, Eurofarad, Texas Instruments, MS Kennedy, Miteq, Cobham, E2V, MA-COM, Hittite, Mini-Circuits, General Dynamics и др.);

Компания «Океан Электроники» является официальным дистрибьютором и эксклюзивным представителем в России одного из крупнейших производителей разъемов военного и аэрокосмического назначения «JONHON», а так же официальным дистрибьютором и эксклюзивным представителем в России производителя высокотехнологичных и надежных решений для передачи СВЧ сигналов «FORSTAR».



## JONHON

«JONHON» (основан в 1970 г.)

Разъемы специального, военного и аэрокосмического назначения:

(Применяются в военной, авиационной, аэрокосмической, морской, железнодорожной, горно- и нефтедобывающей отраслях промышленности)

«FORSTAR» (основан в 1998 г.)

ВЧ соединители, коаксиальные кабели,  
кабельные сборки и микроволновые компоненты:

(Применяются в телекоммуникациях гражданского и специального назначения, в средствах связи, РЛС, а так же военной, авиационной и аэрокосмической отраслях промышленности).



Телефон: 8 (812) 309-75-97 (многоканальный)

Факс: 8 (812) 320-03-32

Электронная почта: [ocean@oceanchips.ru](mailto:ocean@oceanchips.ru)

Web: <http://oceanchips.ru/>

Адрес: 198099, г. Санкт-Петербург, ул. Калинина, д. 2, корп. 4, лит. А