

NEW

## SMART Sensor Series

Laser Displacement Sensor CMOS Type

Model ZX2 Series

# Stable, Easy & Affordable



# One Solution for Any Application



## New Laser Displacement Sensor CMOS Type ZX2 Series

Realize stable measurements  
**Resolution 1.5 $\mu$ m<sup>\*1</sup>**

Reliable measurement of moving objects  
**Measurement cycle 30 $\mu$ s**

Realize stable measurements at 10 $\mu$ m  
**Linearity<sup>\*2</sup> 0.05% F.S.<sup>\*3</sup>**

Unaffected by environmental changes  
**Temperature characteristic<sup>\*4</sup> 0.02% F.S./ $^{\circ}$ C<sup>\*5</sup>**

\*1 When employing Models ZX2-LD50/LD50L (50mm type)

\*2 Linearity : Maximum error produced when measuring within measurement range

\*3 Linearity  $\pm 0.05\%$  F.S. indicates the maximum error is 10 $\mu$ m in the case of using Model ZX2-LD50L with a 40-50mm measurement range.

\*4 Temperature characteristic : Error produced when the ambient temperature varies by 1 $^{\circ}$ C

\*5 Linearity  $\pm 0.02\%$  F.S./ $^{\circ}$ C indicates the maximum error is 4 $\mu$ m when the ambient temperature varies by 1 $^{\circ}$ C in the case of using Models ZX2-LD50/LD50L with a measurement range  $\pm 10$ mm.



# Stable Measurement and Easy to Use

## Stability Stable measurements in case of color/material and moving objects

### Dynamic range a million times

Realizes stable measurements for any color or surface condition including metals, substrates, elastomers and transparent materials through the employment of Omron's own HSDR-CMOS (High Speed and Dynamic Range) image sensor and a step-less laser power adjustment algorithm. A line beam is used in addition to an emitter beam, ideally configured with a Omron sensor lens. Stable measurements are thereby realized, in moving applications.

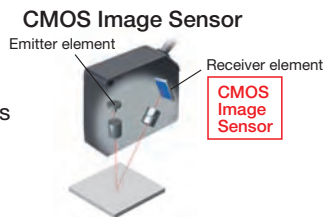

### Step-less adjustment of laser power

For high reflectance, brightly colored workpiece

For low reflectance, darkly colored workpiece

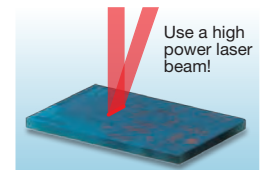
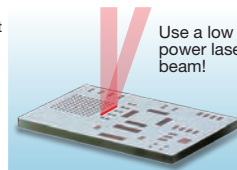

PAT.P

### Stable measurements on objects with changing color/material

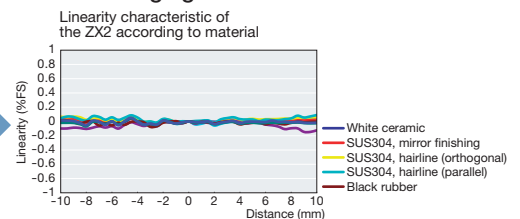
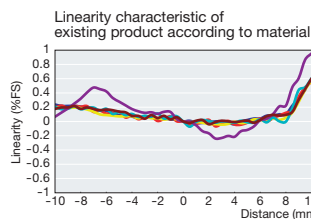

### Stable measurements on moving objects

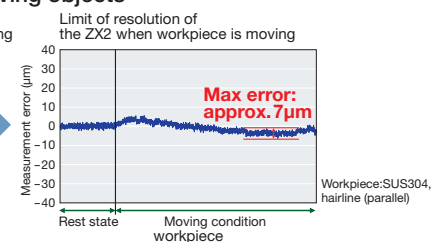
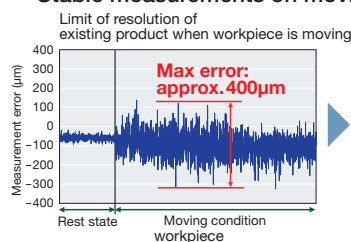

## Easy Easy and User-friendly Configuration

### Smart tuning

The ideal configuration for stable measurements is realized by a single button through the new feature "smart tuning", and no longer depends on the skill of the user. A reliable configuration is achieved by three tuning methods, which can be selected to match the type of object and surface conditions to be measured.

Sensor configuration by just a pushing the SMART button

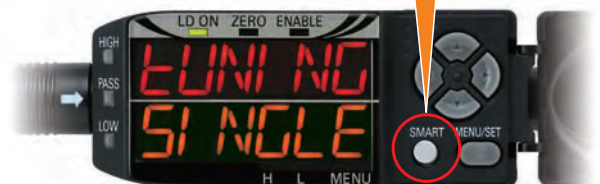

PAT.P

### Three selectable tunings

#### One type of workpiece



**Single smart tuning**  
Best configuration for stable detection in case of objects do not change by pushing the button for one second

#### Several types of workpiece



**Multi-smart tuning**  
Ideal configuration for stable detection of changing objects by pushing the button for three seconds

#### Surface conditions of the workpiece are variable

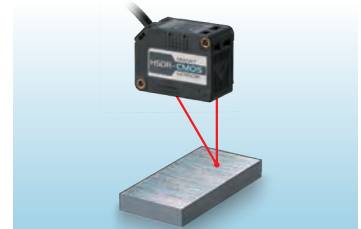

**Active smart tuning**  
Continuous configuration improvement for the stable detection of all locations by pushing the button for five seconds

# Sensor Heads for Various Applications -select the Range and Type of Beam

**ZX2-LD50L** Line beam type  
**ZX2-LD50** Spot beam type

● Measurement range	50mm±10mm
● Resolution	1.5µm
● Linearity	Line beam ±0.05%F.S.*1 Spot beam ±0.10%F.S.*1
● Beam size	Line beam Approx.60µm×2.6mm Spot beam Approx.60µm dia.

## Spot beam

Precise measurement on micro-scale objects

**ZX2-LD100L** Line beam type  
**ZX2-LD100** Spot beam type

● Measurement range	100mm±35mm
● Resolution	5µm
● Linearity	Line beam ±0.05%F.S.*2 Spot beam ±0.10%F.S.*2
● Beam size	Line beam Approx.110µm×2.7mm Spot beam Approx.110µm dia.

## Line beam

Stable measurement on rough-surfaced objects



\*1 Using 40 to 50mm

\*2 Using 65 to 100mm



# Support for Various Environments/Space-Saving ●●● The Smart Sensor Head

## Reliable measurements in harsh environments

IP67, robot cable & temperature characteristic 0.02% F.S./°C

IP67 protection class enables to use the sensor in harsh environments. A robot cable is used as standard between the head and amplifier, that the unit can be used reliably on moving parts. In addition, as 3D UV bond is used to fix the optical components rather than screws, stress can be controlled and a temperature characteristic 0.02% F.S./°C\* is realized.

\* If the room temperature varies 1°C, the measured value varies 0.02% F.S. (corresponding to 4μm for the Model ZX2-LD50)



## Compact sensor for easy mounting

World smallest\*

The world's smallest CMOS laser displacement sensor head is realized in a resin case. Enables to mount the sensor in smallest spaces and to minimize measurement errors arising from temperature fluctuations.

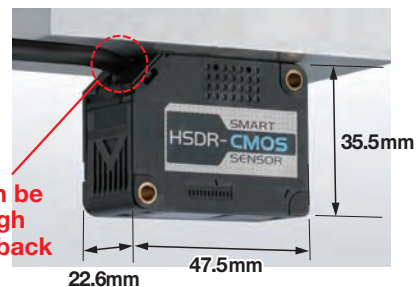

## 10μm precision measurements

Linearity to meet the application

Measurements to an even higher accuracy are realized for applications that do not require the entire measurement range. If the range of the field is less than the length of the measurement center, linearity accuracy improves by 50% compared with that for the full range.\*

\* Model ZX2-LD□□

Model ZX2-LD50L

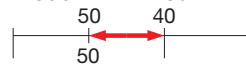

Linearity  $\pm 0.05\%$  F.S.

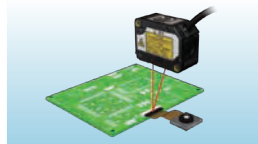

Example of an application that does not require the entire measurement range  
Low-profile connector assembly height measurement

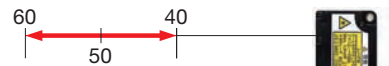

Linearity  $\pm 0.1\%$  F.S.

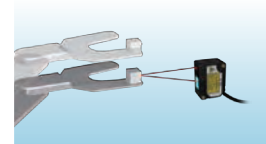

Example of an application that requires the entire measurement range  
Robot hand registration

## Visualization to prevent from stopping the production-line

Laser life display function

The end of the laser diode lifespan is automatically detected and displayed so maintenance can be performed systematically. On the main digital display of the amplifier, this is indicated by an LED on the back of the head. Accordingly, in case of amplifier is within the control panel, the lifetime can be confirmed by the head and the indications are not missed.



# Ease of Use by “LED Display” and “Calculating Unit”

## 11-segment LED display for intuitive configuration

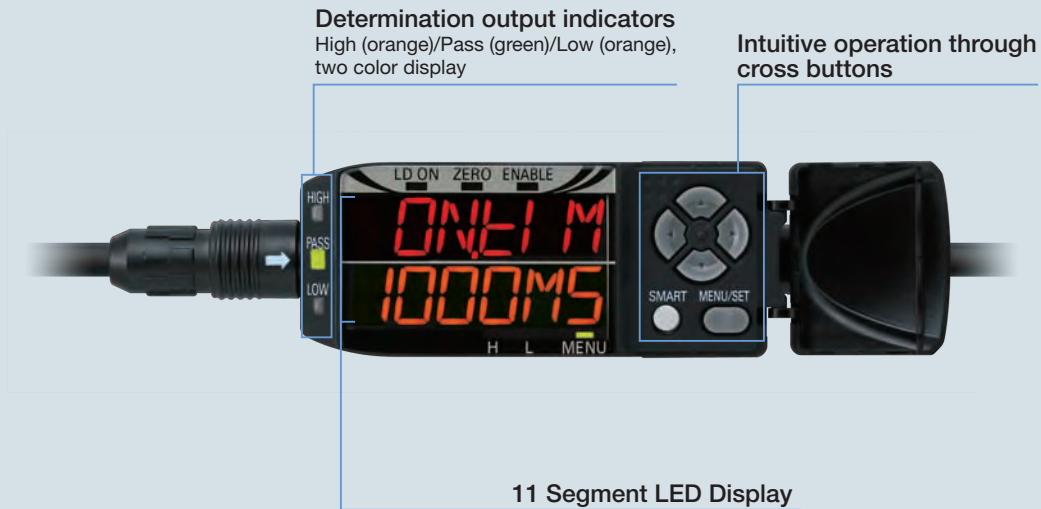

## Easy calculations of measurements

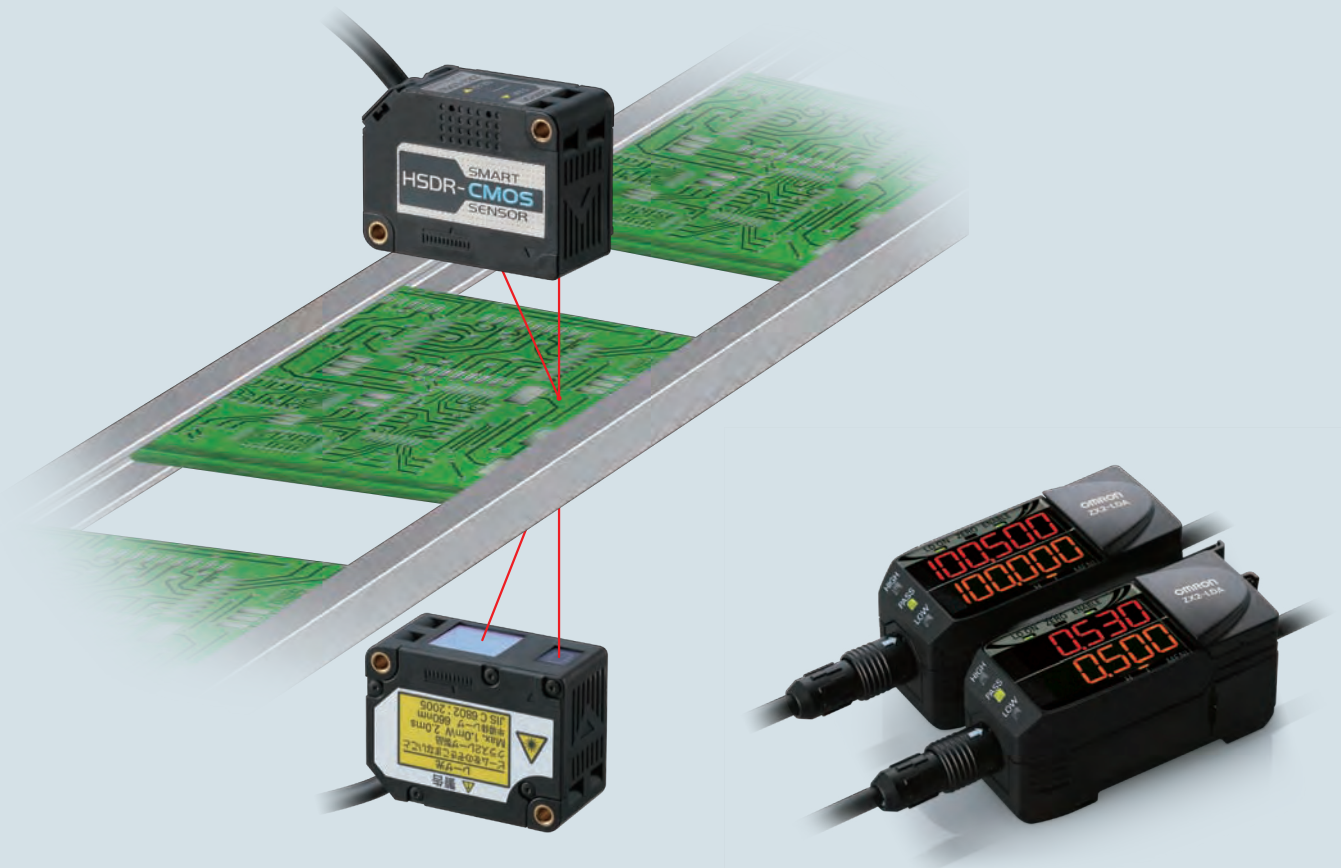



# A thorough pursuit of user-friendliness ●●● The Smart Amplifier Unit

## No need for a manual

### 11 Segment LED Display

An 11 segment LED display is integrated in the compact housing. Alphanumeric characters can be read with ease and there is no need to refer to a manual.



Comparison of the existing 7 segment LED display and the 11 segment LED display

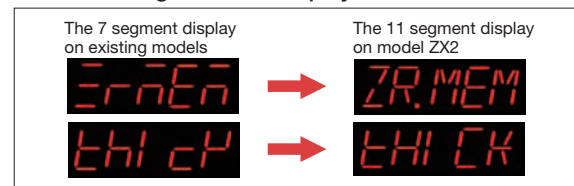

The compact housing stays just as it is

## Perform two calculations with ease

### Thickness + subtraction mode

The calculated results of two sensors are displayed on the amplifier by just connecting the calculating unit between the two amplifiers. The calculation function can be chosen from the two modes of thickness and subtraction. It is also possible to prevent mutual interference by coupling via the calculating units.

#### Thickness mode

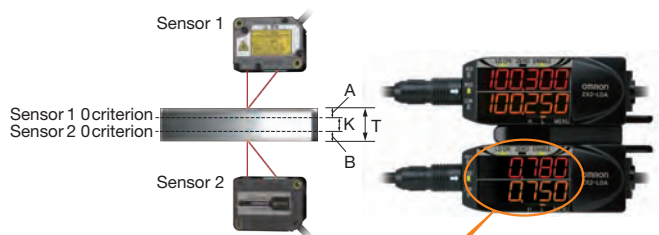

Thickness  $T = K + (A + B)$

#### Subtraction mode

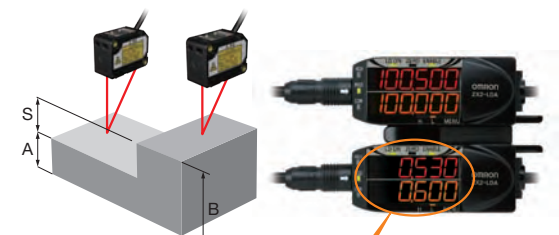

Level difference  $S = B - A$

## Easy change of setup

### Equipped with 4 banks

The amplifier unit is equipped with four bank functions. Easy change of setup between four modes is supported by just switching between the bank functions.

Existing models



Amplifier unit + Bank unit

ZX2



Built into the unit

# One Sensor for Any Measurement Application

## Height/ Length

Height measurements prior to IC package sealing

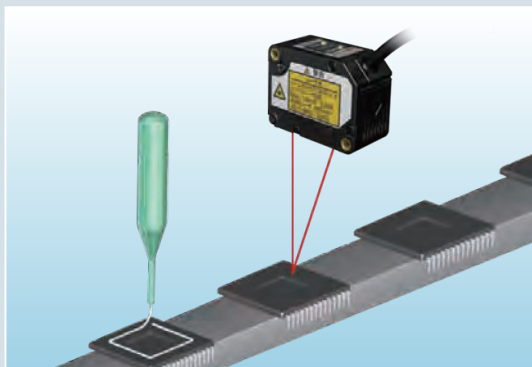

### Point

Stable measurements can be performed by the HSDR-CMOS image sensor and Omron's proprietary algorithm, even for measurements on moving IC packages.

## Level detection

Shape validation for molded parts

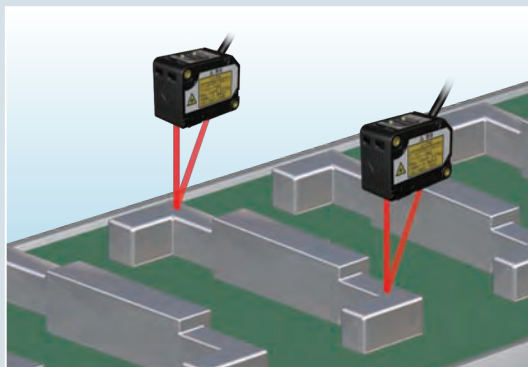

### Point

Calculation of the measured values can be carried out and the difference in level can be easily measured by just connecting the calculating unit between two amplifiers. Even if the surface conditions of a molded part varies, application of a line beam and HSDR-CMOS image sensor results in almost no fluctuation in measured value.

## Warpage

Tray flatness measurement prior to chip firing

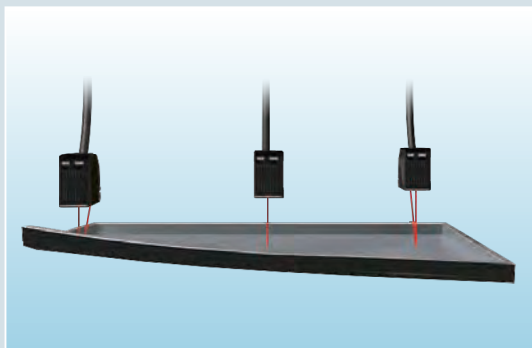

### Point

Even if there is temperature variation due to the ambient temperature, a die-cast is used for the optical base and so there is almost no fluctuation in measured value.

## Positioning

Robot hand Positioning

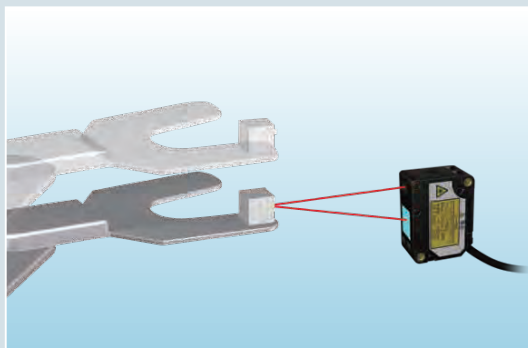

### Point

Stable measurements can be performed by the HSDR-CMOS image sensor and Omron's proprietary algorithm even for robot hand registration.

## Double feed

PCB double feed detection

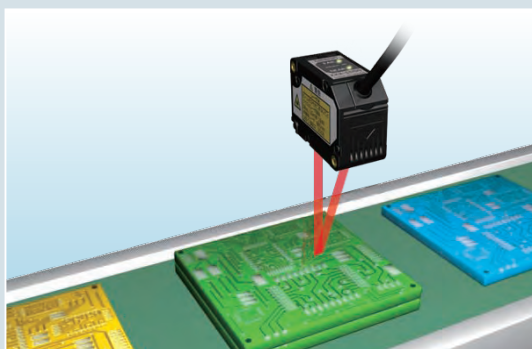

### Point

Even if the color of the substrate changes, application of the HSDR-CMOS image sensor and Omron's proprietary algorithm results in almost no fluctuation in measured value.

## Thickness

Wafer thickness measurement

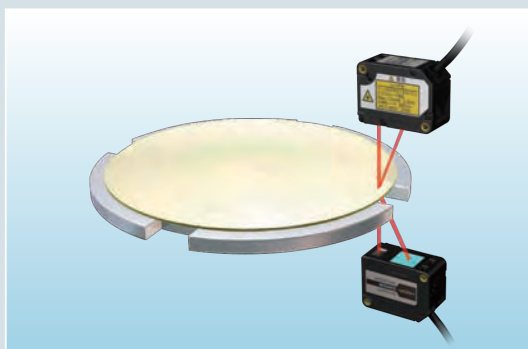

### Point

Calculation of the measured values can be carried out and the thickness can be easily measured by just connecting the calculating unit between two amplifiers.



# Ordering Information

## Units

### Sensor Heads

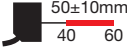
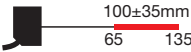
Appearance	Beam shape	Sensing distance	Resolution	Model
Diffuse reflection type 	Line beam	 50±10mm 40 60	1.5μm	ZX2-LD50L
	Spot beam			ZX2-LD50
	Line beam	 100±35mm 65 135	5μm	ZX2-LD100L
	Spot beam			ZX2-LD100

### Amplifier Units

Appearance	Power supply	Output type	Model
	DC	NPN	ZX2-LDA11
		PNP	ZX2-LDA41

**Accessories (sold separately)** These are not included with the Sensor Head or Amplifier Unit. Please order as necessary.

### Calculating Unit

Appearance	Model
	ZX2-CAL

### Sensor Head Extension Cables

Cable Length	Model
1m	ZX2-XC1R
4m	ZX2-XC4R
9m	ZX2-XC9R

\* Extension cables cannot be coupled and used together.

# Specifications

## Sensor Heads

Item	Model	ZX2-LD50L	ZX2-LD50	ZX2-LD100L	ZX2-LD100
Optical system		Diffuse reflective			
Light source (wave length)		Visible-light semiconductor laser with a wavelength of 660 nm and an output of 1mW max. EN class 2, FDA class II*5			
Measurement center point		50mm		100mm	
Measurement range		±10mm		±35mm	
Beam shape		Line	Spot	Line	Spot
Beam size *1		Approx. 60μm×2.6mm	Approx. 60μm dia.	Approx. 110μm×2.7mm	Approx. 110μm dia.
Resolution *2		1.5μm		5μm	
Linearity *3		±0.05%F.S. (40 to 50mm) ±0.1%F.S. (entire range)	±0.1%F.S. (40 to 50mm) ±0.15%F.S. (entire range)	±0.05%F.S. (65 to 100mm) ±0.1%F.S. (entire range)	±0.1%F.S. (65 to 100mm) ±0.15%F.S. (entire range)
Temperature characteristic *4		0.02%F.S./°C			
Ambient illumination		Incandescent lamp: 10,000lx max. (on light receiving side)			
Ambient temperature		Operating: 0 to +50°C, Storage: -15 to +70°C (with no icing or condensation)			
Ambient humidity		Operating and storage: 35% to 85% (with no condensation)			
Dielectric strength		1,000 VAC, 50/60 Hz for 1 min.			
Vibration resistance (destruction)		10 to 150 Hz, 0.7-mm double amplitude, 80 min. each in X, Y, and Z directions			
Shock resistance (destruction)		300 m/s <sup>2</sup> 3 times each in six directions (up/down, left/right, forward/backward)			
Degree of protection		IEC60529, IP67			
Connection method		Connector connection (standard cable length: 500 mm)			
Weight (packed state)		Approx. 160g (unit only: Approx. 75g)			
Materials		Case and cover: PBT (polybutylene terephthalate), Optical window: Glass, Cable: PVC			
Accessories		Instruction sheet, Ferrite core, Laser warning label (English)			

Note) False detection outside the measurement range can occur in the case of an object with high reflectance.

\*1. Beam size: Defined as 1/e<sup>2</sup> (13.5%) of the central intensity at the smallest value of diameter for the measurement range (typical value)

False detections can occur in the case there is light leakage outside the defined region and the surroundings of the target object have a high reflectance in comparison to the target object.

\*2. Resolution: indicates the degree of fluctuation (±3σ) of analog output when connected to the ZX2-LDA.

(Indicates the measured value for the case the response time of the ZX2-LDA is configured to 128ms and Omron's standard target object (white ceramics) is made the center distance.)

Indicates the repetition accuracy for when the workpiece is in a state of rest. Not an indication of distance accuracy. Resolution performance may not be satisfied in a strong electromagnetic field.

\*3. Linearity: indicates the error with respect to the ideal straight line of the displacement output in the case of measuring Omron's standard target object. Linearity and measured value may vary depending on target object.

F.S. indicates the full scope of the measurement range. (ZX2-LD50□: 20mm)

\*4. Temperature characteristic: Value for the case the space between the sensor head and Omron's standard target object is secured by an aluminum jig. (Measured at the measurement center distance)

\*5. Classified as Class 2 by EN60825-1 criteria in accordance with the FDA standard provisions of Laser Notice No.50. Notification to CDRH planned.

## Amplifier Units

Item	Model	ZX2-LDA11	ZX2-LDA41
Measurement period *1		Min. 30μs	
Response time		60μs, 120μs, 240μs, 500μs, 1ms, 2ms, 4ms, 8ms, 12ms, 20ms, 36ms, 66ms, 128ms, 250ms, 500ms	
Analog output *2		4 to 20 mA, Max. load resistance: 300Ω, ±5VDC or 1 to 5 VDC, Output impedance: 100Ω	
Judgement outputs (HIGH/PASS/LOW: 3 outputs), error output		NPN open-collector outputs, 30 VDC, 50 mA max. (residual voltage: 1V max. for load current 10mA max., 2V max. for load current above 10mA)	PNP open-collector outputs, 30 VDC, 50 mA max. (residual voltage: 1V max. for load current 10mA max., 2V max. for load current above 10mA)
Laser OFF input, zero reset input, timing input, reset input, bank input		ON: Short-circuited with 0-V terminal or 1.2V or less OFF: Open (leakage current: 0.1 mA max.)	ON: Supply voltage short-circuited or supply voltage within -1.2V OFF: Open (leakage current: 0.1 mA max.)
Functions		Smart tuning, scaling, sample hold, peak hold, bottom hold, peak-to-peak hold, self-peak hold, self-bottom hold, average hold, zero reset, On-delay timer, OFF-delay timer, keep/clamp switch, (A-B)calculations *3, thickness calculation *3, mutual interference prevention *3, laser deterioration detection, bank function(4 banks)	
Indications		Judgement indicators: HIGH(orange),PASS(green),LOW(orange),11-segment main display(red),11-segment sub-display(orange),laser ON(green),zero reset(green),enable(green),menu(green), HIGH threshold(orange),LOW threshold(orange)	
Power supply voltage		10 to 30 VDC, including 10% ripple(p-p)	
Power consumption		3,000 mW max. with power supply voltage of 30 VDC and power supply current of 100 mA (with Sensor connected)	
Ambient temperature		Operating: 0 to +50°C, Storage: -15 to +70°C (with no icing or condensation)	
Ambient humidity		Operating and storage: 35% to 85% (with no condensation)	
Dielectric strength		1,000 VAC, 50/60 Hz for 1 min.	
Vibration resistance (destruction)		10 to 150 Hz, 0.7-mm double amplitude, 80 min. each in X,Y,and Z directions	
Shock resistance (destruction)		300 m/s <sup>2</sup> 3 times each in six directions (up/down,left/right,forward/backward)	
Degree of protection		IEC60529, IP40	
Connection method		Prewired (standard cable length: 2 m)	
Weight (packed state)		Approx.200g (unit only: Approx.135g)	
Materials		Case: PBT(polybutylene terephthalate), Cover: Polycarbonate, Display: Acrylic resin, Button: Polyacetal, Cable: PVC	
Accessories		Instruction sheet	

\*1. In the case of Omron's standard target object (white ceramic)

\*2. Configure current output (4 to 20mA) and voltage output (±5V or 1 to 5V) by MENU mode.

\*3. Calculating unit (ZX2-CAL) is necessary.

## Calculating Unit

Item	Model	ZX2-CAL
Applicable Amplifier Units		ZX2-LDA11/ZX2-LDA41
Current consumption		12mA max (supplied from the Smart Sensor Amplifier Unit)
Ambient temperature		Operating: 0 to +50°C, storage: -15 to +70°C (with no icing or condensation)
Ambient humidity		Operating and storage: 35 to 85% RH (with no condensation)
Connection method		Connector
Dielectric strength		1,000VAC, 50/60 Hz for 1min.
Insulation resistance		100MΩ min. (at 500VDC)
Vibration resistance (destructive)		10 to 150Hz, 0.7-mm double amplitude, 80min. each in X,Y,and Z directions
Shock resistance (destructive)		300m/s <sup>2</sup> 3 times each in six directions (up/down, left/right, forward/backward)
Materials		Case: PBT (polybutylene terephthalate), Display: Acrylic resin
Weight (packed state)		Approx. 50g
Accessories		Instruction sheet

# Engineering Data (Typical)

## Angle Characteristic

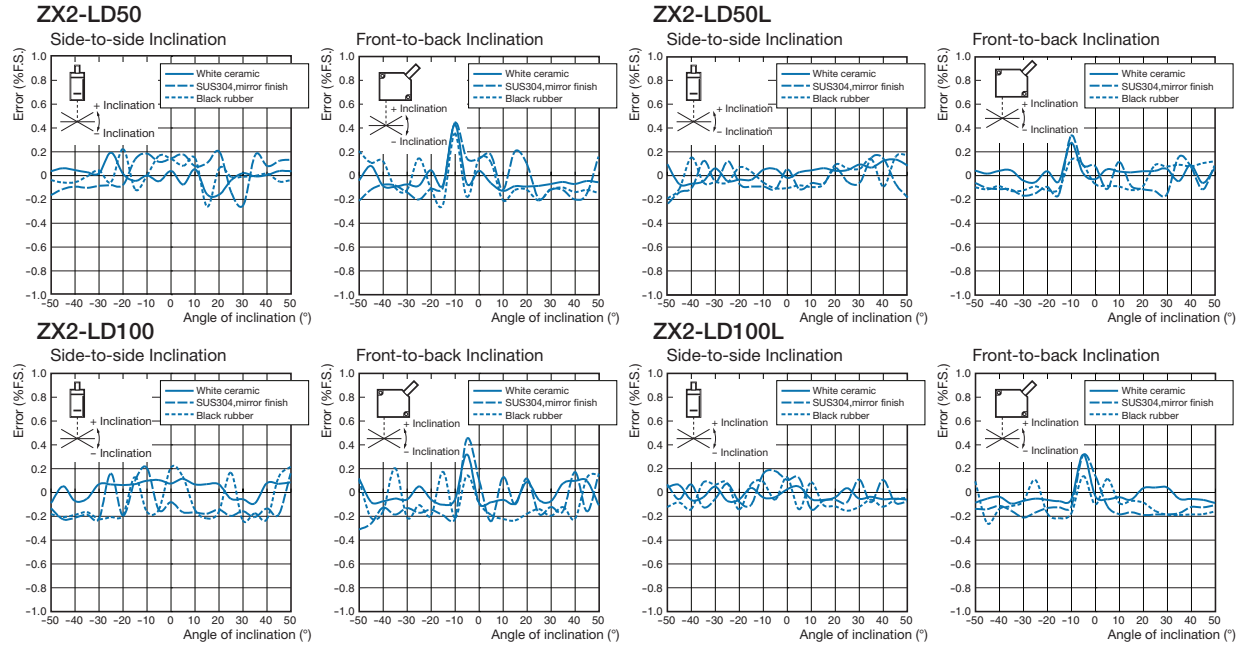

## Linearity Characteristic for Different Materials

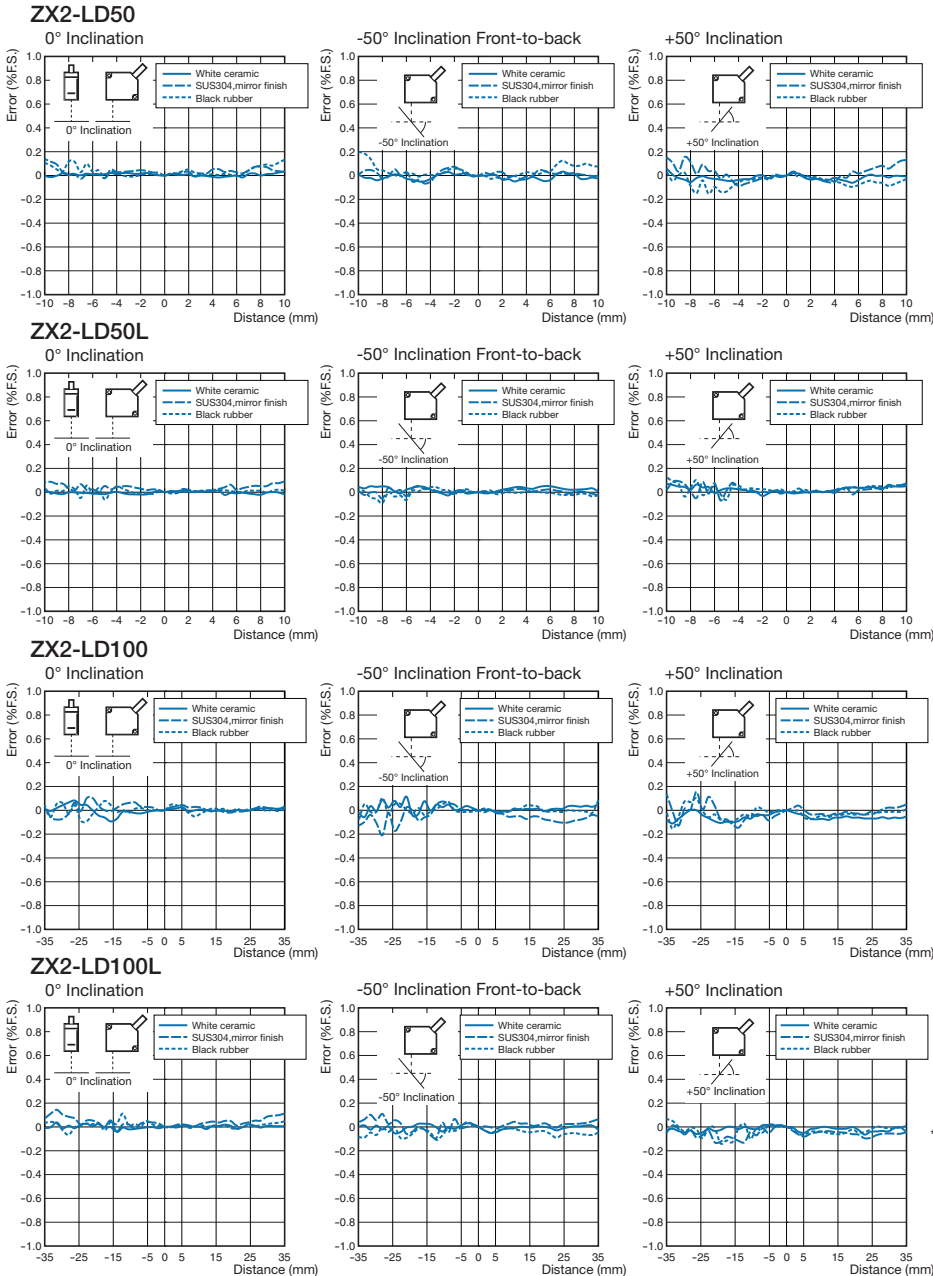

\* The x-axis distance indicates the measurement distance displayed by the amplifier unit. The measurement distance displayed by the amplifier unit takes the measurement center distance as 0 and displays the near-field from the sensor as plus and the far-field as minus.

# Dimensions

(Unit: mm)

## Units

### Sensor Heads

ZX2-LD50/ZX2-LD50L  
ZX2-LD100/ZX2-LD100L



\* In the case of ZX2-LD50 (L), L=50, A=21°  
In the case of ZX2-LD100 (L), L=100, A=11.5°

### Amplifier Units

ZX2-LDA11/ZX2-LDA41

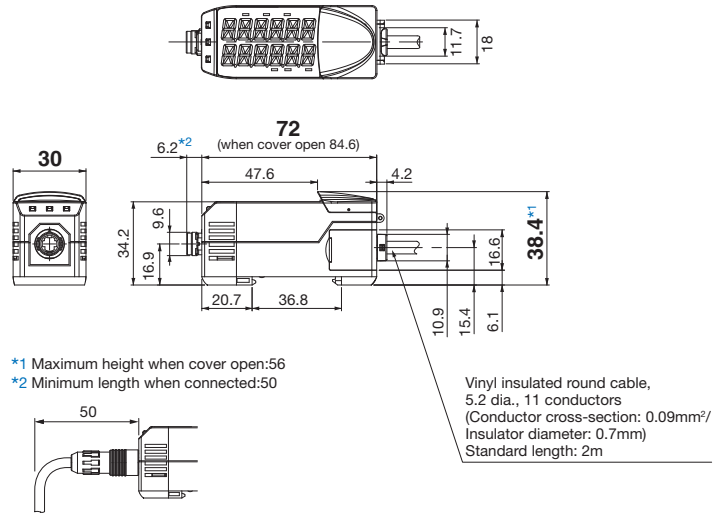

### Calculating Unit

ZX2-CAL

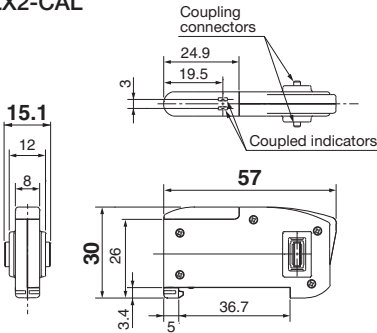

### Sensor Head Extension Cables

ZX2-XC1R  
ZX2-XC4R  
ZX2-XC9R

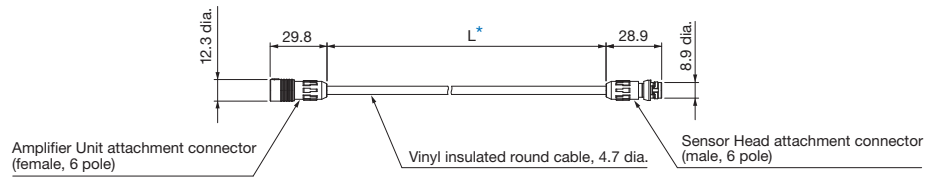

\* Length L is as follows. ZX2-XC1R:1m, ZX2-XC4R:4m, ZX2-XC9R:9m

# Terms and Conditions of Sale

1. **Offer; Acceptance.** These terms and conditions (these "**Terms**") are deemed part of all quotes, agreements, purchase orders, acknowledgments, price lists, catalogs, manuals, brochures and other documents, whether electronic or in writing, relating to the sale of products or services (collectively, the "**Products**") by Omron Electronics LLC and its subsidiary companies ("**Omron**"). Omron objects to any terms or conditions proposed in Buyer's purchase order or other documents which are inconsistent with, or in addition to, these Terms.
2. **Prices; Payment Terms.** All prices stated are current, subject to change without notice by Omron. Omron reserves the right to increase or decrease prices on any unshipped portions of outstanding orders. Payments for Products are due net 30 days unless otherwise stated in the invoice.
3. **Discounts.** Cash discounts, if any, will apply only on the net amount of invoices sent to Buyer after deducting transportation charges, taxes and duties, and will be allowed only if (i) the invoice is paid according to Omron's payment terms and (ii) Buyer has no past due amounts.
4. **Interest.** Omron, at its option, may charge Buyer 1-1/2% interest per month or the maximum legal rate, whichever is less, on any balance not paid within the stated terms.
5. **Orders.** Omron will accept no order less than \$200 net billing.
6. **Governmental Approvals.** Buyer shall be responsible for, and shall bear all costs involved in, obtaining any government approvals required for the importation or sale of the Products.
7. **Taxes.** All taxes, duties and other governmental charges (other than general real property and income taxes), including any interest or penalties thereon, imposed directly or indirectly on Omron or required to be collected directly or indirectly by Omron for the manufacture, production, sale, delivery, importation, consumption or use of the Products sold hereunder (including customs duties and sales, excise, use, turnover and license taxes) shall be charged to and remitted by Buyer to Omron.
8. **Financial.** If the financial position of Buyer at any time becomes unsatisfactory to Omron, Omron reserves the right to stop shipments or require satisfactory security or payment in advance. If Buyer fails to make payment or otherwise comply with these Terms or any related agreement, Omron may (without liability and in addition to other remedies) cancel any unshipped portion of Products sold hereunder and stop any Products in transit until Buyer pays all amounts, including amounts payable hereunder, whether or not then due, which are owing to it by Buyer. Buyer shall in any event remain liable for all unpaid accounts.
9. **Cancellation; Etc.** Orders are not subject to rescheduling or cancellation unless Buyer indemnifies Omron against all related costs or expenses.
10. **Force Majeure.** Omron shall not be liable for any delay or failure in delivery resulting from causes beyond its control, including earthquakes, fires, floods, strikes or other labor disputes, shortage of labor or materials, accidents to machinery, acts of sabotage, riots, delay in or lack of transportation or the requirements of any government authority.
11. **Shipping; Delivery.** Unless otherwise expressly agreed in writing by Omron:
  - a. Shipments shall be by a carrier selected by Omron; Omron will not drop ship except in "break down" situations.
  - b. Such carrier shall act as the agent of Buyer and delivery to such carrier shall constitute delivery to Buyer;
  - c. All sales and shipments of Products shall be FOB shipping point (unless otherwise stated in writing by Omron), at which point title and risk of loss shall pass from Omron to Buyer; provided that Omron shall retain a security interest in the Products until the full purchase price is paid;
  - d. Delivery and shipping dates are estimates only; and
  - e. Omron will package Products as it deems proper for protection against normal handling and extra charges apply to special conditions.
12. **Claims.** Any claim by Buyer against Omron for shortage or damage to the Products occurring before delivery to the carrier must be presented in writing to Omron within 30 days of receipt of shipment and include the original transportation bill signed by the carrier noting that the carrier received the Products from Omron in the condition claimed.
13. **Warranties.** (a) **Exclusive Warranty.** Omron's exclusive warranty is that the Products will be free from defects in materials and workmanship for a period of twelve months from the date of sale by Omron (or such other period expressed in writing by Omron). Omron disclaims all other warranties, express or implied. (b) **Limitations.** OMRON MAKES NO WARRANTY OR REPRESENTATION, EXPRESS OR IMPLIED, ABOUT NON-INFRINGEMENT, MERCHANTABILITY OR FITNESS FOR A PARTICULAR PURPOSE OF THE PRODUCTS. BUYER ACKNOWLEDGES THAT IT ALONE HAS DETERMINED THAT THE PRODUCTS WILL SUITABLY MEET THE REQUIREMENTS OF THEIR INTENDED USE. Omron further disclaims all warranties and responsibility of any type for claims or expenses based on infringement by the Products or otherwise of any intellectual property right. (c) **Buyer Remedy.** Omron's sole obligation hereunder shall be, at Omron's election, to (i) replace (in the form originally shipped with Buyer responsible for labor charges for removal or replacement thereof) the non-complying Product, (ii) repair the non-complying Product, or (iii) repay or credit Buyer an amount equal to the purchase price of the non-complying Product; provided that in no event shall Omron be responsible for warranty, repair, indemnity or any other claims or expenses regarding the Products unless Omron's analysis confirms that the Products were properly handled, stored, installed and maintained and not subject to contamination, abuse, misuse or inappropriate modification. Return of any Products by Buyer must be approved in writing by Omron before shipment. Omron Companies shall not be liable for the suitability or unsuitability or the results from the use of Products in combination with any electrical or electronic components, circuits, system assemblies or any other materials or substances or environments. Any advice, recommendations or information given orally or in writing, are not to be construed as an amendment or addition to the above warranty. See <http://www.omron247.com> or contact your Omron representative for published information.
14. **Limitation on Liability; Etc.** OMRON COMPANIES SHALL NOT BE LIABLE FOR SPECIAL, INDIRECT, INCIDENTAL, OR CONSEQUENTIAL DAMAGES, LOSS OF PROFITS OR PRODUCTION OR COMMERCIAL LOSS IN ANY WAY CONNECTED WITH THE PRODUCTS, WHETHER SUCH CLAIM IS BASED IN CONTRACT, WARRANTY, NEGLIGENCE OR STRICT LIABILITY. Further, in no event shall liability of Omron Companies exceed the individual price of the Product on which liability is asserted.
15. **Indemnities.** Buyer shall indemnify and hold harmless Omron Companies and their employees from and against all liabilities, losses, claims, costs and expenses (including attorney's fees and expenses) related to any claim, investigation, litigation or proceeding (whether or not Omron is a party) which arises or is alleged to arise from Buyer's acts or omissions under these Terms or in any way with respect to the Products. Without limiting the foregoing, Buyer (at its own expense) shall indemnify and hold harmless Omron and defend or settle any action brought against such Companies to the extent based on a claim that any Product made to Buyer specifications infringed intellectual property rights of another party.
16. **Property; Confidentiality.** Any intellectual property in the Products is the exclusive property of Omron Companies and Buyer shall not attempt to duplicate it in any way without the written permission of Omron. Notwithstanding any charges to Buyer for engineering or tooling, all engineering and tooling shall remain the exclusive property of Omron. All information and materials supplied by Omron to Buyer relating to the Products are confidential and proprietary, and Buyer shall limit distribution thereof to its trusted employees and strictly prevent disclosure to any third party.
17. **Export Controls.** Buyer shall comply with all applicable laws, regulations and licenses regarding (i) export of products or information; (ii) sale of products to "forbidden" or other proscribed persons; and (iii) disclosure to non-citizens of regulated technology or information.
18. **Miscellaneous.** (a) **Waiver.** No failure or delay by Omron in exercising any right and no course of dealing between Buyer and Omron shall operate as a waiver of rights by Omron. (b) **Assignment.** Buyer may not assign its rights hereunder without Omron's written consent. (c) **Law.** These Terms are governed by the law of the jurisdiction of the home office of the Omron company from which Buyer is purchasing the Products (without regard to conflict of law principles). (d) **Amendment.** These Terms constitute the entire agreement between Buyer and Omron relating to the Products, and no provision may be changed or waived unless in writing signed by the parties. (e) **Severability.** If any provision hereof is rendered ineffective or invalid, such provision shall not invalidate any other provision. (f) **Setoff.** Buyer shall have no right to set off any amounts against the amount owing in respect of this invoice. (g) **Definitions.** As used herein, "including" means "including without limitation"; and "Omron Companies" (or similar words) mean Omron Corporation and any direct or indirect subsidiary or affiliate thereof.

## Certain Precautions on Specifications and Use

1. **Suitability of Use.** Omron Companies shall not be responsible for conformity with any standards, codes or regulations which apply to the combination of the Product in the Buyer's application or use of the Product. At Buyer's request, Omron will provide applicable third party certification documents identifying ratings and limitations of use which apply to the Product. This information by itself is not sufficient for a complete determination of the suitability of the Product in combination with the end product, machine, system, or other application or use. Buyer shall be solely responsible for determining appropriateness of the particular Product with respect to Buyer's application, product or system. Buyer shall take application responsibility in all cases but the following is a non-exhaustive list of applications for which particular attention must be given:
  - (i) Outdoor use, uses involving potential chemical contamination or electrical interference, or conditions or uses not described in this document.
  - (ii) Use in consumer products or any use in significant quantities.
  - (iii) Energy control systems, combustion systems, railroad systems, aviation systems, medical equipment, amusement machines, vehicles, safety equipment, and installations subject to separate industry or government regulations.
  - (iv) Systems, machines and equipment that could present a risk to life or property. Please know and observe all prohibitions of use applicable to this Product.

NEVER USE THE PRODUCT FOR AN APPLICATION INVOLVING SERIOUS RISK TO LIFE OR PROPERTY OR IN LARGE QUANTITIES WITHOUT ENSURING THAT THE SYSTEM AS A WHOLE HAS BEEN DESIGNED TO ADDRESS THE RISKS, AND THAT THE OMRON'S PRODUCT IS PROPERLY RATED AND INSTALLED FOR THE INTENDED USE WITHIN THE OVERALL EQUIPMENT OR SYSTEM.
2. **Programmable Products.** Omron Companies shall not be responsible for the user's programming of a programmable Product, or any consequence thereof.
3. **Performance Data.** Data presented in Omron Company websites, catalogs and other materials is provided as a guide for the user in determining suitability and does not constitute a warranty. It may represent the result of Omron's test conditions, and the user must correlate it to actual application requirements. Actual performance is subject to the Omron's Warranty and Limitations of Liability.
4. **Change in Specifications.** Product specifications and accessories may be changed at any time based on improvements and other reasons. It is our practice to change part numbers when published ratings or features are changed, or when significant construction changes are made. However, some specifications of the Product may be changed without any notice. When in doubt, special part numbers may be assigned to fix or establish key specifications for your application. Please consult with your Omron's representative at any time to confirm actual specifications of purchased Product.
5. **Errors and Omissions.** Information presented by Omron Companies has been checked and is believed to be accurate; however, no responsibility is assumed for clerical, typographical or proofreading errors or omissions.

**OMRON INDUSTRIAL AUTOMATION • THE AMERICAS HEADQUARTERS** • Schaumburg, IL USA • 847.843.7900 • 800.556.6766 • [www.omron247.com](http://www.omron247.com)

**OMRON CANADA, INC. • HEAD OFFICE**

Toronto, ON, Canada • 416.286.6465 • 866.986.6766 • [www.omron247.com](http://www.omron247.com)

**OMRON ELECTRONICS DE MEXICO • HEAD OFFICE**

México DF • 52.55.59.01.43.00 • 001.800.556.6766 • [mela@omron.com](mailto:mela@omron.com)

**OMRON ELECTRONICS DE MEXICO • SALES OFFICE**

Apodaca, N.L. • 52.81.11.56.99.20 • 001.800.556.6766 • [mela@omron.com](mailto:mela@omron.com)

**OMRON ELETRÔNICA DO BRASIL LTDA • HEAD OFFICE**

São Paulo, SP, Brasil • 55.11.2101.6300 • [www.omron.com.br](http://www.omron.com.br)

**OMRON ARGENTINA • SALES OFFICE**

Cono Sur • 54.11.4783.5300

**OMRON CHILE • SALES OFFICE**

Santiago • 56.9.9917.3920

**OTHER OMRON LATIN AMERICA SALES**

54.11.4783.5300

**OMRON EUROPE B.V.** • Wegalaan 67-69, NL-2132 JD, Hoofddorp, The Netherlands. • Tel: +31 (0) 23 568 13 00 • Fax: +31 (0) 23 568 13 88 • [www.industrial.omron.eu](http://www.industrial.omron.eu)

*Authorized Distributor:*

**Automation Systems**

- Programmable logic controllers (PLC) • Human machine interfaces (HMI) • Remote I/O
- Industrial PC's • Software

**Motion & Drives**

- Motion controllers • Servo systems • AC drives

**Control Components**

- Temperature controllers • Power supplies • Timers • Counters • Programmable relays
- Digital panel indicators • Electromechanical relays • Monitoring products • Solid-state relays
- Limit switches • Pushbutton switches • Low voltage switch gear

**Sensing & Safety**

- Photoelectric sensors • Inductive sensors • Capacitive & pressure sensors
- Cable connectors • Displacement & width-measuring sensors • Vision systems
- Safety networks • Safety sensors • Safety units/relay units • Safety door/guard lock switches

Компания «Океан Электроники» предлагает заключение долгосрочных отношений при поставках импортных электронных компонентов на взаимовыгодных условиях!

Наши преимущества:

- Поставка оригинальных импортных электронных компонентов напрямую с производств Америки, Европы и Азии, а так же с крупнейших складов мира;
- Широкая линейка поставок активных и пассивных импортных электронных компонентов (более 30 млн. наименований);
- Поставка сложных, дефицитных, либо снятых с производства позиций;
- Оперативные сроки поставки под заказ (от 5 рабочих дней);
- Экспресс доставка в любую точку России;
- Помощь Конструкторского Отдела и консультации квалифицированных инженеров;
- Техническая поддержка проекта, помощь в подборе аналогов, поставка прототипов;
- Поставка электронных компонентов под контролем ВП;
- Система менеджмента качества сертифицирована по Международному стандарту ISO 9001;
- При необходимости вся продукция военного и аэрокосмического назначения проходит испытания и сертификацию в лаборатории (по согласованию с заказчиком);
- Поставка специализированных компонентов военного и аэрокосмического уровня качества (Xilinx, Altera, Analog Devices, Intersil, Interpoint, Microsemi, Actel, Aeroflex, Peregrine, VPT, Syfer, Eurofarad, Texas Instruments, MS Kennedy, Miteq, Cobham, E2V, MA-COM, Hittite, Mini-Circuits, General Dynamics и др.);

Компания «Океан Электроники» является официальным дистрибьютором и эксклюзивным представителем в России одного из крупнейших производителей разъемов военного и аэрокосмического назначения «JONHON», а так же официальным дистрибьютором и эксклюзивным представителем в России производителя высокотехнологичных и надежных решений для передачи СВЧ сигналов «FORSTAR».



## JONHON

«JONHON» (основан в 1970 г.)

Разъемы специального, военного и аэрокосмического назначения:

(Применяются в военной, авиационной, аэрокосмической, морской, железнодорожной, горно- и нефтедобывающей отраслях промышленности)

«FORSTAR» (основан в 1998 г.)

ВЧ соединители, коаксиальные кабели, кабельные сборки и микроволновые компоненты:

(Применяются в телекоммуникациях гражданского и специального назначения, в средствах связи, РЛС, а так же военной, авиационной и аэрокосмической отраслях промышленности).



Телефон: 8 (812) 309-75-97 (многоканальный)

Факс: 8 (812) 320-03-32

Электронная почта: [ocean@oceanchips.ru](mailto:ocean@oceanchips.ru)

Web: <http://oceanchips.ru/>

Адрес: 198099, г. Санкт-Петербург, ул. Калинина, д. 2, корп. 4, лит. А