

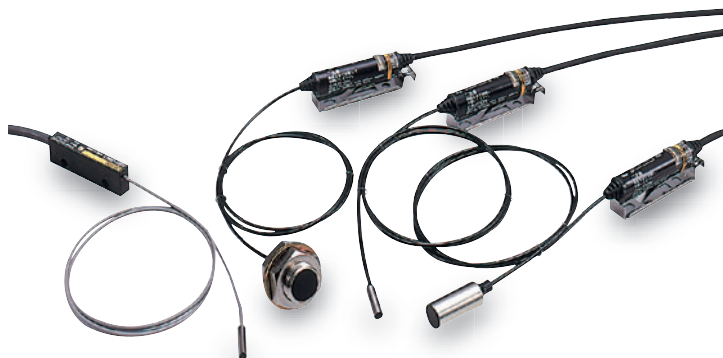

Subminiature Sensors with Long-distance Detection

- Shielded Sensor Heads from 3-mm to M12 diameters that can be embedded in metal.
- Robotics cables provided as a standard feature (DC 2-Wire Models).
- Indicator provided in Amplifier cable for easy confirmation of operation.
- Power supply range of 5 to 24 VDC for DC 3-Wire Models.



 Be sure to read *Safety Precautions* on page 6.

Ordering Information

Sensors [Refer to *Dimensions* on page 7.]

DC 2-Wire Models

Appearance	Sensing distance	Model		
		Operation mode		
		NO	NC	
	3 dia.	0.8 mm	E2EC-CR8D1 2M *	E2EC-CR8D2 2M *
	5.4 dia.	1.5 mm	E2EC-C1R5D1 2M *	E2EC-C1R5D2 2M *
	8 dia.	3 mm	E2EC-C3D1 2M *	E2EC-C3D2 2M *
	M12	4 mm	E2EC-X4D1 2M *	E2EC-X4D2 2M *

* Models with different frequencies are also available. The model numbers are E2EC-□□□□5 (example: E2EC-CR8D15).

DC 3-Wire Models

Appearance	Sensing distance	Model	
		Output configuration	NO
	3 dia.	NPN open-collector output	E2EC-CR5C1 2M *
	8 dia.		E2EC-C2R5C1 2M *

* Models with different frequencies are also available. The model numbers are E2EC-□□□□5 (example: E2EC-CR5D15).

Accessories (Order Separately)

Mounting Bracket

The Mounting Bracket for the E2EC-C1R5D□ is not provided with the Sensor. Order a Mounting Bracket separately if required. [Refer to *Dimensions* on page 8.]

Appearance	Model	Applicable Sensors
	Y92E-F5R4	E2EC-C1R5D□ (5.4-mm-dia. Sensor)

Ratings and Specifications

Item	Model	DC 2-Wire Models				DC 3-Wire Models	
		E2EC-CR8D□	E2EC-C1R5D□	E2EC-C3D□	E2EC-X4D□	E2EC-CR5C1	E2EC-C2R5C1
Sensing distance		0.8 mm ±15%	1.5 mm ±10%	3 mm ±10%	4 mm ±10%	0.5 mm ±15%	2.5 mm ±10%
Set distance		0 to 0.56 mm	0 to 1.05 mm	0 to 2.1 mm	0 to 2.8 mm	0 to 0.3 mm	0 to 1.7 mm
Differential travel		10% max. of sensing distance					
Detectable object		Ferrous metal (The sensing distance decreases with non-ferrous metal. Refer to <i>Engineering Data</i> on page 3.)					
Standard sensing object		Iron, 5 × 5 × 1 mm		Iron, 8 × 8 × 1 mm	Iron, 12 × 12 × 1 mm	Iron, 5 × 5 × 1 mm	Iron, 8 × 8 × 1 mm
Response frequency ^{*1}		1.5 kHz		1 kHz			
Power supply voltage (operating voltage range)		12 to 24 VDC (10 to 30 VDC), ripple (p-p): 10% max.				5 to 24 VDC (4.75 to 30 VDC), ripple (p-p): 10% max.	
Current consumption		---				10 mA max.	
Leakage current		0.8 mA max.				---	
Control output	Load current	5 to 100 mA				NPN open-collector output, 100 mA max. (30 VDC max.)	
	Residual voltage	3 V max. (Load current: 100 mA, Cable length: 2 m)				1 V max. (Load current: 100 mA, Cable length: 2 m)	
Indicators		D1 Models: Operation indicator (red), Setting indicator (green) D2 Models: Operation indicator (red)				Detection indicator (red)	
Operation mode (with sensing object approaching)		D1 Models: NO D2 Models: NC Refer to the timing charts under <i>I/O Circuit Diagrams</i> on page 5 for details.				NO Refer to the timing charts under <i>I/O Circuit Diagrams</i> on page 5 for details.	
Protection circuits		Load short-circuit protection, Surge suppressor				Surge suppressor	
Ambient temperature range		Operating/Storage: -25 to 70°C (with no icing or condensation) ^{*2}					
Ambient humidity range		Operating/Storage: 35% to 95% (with no condensation)					
Temperature influence		±20% max. of sensing distance at 23°C in the temperature range of -25 to 70°C					
Voltage influence		±2.5% max. of sensing distance at rated voltage in the rated voltage ±15% range				±5% max. of sensing distance at the rated voltage range in the voltage range of 4.75 to 30 V	
Insulation resistance		50 MΩ min. (at 500 VDC) between current-carrying parts and case					
Dielectric strength		1,000 VAC for 1 min between current-carrying parts and case				500 VAC for 1 min between current-carrying parts and case	
Vibration resistance		Destruction: 10 to 55 Hz, 1.5-mm double amplitude for 2 hours each in X, Y, and Z directions					
Shock resistance		Destruction: 1,000 m/s ² 10 times each in X, Y, and Z directions				Destruction: 500 m/s ² 10 times each in X, Y, and Z directions	
Degree of protection		IEC 60529 IP67, In-house standards: oil-resistant (For Sensor Head only)				IEC 60529 IP64	
Connection method		Pre-wired Models (Standard cable length: 2 m)					
Weight (packed state)		Approx. 45 g					
Materials	Case	Brass					
	Sensing surface	ABS					
	Clamp-ing nut	---		Brass (nickel-plated)		---	
	Toothed washer	---		Iron (zinc-plated)		---	
Accessories		Amplifier Mounting Bracket, Instruction manual				Instruction manual	

*1. The response frequency is an average value.

Measurement conditions are as follows: standard sensing object, a distance of twice the standard sensing object, and a set distance of half the sensing distance.

*2. Incorrect operation may occur if there is a large temperature difference between the Sensor Head and the Amplifier Unit.

Engineering Data (Typical)

Sensing Area

E2EC-CR8D1

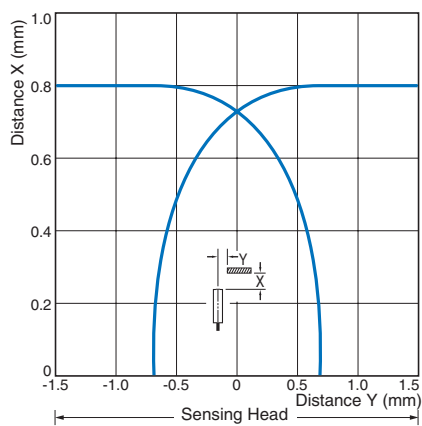

E2EC-C1R5D1

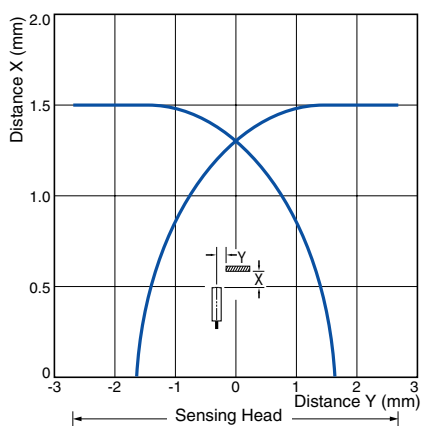

E2EC-C3D1

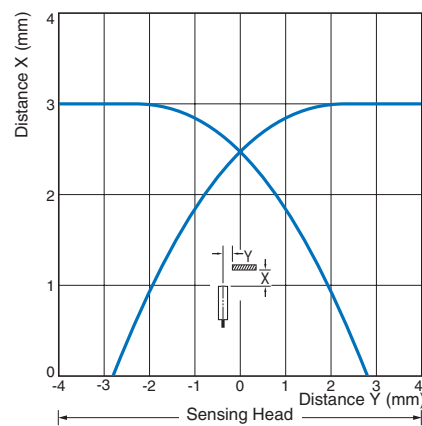

E2EC-X4D1

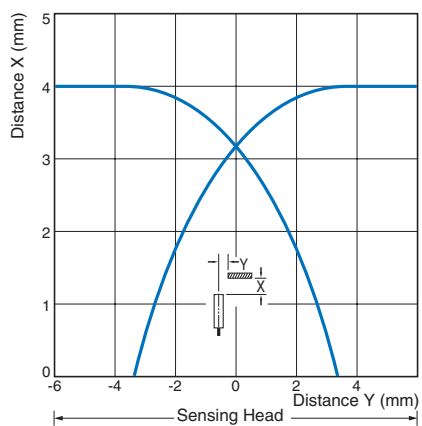

E2EC-CR5C1

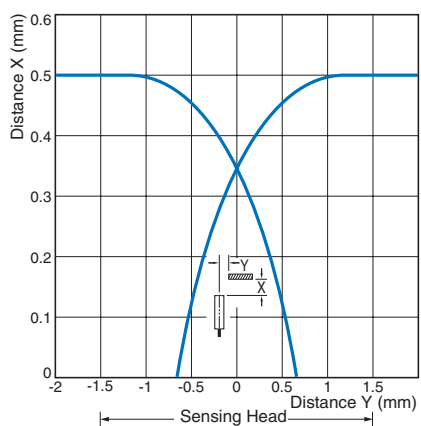

E2EC-C2R5C1

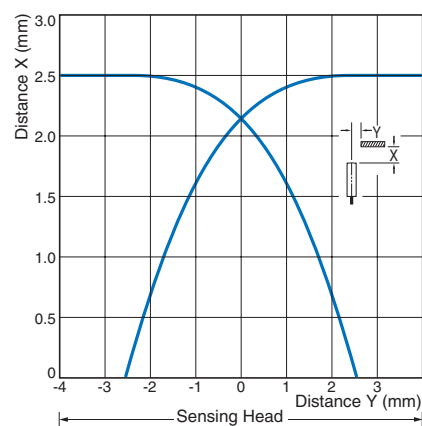

Influence of Sensing Object Size and Material

E2EC-CR8D1

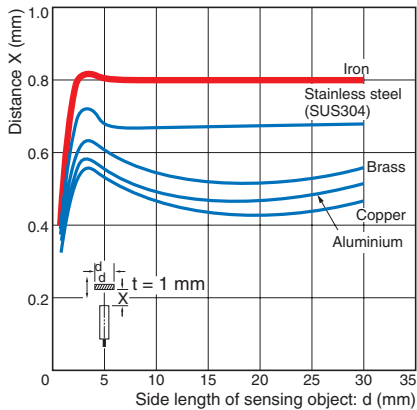

E2EC-C1R5D1

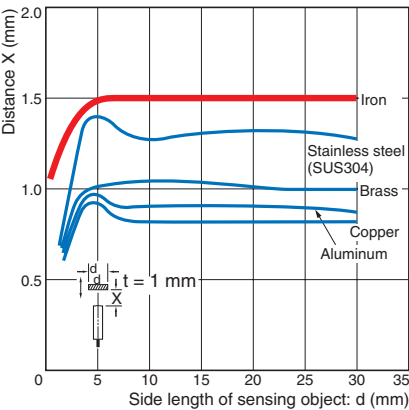

E2EC-C3D1

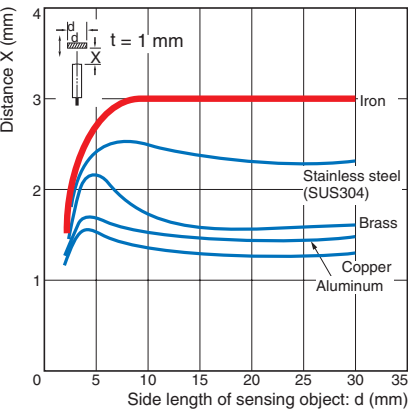

E2EC-X4D1

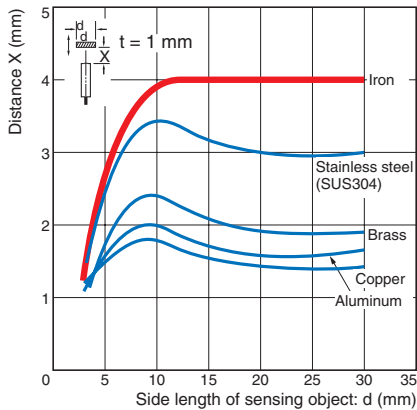

E2EC-CR5C1

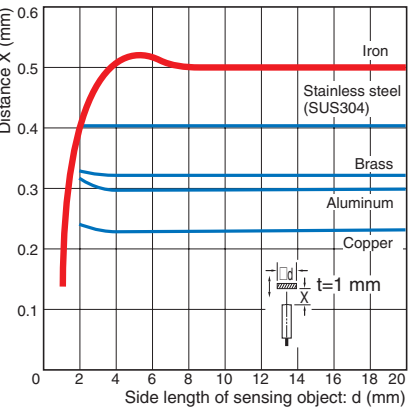

E2EC-C2R5C1

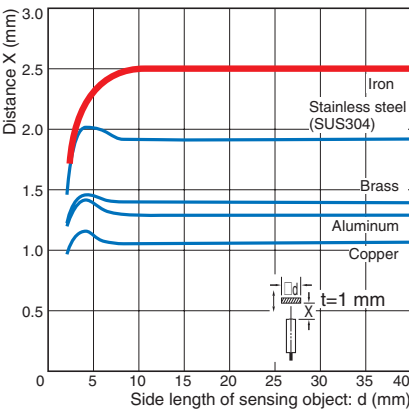

Residual Output Voltage

DC 2-Wire Models

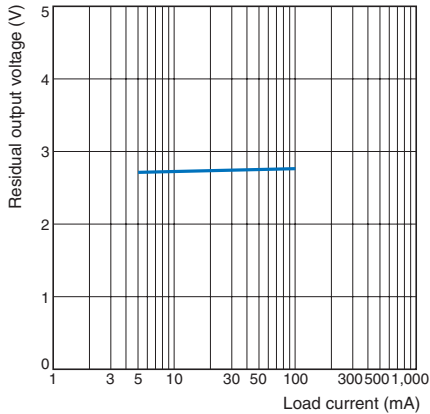

Leakage Current

E2EC

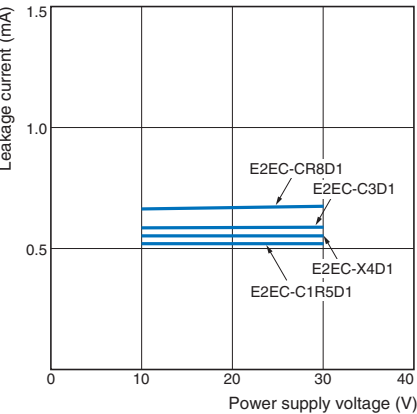

I/O Circuit Diagrams

DC 2-Wire Models

Operation	Model	Timing Chart	Output circuit
NO	E2EC-CR8D1 E2EC-C1R5D1 E2EC-C3D1 E2EC-X4D1		<p>Note: The load can be connected to either the +V or 0 V side.</p>
NC	E2EC-CR8D2 E2EC-C1R5D2 E2EC-C3D2 E2EC-X4D2		

DC 3-Wire Models

Operation	Model	Timing Chart	Output circuit
NO	E2EC-CR5C1 E2EC-C2R5C1		<p>Maximum load current: 100 mA</p> <p>Note: The Sensor may be destroyed if mistakes are made in wiring.</p>

Safety Precautions

Refer to *Warranty and Limitations of Liability*.

⚠ WARNING

This product is not designed or rated for ensuring safety of persons either directly or indirectly. Do not use it for such purposes.

Precautions for Correct Use

Do not use this product under ambient conditions that exceed the ratings.

● **Design**

Influence of Surrounding Metal

When mounting the Sensor within a metal panel, ensure that the clearances given in the following table are maintained. Failure to maintain these distances may cause deterioration in the performance of the Sensor.

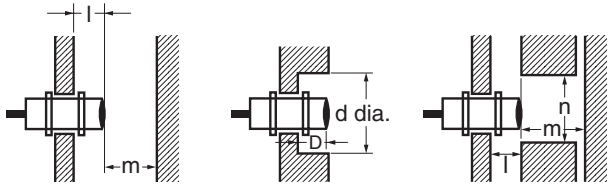

Influence of Surrounding Metal (Unit: mm)

Model	Item	l	d	D	m	n
E2EC-CR8D□	0	3	0	0	2.4	6
E2EC-C1R5D□		5.4			4.5	10.8
E2EC-C3D□		8			9	16
E2EC-X4D□		12			12	24
E2EC-CR5C1		3			1.5	5
E2EC-C2R5C1		8			10	21

Influence of Temperature

Incorrect operation may occur if there is a large temperature difference between the Sensor Head and the Amplifier Unit.

Amplifier Mounting Bracket for DC 2-Wire Models
Mounting

1. Insert the Amplifier into the trapezoidal end (i.e., the fixing side) of the Mounting Bracket.



2. Press the other end of the Amplifier onto the Bracket.

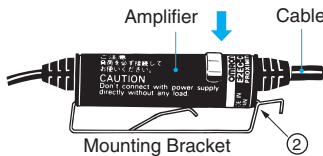

Mutual Interference

When installing Sensors face-to-face or side-by-side, ensure that the minimum distances given in the following table are maintained.



Mutual Interference (Unit: mm)

Model	Item	A	B
E2EC-CR8D□		18 (4)	6 (3)
E2EC-C1R5D□		15 (8)	10.8 (5.4)
E2EC-C3D□		30 (15)	16 (8)
E2EC-X4D□		40 (20)	24 (12)
E2EC-CR5C1		20 (10)	15 (3)
E2EC-C2R5C1		40 (20)	25 (15)

Note: Values in parentheses apply to Sensors operating at different frequencies.

● **Mounting**

- Refer to the following table for the torque and tightening ranges applied to mount the E2EC-C Unthreaded Cylindrical Model. Tightening must be as given in the following table.

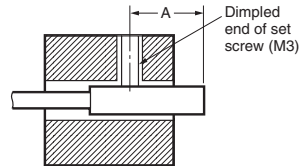

Permissible Tightening Range and Torque

Model	Tightening	Set screw tightening
E2EC-CR8D□	6 to 10 mm	0.49 N·m
E2EC-C1R5D□	8 to 16 mm	
E2EC-C3D□		0.98 N·m
E2EC-CR5C1	6 to 10 mm	0.39 N·m
E2EC-C2R5C1	8 to 16 mm	

- The tightening torque applied to the E2EC-X4D□ Threaded Cylindrical Models must be 12 N·m max.



Dismounting

1. Lightly press the hook on the Mounting Bracket with a flat-blade screwdriver.

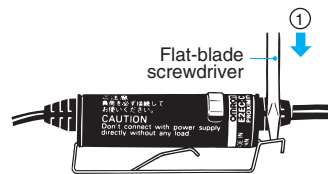

2. The Amplifier will be automatically released due to the spring force of the Mounting Bracket.



Dimensions

Tolerance class IT16 applies to dimensions in this data sheet unless otherwise specified.

Main Units

E2EC-CR8D□

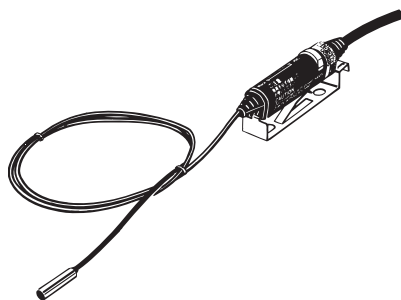

With Mounting Bracket Attached

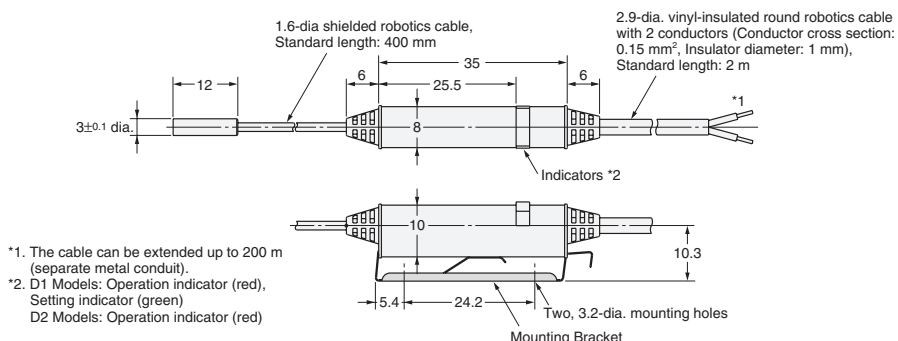

E2EC-C1R5D□

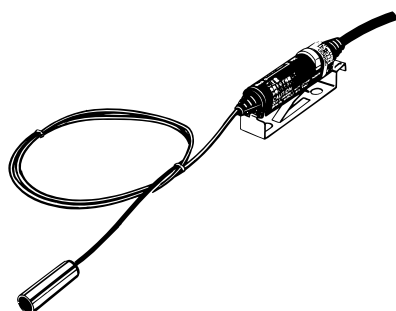

With Mounting Bracket Attached

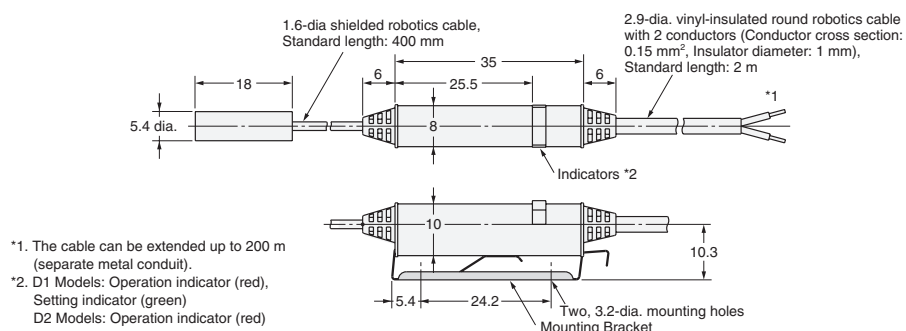

E2EC-C3D□

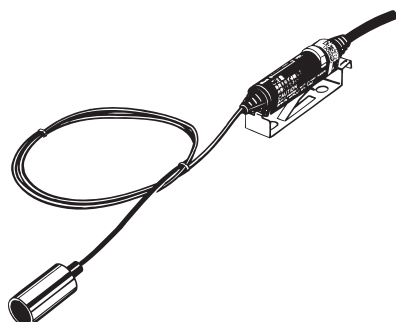

With Mounting Bracket Attached

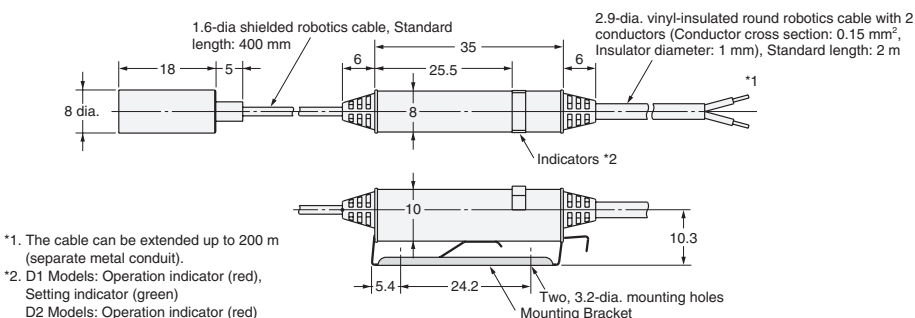

E2EC-X4D□

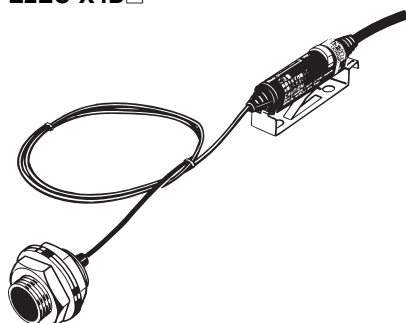

With Mounting Bracket Attached

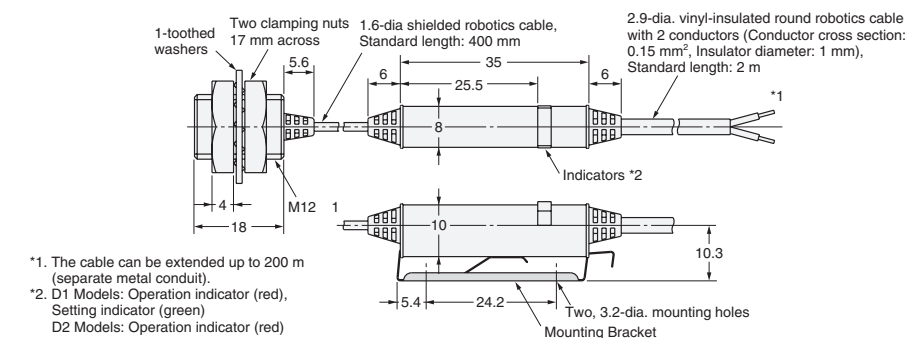

Mounting Hole Dimensions



Model	F (mm)
E2EC-CR8D□	3.3 $^{+0.3}_0$ dia.
E2EC-C1R5D□	5.7 $^{+0.3}_0$ dia.
E2EC-C3D□	8.5 $^{+0.5}_0$ dia.
E2EC-X4D□	12.5 $^{+0.5}_0$ dia.

E2EC-CR5C1

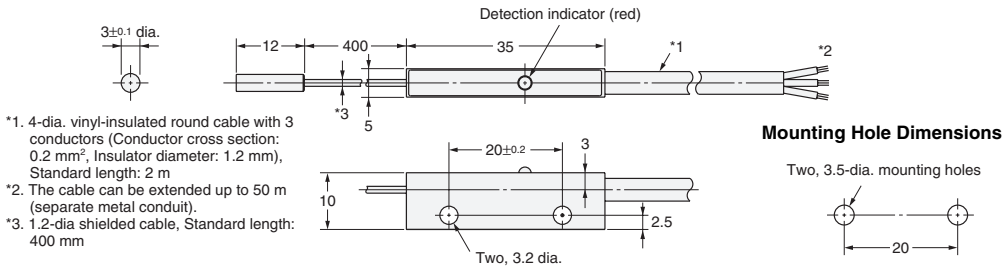
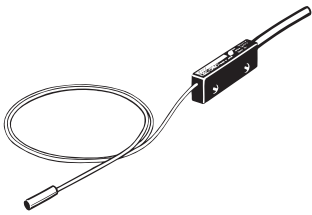

E2EC-C2R5C1

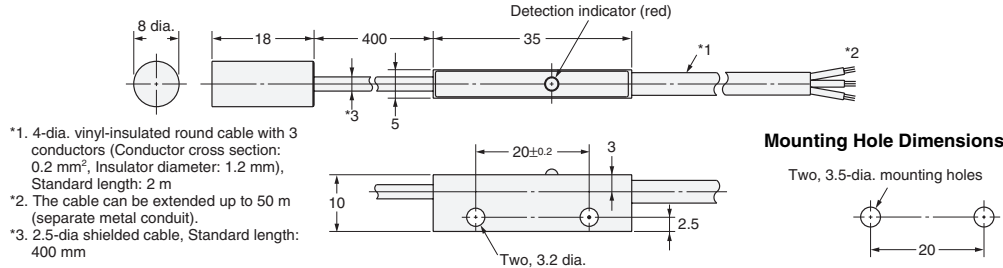
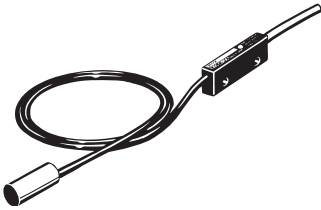

Mounting Hole Dimensions



Model	F (mm)
E2EC-CR5C1	3.3 ^{+0.3} / ₀ dia.
E2EC-C2R5C1	8.5 ^{+0.5} / ₀ dia.

Mounting Bracket

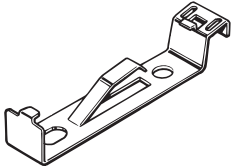

Material: Stainless steel (SUS301)
 Note: Provided with DC 2-Wire Models.

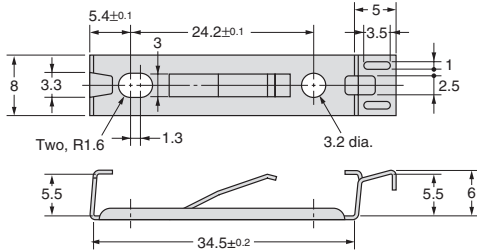

Accessories (Order Separately)

Mounting Bracket (for 5.4 dia.)

Y92E-F5R4



Material: Stainless steel (SUS304)
 Note: Used for E2EC-C1R5D□ Head.

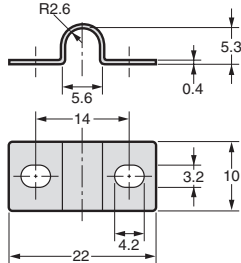

Read and Understand This Catalog

Please read and understand this catalog before purchasing the products. Please consult your OMRON representative if you have any questions or comments.

Warranty and Limitations of Liability

WARRANTY

OMRON's exclusive warranty is that the products are free from defects in materials and workmanship for a period of one year (or other period if specified) from date of sale by OMRON.

OMRON MAKES NO WARRANTY OR REPRESENTATION, EXPRESS OR IMPLIED, REGARDING NON-INFRINGEMENT, MERCHANTABILITY, OR FITNESS FOR PARTICULAR PURPOSE OF THE PRODUCTS. ANY BUYER OR USER ACKNOWLEDGES THAT THE BUYER OR USER ALONE HAS DETERMINED THAT THE PRODUCTS WILL SUITABLY MEET THE REQUIREMENTS OF THEIR INTENDED USE. OMRON DISCLAIMS ALL OTHER WARRANTIES, EXPRESS OR IMPLIED.

LIMITATIONS OF LIABILITY

OMRON SHALL NOT BE RESPONSIBLE FOR SPECIAL, INDIRECT, OR CONSEQUENTIAL DAMAGES, LOSS OF PROFITS OR COMMERCIAL LOSS IN ANY WAY CONNECTED WITH THE PRODUCTS, WHETHER SUCH CLAIM IS BASED ON CONTRACT, WARRANTY, NEGLIGENCE, OR STRICT LIABILITY.

In no event shall the responsibility of OMRON for any act exceed the individual price of the product on which liability is asserted.

IN NO EVENT SHALL OMRON BE RESPONSIBLE FOR WARRANTY, REPAIR, OR OTHER CLAIMS REGARDING THE PRODUCTS UNLESS OMRON'S ANALYSIS CONFIRMS THAT THE PRODUCTS WERE PROPERLY HANDLED, STORED, INSTALLED, AND MAINTAINED AND NOT SUBJECT TO CONTAMINATION, ABUSE, MISUSE, OR INAPPROPRIATE MODIFICATION OR REPAIR.

Application Considerations

SUITABILITY FOR USE

OMRON shall not be responsible for conformity with any standards, codes, or regulations that apply to the combination of products in the customer's application or use of the products.

At the customer's request, OMRON will provide applicable third party certification documents identifying ratings and limitations of use that apply to the products. This information by itself is not sufficient for a complete determination of the suitability of the products in combination with the end product, machine, system, or other application or use.

The following are some examples of applications for which particular attention must be given. This is not intended to be an exhaustive list of all possible uses of the products, nor is it intended to imply that the uses listed may be suitable for the products:

- Outdoor use, uses involving potential chemical contamination or electrical interference, or conditions or uses not described in this catalog.
- Nuclear energy control systems, combustion systems, railroad systems, aviation systems, medical equipment, amusement machines, vehicles, safety equipment, and installations subject to separate industry or government regulations.
- Systems, machines, and equipment that could present a risk to life or property.

Please know and observe all prohibitions of use applicable to the products.

NEVER USE THE PRODUCTS FOR AN APPLICATION INVOLVING SERIOUS RISK TO LIFE OR PROPERTY WITHOUT ENSURING THAT THE SYSTEM AS A WHOLE HAS BEEN DESIGNED TO ADDRESS THE RISKS, AND THAT THE OMRON PRODUCTS ARE PROPERLY RATED AND INSTALLED FOR THE INTENDED USE WITHIN THE OVERALL EQUIPMENT OR SYSTEM.

PROGRAMMABLE PRODUCTS

OMRON shall not be responsible for the user's programming of a programmable product, or any consequence thereof.

Disclaimers

CHANGE IN SPECIFICATIONS

Product specifications and accessories may be changed at any time based on improvements and other reasons.

It is our practice to change model numbers when published ratings or features are changed, or when significant construction changes are made. However, some specifications of the products may be changed without any notice. When in doubt, special model numbers may be assigned to fix or establish key specifications for your application on your request. Please consult with your OMRON representative at any time to confirm actual specifications of purchased products.

DIMENSIONS AND WEIGHTS

Dimensions and weights are nominal and are not to be used for manufacturing purposes, even when tolerances are shown.

PERFORMANCE DATA

Performance data given in this catalog is provided as a guide for the user in determining suitability and does not constitute a warranty. It may represent the result of OMRON's test conditions, and the users must correlate it to actual application requirements. Actual performance is subject to the OMRON Warranty and Limitations of Liability.

ERRORS AND OMISSIONS

The information in this document has been carefully checked and is believed to be accurate; however, no responsibility is assumed for clerical, typographical, or proofreading errors, or omissions.

2011.10

In the interest of product improvement, specifications are subject to change without notice.

OMRON Corporation
Industrial Automation Company

<http://www.ia.omron.com/>

(c)Copyright OMRON Corporation 2011 All Right Reserved.

Компания «Океан Электроники» предлагает заключение долгосрочных отношений при поставках импортных электронных компонентов на взаимовыгодных условиях!

Наши преимущества:

- Поставка оригинальных импортных электронных компонентов напрямую с производств Америки, Европы и Азии, а так же с крупнейших складов мира;
- Широкая линейка поставок активных и пассивных импортных электронных компонентов (более 30 млн. наименований);
- Поставка сложных, дефицитных, либо снятых с производства позиций;
- Оперативные сроки поставки под заказ (от 5 рабочих дней);
- Экспресс доставка в любую точку России;
- Помощь Конструкторского Отдела и консультации квалифицированных инженеров;
- Техническая поддержка проекта, помощь в подборе аналогов, поставка прототипов;
- Поставка электронных компонентов под контролем ВП;
- Система менеджмента качества сертифицирована по Международному стандарту ISO 9001;
- При необходимости вся продукция военного и аэрокосмического назначения проходит испытания и сертификацию в лаборатории (по согласованию с заказчиком);
- Поставка специализированных компонентов военного и аэрокосмического уровня качества (Xilinx, Altera, Analog Devices, Intersil, Interpoint, Microsemi, Actel, Aeroflex, Peregrine, VPT, Syfer, Eurofarad, Texas Instruments, MS Kennedy, Miteq, Cobham, E2V, MA-COM, Hittite, Mini-Circuits, General Dynamics и др.);

Компания «Океан Электроники» является официальным дистрибьютором и эксклюзивным представителем в России одного из крупнейших производителей разъемов военного и аэрокосмического назначения «JONHON», а так же официальным дистрибьютором и эксклюзивным представителем в России производителя высокотехнологичных и надежных решений для передачи СВЧ сигналов «FORSTAR».



JONHON

«JONHON» (основан в 1970 г.)

Разъемы специального, военного и аэрокосмического назначения:

(Применяются в военной, авиационной, аэрокосмической, морской, железнодорожной, горно- и нефтедобывающей отраслях промышленности)

«FORSTAR» (основан в 1998 г.)

ВЧ соединители, коаксиальные кабели, кабельные сборки и микроволновые компоненты:

(Применяются в телекоммуникациях гражданского и специального назначения, в средствах связи, РЛС, а так же военной, авиационной и аэрокосмической отраслях промышленности).



Телефон: 8 (812) 309-75-97 (многоканальный)

Факс: 8 (812) 320-03-32

Электронная почта: ocean@oceanchips.ru

Web: <http://oceanchips.ru/>

Адрес: 198099, г. Санкт-Петербург, ул. Калинина, д. 2, корп. 4, лит. А