

# Super-mini package regulator IC

## BA000LBSG series

The BA000LBSG (the "000" indicates the output voltage value) is a low-saturation series regulator IC employing the super-mini mold package of the SMP5 (2916 package). Equipped with a power-saving function that reduces current consumption, it also offers outstanding ripple rejection and characteristics, and is ideal for cellular telephones and other.

### ●Applications

Residential / industrial device power supplies for cellular telephone such as the CDMA and GSM, and for other portable.

### ●Features

- 1) Internal output transistor ( $I_o=150\text{mA}$ )
- 2) Internal temperature protection circuit
- 3) Power-saving function enables designs with low current consumption
- 4) High level of ripple rejection (R.R.=66dB)
- 5) SMP5 super-mini package enables space-saving designs
- 6) Low I / O voltage differential (90mV Typ. at  $I_o=50\text{mA}$ )

### ●Super-mini regulator lineup

Series	Output voltage (V)								
	2.8	2.9	3.0	3.2	3.3	3.6	3.8	4.0	5.0
BA000LBSG	○	○	○	○	○	○	○	○	○

\* "000" indicates the output voltage value. (Example : For 2.8V output, BA028LBSG)

### ●Absolute maximum ratings ( $T_a=25^\circ\text{C}$ )

Parameter	Symbol	Limits	Unit
Applied voltage	Vcc	9	V
Power dissipation	Pd	170*	mW
Operating temperature	Topr	-40~+85	°C
Storage temperature	Tstg	-55~+125	°C

\* Reduced by 1.7mW for each increase in  $T_a$  of 1°C over 25°C

### ●Recommended operating conditions ( $T_a=25^\circ\text{C}$ )

Parameter	Symbol	Limits	Unit
Operating power supply voltage	Vcc (input)	2.5~7.0	V

Regulator IC

●Block diagram

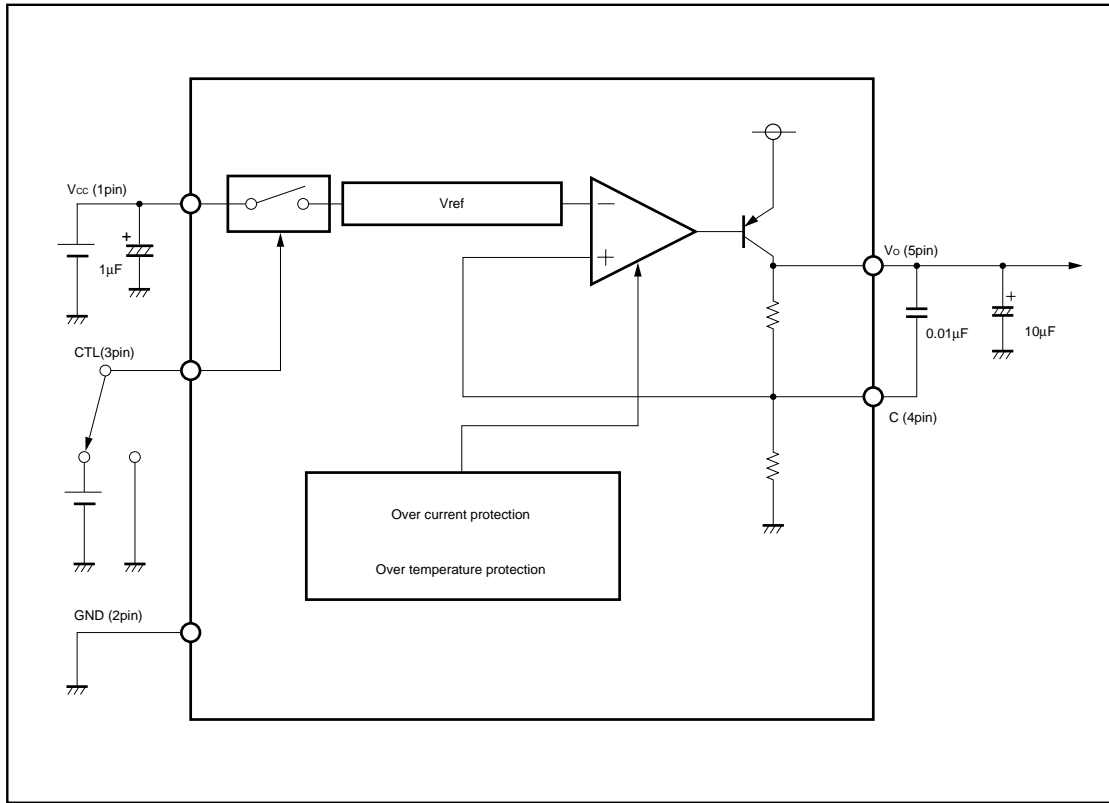

●Pin descriptions

Pin No.	Pin name	Function
1	Vcc	Power supply
2	GND	Ground
3	CTL	Power-save function
4	C	Ripple improvement
5	OUT	Output

●Input / output circuits

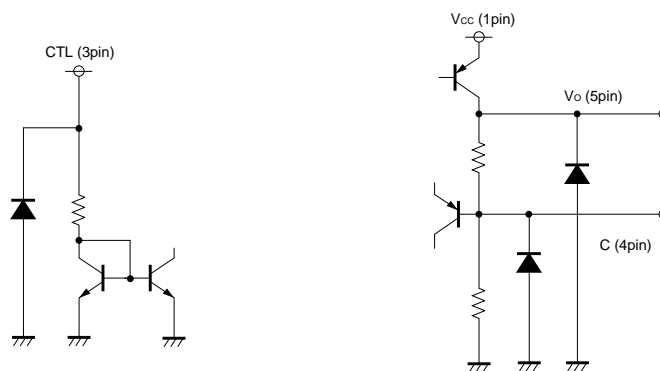

## Regulator IC

## ●Electrical characteristics

BA028LBSG (unless otherwise noted, Ta=25°C, Vcc=3.8V)

Parameter	Symbol	Min.	Typ.	Max.	Unit	Coniditions
Standby current	I <sub>ccs</sub>	-	0	10	μA	V <sub>ctl</sub> =0V
Circuit current	I <sub>cca</sub>	-	65	150	μA	V <sub>ctl</sub> =3V, no output load
<Output block>						
Output voltage	V <sub>o</sub>	2.73	2.80	2.87	V	I <sub>o</sub> =50mA* <sup>1</sup>
Dropout voltage	ΔV <sub>d</sub>	-	90	150	mV	I <sub>o</sub> =50mA, V <sub>cc</sub> =0.95V <sub>o</sub>
Output current capability	I <sub>o</sub>	150	280	-	mA	-
Load regulation	Reg.L	-	40	80	mV	I <sub>o</sub> =1~50mA* <sup>1</sup>
Input regulation	Reg.I	-	3	30	mV	I <sub>o</sub> =10mA, V <sub>cc</sub> =3.8~7V* <sup>1</sup>
Output noise voltage	e <sub>n</sub>	-	56	-	μV	I <sub>o</sub> =10mA, C=0.01μF* <sup>2</sup>
Ripple rejection 1	R.R1	50	58	-	dB	I <sub>o</sub> =10mA, f=400Hz
Ripple rejection 2	R.R2	-	66	-	dB	I <sub>o</sub> =10mA, f=400Hz, C=0.01μF* <sup>2</sup>
<Power-save block>						
CTL OFF voltage	V <sub>off</sub>	-	-	0.6	V	-
CTL ON voltage	V <sub>on</sub>	2.4	-	-	V	-
CTL inflow current	I <sub>ctl</sub>	-	6.0	15	μA	V <sub>ctl</sub> =3V

\* In order to measure at Ta=Tj (pulse measurement), fluctuations in output resulting from temperature fluctuations are not included.

\* Design guaranteed. (Not all products have been inspected.)

A capacitor (0.01μF) is used between pin 4 and pin 5, to improve ripple rejection.

©Not designed for radiation resistance.

BA029LBSG (unless otherwise noted, Ta=25°C, Vcc=3.9V)

Parameter	Symbol	Min.	Typ.	Max.	Unit	Coniditions
Standby current	I <sub>ccs</sub>	-	0	10	μA	V <sub>ctl</sub> =0V
Circuit current	I <sub>cca</sub>	-	65	150	μA	V <sub>ctl</sub> =3V, no output load
<Output block>						
Output voltage	V <sub>o</sub>	2.828	2.90	2.973	V	I <sub>o</sub> =50mA* <sup>1</sup>
Dropout voltage	ΔV <sub>d</sub>	-	90	150	mV	I <sub>o</sub> =50mA, V <sub>cc</sub> =0.95V <sub>o</sub>
Output current capability	I <sub>o</sub>	150	280	-	mA	-
Load regulation	Reg.L	-	40	80	mV	I <sub>o</sub> =1~50mA* <sup>1</sup>
Input regulation	Reg.I	-	3	30	mV	V <sub>cc</sub> =3.9~7V
Output noise voltage	e <sub>n</sub>	-	56	-	μV	I <sub>o</sub> =10mA, C=0.01μF* <sup>2</sup>
Ripple rejection 1	R.R1	45	58	-	dB	I <sub>o</sub> =10mA, f=400Hz
Ripple rejection 2	R.R2	-	66	-	dB	I <sub>o</sub> =10mA, f=400Hz, C=0.01μF* <sup>2</sup>
<Power-save block>						
CTL OFF voltage	V <sub>off</sub>	-	-	0.6	V	-
CTL ON voltage	V <sub>on</sub>	2.4	-	-	V	-
CTL inflow current	I <sub>ctl</sub>	-	6.0	15	μA	V <sub>ctl</sub> =3V

\* In order to measure at Ta=Tj (pulse measurement), fluctuations in output resulting from temperature fluctuations are not included.

\* Design guaranteed. (Not all products have been inspected.)

A capacitor (0.01μF) is used between pin 4 and pin 5, to improve ripple rejection.

©Not designed for radiation resistance.

## Regulator IC

BA030LBSG (unless otherwise noted, Ta=25°C, Vcc=4.0V)

Parameter	Symbol	Min.	Typ.	Max.	Unit	Coniditions
Standby current	I <sub>ccs</sub>	-	0	10	μA	V <sub>ctl</sub> =0V
Circuit current	I <sub>cca</sub>	-	65	150	μA	V <sub>ctl</sub> =3V, no output load
<Output block>						
Output voltage	V <sub>o</sub>	2.925	3.00	3.075	V	I <sub>o</sub> =50mA* <sup>1</sup>
Dropout voltage	ΔV <sub>d</sub>	-	90	150	mV	I <sub>o</sub> =50mA, V <sub>cc</sub> =0.95V <sub>o</sub>
Output current capability	I <sub>o</sub>	150	280	-	mA	-
Load regulation	Reg.L	-	40	80	mV	I <sub>o</sub> =1~50mA* <sup>1</sup>
Input regulation	Reg.I	-	3	30	mV	I <sub>o</sub> =10mA, V <sub>cc</sub> =4.0~7V* <sup>1</sup>
Output noise voltage	en	-	56	-	μV	I <sub>o</sub> =10mA, C=0.01μF* <sup>2</sup>
Ripple rejection 1	R.R1	50	58	-	dB	I <sub>o</sub> =10mA, f=400Hz
Ripple rejection 2	R.R2	-	66	-	dB	I <sub>o</sub> =10mA, f=400Hz, C=0.01μF* <sup>2</sup>
<Power-save block>						
CTL OFF voltage	V <sub>off</sub>	-	-	0.6	V	-
CTL ON voltage	V <sub>on</sub>	2.4	-	-	V	-
CTL inflow current	I <sub>ctl</sub>	-	6.0	15	μA	V <sub>ctl</sub> =3V

\* In order to measure at Ta=Tj (pulse measurement), fluctuations in output resulting from temperature fluctuations are not included.

\* Design guaranteed. (Not all products have been inspected.)

A capacitor (0.01μF) is used between pin 4 and pin 5, to improve ripple rejection.

©Not designed for radiation resistance.

BA032LBSG (unless otherwise noted, Ta=25°C, Vcc=4.2V)

Parameter	Symbol	Min.	Typ.	Max.	Unit	Coniditions
Standby current	I <sub>ccs</sub>	-	0	10	μA	V <sub>ctl</sub> =0V
Circuit current	I <sub>cca</sub>	-	65	150	μA	V <sub>ctl</sub> =3V, no output load
<Output block>						
Output voltage	V <sub>o</sub>	3.12	3.20	3.28	V	I <sub>o</sub> =50mA* <sup>1</sup>
Dropout voltage	ΔV <sub>d</sub>	-	90	150	mV	I <sub>o</sub> =50mA, V <sub>cc</sub> =0.95V <sub>o</sub>
Output current capability	I <sub>o</sub>	150	280	-	mA	-
Load regulation	Reg.L	-	40	80	mV	I <sub>o</sub> =1~50mA* <sup>1</sup>
Input regulation	Reg.I	-	3	30	mV	I <sub>o</sub> =10mA, V <sub>cc</sub> =4.2~7V* <sup>1</sup>
Output noise voltage	en	-	56	-	μV	I <sub>o</sub> =10mA, C=0.01μF* <sup>2</sup>
Ripple rejection 1	R.R1	50	58	-	dB	I <sub>o</sub> =10mA, f=400Hz
Ripple rejection 2	R.R2	-	66	-	dB	I <sub>o</sub> =10mA, f=400Hz, C=0.01μF* <sup>2</sup>
<Power-save block>						
CTL OFF voltage	V <sub>off</sub>	-	-	0.6	V	-
CTL ON voltage	V <sub>on</sub>	2.4	-	-	V	-
CTL inflow current	I <sub>ctl</sub>	-	6.0	15	μA	V <sub>ctl</sub> =3V

\* In order to measure at Ta=Tj (pulse measurement), fluctuations in output resulting from temperature fluctuations are not included.

\* Design guaranteed. (Not all products have been inspected.)

A capacitor (0.01μF) is used between pin 4 and pin 5, to improve ripple rejection.

©Not designed for radiation resistance.

## Regulator IC

BA033LBSG (unless otherwise noted, Ta=25°C, Vcc=4.3V)

Parameter	Symbol	Min.	Typ.	Max.	Unit	Coniditions
Standby current	I <sub>ccs</sub>	-	0	10	μA	V <sub>ctl</sub> =0V
Circuit current	I <sub>cca</sub>	-	65	150	μA	V <sub>ctl</sub> =3V, no output load
<Output block>						
Output voltage	V <sub>o</sub>	3.218	3.30	3.382	V	I <sub>o</sub> =50mA*1
Dropout voltage	ΔV <sub>d</sub>	-	90	150	mV	I <sub>o</sub> =50mA, V <sub>cc</sub> =0.95V <sub>o</sub>
Output current capability	I <sub>o</sub>	150	280	-	mA	-
Load regulation	Reg.L	-	40	80	mV	I <sub>o</sub> =1~50mA*1
Input regulation	Reg.I	-	3	30	mV	V <sub>cc</sub> =4.3~7V
Output noise voltage	en	-	56	-	μV	I <sub>o</sub> =10mA, C=0.01μF*2
Ripple rejection 1	R.R1	45	58	-	dB	I <sub>o</sub> =10mA, f=400Hz
Ripple rejection 2	R.R2	-	66	-	dB	I <sub>o</sub> =10mA, f=400Hz, C=0.01μF*2
<Power-save block>						
CTL OFF voltage	V <sub>off</sub>	-	-	0.6	V	-
CTL ON voltage	V <sub>on</sub>	2.4	-	-	V	-
CTL inflow current	I <sub>ctl</sub>	-	6.0	15	μA	V <sub>ctl</sub> =3V

\* In order to measure at Ta=Tj (pulse measurement), fluctuations in output resulting from temperature fluctuations are not included.

\* Design guaranteed. (Not all products have been inspected.)

A capacitor (0.01μF) is used between pin 4 and pin 5, to improve ripple rejection.

©Not designed for radiation resistance.

BA036LBSG (unless otherwise noted, Ta=25°C, Vcc=4.6V)

Parameter	Symbol	Min.	Typ.	Max.	Unit	Coniditions
Standby current	I <sub>ccs</sub>	-	0	10	μA	V <sub>ctl</sub> =0V
Circuit current	I <sub>cca</sub>	-	65	150	μA	V <sub>ctl</sub> =3V, no output load
<Output block>						
Output voltage	V <sub>o</sub>	3.51	3.60	3.69	V	I <sub>o</sub> =50mA*1
Dropout voltage	ΔV <sub>d</sub>	-	90	150	mV	I <sub>o</sub> =50mA, V <sub>cc</sub> =0.95V <sub>o</sub>
Output current capability	I <sub>o</sub>	150	280	-	mA	-
Load regulation	Reg.L	-	40	80	mV	I <sub>o</sub> =1~50mA*1
Input regulation	Reg.I	-	3	30	mV	V <sub>cc</sub> =4.6~7V
Output noise voltage	en	-	56	-	μV	I <sub>o</sub> =10mA, C=0.01μF*2
Ripple rejection 1	R.R1	45	56	-	dB	I <sub>o</sub> =10mA, f=400Hz
Ripple rejection 2	R.R2	-	66	-	dB	I <sub>o</sub> =10mA, f=400Hz, C=0.01μF*2
<Power-save block>						
CTL OFF voltage	V <sub>off</sub>	-	-	0.6	V	-
CTL ON voltage	V <sub>on</sub>	2.4	-	-	V	-
CTL inflow current	I <sub>ctl</sub>	-	6.0	15	μA	V <sub>ctl</sub> =3V

\* In order to measure at Ta=Tj (pulse measurement), fluctuations in output resulting from temperature fluctuations are not included.

\* Design guaranteed. (Not all products have been inspected.)

A capacitor (0.01μF) is used between pin 4 and pin 5, to improve ripple rejection.

©Not designed for radiation resistance.

## Regulator IC

BA038LBSG (unless otherwise noted, Ta=25°C, Vcc=4.8V)

Parameter	Symbol	Min.	Typ.	Max.	Unit	Coniditions
Standby current	I <sub>ccs</sub>	-	0	10	μA	V <sub>ctl</sub> =0V
Circuit current	I <sub>cca</sub>	-	65	150	μA	V <sub>ctl</sub> =3V, no output load
<Output block>						
Output voltage	V <sub>o</sub>	3.705	3.80	3.895	V	I <sub>o</sub> =50mA* <sup>1</sup>
Dropout voltage	ΔV <sub>d</sub>	-	90	150	mV	I <sub>o</sub> =50mA, V <sub>cc</sub> =0.95V <sub>o</sub>
Output current capability	I <sub>o</sub>	150	280	-	mA	-
Load regulation	Reg.L	-	40	80	mV	I <sub>o</sub> =1~50mA* <sup>1</sup>
Input regulation	Reg.I	-	3	30	mV	I <sub>o</sub> =10mA, V <sub>cc</sub> =4.8~7V* <sup>1</sup>
Output noise voltage	en	-	56	-	μV	I <sub>o</sub> =10mA, C=0.01μF* <sup>2</sup>
Ripple rejection 1	R.R1	50	56	-	dB	I <sub>o</sub> =10mA, f=400Hz
Ripple rejection 2	R.R2	-	66	-	dB	I <sub>o</sub> =10mA, f=400Hz, C=0.01μF* <sup>2</sup>
<Power-save block>						
CTL OFF voltage	V <sub>off</sub>	-	-	0.6	V	-
CTL ON voltage	V <sub>on</sub>	2.4	-	-	V	-
CTL inflow current	I <sub>ctl</sub>	-	6.0	15	μA	V <sub>ctl</sub> =3V

\* In order to measure at Ta=Tj (pulse measurement), fluctuations in output resulting from temperature fluctuations are not included.

\* Design guaranteed. (Not all products have been inspected.)

A capacitor (0.01μF) is used between pin 4 and pin 5, to improve ripple rejection.

©Not designed for radiation resistance.

BA040LBSG (unless otherwise noted, Ta=25°C, Vcc=5.0V)

Parameter	Symbol	Min.	Typ.	Max.	Unit	Coniditions
Standby current	I <sub>ccs</sub>	-	0	10	μA	V <sub>ctl</sub> =0V
Circuit current	I <sub>cca</sub>	-	65	150	μA	V <sub>ctl</sub> =3V, no output load
<Output block>						
Output voltage	V <sub>o</sub>	3.90	4.00	4.10	V	I <sub>o</sub> =50mA* <sup>1</sup>
Dropout voltage	ΔV <sub>d</sub>	-	90	150	mV	I <sub>o</sub> =50mA, V <sub>cc</sub> =0.95V <sub>o</sub>
Output current capability	I <sub>o</sub>	150	280	-	mA	-
Load regulation	Reg.L	-	40	80	mV	I <sub>o</sub> =1~50mA* <sup>1</sup>
Input regulation	Reg.I	-	3	30	mV	V <sub>cc</sub> =5.0~7V
Output noise voltage	en	-	56	-	μV	I <sub>o</sub> =10mA, C=0.01μF* <sup>2</sup>
Ripple rejection 1	R.R1	45	56	-	dB	I <sub>o</sub> =10mA, f=400Hz
Ripple rejection 2	R.R2	-	66	-	dB	I <sub>o</sub> =10mA, f=400Hz, C=0.01μF* <sup>2</sup>
<Power-save block>						
CTL OFF voltage	V <sub>off</sub>	-	-	0.6	V	-
CTL ON voltage	V <sub>on</sub>	2.4	-	-	V	-
CTL inflow current	I <sub>ctl</sub>	-	6.0	15	μA	V <sub>ctl</sub> =3V

\* In order to measure at Ta=Tj (pulse measurement), fluctuations in output resulting from temperature fluctuations are not included.

\* Design guaranteed. (Not all products have been inspected.)

A capacitor (0.01μF) is used between pin 4 and pin 5, to improve ripple rejection.

©Not designed for radiation resistance.

Regulator IC

BA050LBSG (unless otherwise noted,  $T_a=25^{\circ}\text{C}$ ,  $V_{cc}=6.0\text{V}$ )

Parameter	Symbol	Min.	Typ.	Max.	Unit	Coniditions
Standby current	$I_{ccs}$	-	0	10	$\mu\text{A}$	$V_{ctl}=0\text{V}$
Circuit current	$I_{cca}$	-	65	150	$\mu\text{A}$	$V_{ctl}=3\text{V}$ , no output load
<Output block>						
Output voltage	$V_o$	4.875	5.00	5.125	V	$I_o=50\text{mA}^{*1}$
Dropout voltage	$\Delta V_d$	-	90	150	mV	$I_o=50\text{mA}$ , $V_{cc}=0.95V_o$
Output current capability	$I_o$	150	280	-	mA	-
Load regulation	Reg.L	-	40	80	mV	$I_o=1\sim 50\text{mA}^{*1}$
Input regulation	Reg.I	-	3	30	mV	$V_{cc}=6.0\sim 7\text{V}$
Output noise voltage	$e_n$	-	56	-	$\mu\text{V}$	$I_o=10\text{mA}$ , $C=0.01\mu\text{F}^{*2}$
Ripple rejection 1	R.R1	45	54	-	dB	$I_o=10\text{mA}$ , $f=400\text{Hz}$
Ripple rejection 2	R.R2	-	66	-	dB	$I_o=10\text{mA}$ , $f=400\text{Hz}$ , $C=0.01\mu\text{F}^{*2}$
<Power-save block>						
CTL OFF voltage	$V_{off}$	-	-	0.6	V	-
CTL ON voltage	$V_{on}$	2.4	-	-	V	-
CTL inflow current	$I_{ctl}$	-	6.0	15	$\mu\text{A}$	$V_{ctl}=3\text{V}$

\* In order to measure at  $T_a \approx T_j$  (pulse measurement), fluctuations in output resulting from temperature fluctuations are not included.

\* Design guaranteed. (Not all products have been inspected.)

A capacitor (0.01 $\mu\text{F}$ ) is used between pin 4 and pin 5, to improve ripple rejection.

©Not designed for radiation resistance.

●Application example

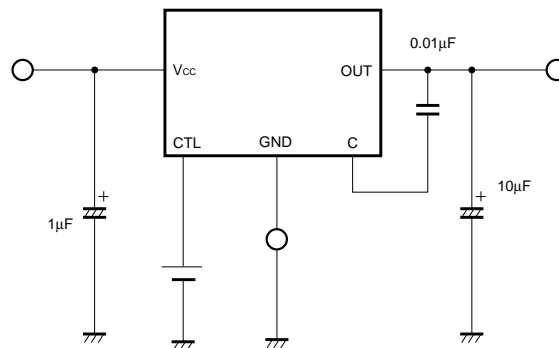
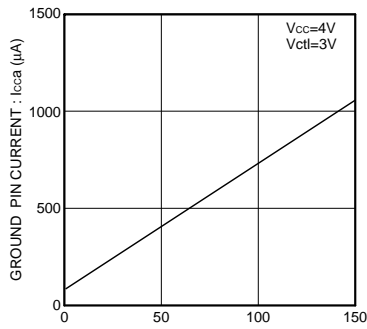

Fig.1

Regulator IC

●Electrical characteristic curves (BA030LBSG)



LOAD CURRENT :  $I_O$  (mA)  
Fig.2  $I_{GCC}$  vs.  $I_O$

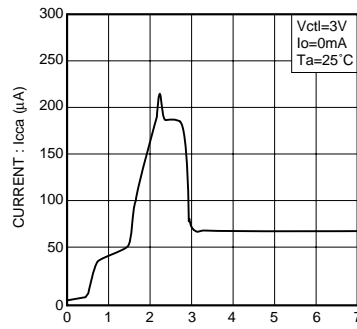

SUPPLY VOLTAGE :  $V_{CC}$  (V)  
Fig.3  $I_{GCC}$  vs.  $V_{CC}$

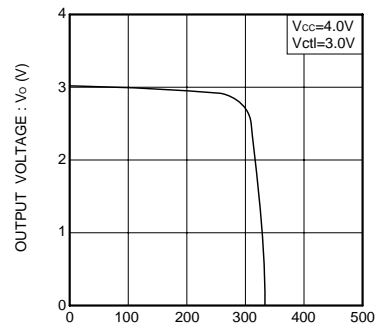

LOAD CURRENT :  $I_O$  (mA)  
Fig.4  $I_O$  vs.  $V_O$

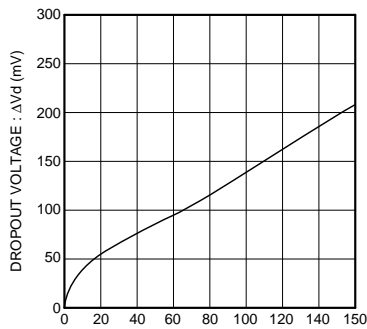

OUTPUT CURRENT :  $I_O$  (mA)  
Fig.5  $\Delta V_d$  vs.  $I_O$

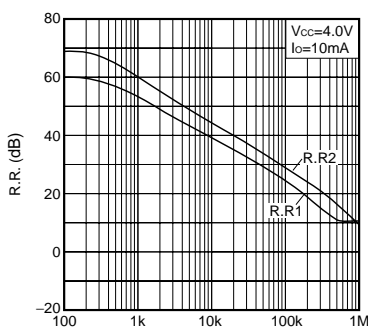

FREQUENCY :  $f$  (Hz)  
Fig.6 R.R. vs.  $f$  characteristics

●External dimensions (Units : mm)

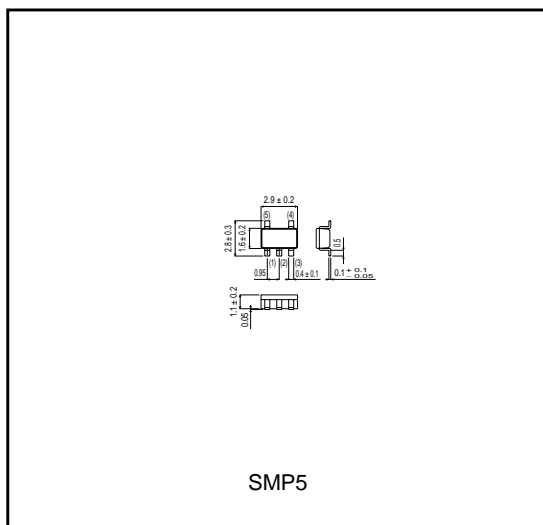



### Notes

- No technical content pages of this document may be reproduced in any form or transmitted by any means without prior permission of ROHM CO.,LTD.
- The contents described herein are subject to change without notice. The specifications for the product described in this document are for reference only. Upon actual use, therefore, please request that specifications to be separately delivered.
- Application circuit diagrams and circuit constants contained herein are shown as examples of standard use and operation. Please pay careful attention to the peripheral conditions when designing circuits and deciding upon circuit constants in the set.
- Any data, including, but not limited to application circuit diagrams information, described herein are intended only as illustrations of such devices and not as the specifications for such devices. ROHM CO.,LTD. disclaims any warranty that any use of such devices shall be free from infringement of any third party's intellectual property rights or other proprietary rights, and further, assumes no liability of whatsoever nature in the event of any such infringement, or arising from or connected with or related to the use of such devices.
- Upon the sale of any such devices, other than for buyer's right to use such devices itself, resell or otherwise dispose of the same, no express or implied right or license to practice or commercially exploit any intellectual property rights or other proprietary rights owned or controlled by
- ROHM CO., LTD. is granted to any such buyer.
- Products listed in this document use silicon as a basic material.  
Products listed in this document are no antiradiation design.

The products listed in this document are designed to be used with ordinary electronic equipment or devices (such as audio visual equipment, office-automation equipment, communications devices, electrical appliances and electronic toys).

Should you intend to use these products with equipment or devices which require an extremely high level of reliability and the malfunction of which would directly endanger human life (such as medical instruments, transportation equipment, aerospace machinery, nuclear-reactor controllers, fuel controllers and other safety devices), please be sure to consult with our sales representative in advance.

#### About Export Control Order in Japan

Products described herein are the objects of controlled goods in Annex 1 (Item 16) of Export Trade Control Order in Japan.

In case of export from Japan, please confirm if it applies to "objective" criteria or an "informed" (by MITI clause) on the basis of "catch all controls for Non-Proliferation of Weapons of Mass Destruction.

# Mouser Electronics

Authorized Distributor

Click to View Pricing, Inventory, Delivery & Lifecycle Information:

[ROHM Semiconductor:](#)

[BA030LBSG2-TR](#) [BA036LBSG2-TR](#)

Компания «Океан Электроники» предлагает заключение долгосрочных отношений при поставках импортных электронных компонентов на взаимовыгодных условиях!

Наши преимущества:

- Поставка оригинальных импортных электронных компонентов напрямую с производств Америки, Европы и Азии, а так же с крупнейших складов мира;
- Широкая линейка поставок активных и пассивных импортных электронных компонентов (более 30 млн. наименований);
- Поставка сложных, дефицитных, либо снятых с производства позиций;
- Оперативные сроки поставки под заказ (от 5 рабочих дней);
- Экспресс доставка в любую точку России;
- Помощь Конструкторского Отдела и консультации квалифицированных инженеров;
- Техническая поддержка проекта, помощь в подборе аналогов, поставка прототипов;
- Поставка электронных компонентов под контролем ВП;
- Система менеджмента качества сертифицирована по Международному стандарту ISO 9001;
- При необходимости вся продукция военного и аэрокосмического назначения проходит испытания и сертификацию в лаборатории (по согласованию с заказчиком);
- Поставка специализированных компонентов военного и аэрокосмического уровня качества (Xilinx, Altera, Analog Devices, Intersil, Interpoint, Microsemi, Actel, Aeroflex, Peregrine, VPT, Syfer, Eurofarad, Texas Instruments, MS Kennedy, Miteq, Cobham, E2V, MA-COM, Hittite, Mini-Circuits, General Dynamics и др.);

Компания «Океан Электроники» является официальным дистрибьютором и эксклюзивным представителем в России одного из крупнейших производителей разъемов военного и аэрокосмического назначения «JONHON», а так же официальным дистрибьютором и эксклюзивным представителем в России производителя высокотехнологичных и надежных решений для передачи СВЧ сигналов «FORSTAR».



## JONHON

«JONHON» (основан в 1970 г.)

Разъемы специального, военного и аэрокосмического назначения:

(Применяются в военной, авиационной, аэрокосмической, морской, железнодорожной, горно- и нефтедобывающей отраслях промышленности)

«FORSTAR» (основан в 1998 г.)

ВЧ соединители, коаксиальные кабели,  
кабельные сборки и микроволновые компоненты:

(Применяются в телекоммуникациях гражданского и специального назначения, в средствах связи, РЛС, а так же военной, авиационной и аэрокосмической отраслях промышленности).



Телефон: 8 (812) 309-75-97 (многоканальный)

Факс: 8 (812) 320-03-32

Электронная почта: [ocean@oceanchips.ru](mailto:ocean@oceanchips.ru)

Web: <http://oceanchips.ru/>

Адрес: 198099, г. Санкт-Петербург, ул. Калинина, д. 2, корп. 4, лит. А