

# 97×33 mm

## San Ace B97 9BMB type



### General Specifications

- Material ..... Frame: Plastic (Flammability: UL 94V-0), Impeller: Plastic (Flammability: UL 94V-0)
- Expected life ..... See the table below. (L10 life: 90% survival rate for continuous operation in free air at 60°C, rated voltage)
- Motor protection function ..... Locked rotor burnout protection, Reverse polarity protection  
For details, please refer to p. 547.
- Dielectric strength ..... 50/60 Hz, 500 VAC, for 1 minute (between lead wire conductors and frame)
- Insulation resistance ..... 10 MΩ or more with a 500 VDC megger (between lead wire conductors and frame)
- Sound pressure level (SPL) ..... At 1 m away from the air inlet
- Storage temperature ..... -30 to +70°C (Non-condensing)
- Lead wire ..... ⊕Red ⊖Black (Sensor) Yellow (Control) Brown  
(For models without PWM control function, there is no speed control wiring.)
- Mass ..... 190 g

### Specifications

The models listed below **have pulse sensors with PWM control function.**

Model no.	Rated voltage [V]	Operating voltage range [V]	PWM duty cycle* [%]	Rated current [A]	Rated input [W]	Rated speed [min <sup>-1</sup> ]	Max. airflow [m <sup>3</sup> /min] [CFM]	Max. static pressure [Pa] [inchH <sub>2</sub> O]	SPL [dB (A)]	Operating temperature [°C]	Expected life [h]
9BMB12P2K01	12	10.8 to 13.2	100	3.4	40.8	6850	1.61 56.8	1280 5.14	66	-20 to +70	40000/60°C
9BMB12P2G01			100	1.8	21.6	5750	1.34 47.3	760 3.05	61		
9BMB12P2S01		10.2 to 13.8	100	1.4	16.8	5250	1.22 43.1	610 2.45	59		
9BMB12P2H01			100	1.1	13.2	4850	1.11 39.2	490 1.968	57		
9BMB12P2F01			100	0.9	10.8	4500	1.04 36.7	410 1.64	56		
9BMB24P2K01	24	21.6 to 26.4	100	1.62	38.88	6850	1.61 56.8	1280 5.14	66		
9BMB24P2G01			100	0.83	19.92	5750	1.34 47.3	760 3.05	61		
9BMB24P2S01			100	0.7	16.8	5250	1.22 43.1	610 2.45	59		
9BMB24P2H01			100	0.55	13.2	4850	1.11 39.2	490 1.968	57		
9BMB24P2F01			100	0.45	10.8	4500	1.04 36.7	410 1.64	56		

\* PWM frequency: 25 kHz. Fan does not rotate when PWM duty cycle is 0%.

The following sensor and control options are available for selection.

Available for all models. **Without sensor** **Pulse sensor**

Differs according to the model. Refer to the table on pp. 566 to 567. **Lock sensor**

The models listed below **have pulse sensors.**

Model no.	Rated voltage [V]	Operating voltage range [V]	Rated current [A]	Rated input [W]	Rated speed [min <sup>-1</sup> ]	Max. airflow [m <sup>3</sup> /min] [CFM]	Max. static pressure [Pa] [inchH <sub>2</sub> O]	SPL [dB (A)]	Operating temperature [°C]	Expected life [h]
9BMB12K201	12	7 to 13.2	3.4	40.8	6850	1.61 56.8	1280 5.14	66	-20 to +70	40000/60°C
9BMB12G201			1.8	21.6	5750	1.34 47.3	760 3.052	61		
9BMB12S201			1.4	16.8	5250	1.22 43.1	610 2.45	59		
9BMB12H201			1.1	13.2	4850	1.11 39.2	490 1.968	57		
9BMB12F201			0.9	10.8	4500	1.04 36.7	410 1.647	56		
9BMB24K201	24	12 to 26.4	1.62	38.88	6850	1.61 56.8	1280 5.14	66		
9BMB24G201			0.83	19.9	5750	1.34 47.3	760 3.052	61		
9BMB24S201			0.7	16.8	5250	1.22 43.1	610 2.45	59		
9BMB24H201			0.55	13.2	4850	1.11 39.2	490 1.968	57		
9BMB24F201			0.45	10.8	4500	1.04 36.7	410 1.647	56		

The following sensor and control options are available for selection.

Available for all models. **Without sensor** **PWM control**

Differs according to the model. Refer to the table on pp. 566 to 567. **Lock sensor**

# Airflow - Static Pressure Characteristics / PWM Duty - Speed Characteristics Example

## 9BMB12P2K01 With pulse sensor with PWM control function

PWM duty cycle

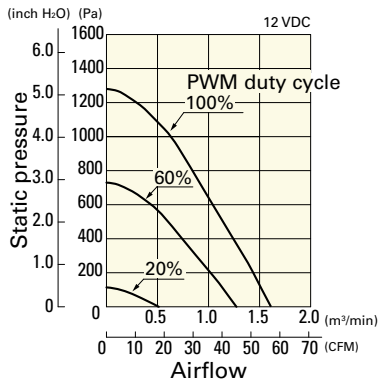

Operating voltage range

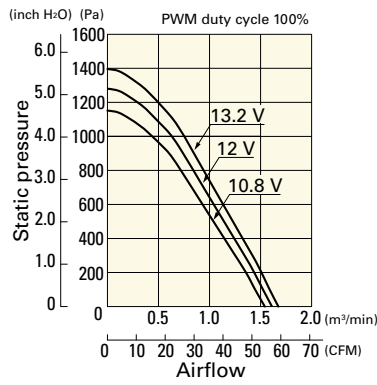

PWM duty - Speed characteristics example

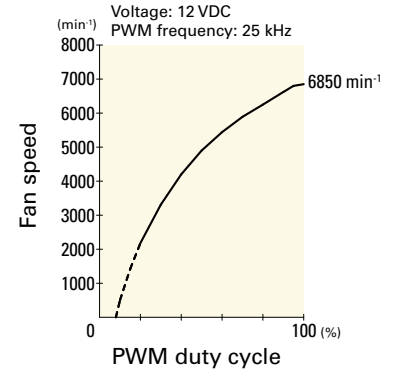

## 9BMB12P2G01 With pulse sensor with PWM control function

PWM duty cycle

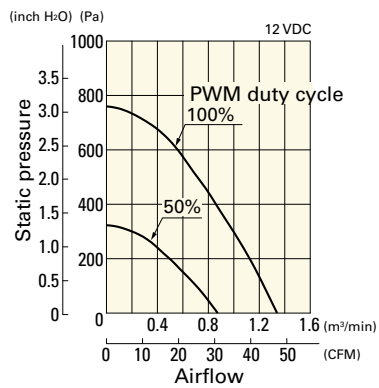

Operating voltage range

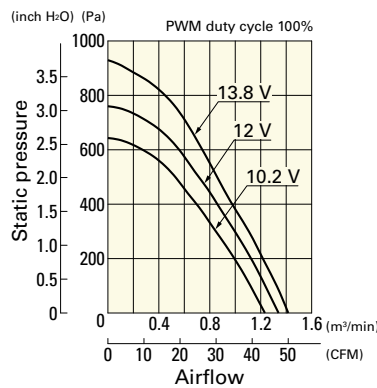

PWM duty - Speed characteristics example

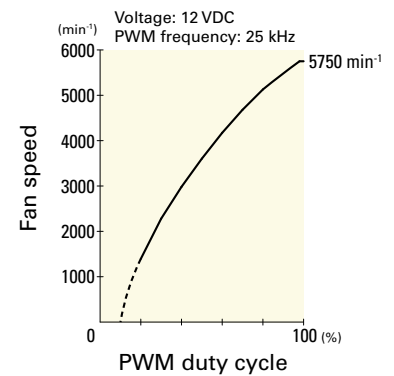

## 9BMB12P2S01 With pulse sensor with PWM control function

PWM duty cycle

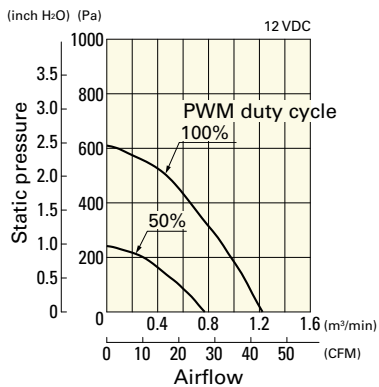

Operating voltage range

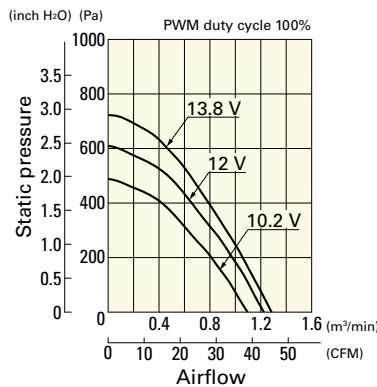

PWM duty - Speed characteristics example

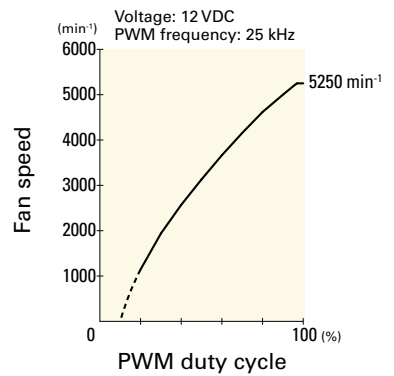

## 9BMB12P2H01 With pulse sensor with PWM control function

PWM duty cycle

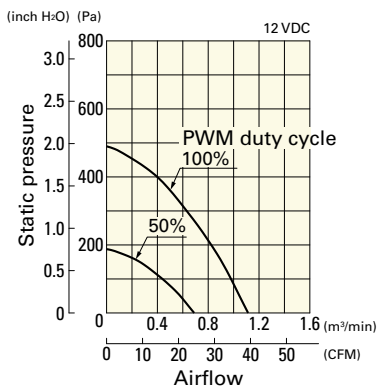

Operating voltage range

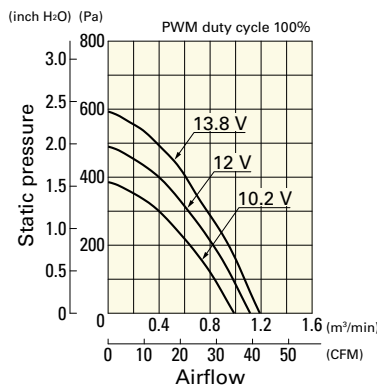

PWM duty - Speed characteristics example

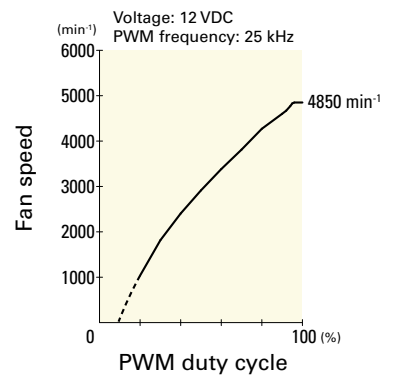

Blower 97 mm DC

# Airflow - Static Pressure Characteristics / PWM Duty - Speed Characteristics Example

**9BMB12P2F01** With pulse sensor with PWM control function

PWM duty cycle

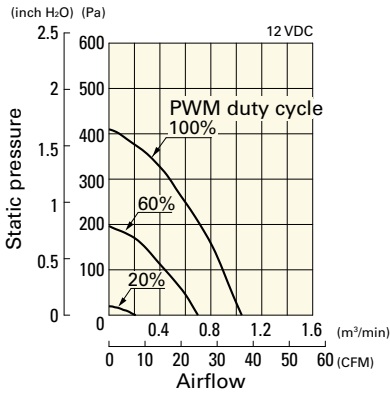

Operating voltage range

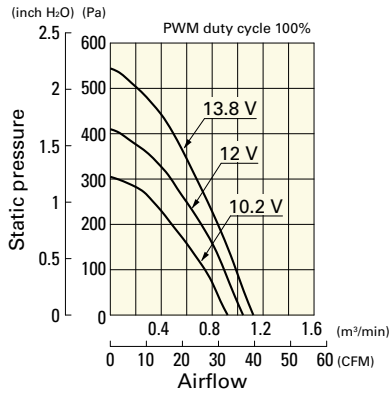

PWM duty - Speed characteristics example

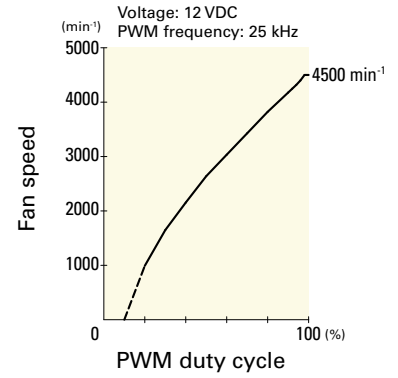

**9BMB24P2K01** With pulse sensor with PWM control function

PWM duty cycle

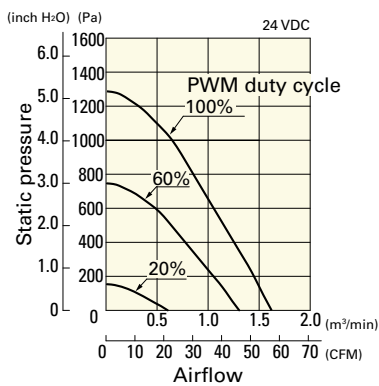

Operating voltage range

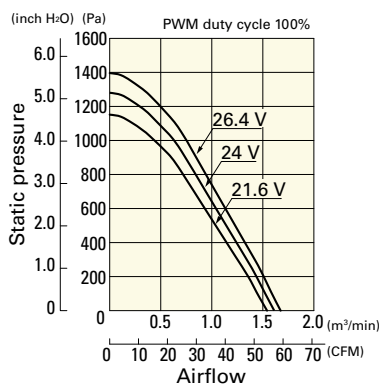

PWM duty - Speed characteristics example

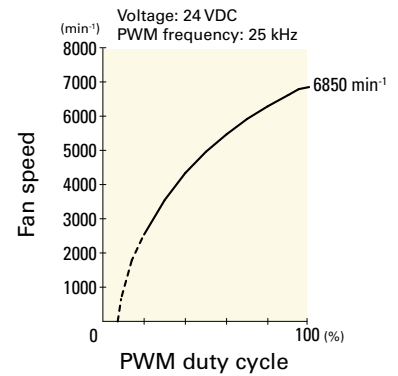

**9BMB24P2G01** With pulse sensor with PWM control function

PWM duty cycle

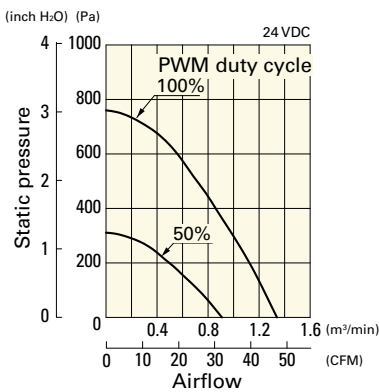

Operating voltage range

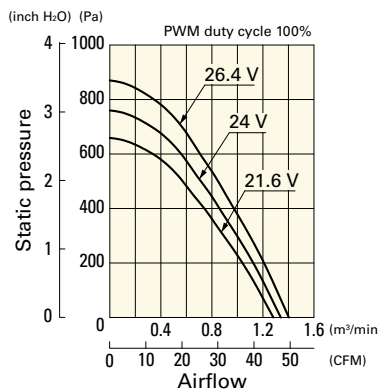

PWM duty - Speed characteristics example

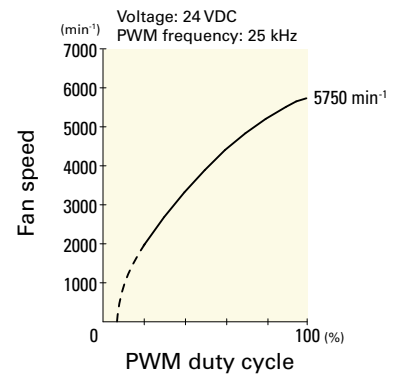

**9BMB24P2S01** With pulse sensor with PWM control function

PWM duty cycle

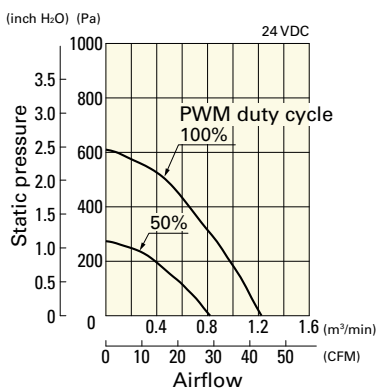

Operating voltage range

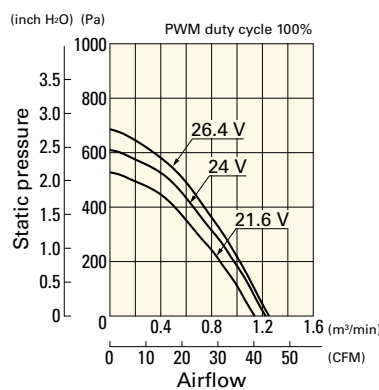

PWM duty - Speed characteristics example

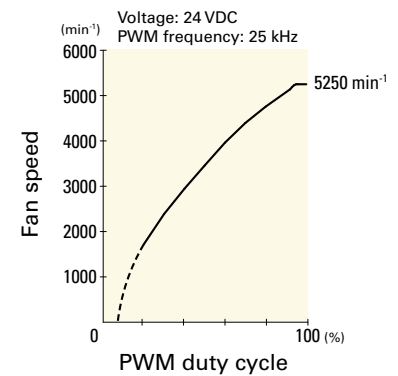

# Airflow - Static Pressure Characteristics / PWM Duty - Speed Characteristics Example

## 9BMB24P2H01 With pulse sensor with PWM control function

PWM duty cycle

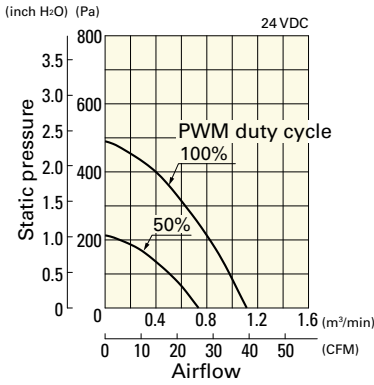

Operating voltage range

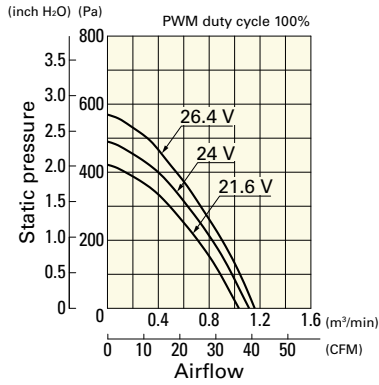

PWM duty - Speed characteristics example

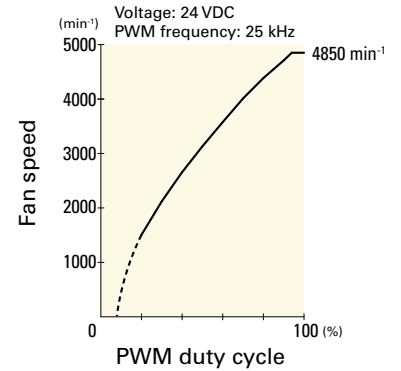

## 9BMB24P2F01 With pulse sensor with PWM control function

PWM duty cycle

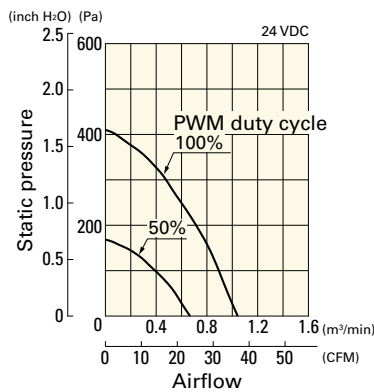

Operating voltage range

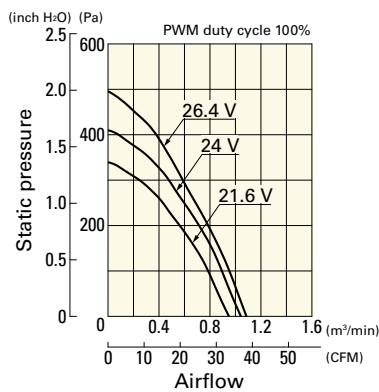

PWM duty - Speed characteristics example

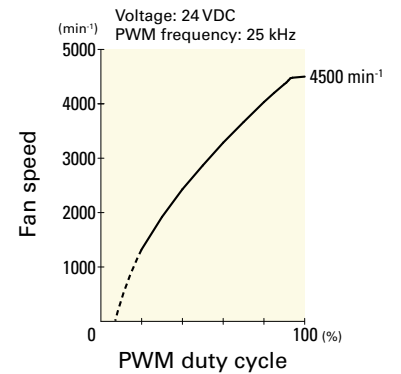

## 9BMB12K201 With pulse sensor

Operating voltage range

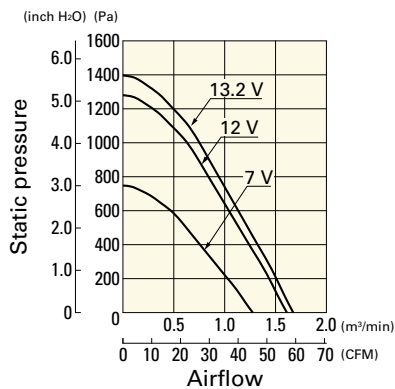

## 9BMB12G201 With pulse sensor

Operating voltage range

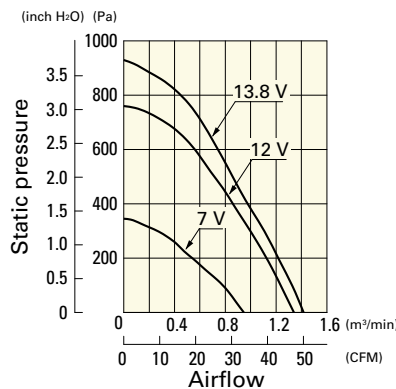

## 9BMB12S201 With pulse sensor

Operating voltage range

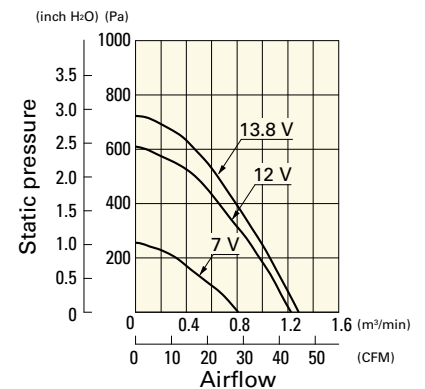

## 9BMB12H201 With pulse sensor

Operating voltage range

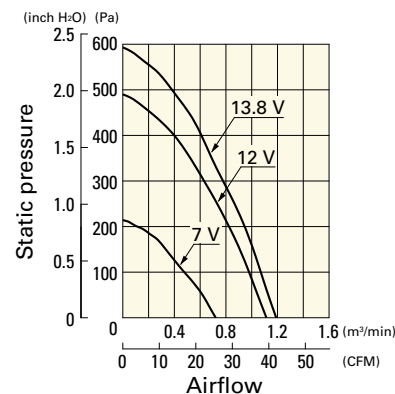

## 9BMB12F201 With pulse sensor

Operating voltage range

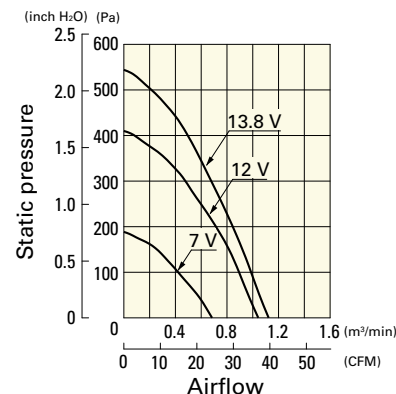

## 9BMB24K201 With pulse sensor

Operating voltage range

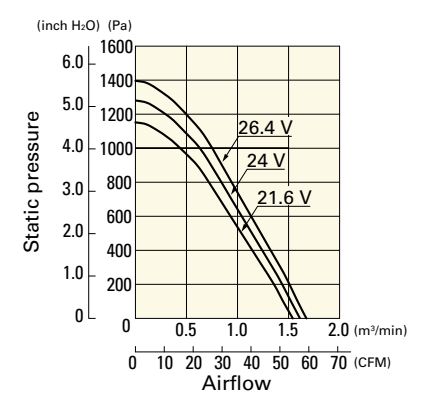

Blower 97 mm DC

## Airflow - Static Pressure Characteristics

### 9BMB24G201 With pulse sensor

Operating voltage range

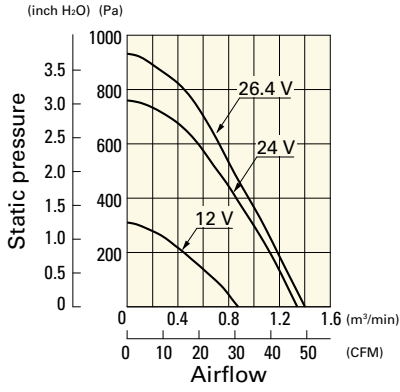

### 9BMB24S201 With pulse sensor

Operating voltage range

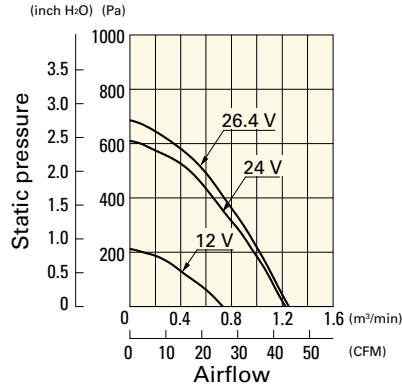

### 9BMB24H201 With pulse sensor

Operating voltage range

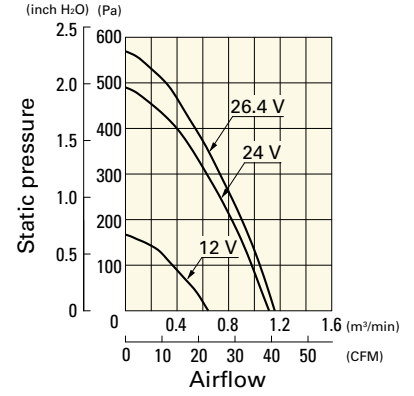

### 9BMB24F201 With pulse sensor

Operating voltage range

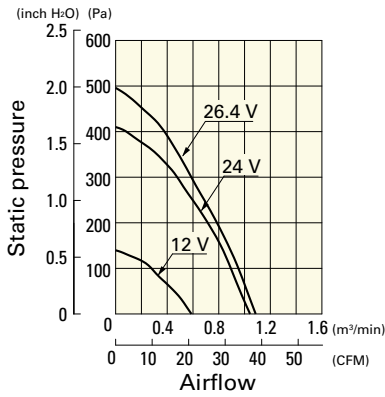

## Dimensions (unit: mm) (With pulse sensor with PWM control function)

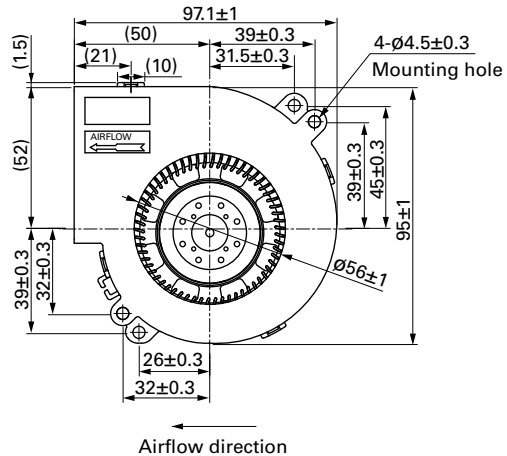
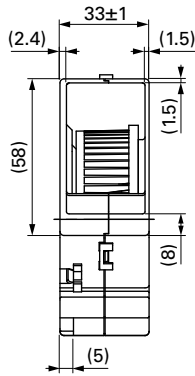
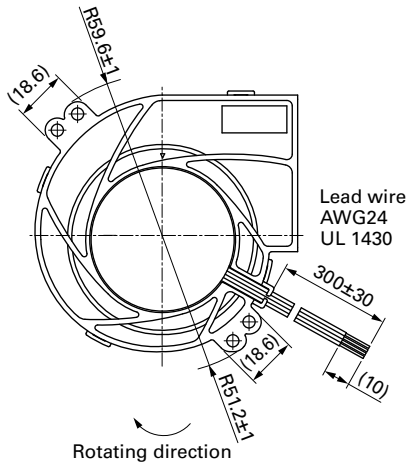

Компания «Океан Электроники» предлагает заключение долгосрочных отношений при поставках импортных электронных компонентов на взаимовыгодных условиях!

Наши преимущества:

- Поставка оригинальных импортных электронных компонентов напрямую с производств Америки, Европы и Азии, а так же с крупнейших складов мира;
- Широкая линейка поставок активных и пассивных импортных электронных компонентов (более 30 млн. наименований);
- Поставка сложных, дефицитных, либо снятых с производства позиций;
- Оперативные сроки поставки под заказ (от 5 рабочих дней);
- Экспресс доставка в любую точку России;
- Помощь Конструкторского Отдела и консультации квалифицированных инженеров;
- Техническая поддержка проекта, помощь в подборе аналогов, поставка прототипов;
- Поставка электронных компонентов под контролем ВП;
- Система менеджмента качества сертифицирована по Международному стандарту ISO 9001;
- При необходимости вся продукция военного и аэрокосмического назначения проходит испытания и сертификацию в лаборатории (по согласованию с заказчиком);
- Поставка специализированных компонентов военного и аэрокосмического уровня качества (Xilinx, Altera, Analog Devices, Intersil, Interpoint, Microsemi, Actel, Aeroflex, Peregrine, VPT, Syfer, Eurofarad, Texas Instruments, MS Kennedy, Miteq, Cobham, E2V, MA-COM, Hittite, Mini-Circuits, General Dynamics и др.);

Компания «Океан Электроники» является официальным дистрибьютором и эксклюзивным представителем в России одного из крупнейших производителей разъемов военного и аэрокосмического назначения «JONHON», а так же официальным дистрибьютором и эксклюзивным представителем в России производителя высокотехнологичных и надежных решений для передачи СВЧ сигналов «FORSTAR».



## JONHON

«JONHON» (основан в 1970 г.)

Разъемы специального, военного и аэрокосмического назначения:

(Применяются в военной, авиационной, аэрокосмической, морской, железнодорожной, горно- и нефтедобывающей отраслях промышленности)

«FORSTAR» (основан в 1998 г.)

ВЧ соединители, коаксиальные кабели, кабельные сборки и микроволновые компоненты:

(Применяются в телекоммуникациях гражданского и специального назначения, в средствах связи, РЛС, а так же военной, авиационной и аэрокосмической отраслях промышленности).



Телефон: 8 (812) 309-75-97 (многоканальный)

Факс: 8 (812) 320-03-32

Электронная почта: [ocean@oceanchips.ru](mailto:ocean@oceanchips.ru)

Web: <http://oceanchips.ru/>

Адрес: 198099, г. Санкт-Петербург, ул. Калинина, д. 2, корп. 4, лит. А