

Features

- 3535 IR LED
- ROHS and REACH Compliant
- Vertical Patent Free Chip
- ESD 2KV

Applications

- IP Cam
- Security
- Industrial facility applications

Description

The IN-C33(X)TOIR is a high-power IR LED. It is a SMD type LED which can be used in various applications.



Outline(mm)			
30D	60D	120D	90D
3.5x3.5x3.38	3.5x3.5x2.8	3.5x3.5x2.0	3.5x3.5x2.34
IN-C33ATOIR	IN-C33BTOIR	IN-C33CTOIR	IN-C33ETOIR

Recommended Solder Pattern

(Suggest Stencil t=0.12 mm)

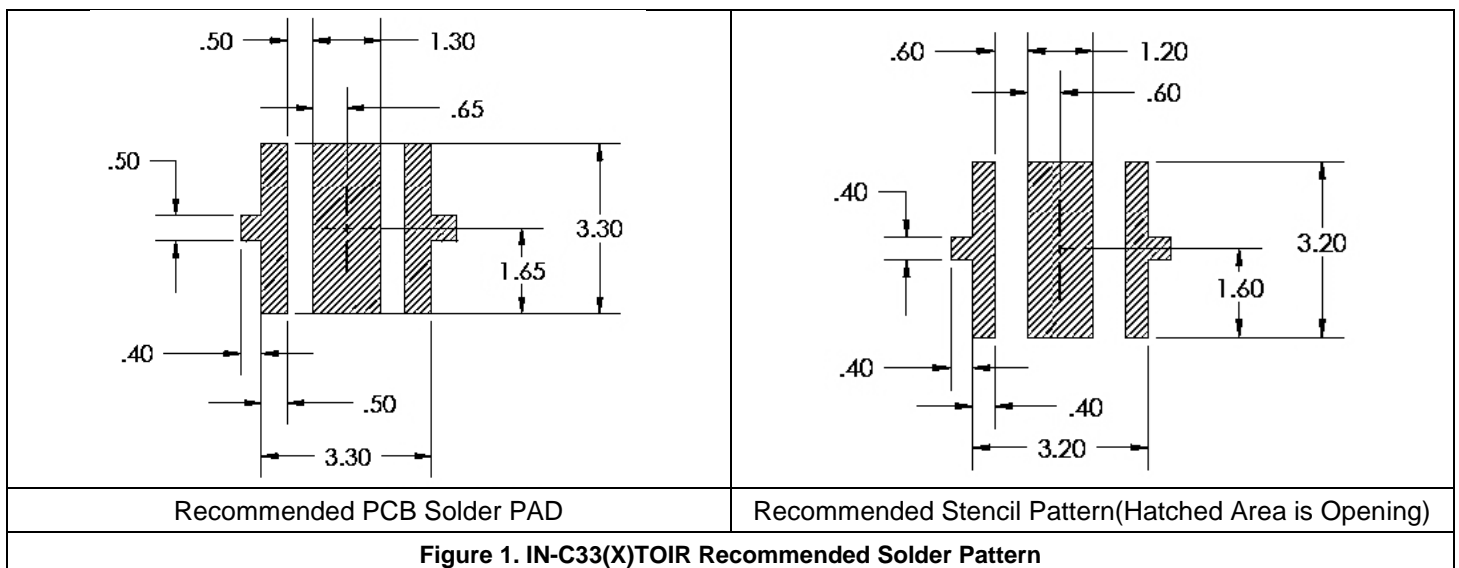

Package Dimensions

(All dimensions are in mm, tolerance is $\pm 0.13\text{mm}$)

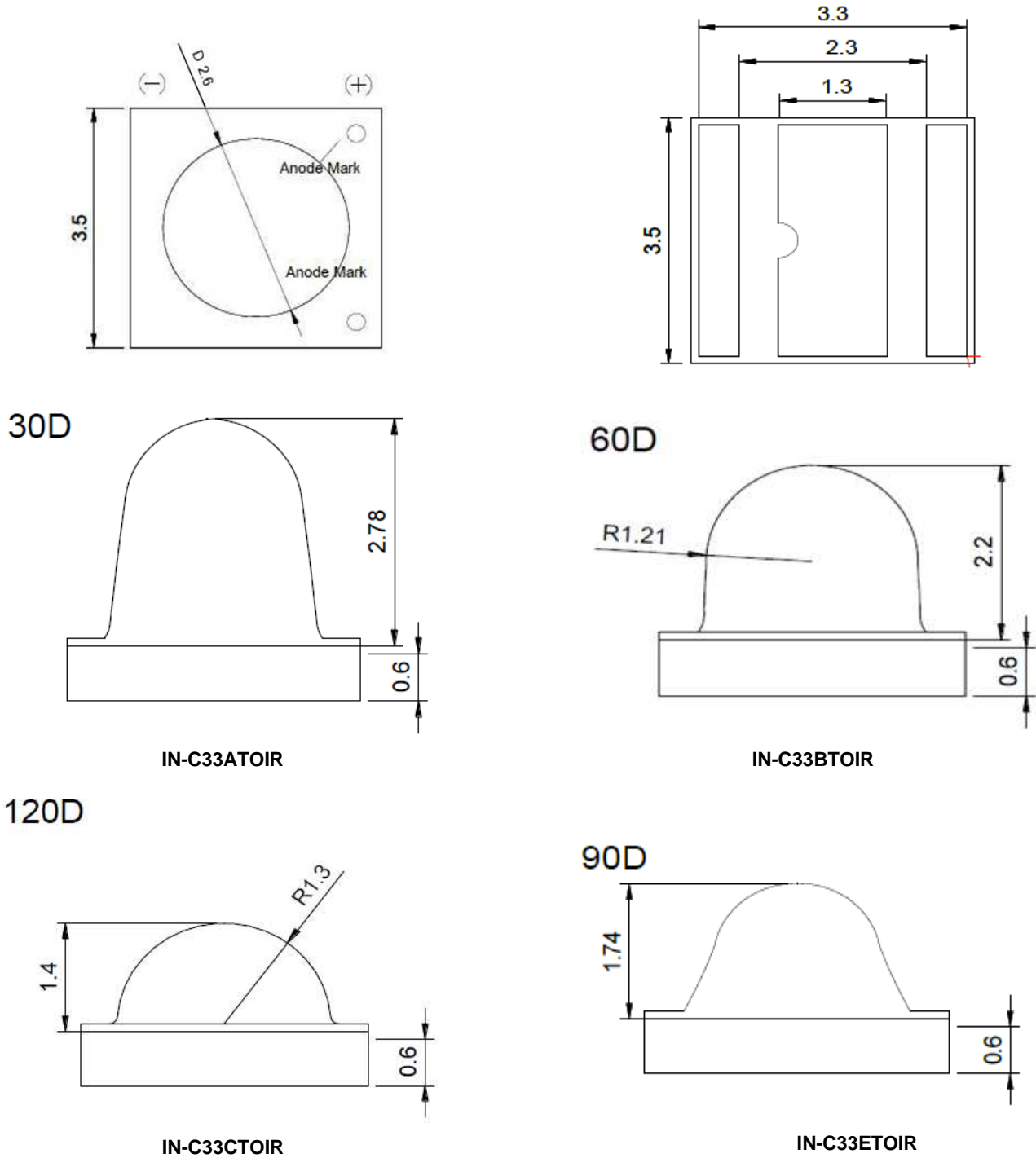

Figure 2. IN-C33(X)TOIR Package Dimension

Absolute Maximum Rating at 25°C (Note 1)

Product	I _F (mA) max	I _{FP} * (mA)	V _R (V)	I _R (μA) max	T _J (°C)	T _{ST} (°C)	R _{th} (°C/W)	Soldering Temp. T _{sol} (°C)
IN-C33ATOIR IN-C33BTOIR IN-C33CTOIR IN-C33ETOIR	1000	1200	-5	10	125 °C	-40°C~+100°C	10	260 °C

Notes

1. Condition for I_{FP} is pulse of 1/10 duty and 0.1msec width
2. When driving at maximum current the T_J must be kept below 125°C

Electrical Characteristics T_A = 25°C (Note 1)

Product	V _F (V)@1000mA			Beam Angle			
	min	typ.	max	IN-C33ATOIR	IN-C33BTOIR	IN-C33CTOIR	IN-C33ETOIR
IN-C33ATOIR IN-C33BTOIR IN-C33CTOIR IN-C33ETOIR	1.4	---	2.6	30	60	120	90

Notes

1. Performance guaranteed only under conditions listed in above tables.
2. Viewing angle(2θ1/2) ± 10°
3. Detail binning information on page 5.

ESD Precaution

ATTENTION: Electrostatic Discharge (ESD) protection



The symbol above denotes that ESD precaution is needed. ESD protection for GaP and AlGaAs based chips is necessary even though they are relatively safe in the presence of low static-electric discharge. Parts built with AlInGaP, GaN, or/and InGaN based chips are STATIC SENSITIVE devices. ESD precaution must be taken during design and assembly. If manual work or processing is needed, please ensure the device is adequately protected from ESD during the process.

Please be advised that normal static precautions should be taken in the handling and assembly of this device to prevent damage or degradation which may be induced by electrostatic discharge (ESD).

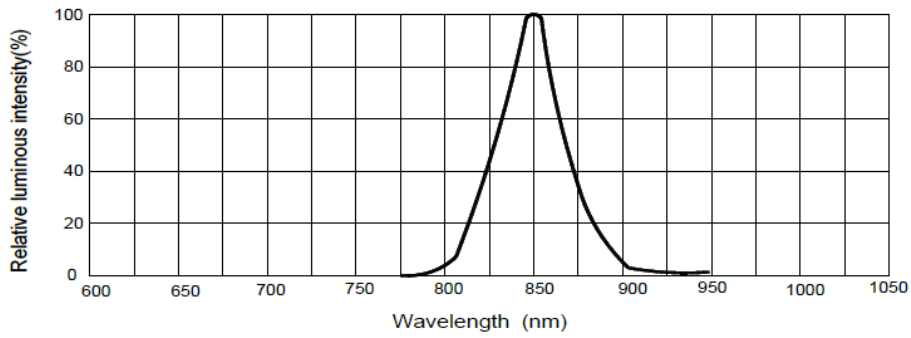
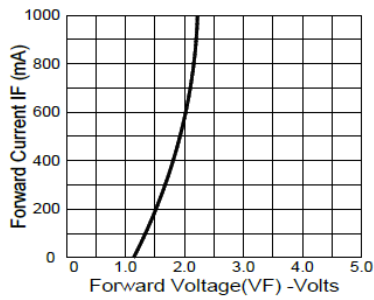
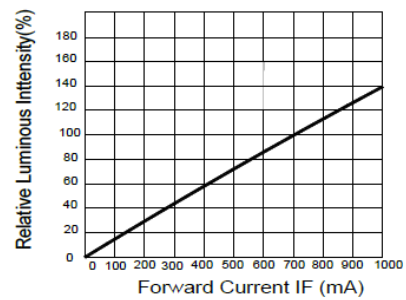
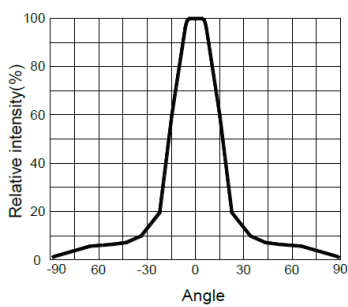
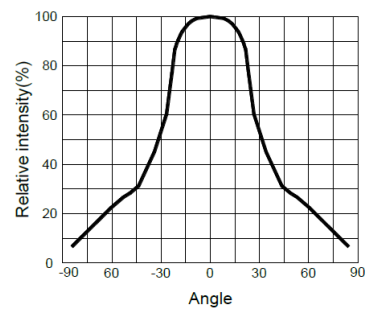
Electronic-Optical Characteristics
Spectrum Distribution

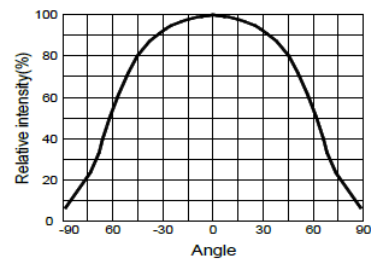
Forward Current VS. Forward Voltage

Luminous Intensity VS. Forward Current

Beam angle (2θ1/2)
Beam Angle 30D

Beam Angle 60D

Beam Angle 90D

Beam Angle 120D

Notes:

Viewing angle(2θ1/2) ± 10°

Ordering Information

Orderable Part Number	Peak Wavelength (nm)	Radiometric Power (mW) @1000mA			Forward Voltage (V)		Angle
		Group	Min	Max	Min	Max	
IN-C33ATOIR	840-850	A	450	500	1.6	1.8	30°
		B	500	550	1.8	2.0	30°
	850-860	C	550	600	2.0	2.2	30°
		D	600	650	2.2	2.4	30°
IN-C33BTOIR	840-850	A	450	500	1.6	1.8	60°
		B	500	550	1.8	2.0	60°
	850-860	C	550	600	2.0	2.2	60°
		D	600	650	2.2	2.4	60°
IN-C33ETOIR	840-850	A	450	500	1.6	1.8	90°
		B	500	550	1.8	2.0	90°
	850-860	C	550	600	2.0	2.2	90°
		D	600	650	2.2	2.4	90°
IN-C33CTOIR	840-850	A	450	500	1.6	1.8	120°
		B	500	550	1.8	2.0	120°
	850-860	C	550	600	2.0	2.2	120°
		D	600	650	2.2	2.4	120°

Note:

1. Forward voltage (V_F) $\pm 0.1V$, Radiometric Power (P_o) $\pm 10\%$.
2. Testing current of 5W is 1000mA

Label Specifications



Inolux P/N:

I	N	-	C	3	3		T	O		IR	-	X	X	X	X
Inolux SMD		Material	Package	Variation	Orientation	Current	Lens	Color		Customized Stamp-off					
		C = Ceramic Type	33A = 3.5 x 3.5, 30 Deg. 33B = 3.5 x 3.5, 60 Deg. 33C = 3.5 x 3.5, 120 Deg. 33E = 3.5 x 3.5, 90 Deg.	T = Top Mount	O = 1000mA	(Blank) = Clear	IR = 850nm								

Lot No.:

Z	2	0	1	7	01	24	001
Internal Tracker	Year (2017, 2018,)				Month	Date	Serial

Reflow Soldering

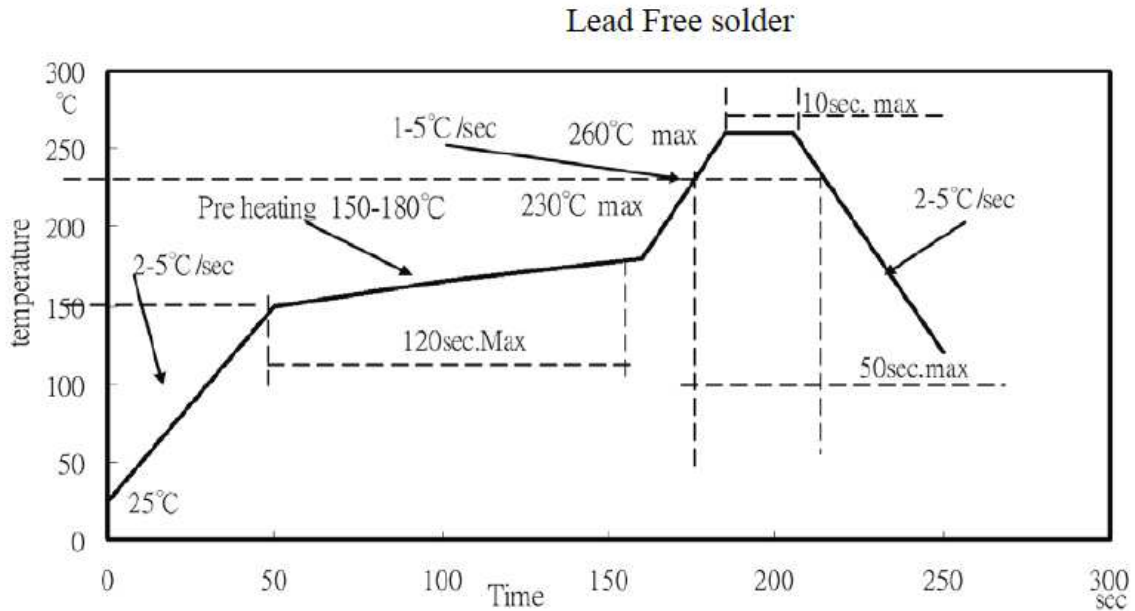

Soldering Iron

Basic Spec is ≤ 4 sec. when 260°C (+10°C → -1 second). Power dissipation of Iron should be less than 15W. Surface temperature should be under 230°C

Rework

Rework should be completed within 4 second under 245°C

Notes

1. Do not stress the silicone resin while it is exposed to high temperature.
2. The number of reflow process should not exceed 3 times.

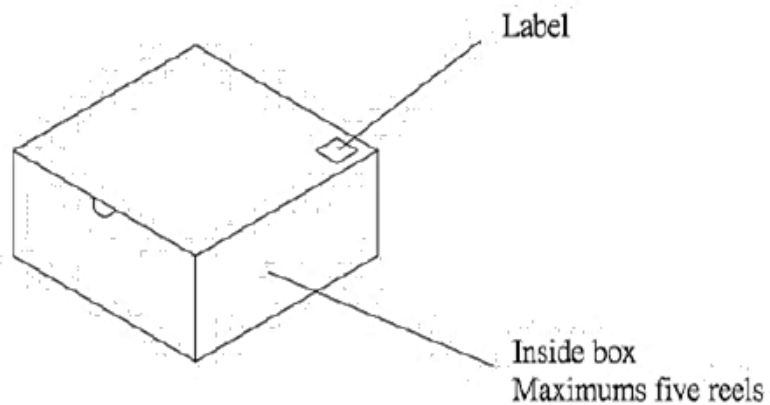
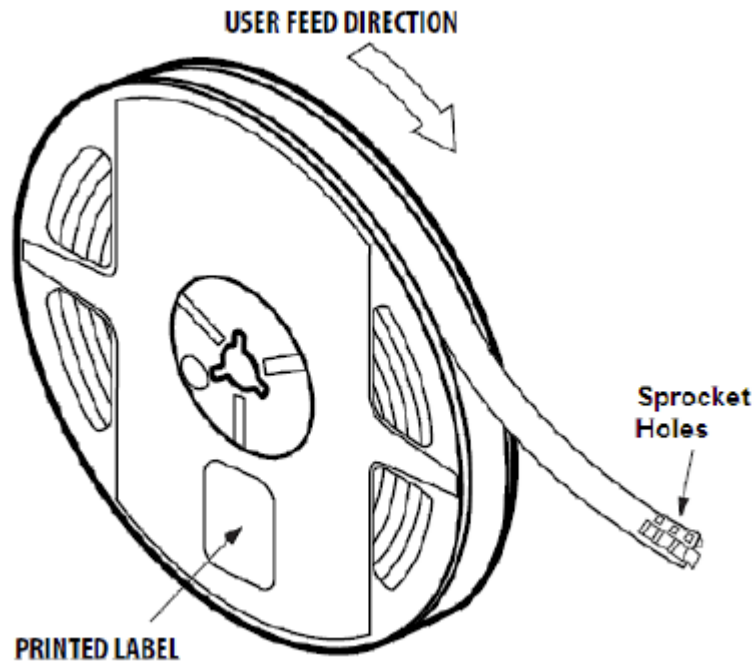
Notes:

1. Each Reel (minimum number of pieces is 100 and maximum is 500 (60D)/1000 (120D) is packed in a moisture-proof bag along with 2 packs of desiccant and a humidity indicator card;
2. A maximum of 5 moisture-proof bags are packed in an inner box (size: 240mm x 200mm x 105mm \pm 5mm)
3. A maximum of 4 inner boxes are put in an outer box (size: 410mm x 255mm x 230mm \pm 5mm)
4. Part No., Lot No., quantity should be indicated on the label of the moisture-proof bag and the cardboard box.

Precautions

1. Recommendation for using LEDs

1.1 The lens of LEDs should not be exposed to dust or debris. Excessive dust and debris may cause a drastic decrease in the luminosity.

1.2 Avoid mechanical stress on LED lens.

1.3 Do not touch the LED lens surface. It would affect the optical performance of the LED due to the LED lens' damage.

1.4 Pick & place tools are recommended for the remove of LEDs from the factory tape & reel packaging

2. Pick & place nozzle

The pickup tool was recommended and shown as below

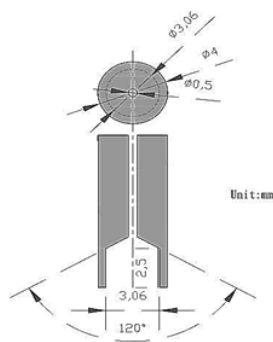

3. Lens handling

Please follow the guideline to pick LEDs

3.1 Use tweezers to pick LEDs

3.2 Do not touch the lens by using tweezers

3.3 Do not touch lens with fingers

3.4 Do not apply more than 4N of lens (400g) directly onto the lens

4. Lens cleaning

In the case which a small amount of dirt and dust particles remain on the lens surface, a suitable cleaning solution can be applied.

4.1 Try a gentle wiping with dust-free cloth

4.2 If needed, use dust-free cloth and isopropyl alcohol to gently clean the dirt from the lens surface.

4.3 Do not use other solvents as they may directly react with the LED assembly

4.4 Do not use ultrasonic cleaning which will damage the LEDs

Test Items and Results of Reliability

Test Item	Test Conditions	Duration/ Cycle	Number of Damage	Reference
Thermal Shock	-40°C 30min ↑↓5min 125°C 30min	100 cycles	0/22	AECQ101
High Temperature Storage	Ta=100°C	1000 hrs	0/22	EIAJ ED-4701 200 201
Humidity Heat Storage	Ta=85°C RH=85%	1000 hrs	0/22	EIAJ ED-4701 100 103
Low Temperature Storage	Ta=-40°C	1000 hrs	0/22	EIAJ ED-4701 200 202
Life Test	Ta=25°C If=700mA	1000 hrs	0/22	Tested with UVT standard
High Humidity Heat Life Test	85°C RH=85% If=700mA	1000 hrs	0/22	Tested with UVT standard
High Temperature Life Test	Ta=85°C	1000 hrs	0/22	Tested with UVT standard
ESD(HBM)	2KV at 1.5kΩ;100pf	3 Times	0/22	MIL-STD-883

Criteria for Judging the Damage				
Item	Symbol	Condition	Criteria for Judgment	
			Min	Max
Forward Voltage	VF	If=700mA	-	USL ¹ ×1.1
Reverse Current	IR	VR =5V	-	100μA
Luminous Intensity	Iv	If=700mA	LSL ² ×0.7	-

Notes:

1. USL: Upper specification level
2. LSL: Lower specification level

Revision History

Changes since last revision	Page	Version No.	Revision Date
Initial Release		1.0	04-16-2018
Format Adjustment		1.1	12-03-2018

DISCLAIMER

INOLUX reserves the right to make changes without further notice to any products herein to improve reliability, function or design. INOLUX does not assume any liability arising out of the application or use of any product or circuit described herein; neither does it convey any license under its patent rights, nor the rights of others.

LIFE SUPPORT POLICY

INOLUX's products are not authorized for use as critical components in life support devices or systems without the express written approval of the President of INOLUX or INOLUX CORPORATION. As used herein:

1. Life support devices or systems are devices or systems which, (a) are intended for surgical implant into the body, or (b) support or sustain life, and (c) whose failure to perform when properly used in accordance with instructions for use provided in the labeling, can be reasonably expected to result in a significant injury of the user.
2. A critical component in any component of a life support device or system whose failure to perform can be reasonably expected to cause the failure of the life support device or system, or to affect its safety or effectiveness.

Компания «Океан Электроники» предлагает заключение долгосрочных отношений при поставках импортных электронных компонентов на взаимовыгодных условиях!

Наши преимущества:

- Поставка оригинальных импортных электронных компонентов напрямую с производств Америки, Европы и Азии, а так же с крупнейших складов мира;
- Широкая линейка поставок активных и пассивных импортных электронных компонентов (более 30 млн. наименований);
- Поставка сложных, дефицитных, либо снятых с производства позиций;
- Оперативные сроки поставки под заказ (от 5 рабочих дней);
- Экспресс доставка в любую точку России;
- Помощь Конструкторского Отдела и консультации квалифицированных инженеров;
- Техническая поддержка проекта, помощь в подборе аналогов, поставка прототипов;
- Поставка электронных компонентов под контролем ВП;
- Система менеджмента качества сертифицирована по Международному стандарту ISO 9001;
- При необходимости вся продукция военного и аэрокосмического назначения проходит испытания и сертификацию в лаборатории (по согласованию с заказчиком);
- Поставка специализированных компонентов военного и аэрокосмического уровня качества (Xilinx, Altera, Analog Devices, Intersil, Interpoint, Microsemi, Actel, Aeroflex, Peregrine, VPT, Syfer, Eurofarad, Texas Instruments, MS Kennedy, Miteq, Cobham, E2V, MA-COM, Hittite, Mini-Circuits, General Dynamics и др.);

Компания «Океан Электроники» является официальным дистрибьютором и эксклюзивным представителем в России одного из крупнейших производителей разъемов военного и аэрокосмического назначения «JONHON», а так же официальным дистрибьютором и эксклюзивным представителем в России производителя высокотехнологичных и надежных решений для передачи СВЧ сигналов «FORSTAR».



JONHON

«JONHON» (основан в 1970 г.)

Разъемы специального, военного и аэрокосмического назначения:

(Применяются в военной, авиационной, аэрокосмической, морской, железнодорожной, горно- и нефтедобывающей отраслях промышленности)

«FORSTAR» (основан в 1998 г.)

ВЧ соединители, коаксиальные кабели, кабельные сборки и микроволновые компоненты:

(Применяются в телекоммуникациях гражданского и специального назначения, в средствах связи, РЛС, а так же военной, авиационной и аэрокосмической отраслях промышленности).



Телефон: 8 (812) 309-75-97 (многоканальный)

Факс: 8 (812) 320-03-32

Электронная почта: ocean@oceanchips.ru

Web: <http://oceanchips.ru/>

Адрес: 198099, г. Санкт-Петербург, ул. Калинина, д. 2, корп. 4, лит. А