

REV	DATE	BY	CHKD	APP'D	REASON
13	0024233	MCP	07SEF06	LG	CHECK
12	0018451	SAV	19 JAN 98	DGD	18 JAN 06
11	0018451	SAV	19 JAN 98	DGD	18 JAN 06
10	0018451	SAV	19 JAN 98	DGD	18 JAN 06
9	0018451	SAV	19 JAN 98	DGD	18 JAN 06
8	0018451	SAV	19 JAN 98	DGD	18 JAN 06
7	0018451	SAV	19 JAN 98	DGD	18 JAN 06
6	0018451	SAV	19 JAN 98	DGD	18 JAN 06
5	0018451	SAV	19 JAN 98	DGD	18 JAN 06
4	0018451	SAV	19 JAN 98	DGD	18 JAN 06
3	0018451	SAV	19 JAN 98	DGD	18 JAN 06

MICRO SWITCH
a Honeywell Division
SOLID STATE SENSOR
SS5 SERIES CHART 1

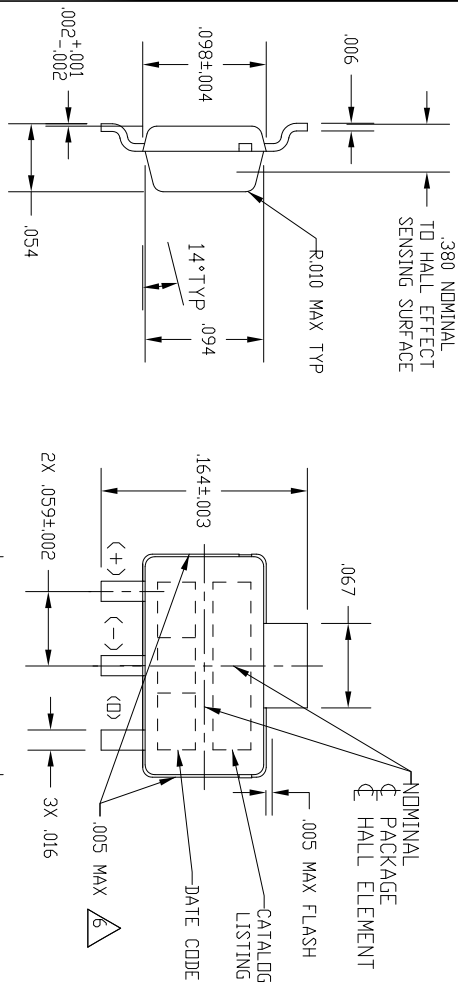

REV	DOCUMENT	CHANGED BY	CHECK
13	0024233	MCP 07SEF06	LG

NOTES
1 - SOLDERING INSTRUCTIONS: EXPOSURE TO HIGH TEMPERATURES SHOULD BE KEPT AT A MINIMUM MICRO SWITCH RECOMMENDS AN INFRARED REFLOW PROCESS WITH PEAK TEMPERATURES NOT EXCEEDING 245°C (473°F) FOR 10 SECONDS MAXIMUM. DO NOT WAVE SOLDER THIS PRODUCT AS THIS PROCESS MAY NEGATIVELY AFFECT THE SENSOR'S PERFORMANCE AND RELIABILITY. SUBJECTING THESE PRODUCTS TO WAVE SOLDERING WILL VOID MICRO SWITCH'S WARRANTY.
2 - ABSOLUTE MAXIMUM RATINGS ARE THE EXTREME LIMITS THE DEVICE WILL MOMENTARILY WITHSTAND WITHOUT DAMAGE TO THE DEVICE. ELECTRICAL AND MAGNETIC CHARACTERISTICS ARE NOT GUARANTEED IF THE SPECIFIED VOLTAGE AND/OR CURRENTS ARE EXCEEDED. NDR WILL THE DEVICE NECESSARILY OPERATE AT ABSOLUTE MAXIMUM RATING.
3 - THE MAGNETIC FLUX USED TO OPERATE THE SWITCH MUST BE IN THE DIRECTION AND LOCATION SHOWN. (THIS ASSUMES THE CONVENTION THAT THE DIRECTION OF THE EXTERNAL FLUX OF A MAGNET IS FROM THE NORTH TO THE SOUTH POLE OF THE MAGNET.)
4 - THE MAGNETIC FIELD STRENGTH (GAUSS) REQUIRED TO CAUSE THE SWITCH TO CHANGE STATE (OPERATE AND RELEASE) WILL BE AS SPECIFIED IN THE MAGNETIC CHARACTERISTICS. TO TEST THE SWITCH AGAINST THE SPECIFIED MAGNETIC CHARACTERISTICS, THE SWITCH MUST BE PLACED IN A UNIFORM MAGNETIC FIELD.
5 - A "T" SUFFIX ON ANY CATALOG LISTING DESIGNATES THE PRODUCT WILL BE SUPPLIED IN TAPE AND REEL FORM PER EIA STD 481. SS5 SERIES SHLD IN TAPE AND REEL ONLY. SOME BASIC LISTINGS MAY NOT BE AVAILABLE GATE VESAGE PERMITTED IN THESE AREAS. UNDERFLUSH BREAKOUT LIMITED TO .007.
6 - THESE HALL EFFECT SENSORS MAY HAVE AN INITIAL OUTPUT IN EITHER THE ON OR OFF STATE IF POWERED UP WITH AN APPLIED MAGNETIC FIELD IN THE DIFFERENTIAL ZONE (APPLIED MAGNETIC FIELD > BPP AND < BOP). MICRO SWITCH RECOMMENDS THAT THE APPLICATION CIRCUIT DESIGNER ALLOW 10 MICROSECONDS AFTER SUPPLY VOLTAGE HAS REACHED 5 VOLTS FOR THE OUTPUT VOLTAGE TO STABILIZE.

CONVERSION TO METRIC DIMENSIONS

DIMENSION	METRIC	DIMENSION	METRIC
IN INCHES	EQUIVALENT, MM	IN INCHES	EQUIVALENT, MM
.001	0.025	.095	2.413
.002	0.051	.098	2.489
.003	0.076	.157	3.988
.004	0.102	.164	4.166
.005	0.127	.173	4.394
.006	0.152	.177	4.496
.007	0.178	.181	4.597
.008	0.203	.197	5.004
.015	0.381	.217	5.512
.016	0.406	.230	5.842
.030	0.762	.314	7.976
.031	0.787	.315	8.001
.038	0.965	.472	11.989
.050	1.270	.480	12.192
.059	1.499	.512	13.005
.067	1.702	.724	18.390
.069	1.753	1.300	33.020
.078	1.981	1.970	50.038
.079	2.007	7.010	178.054
.094	2.388	10.000	254.000

THIRD ANGLE PROJECTION

DO NOT SCALE PRINT

SCALE NONE

UNLESS TOLERANCES SPECIFIED TOLERANCES ARE:

DNE PLACE (.00) +0.0 0.3

TWO PLACE (.00) +.015

THREE PLACE (.000) +.005

ANGLES

WEIGHT

MICRO SWITCH
a Honeywell Division
FED. REG. CODE 91929

SOLID STATE SENSOR

SS5 SERIES CHART 1

CATALOG LISTING

THIS DRAWING COVERS A PROPRIETARY ITEM AND IS THE PROPERTY OF MICRO SWITCH, A DIVISION OF HONEYWELL. THIS DRAWING IS NOT TO BE COPIED OR USED WITHOUT THE APPROVAL OF MICRO SWITCH.

CATALOG LISTING
SS5 SERIES CHART
PAGE 2 OF 5

ISSUE
14

PTC/CAD 3D
DRAWN
WJC 5 JAN 98
CHECK
SAV 19 JAN 98
CHECK
DGD 18 JAN 06
CHECK

REVISIONS
B REC'DWG
C 27 JAN 98
D 92729
E 92816
F 14 JAN 99
G 1 MAR 99
H 20747
I 20747
J 20814
K 20746
L 6 JAN 03
M 0019451
N 18 JAN 06

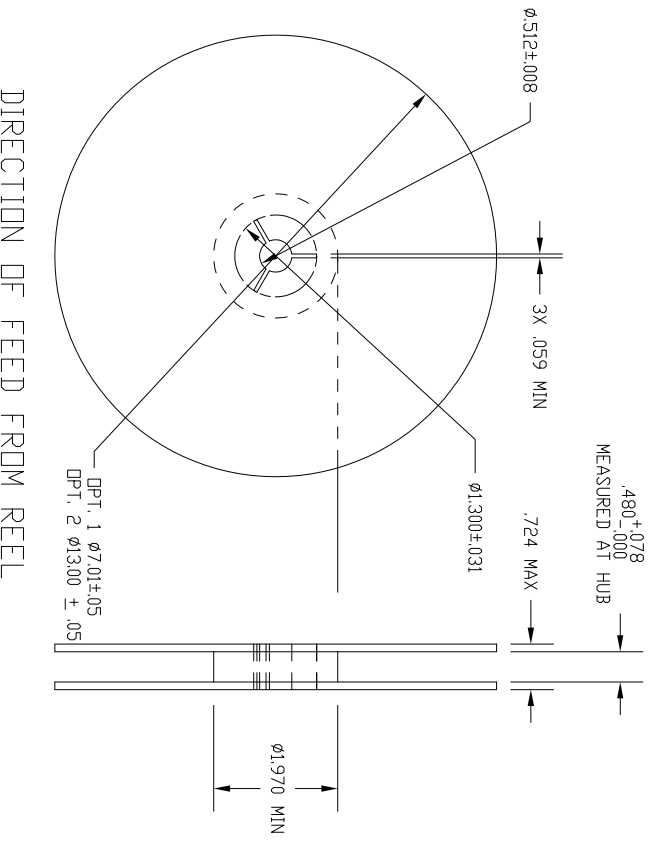
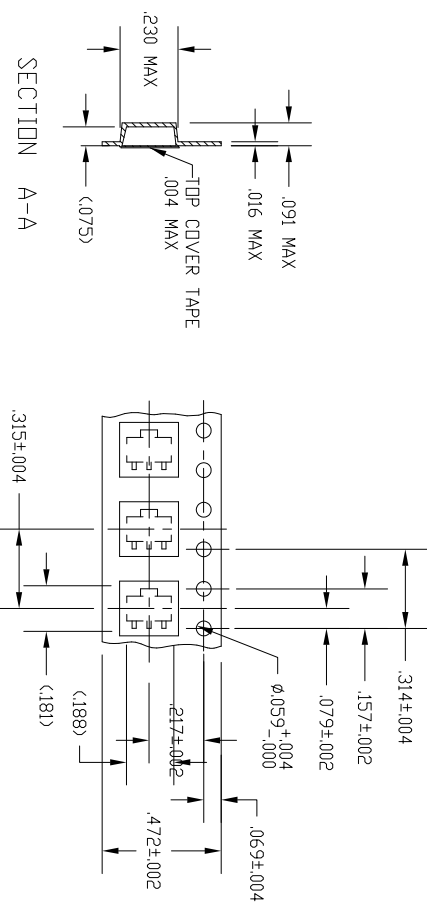

SS5 CATALOG SYSTEM

PREFIX
BASIC CATALOG LISTING:
PACKAGE STYLE, MAGNETIC TYPE,
ELECTRICAL/MAGNETIC SPECS

CHARACTERS IN THESE
POSITIONS OF THE LISTING
ARE BRANDED ON THE PRODUCT

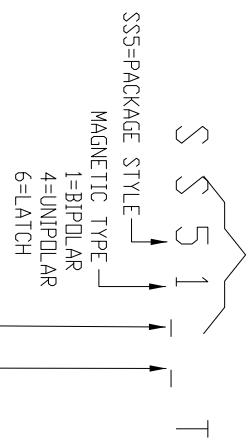

RELATIVE GAUSS OPERATING RANGE
(BLANK, 0-9, 9=HIGH GAUSS)
ELECTRICAL/MAGNETIC OPTIONS
(BLANK, A-K & U-Z)
A=STANDARD
B-K & U-Z=SPECIALS



THIRD ANGLE PROJECTION	
SCALE	NONE
DO NOT SCALE PRINT	
UNLESS TOLERANCES SPECIFIED	
TOLERANCES ARE:	
ONE PLACE	.00
TWO PLACE	+.00
THREE PLACE	+.000
ANGLES	±
WEIGHT	

ANSI Y14.5M-1982 APPLIES

TABLE 1 - MAGNETIC SPECIFICATIONS

LISTING	-40°C	0°C	25°C	85°C	125°C	150°C
MIN OPERATE GAUSS						
SS511	NS	NS	NS	NS	NS	NS
SS511AT	NS	NS	NS	NS	NS	NS
SS513AT	NS	NS	NS	NS	NS	NS
SS541AT	50	53	55	45	40	35
SS543AT	110	110	110	90	80	65
SS549AT	285	305	310	290	270	260
SS561AT	5	5	10	10	5	5
SS566AT	100	100	100	95	80	70
MAX OPERATE GAUSS						
SS511	145	145	140	150	200	250
SS511AT	70	65	60	60	65	70
SS513AT	140	140	140	140	140	140
SS541AT	135	117	115	120	123	125
SS543AT	215	190	180	180	190	200
SS549AT	435	400	390	400	410	420
SS561AT	110	90	85	85	100	110
SS566AT	200	185	180	180	180	185
MIN RELEASE GAUSS						
SS511	-145	-145	-140	-150	-200	-250
SS511AT	-70	-65	-60	-60	-65	-70
SS513AT	-140	-140	-140	-140	-140	-140
SS541AT	20	20	20	15	15	10
SS543AT	80	80	75	70	60	55
SS549AT	210	230	235	215	200	185
SS561AT	-110	-90	-85	-85	-100	-110
SS566AT	-200	-185	-180	-180	-180	-185
MAX RELEASE GAUSS						
SS511	NS	NS	NS	NS	NS	NS
SS511AT	NS	NS	NS	NS	NS	NS
SS513AT	NS	NS	NS	NS	NS	NS
SS541AT	120	99	95	105	115	120
SS543AT	190	165	155	165	180	195
SS549AT	360	325	315	325	340	345
SS561AT	-5	-5	-10	-10	-5	-5
SS566AT	-100	-100	-100	-95	-80	-70
MIN DIFF GAUSS						
SS511	40	50	50	60	60	NS
SS511AT	15	15	15	12	12	10
SS513AT	20	20	20	20	20	20
SS541AT	15	15	20	15	8	5
SS543AT	25	25	25	15	10	5
SS549AT	30	30	30	30	30	30
SS561AT	50	50	50	50	50	50
SS566AT	200	200	200	190	160	140

SS5XT ELECTRICAL SPECIFICATIONS

CHARACTERISTIC	TEST CONDITIONS	UNITS
VOLTAGE RANGE	VCC = 24V, -40°C < T < 150°C, B > MAX DP	4.5 TO 24 VOLTS
MAX I _{on}	VCC = 24V, V _{out} = 24V, -40°C < T < 150°C, B < MIN REL	100 mA
MAX I _{off}	VCC = 24V, V _{out} = 24V, -40°C < T < 150°C, B < MIN REL	11.3 mA
SINK CURRENT	VCC = 45V TO 24V, T = 25°C, B > MAX DP	20 mA
MAX V _{sat}	VCC = 45V TO 24V, T = 25°C, B > MAX DP	0.4 VOLTS
MAX LEAKAGE	VCC = 12V, R	10 μA
RISE TIME	VCC = 12V, R	1.5 μS
FALL TIME	10% TO 90%	1.5 μS
90% TO 10%	V _{ds} = 12V, R	Ω = 20pF

ABSOLUTE MAXIMUM RATINGS

TEMPERATURE	-40°C TO +150°C
SUPPLY VOLTAGE	-28 VDC TO 28 VDC
VOLTAGE EXTERNALLY APPLIED TO OUTPUT	280 VDC MAX WITH SWITCH IN OFF COND. ONLY -0.5 VDC WITH SWITCH IN DN DR OFF COND.
OUTPUT CURRENT	20 mA
MAGNETIC FLUX	NO LIMIT

SS5XXAT ELECTRICAL SPECIFICATIONS

CHARACTERISTIC	TEST CONDITIONS	UNITS
VOLTAGE RANGE	VCC = 30V, -40°C < T < 150°C, B > MAX DP	3.8 TO 30 VOLTS
MAX I _{on}	VCC = 30V, V _{out} = 30V, -40°C < T < 150°C, B < MIN REL	100 mA
MAX I _{off}	VCC = 30V, V _{out} = 30V, -40°C < T < 150°C, B < MIN REL	10.0 mA
SINK CURRENT	VCC = 38V, B > MAX DP	20 mA
MAX LEAKAGE	VCC = 12V, R	10 μA
RISE TIME	VCC = 12V, R	1.5 μS
FALL TIME	10% TO 90%	1.5 μS
90% TO 10%	V _{ds} = 12V, R	Ω = 20pF

ABSOLUTE MAXIMUM RATING

CHARACTERISTIC	SYMBOL	MIN	MAX	UNITS
POWER SUPPLY	VCC	-1	30	VOLTS
OUTPUT VOLTAGE (DIF)	V _{OUT}		SEE TABLE	VOLTS
OUTPUT ON CURRENT	I _{ON}		SEE TABLE	mA
OPERATING TEMPERATURE	T	-50	60	°C
STORAGE TEMPERATURE	T _S	-65	160	°C
MAGNETIC FLUX	NO LIMIT			

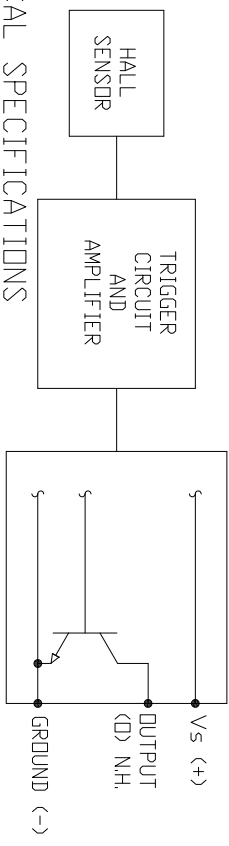
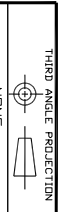

TABLE 2

SS5XX	OUTPUT CURRENT	ABSOLUTE LIMITS
-1 TO 24	50	
24 TO 25	37	
25 TO 26	33	
26 TO 27	28	
27 TO 28	24	
28 TO 29	19	
29 TO 30	15	



THIRD ANGLE PROJECTION
SCALE NONE
DO NOT SCALE PRINT
UNLESS OTHERWISE SPECIFIED
DIMENSIONS ARE
ONE PLACE (.0) +0.03
TWO PLACE (.00) +0.05
THREE PLACE (.000) +0.05
WEIGHT

MICRO SWITCH
a Honeywell Division
FED. REG. CODE 91929

SOLID STATE SENSOR

SS5 SERIES CHART 1

CATALOG LISTING

THIS DRAWING COVERS A PROPRIETARY ITEM AND IS THE PROPERTY OF MICRO SWITCH, A DIVISION OF HONEYWELL. THIS DRAWING IS NOT TO BE COPIED OR USED WITHOUT THE APPROVAL OF MICRO SWITCH.

CATALOG LISTING
SS5 SERIES CHART
PAGE 4 OF 5

ISSUE
14

REVISIONS
A. REV. Dwg. 27 JUN 98
B. REV. Dwg. 18 JAN 96
C. REV. Dwg. 18 JAN 96
D. REV. Dwg. 18 JAN 96
E. REV. Dwg. 18 JAN 96
F. REV. Dwg. 18 JAN 96
G. REV. Dwg. 18 JAN 96
H. REV. Dwg. 18 JAN 96

DRAWN: WJC 5 JAN 98
CHECK: SAV 19 JAN 98
CHECK: DGD 18 JAN 06
CHECK: []
RELEASE NO. DR-4996
REPLACES: -

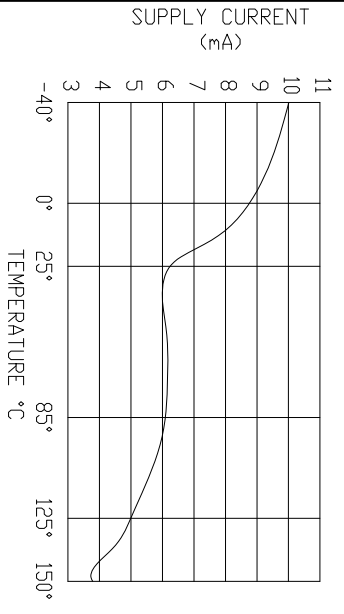

MAXIMUM SUPPLY CURRENT (OFF)

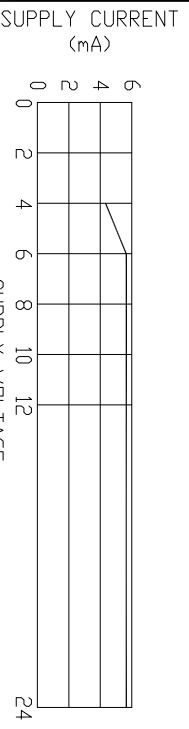

TYPICAL SUPPLY CURRENT (DEVICE OFF) AT 25°C

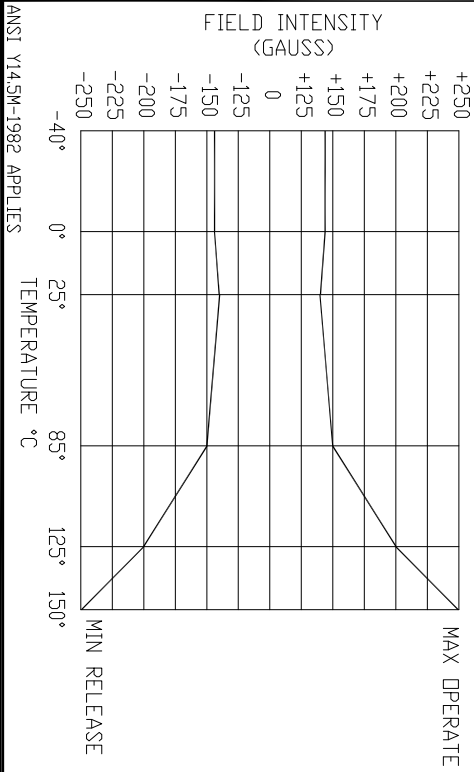

ANSI Y14.5M-1982 APPLIES

SSS11AT

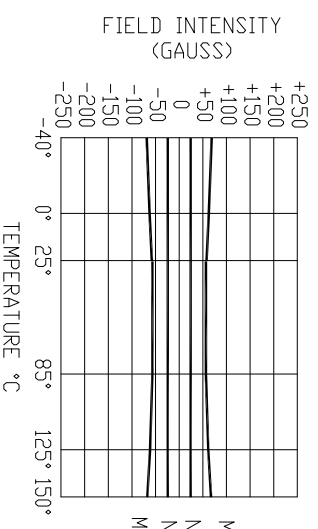

MAX OPERATE
NDM OPERATE
NDM RELEASE
MIN RELEASE

SSS13AT

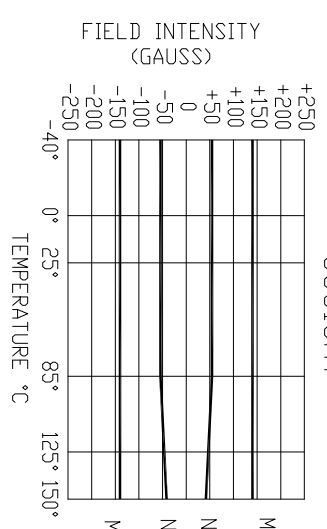

MAX OPERATE
NDM OPERATE
NDM RELEASE
MIN RELEASE



THIRD ANGLE PROJECTION
SCALE: NONE
DO NOT SCALE PRINT

UNLESS TOLERANCES SPECIFIED
TOLERANCES ARE:
ONE PLACE (.00) +0.03
TWO PLACE (.000) +0.015
THREE PLACE (.0000) +0.005
ANGLES ±
WEIGHT

WJC	5 JAN 98	CHECK	SAV	19 JAN 02	CHECK	DGD	18 JAN 06	CHECK	RELEASE NO.	DR-4996	REPLACES	-
-----	----------	-------	-----	-----------	-------	-----	-----------	-------	-------------	---------	----------	---

MICRO SWITCH
a Honeywell Division
FED. MFG. CODE 91929

SOLID STATE SENSOR

CATALOG LISTING
SS5 SERIES CHART 1

THIS DRAWING COVERS A PROPRIETARY ITEM AND IS THE PROPERTY OF MICRO SWITCH, A DIVISION OF HONEYWELL. THIS DRAWING IS NOT TO BE COPIED OR USED WITHOUT THE APPROVAL OF MICRO SWITCH.

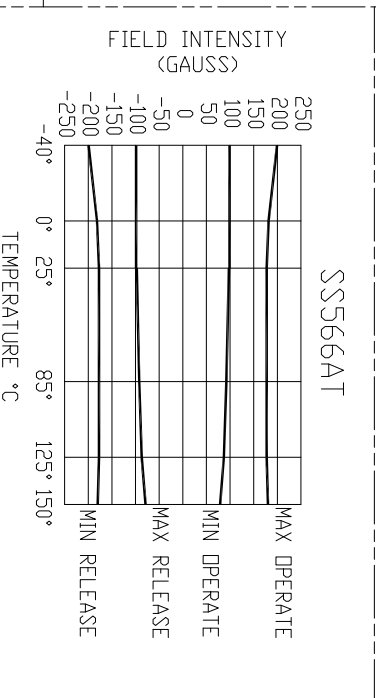
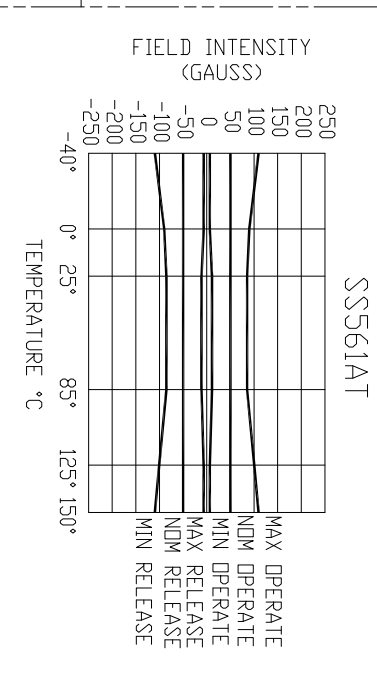
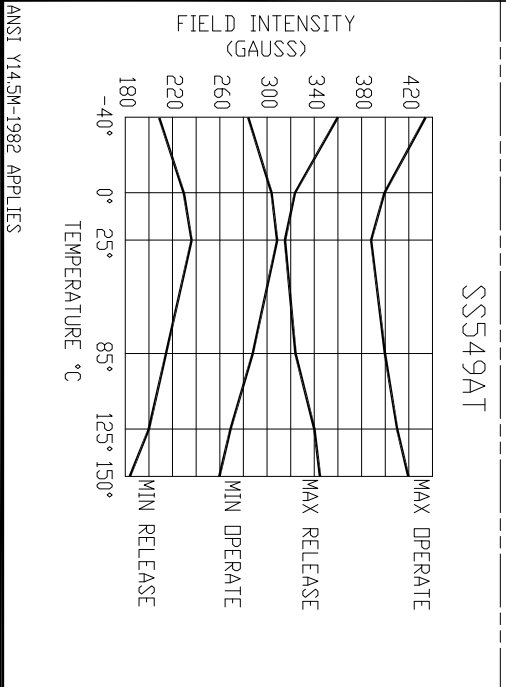
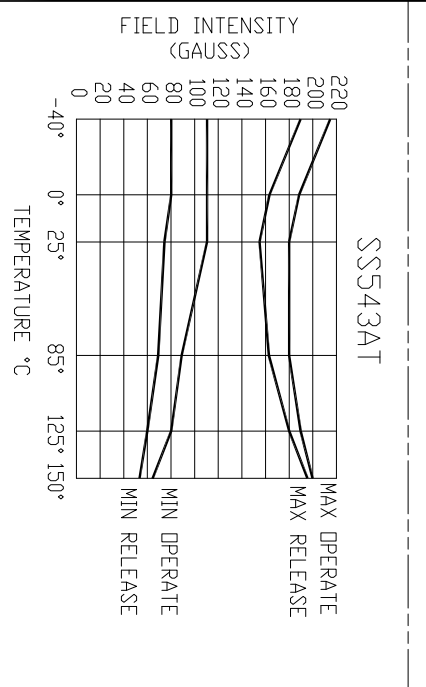
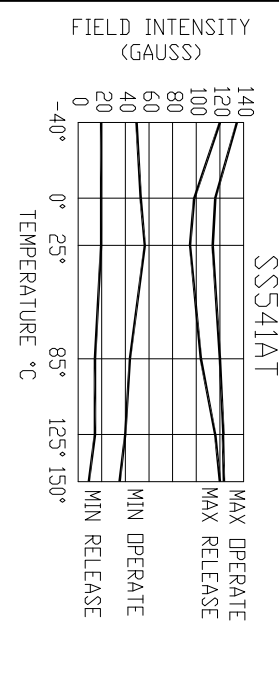

REVISIONS	A	REL. DWG.	27 JUN 98
	B	REV. 1	18 JAN 06
	C	REV. 2	18 JAN 06
	D	REV. 3	18 JAN 06
	E	REV. 4	18 JAN 06
	F	REV. 5	18 JAN 06
	G	REV. 6	18 JAN 06
	H	REV. 7	18 JAN 06
	I	REV. 8	18 JAN 06
	J	REV. 9	18 JAN 06
	K	REV. 10	18 JAN 06
	L	REV. 11	18 JAN 06
	M	REV. 12	18 JAN 06
	N	REV. 13	18 JAN 06
	O	REV. 14	18 JAN 06
	P	REV. 15	18 JAN 06
	Q	REV. 16	18 JAN 06
	R	REV. 17	18 JAN 06
	S	REV. 18	18 JAN 06
	T	REV. 19	18 JAN 06
	U	REV. 20	18 JAN 06
	V	REV. 21	18 JAN 06
	W	REV. 22	18 JAN 06
	X	REV. 23	18 JAN 06
	Y	REV. 24	18 JAN 06
	Z	REV. 25	18 JAN 06

ANSI Y14.5M-1982 APPLIES



THIRD ANGLE PROJECTION	
SCALE	NONE
DO NOT SCALE PRINT	
UNLESS TOLERANCES SPECIFIED	
ONE PLACE	(.0)
TWO PLACE	(.00)
THREE PLACE	(.000)
ANGLES	(.000) +.005
WEIGHT	

Компания «Океан Электроники» предлагает заключение долгосрочных отношений при поставках импортных электронных компонентов на взаимовыгодных условиях!

Наши преимущества:

- Поставка оригинальных импортных электронных компонентов напрямую с производств Америки, Европы и Азии, а так же с крупнейших складов мира;
- Широкая линейка поставок активных и пассивных импортных электронных компонентов (более 30 млн. наименований);
- Поставка сложных, дефицитных, либо снятых с производства позиций;
- Оперативные сроки поставки под заказ (от 5 рабочих дней);
- Экспресс доставка в любую точку России;
- Помощь Конструкторского Отдела и консультации квалифицированных инженеров;
- Техническая поддержка проекта, помощь в подборе аналогов, поставка прототипов;
- Поставка электронных компонентов под контролем ВП;
- Система менеджмента качества сертифицирована по Международному стандарту ISO 9001;
- При необходимости вся продукция военного и аэрокосмического назначения проходит испытания и сертификацию в лаборатории (по согласованию с заказчиком);
- Поставка специализированных компонентов военного и аэрокосмического уровня качества (Xilinx, Altera, Analog Devices, Intersil, Interpoint, Microsemi, Actel, Aeroflex, Peregrine, VPT, Syfer, Eurofarad, Texas Instruments, MS Kennedy, Miteq, Cobham, E2V, MA-COM, Hittite, Mini-Circuits, General Dynamics и др.);

Компания «Океан Электроники» является официальным дистрибьютором и эксклюзивным представителем в России одного из крупнейших производителей разъемов военного и аэрокосмического назначения «JONHON», а так же официальным дистрибьютором и эксклюзивным представителем в России производителя высокотехнологичных и надежных решений для передачи СВЧ сигналов «FORSTAR».



JONHON

«JONHON» (основан в 1970 г.)

Разъемы специального, военного и аэрокосмического назначения:

(Применяются в военной, авиационной, аэрокосмической, морской, железнодорожной, горно- и нефтедобывающей отраслях промышленности)

«FORSTAR» (основан в 1998 г.)

ВЧ соединители, коаксиальные кабели, кабельные сборки и микроволновые компоненты:

(Применяются в телекоммуникациях гражданского и специального назначения, в средствах связи, РЛС, а так же военной, авиационной и аэрокосмической отраслях промышленности).



Телефон: 8 (812) 309-75-97 (многоканальный)

Факс: 8 (812) 320-03-32

Электронная почта: ocean@oceanchips.ru

Web: <http://oceanchips.ru/>

Адрес: 198099, г. Санкт-Петербург, ул. Калинина, д. 2, корп. 4, лит. А