



A Microchip Technology Company

Not recommended for new designs. Please use SST39VF1601C and SST39VF3201B.

16 Mbit / 32 Mbit / (x16) Multi-Purpose Flash Plus

SST39VF1601 / SST39VF3201

SST39VF1602 / SST39VF3202

Not Recommended for New Designs

The SST39VF1601/1602 and SST39VF3201/3202 devices are 1M x16 and 2M x16, respectively, CMOS Multi-Purpose Flash Plus (MPF+) manufactured with SST's proprietary, high performance CMOS SuperFlash technology. The split-gate cell design and thick-oxide tunneling injector attain better reliability and manufacturability compared with alternate approaches. The SST39VF1601/1602/3201/3202 write (Program or Erase) with a 2.7-3.6V power supply. These devices conform to JEDEC standard pinouts for x16 memories.

Features

- **Organized as 1M x16: SST39VF1601/1602**
2M x16: SST39VF3201/3202
- **Single Voltage Read and Write Operations**
 - 2.7-3.6V
- **Superior Reliability**
 - Endurance: 100,000 Cycles (Typical)
 - Greater than 100 years Data Retention
- **Low Power Consumption (typical values at 5 MHz)**
 - Active Current: 9 mA (typical)
 - Standby Current: 3 μ A (typical)
 - Auto Low Power Mode: 3 μ A (typical)
- **Hardware Block-Protection/WP# Input Pin**
 - Top Block-Protection (top 32 KWord) for SST39VF1602/3202
 - Bottom Block-Protection (bottom 32 KWord) for SST39VF1601/3201
- **Sector-Erase Capability**
 - Uniform 2 KWord sectors
- **Block-Erase Capability**
 - Uniform 32 KWord blocks
- **Chip-Erase Capability**
- **Erase-Suspend/Erase-Resume Capabilities**
- **Hardware Reset Pin (RST#)**
- **Security-ID Feature**
 - SST: 128 bits; User: 128 bits
- **Fast Read Access Time:**
 - 70 ns
- **Latched Address and Data**
- **Fast Erase and Word-Program:**
 - Sector-Erase Time: 18 ms (typical)
 - Block-Erase Time: 18 ms (typical)
 - Chip-Erase Time: 40 ms (typical)
 - Word-Program Time: 7 μ s (typical)
- **Automatic Write Timing**
 - Internal V_{PP} Generation
- **End-of-Write Detection**
 - Toggle Bits
 - Data# Polling
- **CMOS I/O Compatibility**
- **JEDEC Standard**
 - Flash EEPROM Pinouts and command sets
- **Packages Available**
 - 48-lead TSOP (12mm x 20mm)
 - 48-ball TFBGA (6mm x 8mm)
- **All devices are RoHS compliant**



A Microchip Technology Company

16 Mbit / 32 Mbit Multi-Purpose Flash Plus

SST39VF1601 / SST39VF3201

SST39VF1602 / SST39VF3202

Not Recommended for New Designs

Product Description

The SST39VF160x and SST39VF320x devices are 1M x16 and 2M x16, respectively, CMOS Multi-Purpose Flash Plus (MPF+) manufactured with SST's proprietary, high performance CMOS SuperFlash technology. The split-gate cell design and thick-oxide tunneling injector attain better reliability and manufacturability compared with alternate approaches. The SST39VF160x/320x write (Program or Erase) with a 2.7-3.6V power supply. These devices conform to JEDEC standard pinouts for x16 memories.

Featuring high performance Word-Program, the SST39VF160x/320x devices provide a typical Word-Program time of 7 μ sec. These devices use Toggle Bit or Data# Polling to indicate the completion of Program operation. To protect against inadvertent write, they have on-chip hardware and Software Data Protection schemes. Designed, manufactured, and tested for a wide spectrum of applications, these devices are offered with a guaranteed typical endurance of 100,000 cycles. Data retention is rated at greater than 100 years.

The SST39VF160x/320x devices are suited for applications that require convenient and economical updating of program, configuration, or data memory. For all system applications, they significantly improve performance and reliability, while lowering power consumption. They inherently use less energy during Erase and Program than alternative flash technologies. The total energy consumed is a function of the applied voltage, current, and time of application. Since for any given voltage range, the SuperFlash technology uses less current to program and has a shorter erase time, the total energy consumed during any Erase or Program operation is less than alternative flash technologies. These devices also improve flexibility while lowering the cost for program, data, and configuration storage applications.

The SuperFlash technology provides fixed Erase and Program times, independent of the number of Erase/Program cycles that have occurred. Therefore the system software or hardware does not have to be modified or de-rated as is necessary with alternative flash technologies, whose Erase and Program times increase with accumulated Erase/Program cycles.

To meet high density, surface mount requirements, the SST39VF160x/320x are offered in 48-lead TSOP and 48-ball TFBGA packages. See Figures 2 and 3 for pin assignments.



16 Mbit / 32 Mbit Multi-Purpose Flash Plus

SST39VF1601 / SST39VF3201

SST39VF1602 / SST39VF3202

Not Recommended for New Designs

Block Diagram



Figure 1: Functional Block Diagram



16 Mbit / 32 Mbit Multi-Purpose Flash Plus

SST39VF1601 / SST39VF3201
SST39VF1602 / SST39VF3202

Not Recommended for New Designs

Pin Assignment



Figure 2: Pin Assignments for 48-lead TSOP



Figure 3: pin assignments for 48-ball TFBGA



16 Mbit / 32 Mbit Multi-Purpose Flash Plus

SST39VF1601 / SST39VF3201 SST39VF1602 / SST39VF3202

Not Recommended for New Designs

Table 1: Pin Description

Symbol	Pin Name	Functions
$A_{MS}^1-A_0$	Address Inputs	To provide memory addresses. During Sector-Erase $A_{MS}-A_{11}$ address lines will select the sector. During Block-Erase $A_{MS}-A_{15}$ address lines will select the block.
$DQ_{15}-DQ_0$	Data Input/output	To output data during Read cycles and receive input data during Write cycles. Data is internally latched during a Write cycle. The outputs are in tri-state when OE# or CE# is high.
WP#	Write Protect	To protect the top/bottom boot block from Erase/Program operation when grounded.
RST#	Reset	To reset and return the device to Read mode.
CE#	Chip Enable	To activate the device when CE# is low.
OE#	Output Enable	To gate the data output buffers.
WE#	Write Enable	To control the Write operations.
V_{DD}	Power Supply	To provide power supply voltage: 2.7-3.6V
V_{SS}	Ground	
NC	No Connection	Unconnected pins.

T1.2 25028

1. A_{MS} = Most significant address
 $A_{MS} = A_{19}$ for SST39VF1601/1602, and A_{20} for SST39VF3201/3202



Device Operation

Commands are used to initiate the memory operation functions of the device. Commands are written to the device using standard microprocessor write sequences. A command is written by asserting WE# low while keeping CE# low. The address bus is latched on the falling edge of WE# or CE#, whichever occurs last. The data bus is latched on the rising edge of WE# or CE#, whichever occurs first.

The SST39VF160x/320x also have the **Auto Low Power** mode which puts the device in a near standby mode after data has been accessed with a valid Read operation. This reduces the I_{DD} active read current from typically 9 mA to typically 3 μ A. The Auto Low Power mode reduces the typical I_{DD} active read current to the range of 2 mA/MHz of Read cycle time. The device exits the Auto Low Power mode with any address transition or control signal transition used to initiate another Read cycle, with no access time penalty. Note that the device does not enter Auto-Low Power mode after power-up with CE# held steadily low, until the first address transition or CE# is driven high.

Read

The Read operation of the SST39VF160x/320x is controlled by CE# and OE#, both have to be low for the system to obtain data from the outputs. CE# is used for device selection. When CE# is high, the chip is deselected and only standby power is consumed. OE# is the output control and is used to gate data from the output pins. The data bus is in high impedance state when either CE# or OE# is high. Refer to the Read cycle timing diagram for further details (Figure 4).

Word-Program Operation

The SST39VF160x/320x are programmed on a word-by-word basis. Before programming, the sector where the word exists must be fully erased. The Program operation is accomplished in three steps. The first step is the three-byte load sequence for Software Data Protection. The second step is to load word address and word data. During the Word-Program operation, the addresses are latched on the falling edge of either CE# or WE#, whichever occurs last. The data is latched on the rising edge of either CE# or WE#, whichever occurs first. The third step is the internal Program operation which is initiated after the rising edge of the fourth WE# or CE#, whichever occurs first. The Program operation, once initiated, will be completed within 10 μ s. See Figures 5 and 6 for WE# and CE# controlled Program operation timing diagrams and Figure 20 for flowcharts. During the Program operation, the only valid reads are Data# Polling and Toggle Bit. During the internal Program operation, the host is free to perform additional tasks. Any commands issued during the internal Program operation are ignored. During the command sequence, WP# should be statically held high or low.

Sector/Block-Erase Operation

The Sector- (or Block-) Erase operation allows the system to erase the device on a sector-by-sector (or block-by-block) basis. The SST39VF160x/320x offer both Sector-Erase and Block-Erase mode. The sector architecture is based on uniform sector size of 2 KWord. The Block-Erase mode is based on uniform block size of 32 KWord. The Sector-Erase operation is initiated by executing a six-byte command sequence with Sector-Erase command (30H) and sector address (SA) in the last bus cycle. The Block-Erase operation is initiated by executing a six-byte command sequence with Block-Erase command (50H) and block address (BA) in the last bus cycle. The sector or block address is latched on the falling edge of the sixth WE# pulse, while the command (30H or 50H) is latched on the rising edge of the sixth WE# pulse. The internal Erase operation begins after the sixth WE# pulse. The End-of-Erase operation can be determined using either Data# Polling or Toggle Bit methods. See Figures 10 and 11



Not Recommended for New Designs

for timing waveforms and Figure 24 for the flowchart. Any commands issued during the Sector- or Block-Erase operation are ignored. When WP# is low, any attempt to Sector- (Block-) Erase the protected block will be ignored. During the command sequence, WP# should be statically held high or low.

Erase-Suspend/Erase-Resume Commands

The Erase-Suspend operation temporarily suspends a Sector- or Block-Erase operation thus allowing data to be read from any memory location, or program data into any sector/block that is not suspended for an Erase operation. The operation is executed by issuing one byte command sequence with Erase-Suspend command (B0H). The device automatically enters read mode typically within 20 μ s after the Erase-Suspend command had been issued. Valid data can be read from any sector or block that is not suspended from an Erase operation. Reading at address location within erase-suspended sectors/blocks will output DQ₂ toggling and DQ₆ at "1". While in Erase-Suspend mode, a Word-Program operation is allowed except for the sector or block selected for Erase-Suspend.

To resume Sector-Erase or Block-Erase operation which has been suspended the system must issue Erase Resume command. The operation is executed by issuing one byte command sequence with Erase Resume command (30H) at any address in the last Byte sequence.

Chip-Erase Operation

The SST39VF160x/320x provide a Chip-Erase operation, which allows the user to erase the entire memory array to the "1" state. This is useful when the entire device must be quickly erased.

The Chip-Erase operation is initiated by executing a six-byte command sequence with Chip-Erase command (10H) at address 5555H in the last byte sequence. The Erase operation begins with the rising edge of the sixth WE# or CE#, whichever occurs first. During the Erase operation, the only valid read is Toggle Bit or Data# Polling. See Table 6 for the command sequence, Figure 10 for timing diagram, and Figure 24 for the flowchart. Any commands issued during the Chip-Erase operation are ignored. When WP# is low, any attempt to Chip-Erase will be ignored. During the command sequence, WP# should be statically held high or low.

Write Operation Status Detection

The SST39VF160x/320x provide two software means to detect the completion of a Write (Program or Erase) cycle, in order to optimize the system write cycle time. The software detection includes two status bits: Data# Polling (DQ₇) and Toggle Bit (DQ₆). The End-of-Write detection mode is enabled after the rising edge of WE#, which initiates the internal Program or Erase operation.

The actual completion of the nonvolatile write is asynchronous with the system; therefore, either a Data# Polling or Toggle Bit read may be simultaneous with the completion of the write cycle. If this occurs, the system may possibly get an erroneous result, i.e., valid data may appear to conflict with either DQ₇ or DQ₆. In order to prevent spurious rejection, if an erroneous result occurs, the software routine should include a loop to read the accessed location an additional two (2) times. If both reads are valid, then the device has completed the Write cycle, otherwise the rejection is valid.



Not Recommended for New Designs

Data# Polling (DQ₇)

When the SST39VF160x/320x are in the internal Program operation, any attempt to read DQ₇ will produce the complement of the true data. Once the Program operation is completed, DQ₇ will produce true data. Note that even though DQ₇ may have valid data immediately following the completion of an internal Write operation, the remaining data outputs may still be invalid: valid data on the entire data bus will appear in subsequent successive Read cycles after an interval of 1 μ s. During internal Erase operation, any attempt to read DQ₇ will produce a '0'. Once the internal Erase operation is completed, DQ₇ will produce a '1'. The Data# Polling is valid after the rising edge of fourth WE# (or CE#) pulse for Program operation. For Sector-, Block- or Chip-Erase, the Data# Polling is valid after the rising edge of sixth WE# (or CE#) pulse. See Figure 7 for Data# Polling timing diagram and Figure 21 for a flowchart.

Toggle Bits (DQ₆ and DQ₂)

During the internal Program or Erase operation, any consecutive attempts to read DQ₆ will produce alternating "1"s and "0"s, i.e., toggling between 1 and 0. When the internal Program or Erase operation is completed, the DQ₆ bit will stop toggling. The device is then ready for the next operation. For Sector-, Block-, or Chip-Erase, the toggle bit (DQ₆) is valid after the rising edge of sixth WE# (or CE#) pulse. DQ₆ will be set to "1" if a Read operation is attempted on an Erase-Suspended Sector/Block. If Program operation is initiated in a sector/block not selected in Erase-Suspend mode, DQ₆ will toggle.

An additional Toggle Bit is available on DQ₂, which can be used in conjunction with DQ₆ to check whether a particular sector is being actively erased or erase-suspended. Table 2 shows detailed status bits information. The Toggle Bit (DQ₂) is valid after the rising edge of the last WE# (or CE#) pulse of Write operation. See Figure 8 for Toggle Bit timing diagram and Figure 21 for a flowchart.

Table 2: Write Operation Status

Status		DQ ₇	DQ ₆	DQ ₂
Normal Operation	Standard Program	DQ ₇ #	Toggle	No Toggle
	Standard Erase	0	Toggle	Toggle
Erase-Suspend Mode	Read from Erase-Suspended Sector/Block	1	1	Toggle
	Read from Non- Erase-Suspended Sector/Block	Data	Data	Data
	Program	DQ ₇ #	Toggle	N/A

T2.0 25028

Note: DQ₇ and DQ₂ require a valid address when reading status information.

Data Protection

The SST39VF160x/320x provide both hardware and software features to protect nonvolatile data from inadvertent writes.

Hardware Data Protection

Noise/Glitch Protection: A WE# or CE# pulse of less than 5 ns will not initiate a write cycle.

V_{DD} Power Up/Down Detection: The Write operation is inhibited when V_{DD} is less than 1.5V.

Write Inhibit Mode: Forcing OE# low, CE# high, or WE# high will inhibit the Write operation. This prevents inadvertent writes during power-up or power-down.



Hardware Block Protection

The SST39VF1602/3202 support top hardware block protection, which protects the top 32 KWord block of the device. The SST39VF1601/3201 support bottom hardware block protection, which protects the bottom 32 KWord block of the device. The Boot Block address ranges are described in Table 3. Program and Erase operations are prevented on the 32 KWord when WP# is low. If WP# is left floating, it is internally held high via a pull-up resistor, and the Boot Block is unprotected, enabling Program and Erase operations on that block.

Table 3: Boot Block Address Ranges

Product	Address Range
Bottom Boot Block SST39VF1601/3201	000000H-007FFFH
Top Boot Block SST39VF1602	0F8000H-0FFFFFFH
SST39VF3202	1F8000H-1FFFFFFH

T3.0 25028

Hardware Reset (RST#)

The RST# pin provides a hardware method of resetting the device to read array data. When the RST# pin is held low for at least T_{RP} , any in-progress operation will terminate and return to Read mode. When no internal Program/Erase operation is in progress, a minimum period of T_{RHR} is required after RST# is driven high before a valid Read can take place (see Figure 16).

The Erase or Program operation that has been interrupted needs to be reinitiated after the device resumes normal operation mode to ensure data integrity.

Software Data Protection (SDP)

The SST39VF160x/320x provide the JEDEC approved Software Data Protection scheme for all data alteration operations, i.e., Program and Erase. Any Program operation requires the inclusion of the three-byte sequence. The three-byte load sequence is used to initiate the Program operation, providing optimal protection from inadvertent Write operations, e.g., during the system power-up or power-down. Any Erase operation requires the inclusion of six-byte sequence. These devices are shipped with the Software Data Protection permanently enabled. See Table 6 for the specific software command codes. During SDP command sequence, invalid commands will abort the device to read mode within T_{RC} . The contents of DQ₁₅-DQ₈ can be V_{IL} or V_{IH} , but no other value, during any SDP command sequence.

Common Flash Memory Interface (CFI)

The SST39VF160x/320x also contain the CFI information to describe the characteristics of the device. In order to enter the CFI Query mode, the system must write three-byte sequence, same as product ID entry command with 98H (CFI Query command) to address 5555H in the last byte sequence. Once the device enters the CFI Query mode, the system can read CFI data at the addresses given in Tables 7 through 10. The system must write the CFI Exit command to return to Read mode from the CFI Query mode.



16 Mbit / 32 Mbit Multi-Purpose Flash Plus

SST39VF1601 / SST39VF3201 SST39VF1602 / SST39VF3202

Not Recommended for New Designs

Product Identification

The Product Identification mode identifies the devices as the SST39VF1601, SST39VF1602, SST39VF3201, or SST39VF3202, and manufacturer as SST. This mode may be accessed software operations. Users may use the Software Product Identification operation to identify the part (i.e., using the device ID) when using multiple manufacturers in the same socket. For details, see Table 6 for software operation, Figure 12 for the Software ID Entry and Read timing diagram and Figure 22 for the Software ID Entry command sequence flowchart.

Table 4: Product Identification

	Address	Data
Manufacturer's ID	0000H	BFH
Device ID		
SST39VF1601	0001H	234BH
SST39VF1602	0001H	234AH
SST39VF3201	0001H	235BH
SST39VF3202	0001H	235AH

T4.2 25028

Product Identification Mode Exit/CFI Mode Exit

In order to return to the standard Read mode, the Software Product Identification mode must be exited. Exit is accomplished by issuing the Software ID Exit command sequence, which returns the device to the Read mode. This command may also be used to reset the device to the Read mode after any inadvertent transient condition that apparently causes the device to behave abnormally, e.g., not read correctly. Please note that the Software ID Exit/CFI Exit command is ignored during an internal Program or Erase operation. See Table 6 for software command codes, Figure 14 for timing waveform, and Figures 22 and 23 for flowcharts.

Security ID

The SST39VF160x/320x devices offer a 256-bit Security ID space. The Secure ID space is divided into two 128-bit segments - one factory programmed segment and one user programmed segment. The first segment is programmed and locked at SST with a random 128-bit number. The user segment is left un-programmed for the customer to program as desired.

To program the user segment of the Security ID, the user must use the Security ID Word-Program command. To detect end-of-write for the SEC ID, read the toggle bits. Do not use Data# Polling. Once this is complete, the Sec ID should be locked using the User Sec ID Program Lock-Out. This disables any future corruption of this space. Note that regardless of whether or not the Sec ID is locked, neither Sec ID segment can be erased.

The Secure ID space can be queried by executing a three-byte command sequence with Enter Sec ID command (88H) at address 5555H in the last byte sequence. To exit this mode, the Exit Sec ID command should be executed. Refer to Table 6 for more details.



Operations

Table 5: Operation Modes Selection

Mode	CE#	OE#	WE#	DQ	Address
Read	V _{IL}	V _{IL}	V _{IH}	D _{OUT}	A _{IN}
Program	V _{IL}	V _{IH}	V _{IL}	D _{IN}	A _{IN}
Erase	V _{IL}	V _{IH}	V _{IL}	X ¹	Sector or block address, XXH for Chip-Erase
Standby	V _{IH}	X	X	High Z	X
Write Inhibit	X	V _{IL}	X	High Z/ D _{OUT}	X
	X	X	V _{IH}	High Z/ D _{OUT}	X
Product Identification					
Software Mode	V _{IL}	V _{IL}	V _{IH}		See Table 6

T5.0 25028

1. X can be V_{IL} or V_{IH}, but no other value.

Table 6: Software Command Sequence

Command Sequence	1st Bus Write Cycle		2nd Bus Write Cycle		3rd Bus Write Cycle		4th Bus Write Cycle		5th Bus Write Cycle		6th Bus Write Cycle	
	Addr ¹	Data ²	Addr ¹	Data ²	Addr ¹	Data ²	Addr ¹	Data ²	Addr ¹	Data ²	Addr ¹	Data ²
Word-Program	5555H	AAH	2AAAH	55H	5555H	A0H	WA ³	Data				
Sector-Erase	5555H	AAH	2AAAH	55H	5555H	80H	5555H	AAH	2AAAH	55H	SA _X ⁴	30H
Block-Erase	5555H	AAH	2AAAH	55H	5555H	80H	5555H	AAH	2AAAH	55H	BA _X ⁴	50H
Chip-Erase	5555H	AAH	2AAAH	55H	5555H	80H	5555H	AAH	2AAAH	55H	5555H	10H
Erase-Suspend	XXXXH	B0H										
Erase-Resume	XXXXH	30H										
Query Sec ID ⁵	5555H	AAH	2AAAH	55H	5555H	88H						
User Security ID Word-Program	5555H	AAH	2AAAH	55H	5555H	A5H	WA ⁶	Data				
User Security ID Program Lock-Out	5555H	AAH	2AAAH	55H	5555H	85H	XXH ⁶	0000H				
Software ID Entry ^{7,8}	5555H	AAH	2AAAH	55H	5555H	90H						
CFI Query Entry	5555H	AAH	2AAAH	55H	5555H	98H						
Software ID Exit ^{9,10} /CFI Exit/Sec ID Exit	5555H	AAH	2AAAH	55H	5555H	F0H						
Software ID Exit ^{9,10} /CFI Exit/Sec ID Exit	XXH	F0H										

T6.6 25028

1. Address format A₁₄-A₀ (Hex).

Addresses A₁₅-A₁₉ can be V_{IL} or V_{IH}, but no other value, for Command sequence for SST39VF1601/1602,

Addresses A₁₅-A₂₀ can be V_{IL} or V_{IH}, but no other value, for Command sequence for SST39VF3201/3202,



16 Mbit / 32 Mbit Multi-Purpose Flash Plus

SST39VF1601 / SST39VF3201
SST39VF1602 / SST39VF3202

Not Recommended for New Designs

2. DQ₁₅-DQ₈ can be V_{IL} or V_{IH}, but no other value, for Command sequence
3. WA = Program Word address
4. SA_X for Sector-Erase; uses A_{MS}-A₁₁ address lines
BA_X, for Block-Erase; uses A_{MS}-A₁₅ address lines
A_{MS} = Most significant address
A_{MS} = A₁₉ for SST39VF1601/1602 and A₂₀ for SST39VF3201/3202
5. With A_{MS}-A₄ = 0; Sec ID is read with A₃-A₀,
SST ID is read with A₃ = 0 (Address range = 000000H to 000007H),
User ID is read with A₃ = 1 (Address range = 000010H to 000017H).
Lock Status is read with A₇-A₀ = 0000FFH. Unlocked: DQ₃ = 1 / Locked: DQ₃ = 0.
6. Valid Word-Addresses for Sec ID are from 000000H-000007H and 000010H-000017H.
7. The device does not remain in Software Product ID Mode if powered down.
8. With A_{MS}-A₁ = 0; SST Manufacturer ID = 00BFH, is read with A₀ = 0,
SST39VF1601 Device ID = 234BH, is read with A₀ = 1,
SST39VF1602 Device ID = 234AH, is read with A₀ = 1,
SST39VF3201 Device ID = 235BH, is read with A₀ = 1,
SST39VF3202 Device ID = 235AH, is read with A₀ = 1,
A_{MS} = Most significant address
A_{MS} = A₁₉ for SST39VF1601/1602 and A₂₀ for SST39VF3201/3202
9. Both Software ID Exit operations are equivalent
10. If users never lock after programming, Sec ID can be programmed over the previously unprogrammed bits (data=1) using the Sec ID mode again (the programmed "0" bits cannot be reversed to "1"). Valid Word-Addresses for Sec ID are from 000000H-000007H and 000010H-000017H.

Table 7: CFI Query Identification String¹ for SST39VF160x/320x

Address	Data	Data
10H	0051H	Query Unique ASCII string "QRY"
11H	0052H	
12H	0059H	
13H	0001H	Primary OEM command set
14H	0007H	
15H	0000H	Address for Primary Extended Table
16H	0000H	
17H	0000H	Alternate OEM command set (00H = none exists)
18H	0000H	
19H	0000H	Address for Alternate OEM extended Table (00H = none exists)
1AH	0000H	

T7.1 25028

1. Refer to CFI publication 100 for more details.



16 Mbit / 32 Mbit Multi-Purpose Flash Plus

SST39VF1601 / SST39VF3201
SST39VF1602 / SST39VF3202

Not Recommended for New Designs

Table 8: System Interface Information for SST39VF160x/320x

Address	Data	Data
1BH	0027H	V _{DD} Min (Program/Erase) DQ ₇ -DQ ₄ : Volts, DQ ₃ -DQ ₀ : 100 millivolts
1CH	0036H	V _{DD} Max (Program/Erase) DQ ₇ -DQ ₄ : Volts, DQ ₃ -DQ ₀ : 100 millivolts
1DH	0000H	V _{PP} min. (00H = no V _{PP} pin)
1EH	0000H	V _{PP} max. (00H = no V _{PP} pin)
1FH	0003H	Typical time out for Word-Program 2 ^N μs (2 ³ = 8 μs)
20H	0000H	Typical time out for min. size buffer program 2 ^N μs (00H = not supported)
21H	0004H	Typical time out for individual Sector/Block-Erase 2 ^N ms (2 ⁴ = 16 ms)
22H	0005H	Typical time out for Chip-Erase 2 ^N ms (2 ⁵ = 32 ms)
23H	0001H	Maximum time out for Word-Program 2 ^N times typical (2 ¹ x 2 ³ = 16 μs)
24H	0000H	Maximum time out for buffer program 2 ^N times typical
25H	0001H	Maximum time out for individual Sector/Block-Erase 2 ^N times typical (2 ¹ x 2 ⁴ = 32 ms)
26H	0001H	Maximum time out for Chip-Erase 2 ^N times typical (2 ¹ x 2 ⁵ = 64 ms)

T8.3 25028

Table 9: Device Geometry Information for SST39VF1601/1602

Address	Data	Data
27H	0015H	Device size = 2 ^N Bytes (15H = 21; 2 ²¹ = 2 MByte)
28H	0001H	Flash Device Interface description; 0001H = x16-only asynchronous interface
29H	0000H	
2AH	0000H	
2BH	0000H	Maximum number of byte in multi-byte write = 2 ^N (00H = not supported)
2CH	0002H	Number of Erase Sector/Block sizes supported by device
2DH	00FFH	Sector Information (y + 1 = Number of sectors; z x 256B = sector size)
2EH	0001H	y = 511 + 1 = 512 sectors (01FF = 511)
2FH	0010H	z = 16 x 256 Bytes = 4 KByte/sector (0010H = 16)
30H	0000H	
31H	001FH	Block Information (y + 1 = Number of blocks; z x 256B = block size)
32H	0000H	y = 31 + 1 = 32 blocks (001F = 31)
33H	0000H	z = 256 x 256 Bytes = 64 KByte/block (0100H = 256)
34H	0001H	

T9.0 25028



16 Mbit / 32 Mbit Multi-Purpose Flash Plus

SST39VF1601 / SST39VF3201

SST39VF1602 / SST39VF3202

Not Recommended for New Designs

Table 10: Device Geometry Information for SST39VF3201/3202

Address	Data	Data
27H	0016H	Device size = 2^N Bytes (16H = 22; 2^{22} = 4 MByte)
28H	0001H	Flash Device Interface description; 0001H = x16-only asynchronous interface
29H	0000H	
2AH	0000H	Maximum number of byte in multi-byte write = 2^N (00H = not supported)
2BH	0000H	
2CH	0002H	Number of Erase Sector/Block sizes supported by device
2DH	00FFH	Sector Information (y + 1 = Number of sectors; z x 256B = sector size)
2EH	0003H	y = 1023 + 1 = 1024 (03FFH = 1023)
2FH	0010H	
30H	0000H	z = 16 x 256 Bytes = 4 KBytes/sector (0010H = 16)
31H	003FH	Block Information (y + 1 = Number of blocks; z x 256B = block size)
32H	0000H	y = 63 + 1 = 64 blocks (003FH = 63)
33H	0000H	
34H	0001H	z = 256 x 256 Bytes = 64 KBytes/block (0100H = 256)

T10.2 25028



16 Mbit / 32 Mbit Multi-Purpose Flash Plus

SST39VF1601 / SST39VF3201
SST39VF1602 / SST39VF3202

Not Recommended for New Designs

Absolute Maximum Stress Ratings (Applied conditions greater than those listed under “Absolute Maximum Stress Ratings” may cause permanent damage to the device. This is a stress rating only and functional operation of the device at these conditions or conditions greater than those defined in the operational sections of this data sheet is not implied. Exposure to absolute maximum stress rating conditions may affect device reliability.)

Temperature Under Bias	-55°C to +125°C
Storage Temperature	-65°C to +150°C
D. C. Voltage on Any Pin to Ground Potential	-0.5V to V _{DD} +0.5V
Transient Voltage (<20 ns) on Any Pin to Ground Potential	-2.0V to V _{DD} +2.0V
Voltage on A ₉ Pin to Ground Potential	-0.5V to 13.2V
Package Power Dissipation Capability (T _A = 25°C)	1.0W
Surface Mount Solder Reflow Temperature ¹	260°C for 10 seconds
Output Short Circuit Current ²	50 mA

1. Excluding certain with-Pb 32-PLCC units, all packages are 260°C capable in both non-Pb and with-Pb solder versions. Certain with-Pb 32-PLCC package types are capable of 240°C for 10 seconds; please consult the factory for the latest information.
2. Outputs shorted for no more than one second. No more than one output shorted at a time.

Table 11: Operating Range

Range	Ambient Temp	V _{DD}
Commercial	0°C to +70°C	2.7-3.6V
Industrial	-40°C to +85°C	2.7-3.6V

T11.1 25028

Table 12: AC Conditions of Test¹

Input Rise/Fall Time	Output Load
5ns	C _L = 30 pF

T12.1 25028

1. See Figures 18 and 19



16 Mbit / 32 Mbit Multi-Purpose Flash Plus

SST39VF1601 / SST39VF3201
SST39VF1602 / SST39VF3202

Not Recommended for New Designs

Table 13: DC Operating Characteristics $V_{DD} = 2.7\text{-}3.6V^1$

Symbol	Parameter	Limits			Test Conditions
		Min	Max	Units	
I _{DD}	Power Supply Current				Address input= V_{ILT}/V_{IHT}^2 , at f=5 MHz, $V_{DD}=V_{DD} \text{ Max}$
	Read ³		18	mA	$CE\#=V_{IL}$, $OE\#=WE\#=V_{IH}$, all I/Os open
	Program and Erase		35	mA	$CE\#=WE\#=V_{IL}$, $OE\#=V_{IH}$
I _{SB}	Standby V_{DD} Current		20	μA	$CE\#=V_{IHC}$, $V_{DD}=V_{DD} \text{ Max}$
I _{ALP}	Auto Low Power		20	μA	$CE\#=V_{ILC}$, $V_{DD}=V_{DD} \text{ Max}$ All inputs= V_{SS} or V_{DD} , $WE\#=V_{IHC}$
I _{LI}	Input Leakage Current		1	μA	$V_{IN}=\text{GND to } V_{DD}$, $V_{DD}=V_{DD} \text{ Max}$
I _{LIW}	Input Leakage Current on WP# pin and RST#		10	μA	$WP\#=\text{GND to } V_{DD}$ or $RST\#=\text{GND to } V_{DD}$
I _{LO}	Output Leakage Current		10	μA	$V_{OUT}=\text{GND to } V_{DD}$, $V_{DD}=V_{DD} \text{ Max}$
V _{IL}	Input Low Voltage		0.8	V	$V_{DD}=V_{DD} \text{ Min}$
V _{ILC}	Input Low Voltage (CMOS)		0.3	V	$V_{DD}=V_{DD} \text{ Max}$
V _{IH}	Input High Voltage	$0.7V_{DD}$		V	$V_{DD}=V_{DD} \text{ Max}$
V _{IHC}	Input High Voltage (CMOS)	$V_{DD}-0.3$		V	$V_{DD}=V_{DD} \text{ Max}$
V _{OL}	Output Low Voltage		0.2	V	$I_{OL}=100 \mu A$, $V_{DD}=V_{DD} \text{ Min}$
V _{OH}	Output High Voltage	$V_{DD}-0.2$		V	$I_{OH}=-100 \mu A$, $V_{DD}=V_{DD} \text{ Min}$

T13.8 25028

1. Typical conditions for the Active Current shown on the front page of the data sheet are average values at 25°C (room temperature), and $V_{DD} = 3V$. Not 100% tested.
2. See Figure 18
3. The I_{DD} current listed is typically less than 2mA/MHz, with OE# at V_{IH} . Typical V_{DD} is 3V.

Table 14: Recommended System Power-up Timings

Symbol	Parameter	Minimum	Units
T _{PU-READ} ¹	Power-up to Read Operation	100	μs
T _{PU-WRITE} ¹	Power-up to Program/Erase Operation	100	μs

T14.0 25028

1. This parameter is measured only for initial qualification and after a design or process change that could affect this parameter.

Table 15: Capacitance ($T_A = 25^\circ C$, f=1 MHz, other pins open)

Parameter	Description	Test Condition	Maximum
C _{I/O} ¹	I/O Pin Capacitance	$V_{I/O} = 0V$	12 pF
C _{IN} ¹	Input Capacitance	$V_{IN} = 0V$	6 pF

T15.0 25028

1. This parameter is measured only for initial qualification and after a design or process change that could affect this parameter.

Table 16: Reliability Characteristics

Symbol	Parameter	Minimum Specification	Units	Test Method
N _{END} ^{1,2}	Endurance	10,000	Cycles	JEDEC Standard A117
T _{DR} ¹	Data Retention	100	Years	JEDEC Standard A103
I _{LTH} ¹	Latch Up	$100 + I_{DD}$	mA	JEDEC Standard 78

T16.2 25028

1. This parameter is measured only for initial qualification and after a design or process change that could affect this parameter.
2. N_{END} endurance rating is qualified as a 10,000 cycle minimum for the whole device. A sector- or block-level rating would result in a higher minimum specification.



AC Characteristics

Table 17: Read Cycle Timing Parameters $V_{DD} = 2.7-3.6V$

Symbol	Parameter	Min	Max	Units
T_{RC}	Read Cycle Time	70		ns
T_{CE}	Chip Enable Access Time		70	ns
T_{AA}	Address Access Time		70	ns
T_{OE}	Output Enable Access Time		35	ns
T_{CLZ}^1	CE# Low to Active Output	0		ns
T_{OLZ}^1	OE# Low to Active Output	0		ns
T_{CHZ}^1	CE# High to High-Z Output		20	ns
T_{OHZ}^1	OE# High to High-Z Output		20	ns
T_{OH}^1	Output Hold from Address Change	0		ns
T_{RP}^1	RST# Pulse Width	500		ns
T_{RHR}^1	RST# High before Read	50		ns
$T_{RY}^{1,2}$	RST# Pin Low to Read Mode		20	μs

T17.3 25028

1. This parameter is measured only for initial qualification and after a design or process change that could affect this parameter.
2. This parameter applies to Sector-Erase, Block-Erase and Program operations. This parameter does not apply to Chip-Erase operations.

Table 18: Program/Erase Cycle Timing Parameters

Symbol	Parameter	Min	Max	Units
T_{BP}	Word-Program Time		10	μs
T_{AS}	Address Setup Time	0		ns
T_{AH}	Address Hold Time	30		ns
T_{CS}	WE# and CE# Setup Time	0		ns
T_{CH}	WE# and CE# Hold Time	0		ns
T_{OES}	OE# High Setup Time	0		ns
T_{OEH}	OE# High Hold Time	10		ns
T_{CP}	CE# Pulse Width	40		ns
T_{WP}	WE# Pulse Width	40		ns
T_{WPH}^1	WE# Pulse Width High	30		ns
T_{CPH}^1	CE# Pulse Width High	30		ns
T_{DS}	Data Setup Time	30		ns
T_{DH}^1	Data Hold Time	0		ns
T_{IDA}^1	Software ID Access and Exit Time		150	ns
T_{SE}	Sector-Erase		25	ms
T_{BE}	Block-Erase		25	ms
T_{SCE}	Chip-Erase		50	ms

T18.1 25028

1. This parameter is measured only for initial qualification and after a design or process change that could affect this parameter.



16 Mbit / 32 Mbit Multi-Purpose Flash Plus

SST39VF1601 / SST39VF3201
SST39VF1602 / SST39VF3202

Not Recommended for New Designs



Figure 4: Read Cycle Timing Diagram



Figure 5: WE# Controlled Program Cycle Timing Diagram



16 Mbit / 32 Mbit Multi-Purpose Flash Plus

SST39VF1601 / SST39VF3201 SST39VF1602 / SST39VF3202

Not Recommended for New Designs



Figure 6: CE# Controlled Program Cycle Timing Diagram



Figure 7: Data# Polling Timing Diagram



16 Mbit / 32 Mbit Multi-Purpose Flash Plus

SST39VF1601 / SST39VF3201

SST39VF1602 / SST39VF3202

Not Recommended for New Designs

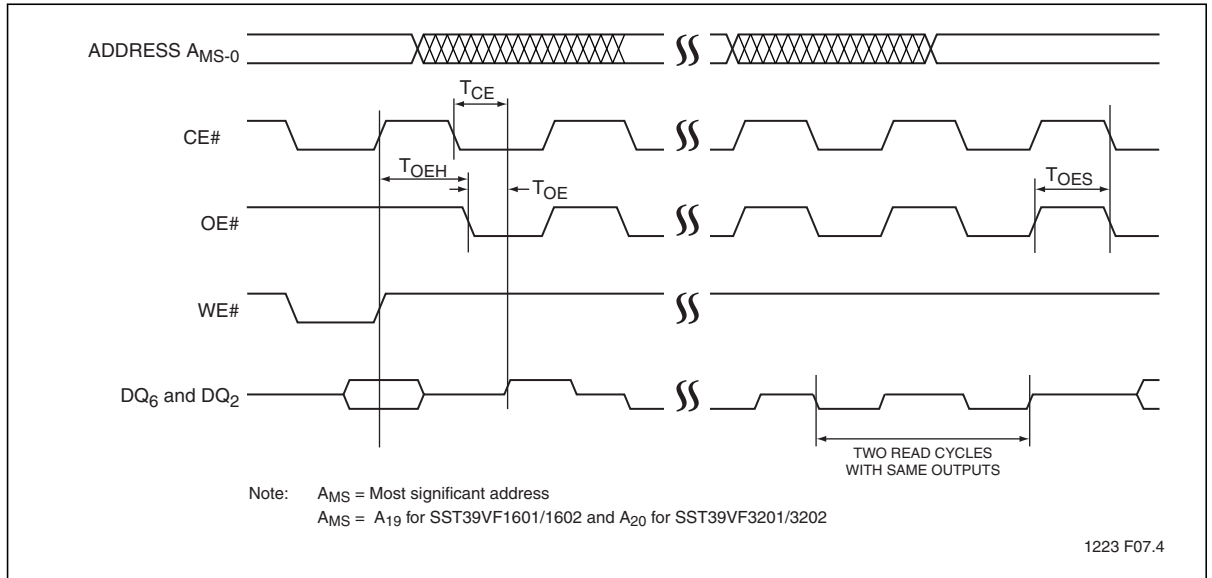

Figure 8: Toggle Bits Timing Diagram

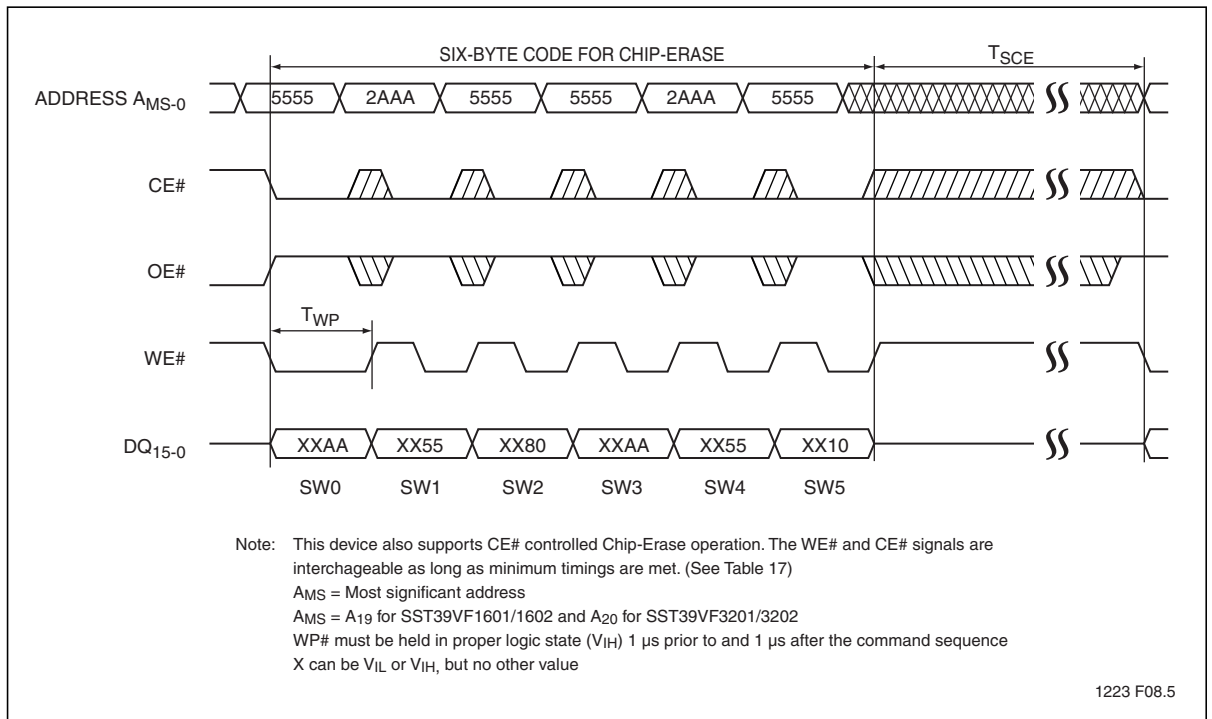

Figure 9: WE# Controlled Chip-Erase Timing Diagram



16 Mbit / 32 Mbit Multi-Purpose Flash Plus

SST39VF1601 / SST39VF3201
SST39VF1602 / SST39VF3202

Not Recommended for New Designs



Figure 10:WE# Controlled Block-Erase Timing Diagram



Figure 11:WE# Controlled Sector-Erase Timing Diagram



16 Mbit / 32 Mbit Multi-Purpose Flash Plus

SST39VF1601 / SST39VF3201
SST39VF1602 / SST39VF3202

Not Recommended for New Designs



Figure 12: Software ID Entry and Read



Figure 13: CFI Query Entry and Read

1223 F12.1



16 Mbit / 32 Mbit Multi-Purpose Flash Plus

SST39VF1601 / SST39VF3201
SST39VF1602 / SST39VF3202

Not Recommended for New Designs



Figure 14: Software ID Exit/CFI Exit



Figure 15: Sec ID Entry



16 Mbit / 32 Mbit Multi-Purpose Flash Plus

SST39VF1601 / SST39VF3201

SST39VF1602 / SST39VF3202

Not Recommended for New Designs



Figure 16:RST# Timing Diagram (When no internal operation is in progress)

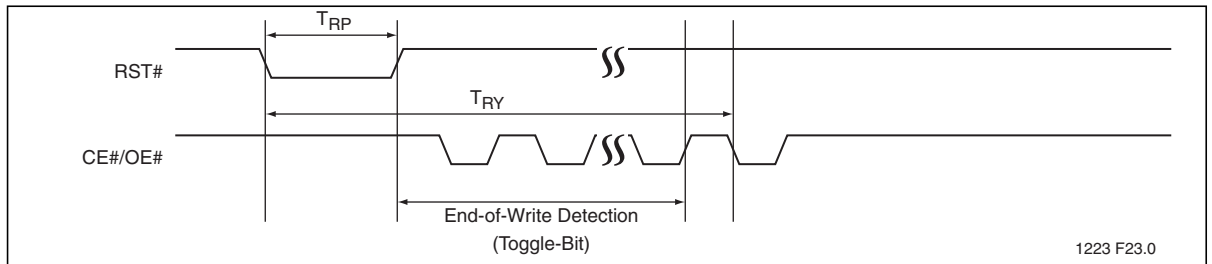

Figure 17:RST# Timing Diagram (During Program or Erase operation)

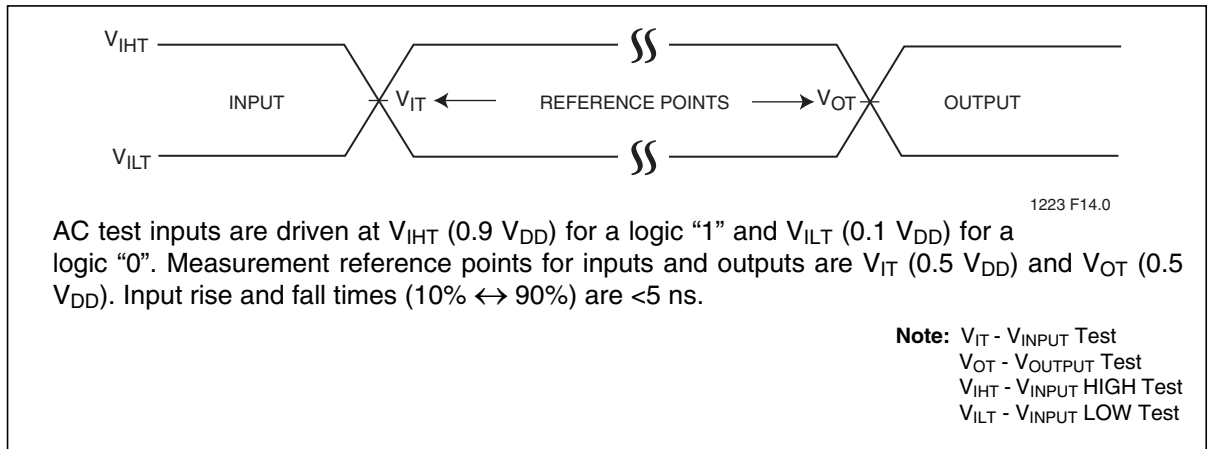

Figure 18:AC Input/Output Reference Waveforms

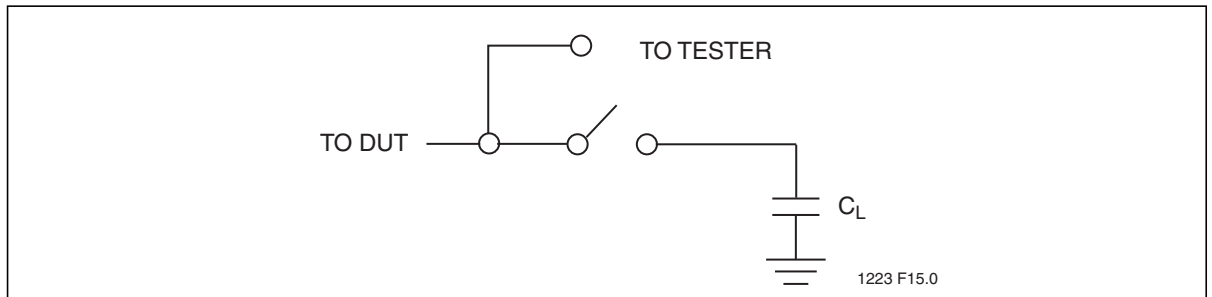

Figure 19:A Test Load Example



16 Mbit / 32 Mbit Multi-Purpose Flash Plus

SST39VF1601 / SST39VF3201

SST39VF1602 / SST39VF3202

Not Recommended for New Designs

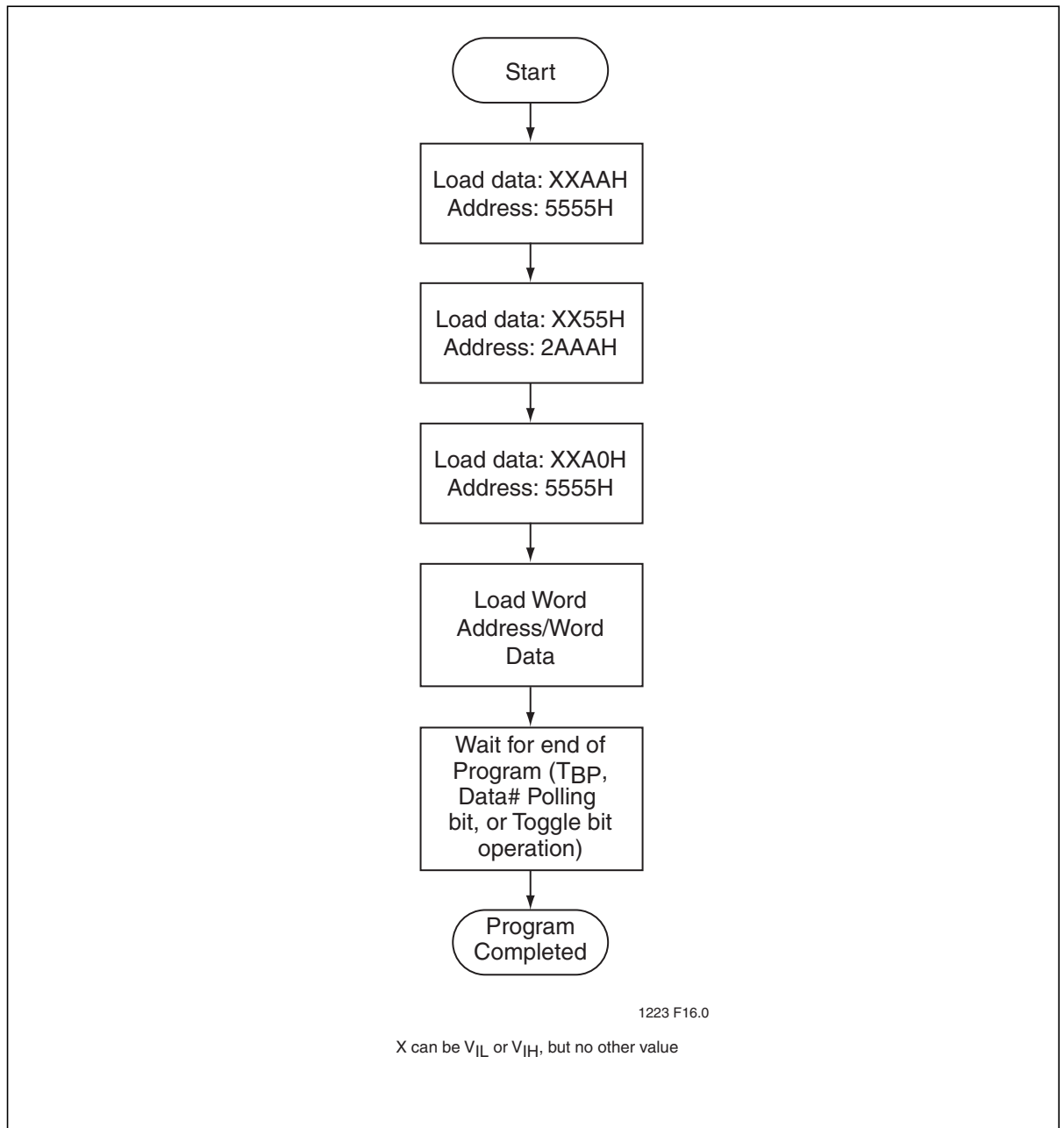

Figure 20: Word-Program Algorithm



16 Mbit / 32 Mbit Multi-Purpose Flash Plus

SST39VF1601 / SST39VF3201

SST39VF1602 / SST39VF3202

Not Recommended for New Designs

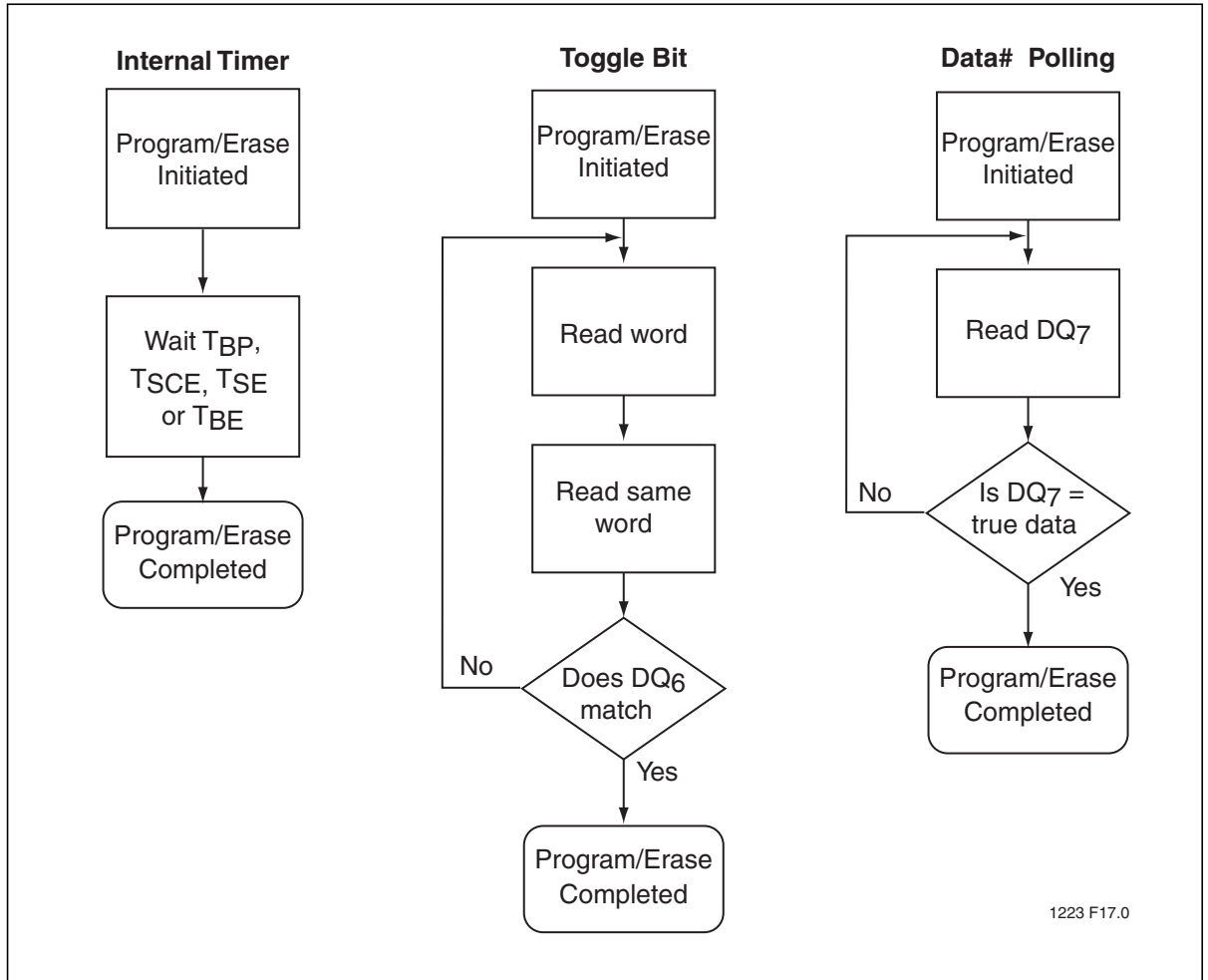

Figure 21: Wait Options



16 Mbit / 32 Mbit Multi-Purpose Flash Plus

SST39VF1601 / SST39VF3201

SST39VF1602 / SST39VF3202

Not Recommended for New Designs

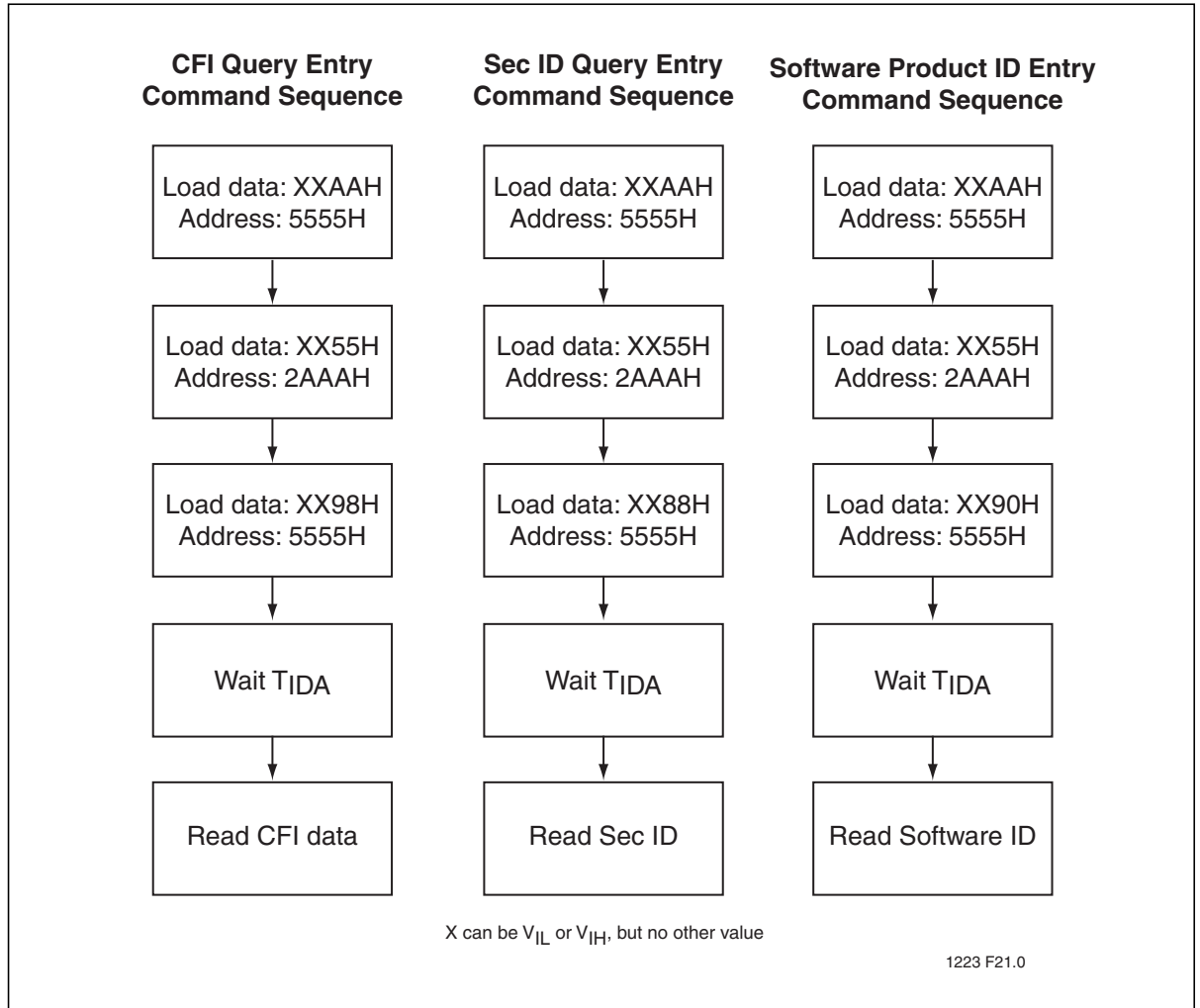

Figure 22: Software ID/CFI Entry Command Flowcharts



16 Mbit / 32 Mbit Multi-Purpose Flash Plus

SST39VF1601 / SST39VF3201

SST39VF1602 / SST39VF3202

Not Recommended for New Designs



Figure 23: Software ID/CFI Exit Command Flowcharts



16 Mbit / 32 Mbit Multi-Purpose Flash Plus

SST39VF1601 / SST39VF3201

SST39VF1602 / SST39VF3202

Not Recommended for New Designs



Figure 24:Erase Command Sequence



16 Mbit / 32 Mbit Multi-Purpose Flash Plus

SST39VF1601 / SST39VF3201

SST39VF1602 / SST39VF3202

Not Recommended for New Designs

Product Ordering Information



1. Environmental suffix "E" denotes non-Pb solder.
SST non-Pb solder devices are "RoHS Compliant".



16 Mbit / 32 Mbit Multi-Purpose Flash Plus

SST39VF1601 / SST39VF3201
SST39VF1602 / SST39VF3202

Not Recommended for New Designs

Valid Combinations for SST39VF1601

SST39VF1601-70-4C-EKE	SST39VF1601-70-4C-B3KE
SST39VF1601-90-4C-EKE	SST39VF1601-90-4C-B3KE
SST39VF1601-70-4I-EKE	SST39VF1601-70-4I-B3KE
SST39VF1601-90-4I-EKE	SST39VF1601-90-4I-B3KE

Valid Combinations for SST39VF1602

SST39VF1602-70-4C-EKE	SST39VF1602-70-4C-B3KE
SST39VF1602-90-4C-EKE	SST39VF1602-90-4C-B3KE
SST39VF1602-70-4I-EKE	SST39VF1602-70-4I-B3KE
SST39VF1602-90-4I-EKE	SST39VF1602-90-4I-B3KE

Valid Combinations for SST39VF3201

SST39VF3201-70-4C-EKE	SST39VF3201-70-4C-B3KE
SST39VF3201-90-4C-EKE	SST39VF3201-90-4C-B3KE
SST39VF3201-70-4I-EKE	SST39VF3201-70-4I-B3KE
SST39VF3201-90-4I-EKE	SST39VF3201-90-4I-B3KE

Valid Combinations for SST39VF3202

SST39VF3202-70-4C-EKE	SST39VF3202-70-4C-B3KE
SST39VF3202-90-4C-EKE	SST39VF3202-90-4C-B3KE
SST39VF3202-70-4I-EKE	SST39VF3202-70-4I-B3KE
SST39VF3202-90-4I-EKE	SST39VF3202-90-4I-B3KE

Note: Valid combinations are those products in mass production or will be in mass production. Consult your SST sales representative to confirm availability of valid combinations and to determine availability of new combinations.



A Microchip Technology Company

16 Mbit / 32 Mbit Multi-Purpose Flash Plus

SST39VF1601 / SST39VF3201

SST39VF1602 / SST39VF3202

Not Recommended for New Designs

Packaging Diagrams



Figure 25:48-lead Thin Small Outline Package (TSOP) 12mm x 20mm
SST Package Code: EK



16 Mbit / 32 Mbit Multi-Purpose Flash Plus

SST39VF1601 / SST39VF3201 SST39VF1602 / SST39VF3202

Not Recommended for New Designs



Figure 26:48-ball Thin-profile, Fine-pitch Ball Grid Array (TFBGA) 6mm x 8mm
SST Package Code: B3K



16 Mbit / 32 Mbit Multi-Purpose Flash Plus

SST39VF1601 / SST39VF3201 SST39VF1602 / SST39VF3202

Not Recommended for New Designs

Table 19: Revision History

Number	Description	Date
00	<ul style="list-style-type: none"> Initial release 	Mar 2003
01	<ul style="list-style-type: none"> Corrected Pin 15 from A20 to NC for SST39VF160x in Figure 2 on page 4 	Apr 2003
02	<ul style="list-style-type: none"> Changed data sheet title 	Jun 2003
03	<ul style="list-style-type: none"> 2004 Data Book Updated the B3K and B1K package diagrams Added non-Pb MPNs and removed footnote. (See page 31) 	Nov 2003
04	<ul style="list-style-type: none"> Added RoHS compliance information on page 1 and in the "Product Ordering Information" on page 30 Corrected the solder temperature profile in "Absolute Maximum Stress Ratings" on page 15 Changed product status from "Preliminary Specifications" to "Data Sheet" 	Nov 2005
05	<ul style="list-style-type: none"> Removed 90 ns Read Access Time globally EOLed all lead (Pb) valid combinations. See S71223(02) EOLed SST39VF6401 and SST39VF6402. See S71223(03) 	June 2008
A	<ul style="list-style-type: none"> Changed document status to "Not Recommended for New Designs" Applied new document format Released document under letter revision system Updated Spec number from S71223 to DS25028 	Aug 2011

ISBN:978-1-61341-355-5

© 2011 Silicon Storage Technology, Inc—a Microchip Technology Company. All rights reserved.

SST, Silicon Storage Technology, the SST logo, SuperFlash, MTP, and FlashFlex are registered trademarks of Silicon Storage Technology, Inc. MPF, SQI, Serial Quad I/O, and Z-Scale are trademarks of Silicon Storage Technology, Inc. All other trademarks and registered trademarks mentioned herein are the property of their respective owners.

Specifications are subject to change without notice. Refer to www.microchip.com for the most recent documentation. For the most current package drawings, please see the Packaging Specification located at <http://www.microchip.com/packaging>.

Memory sizes denote raw storage capacity; actual usable capacity may be less.

SST makes no warranty for the use of its products other than those expressly contained in the Standard Terms and Conditions of Sale.

For sales office locations and information, please see www.microchip.com.

Silicon Storage Technology, Inc.
A Microchip Technology Company
www.microchip.com

Компания «Океан Электроники» предлагает заключение долгосрочных отношений при поставках импортных электронных компонентов на взаимовыгодных условиях!

Наши преимущества:

- Поставка оригинальных импортных электронных компонентов напрямую с производств Америки, Европы и Азии, а так же с крупнейших складов мира;
- Широкая линейка поставок активных и пассивных импортных электронных компонентов (более 30 млн. наименований);
- Поставка сложных, дефицитных, либо снятых с производства позиций;
- Оперативные сроки поставки под заказ (от 5 рабочих дней);
- Экспресс доставка в любую точку России;
- Помощь Конструкторского Отдела и консультации квалифицированных инженеров;
- Техническая поддержка проекта, помощь в подборе аналогов, поставка прототипов;
- Поставка электронных компонентов под контролем ВП;
- Система менеджмента качества сертифицирована по Международному стандарту ISO 9001;
- При необходимости вся продукция военного и аэрокосмического назначения проходит испытания и сертификацию в лаборатории (по согласованию с заказчиком);
- Поставка специализированных компонентов военного и аэрокосмического уровня качества (Xilinx, Altera, Analog Devices, Intersil, Interpoint, Microsemi, Actel, Aeroflex, Peregrine, VPT, Syfer, Eurofarad, Texas Instruments, MS Kennedy, Miteq, Cobham, E2V, MA-COM, Hittite, Mini-Circuits, General Dynamics и др.);

Компания «Океан Электроники» является официальным дистрибьютором и эксклюзивным представителем в России одного из крупнейших производителей разъемов военного и аэрокосмического назначения «JONHON», а так же официальным дистрибьютором и эксклюзивным представителем в России производителя высокотехнологичных и надежных решений для передачи СВЧ сигналов «FORSTAR».



JONHON

«JONHON» (основан в 1970 г.)

Разъемы специального, военного и аэрокосмического назначения:

(Применяются в военной, авиационной, аэрокосмической, морской, железнодорожной, горно- и нефтедобывающей отраслях промышленности)

«FORSTAR» (основан в 1998 г.)

ВЧ соединители, коаксиальные кабели, кабельные сборки и микроволновые компоненты:

(Применяются в телекоммуникациях гражданского и специального назначения, в средствах связи, РЛС, а так же военной, авиационной и аэрокосмической отраслях промышленности).



Телефон: 8 (812) 309-75-97 (многоканальный)

Факс: 8 (812) 320-03-32

Электронная почта: ocean@oceanchips.ru

Web: <http://oceanchips.ru/>

Адрес: 198099, г. Санкт-Петербург, ул. Калинина, д. 2, корп. 4, лит. А