

## RL78/L13

R01DS0168EJ0210

## RENESAS MCU

Rev.2.10

Aug 12, 2016

Integrated LCD controller/driver, True Low Power Platform (as low as 112.5  $\mu$ A/MHz, and 0.61  $\mu$ A for RTC + LVD), 1.6 V to 5.5 V operation, 16 to 128 Kbyte Flash, 31 DMIPS at 24 MHz, for All LCD Based Applications

## 1. OUTLINE

### <R> 1.1 Features

#### Ultra-low power consumption technology

- $V_{DD}$  = single power supply voltage of 1.6 to 5.5 V which can operate a 1.8 V device at a low voltage
- HALT mode
- STOP mode
- SNOOZE mode

#### RL78 CPU core

- CISC architecture with 3-stage pipeline
- Minimum instruction execution time: Can be changed from high speed (0.04167  $\mu$ s: @ 24 MHz operation with high-speed on-chip oscillator) to ultra-low speed (30.5  $\mu$ s: @ 32.768 kHz operation with subsystem clock)
- Address space: 1 MB
- General-purpose registers: (8-bit register  $\times$  8)  $\times$  4 banks
- On-chip RAM: 1 to 8 KB

#### Code flash memory

- Code flash memory: 16 to 128 KB
- Block size: 1 KB
- Prohibition of block erase and rewriting (security function)
- On-chip debug function
- Self-programming (with boot swap function/flash shield window function)

#### Data flash memory

- Data flash memory: 4 KB
- Back ground operation (BGO): Instructions can be executed from the program memory while rewriting the data flash memory.
- Number of rewrites: 1,000,000 times (TYP.)
- Voltage of rewrites:  $V_{DD}$  = 1.8 to 5.5 V

#### High-speed on-chip oscillator

- Select from 48 MHz, 24 MHz, 16 MHz, 12 MHz, 8 MHz, 6 MHz, 4 MHz, 3 MHz, 2 MHz, and 1 MHz
- High accuracy:  $\pm 1.0\%$  ( $V_{DD}$  = 1.8 to 5.5 V,  $T_A$  = -20 to +85°C)

#### Operating ambient temperature

- $T_A$  = -40 to +85°C (A: Consumer applications)
- $T_A$  = -40 to +105°C (G: Industrial applications)

#### Power management and reset function

- On-chip power-on-reset (POR) circuit
- On-chip voltage detector (LVD) (Select interrupt and reset from 14 levels)

#### DMA (Direct Memory Access) controller

- 4 channels
- Number of clocks during transfer between 8/16-bit SFR and internal RAM: 2 clocks

#### Multiplier and divider/multiplier-accumulator

- 16 bits  $\times$  16 bits = 32 bits (Unsigned or signed)
- 32 bits  $\div$  32 bits = 32 bits (Unsigned)
- 16 bits  $\times$  16 bits + 32 bits = 32 bits (Unsigned or signed)

#### Serial interface

- CSI: 2 channels
- UART/UART (LIN-bus supported): 3, 4 channels/1 channel
- I<sup>2</sup>C/Simplified I<sup>2</sup>C communication: 1 channel/2 channels

#### Timer

- 16-bit timer: 8 channels (with remote control output function)
- 16-bit timer KB20 (IH): 1 channel (IH-only PWM output function)
- 12-bit interval timer: 1 channel
- Real-time clock 2: 1 channel (calendar for 99 years, alarm function, and clock correction function)
- Watchdog timer: 1 channel (operable with the dedicated low-speed on-chip oscillator)

#### A/D converter

- 8/10-bit resolution A/D converter ( $V_{DD}$  = 1.6 to 5.5 V)
- Analog input: 9 to 12 channels
- Internal reference voltage (1.45 V) and temperature sensor<sup>Note 1</sup>

#### Comparator

- 2 channels
- Operation mode: Comparator high-speed mode, comparator low-speed mode, or window mode
- External reference voltage and internal reference voltage are selectable

#### LCD controller/driver

- Segment signal output: 36 (32)<sup>Note 2</sup> to 51 (47)<sup>Note 2</sup>
- Common signal output: 4 (8)<sup>Note 2</sup>
- Internal voltage boosting method, capacitor split method, and external resistance division method are switchable

#### I/O port

- I/O port: 49 to 65 (N-ch open drain I/O [withstand voltage of 6 V]: 2, N-ch open drain I/O [V<sub>DD</sub> withstand voltage]: 12 to 18)
- Can be set to N-ch open drain, TTL input buffer, and on-chip pull-up resistor
- Different potential interface: Can connect to a 1.8/2.5/3 V device
- On-chip key interrupt function
- On-chip clock output/buzzer output controller

#### Others

- On-chip BCD (binary-coded decimal) correction circuit

Notes 1. Can be selected only in HS (high-speed main) mode  
2. The values in parentheses are the number of signal outputs when 8 com is used.

Remark The functions mounted depend on the product. See 1.6 Outline of Functions.

\* There are differences in specifications between every product.  
Please refer to specification for details.

## ○ ROM, RAM capacities

Flash ROM	Data Flash	RAM	RL78/L13	
			64 pins	80 pins
128 KB	4 KB	8 KB <sup>Note</sup>	R5F10WLG	R5F10WVG
96 KB	4 KB	6 KB	R5F10WLF	R5F10WVF
64 KB	4 KB	4 KB	R5F10WLE	R5F10WVE
48 KB	4 KB	2 KB	R5F10WLD	R5F10WVD
32 KB	4 KB	1.5 KB	R5F10WLC	R5F10WVC
16 KB	4 KB	1 KB	R5F10WLA	R5F10VVA

**Note** This is about 7 KB when the self-programming function and data flash function are used. (For details, see **CHAPTER 3** in the RL78/L13 User's Manual.)

1.2 List of Part Numbers

Figure 1-1. Part Number, Memory Size, and Package of RL78/L13

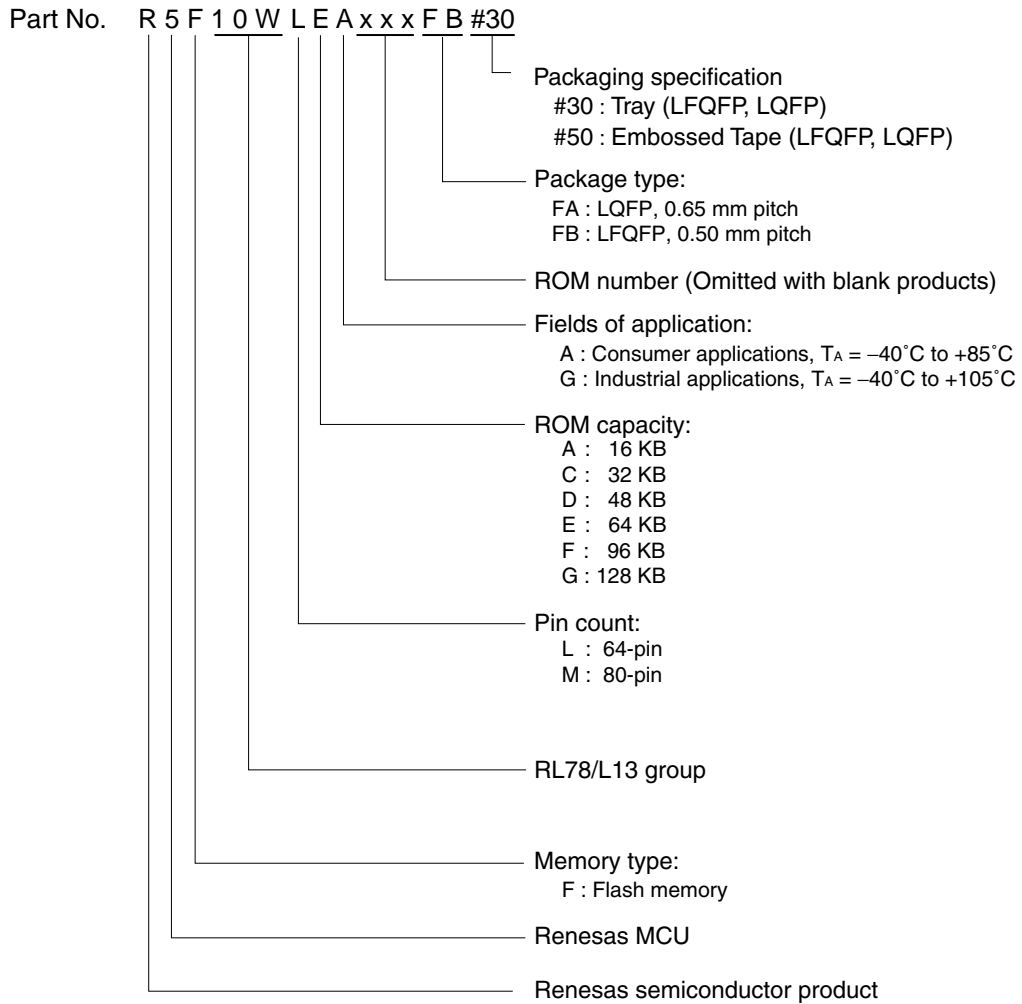

Pin Count	Package	Data Flash	Fields of Application <sup>Note</sup>	Ordering Part Number
64 pins	64-pin plastic LQFP (12 × 12 mm, 0.65 mm pitch)	Mounted	A	R5F10WLAFA#30, R5F10WLAFA#50, R5F10WLCAFA#30, R5F10WLCAFA#50, R5F10WLDAFA#30, R5F10WLDAFA#50, R5F10WLEAFA#30, R5F10WLEAFA#50, R5F10WLFafa#30, R5F10WLFafa#50, R5F10WLGafa#30, R5F10WLGafa#50
	64-pin plastic LFQFP (10 × 10 mm, 0.5 mm pitch)	Mounted	A  G	R5F10WLAafb#30, R5F10WLAafb#50, R5F10WLCAfb#30, R5F10WLCAfb#50, R5F10WLDAfb#30, R5F10WLDAfb#50, R5F10WLEafb#30, R5F10WLEafb#50, R5F10WLFafb#30, R5F10WLFafb#50, R5F10WLGafb#30, R5F10WLGafb#50, R5F10WLAGfb#30, R5F10WLAGfb#50, R5F10WLCGfb#30, R5F10WLCGfb#50, R5F10WLDGfb#30, R5F10WLDGfb#50, R5F10WLEGfb#30, R5F10WLEGfb#50, R5F10WLFgfb#30, R5F10WLFgfb#50, R5F10WLGgfb#30, R5F10WLGgfb#50
80 pins	80-pin plastic LQFP (14 × 14 mm, 0.65 mm pitch)	Mounted	A	R5F10WMAAFA#30, R5F10WMAAFA#50, R5F10WMCAFA#30, R5F10WMCAFA#50, R5F10WMDAFA#30, R5F10WMDAFA#50, R5F10WMEAFA#30, R5F10WMEAFA#50, R5F10WMFAFA#30, R5F10WMFAFA#50, R5F10WMGAFA#30, R5F10WMGAFA#50
	80-pin plastic LFQFP (12 × 12 mm, 0.5 mm pitch)	Mounted	A  G	R5F10WMAafb#30, R5F10WMAafb#50, R5F10WMCafb#30, R5F10WMCafb#50, R5F10WMDafb#30, R5F10WMDafb#50, R5F10WMEafb#30, R5F10WMEafb#50, R5F10WMfab#30, R5F10WMfab#50, R5F10WMGafb#30, R5F10WMGafb#50, R5F10WMAGfb#30, R5F10WMAGfb#50, R5F10WMCgfb#30, R5F10WMCgfb#50, R5F10WMDgfb#30, R5F10WMDgfb#50, R5F10WMEgfb#30, R5F10WMEgfb#50, R5F10WMfgfb#30, R5F10WMfgfb#50, R5F10WMGgfb#30, R5F10WMGgfb#50

**Note** For the fields of application, see **Figure 1-1 Part Number, Memory Size, and Package of RL78/L13**.

**Caution** The ordering part numbers represent the numbers at the time of publication. For the latest ordering part numbers, refer to the target product page of the Renesas Electronics website.

### 1.3 Pin Configuration (Top View)

#### <R> 1.3.1 64-pin products

- 64-pin plastic LQFP (12 × 12 mm, 0.65 mm pitch)
- 64-pin plastic LFQFP (10 × 10 mm, 0.5 mm pitch)

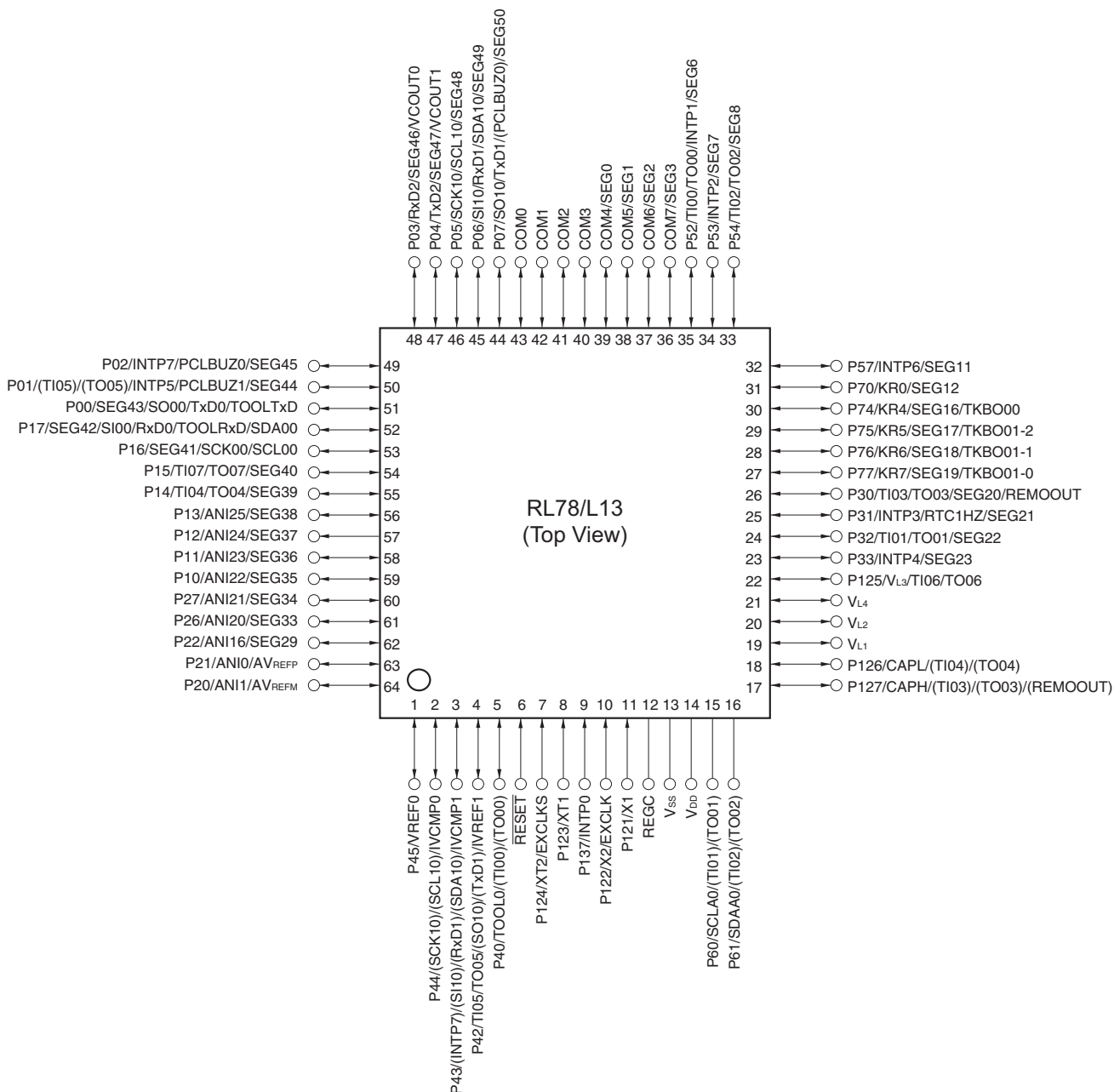

**Caution** Connect the REGC pin to V<sub>SS</sub> via a capacitor (0.47 to 1 μF).

**Remarks 1.** For pin identification, see 1.4 Pin Identification.

**2.** Functions in parentheses in the above figure can be assigned via settings in the peripheral I/O redirection register (PIOR). See **Figure 4-8 Format of Peripheral I/O Redirection Register (PIOR)** in the RL78/L13 User's Manual.

<R> 1.3.2 80-pin products

- 80-pin plastic LQFP (14 × 14 mm, 0.65 mm pitch)
- 80-pin plastic LFQFP (12 × 12 mm, 0.5 mm pitch)

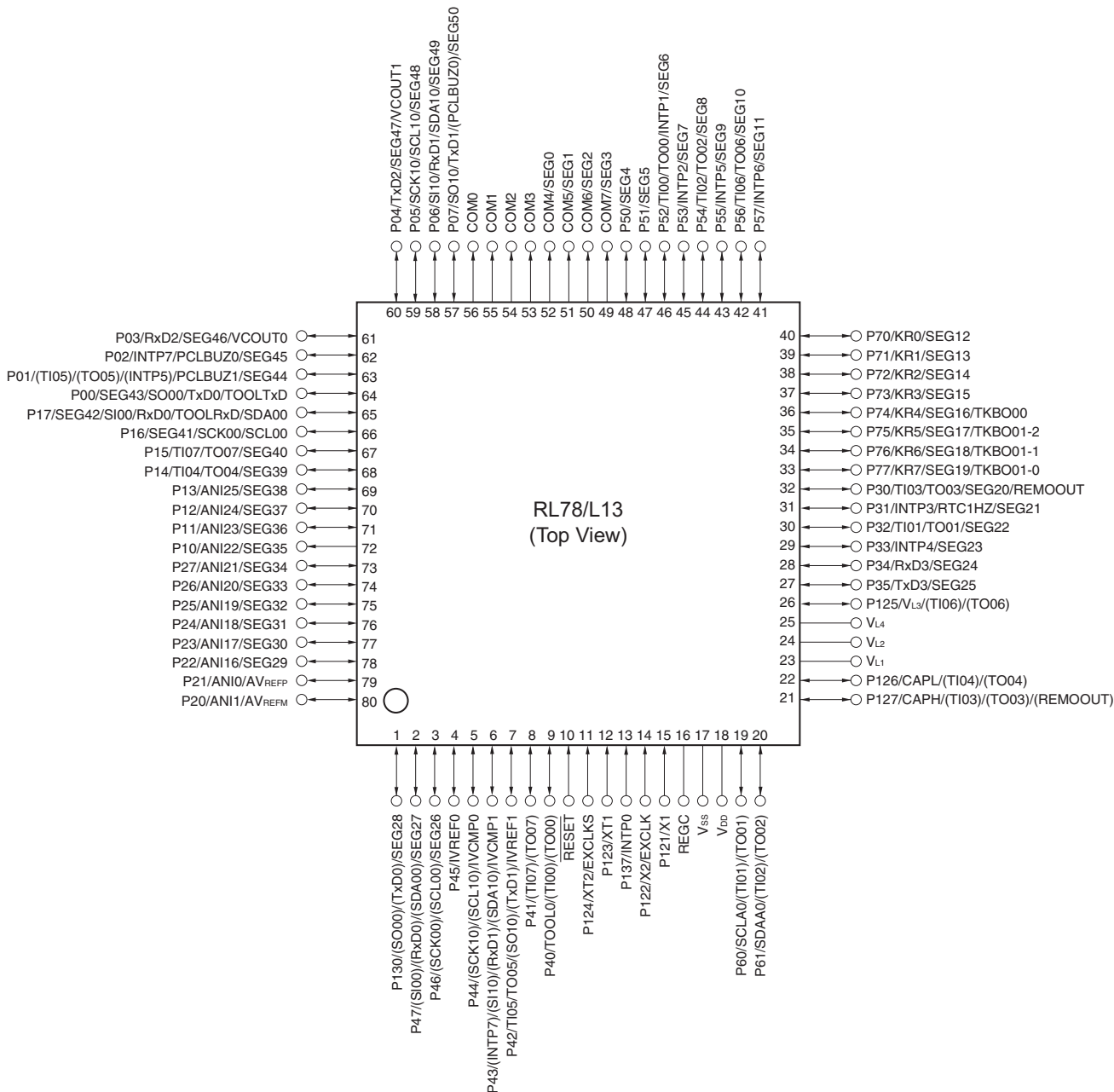

**Caution** Connect the REGC pin to V<sub>SS</sub> via a capacitor (0.47 to 1 μF).

- Remarks**
1. For pin identification, see 1.4 Pin Identification.
  2. Functions in parentheses in the above figure can be assigned via settings in the peripheral I/O redirection register (PIOR). See Figure 4-8 Format of Peripheral I/O Redirection Register (PIOR) in the RL78/L13 User's Manual.

## 1.4 Pin Identification

ANI0, ANI1, ANI16 to ANI25:	Analog Input	PCLBUZ0, PCLBUZ1:	Programmable Clock Output/ Buzzer Output
AVREFM:	Analog Reference Voltage Minus	REGC:	Regulator Capacitance
AVREFP:	Analog Reference Voltage Plus	REMOOUT:	Remote control Output
CAPH, CAPL:	Capacitor for LCD	$\overline{\text{RESET}}$ :	Reset
COM0 to COM7:	LCD Common Output	RTC1HZ:	Real-time Clock 2 Correction Clock (1 Hz) Output
EXCLK:	External Clock Input (Main System Clock)	RxD0 to RxD3:	Receive Data
EXCLKS:	External Clock Input (Subsystem Clock)	SCK00, SCK10, SCLA0:	Serial Clock Input/Output
INTP0 to INTP7:	External Interrupt Input	SCL00, SCL10:	Serial Clock Output
IVCMP0, IVCMP1:	Comparator Input	SDAA0, SDA00, SDA10:	Serial Data Input/Output
IVREF0, IVREF1:	Comparator Reference Input	SEG0 to SEG50:	LCD Segment Output
KR0 to KR7:	Key Return	SI00, SI10:	Serial Data Input
P00 to P07:	Port 0	SO00, SO10:	Serial Data Output
P10 to P17:	Port 1	TI00 to TI07:	Timer Input
P20 to P27:	Port 2	TO00 to TO07, TKBO00, TKBO01-0, TKBO01-1, TKBO01-2:	Timer Output
P30 to P35:	Port 3	TOOL0:	Data Input/Output for Tool
P40 to P47:	Port 4	TOOLRxD, TOOLTxD:	Data Input/Output for External Device
P50 to P57:	Port 5	TxD0 to TxD3:	Transmit Data
P60, P61:	Port 6	VCOUT0, VCOUT1:	Comparator Output
P70 to P77:	Port 7	V <sub>DD</sub> :	Power Supply
P121 to P127:	Port 12	V <sub>L1</sub> to V <sub>L4</sub> :	LCD Power Supply
P130, P137:	Port 13	V <sub>SS</sub> :	Ground
		X1, X2:	Crystal Oscillator (Main System Clock)
		XT1, XT2:	Crystal Oscillator (Subsystem Clock)

1.5 Block Diagram

1.5.1 64-pin products

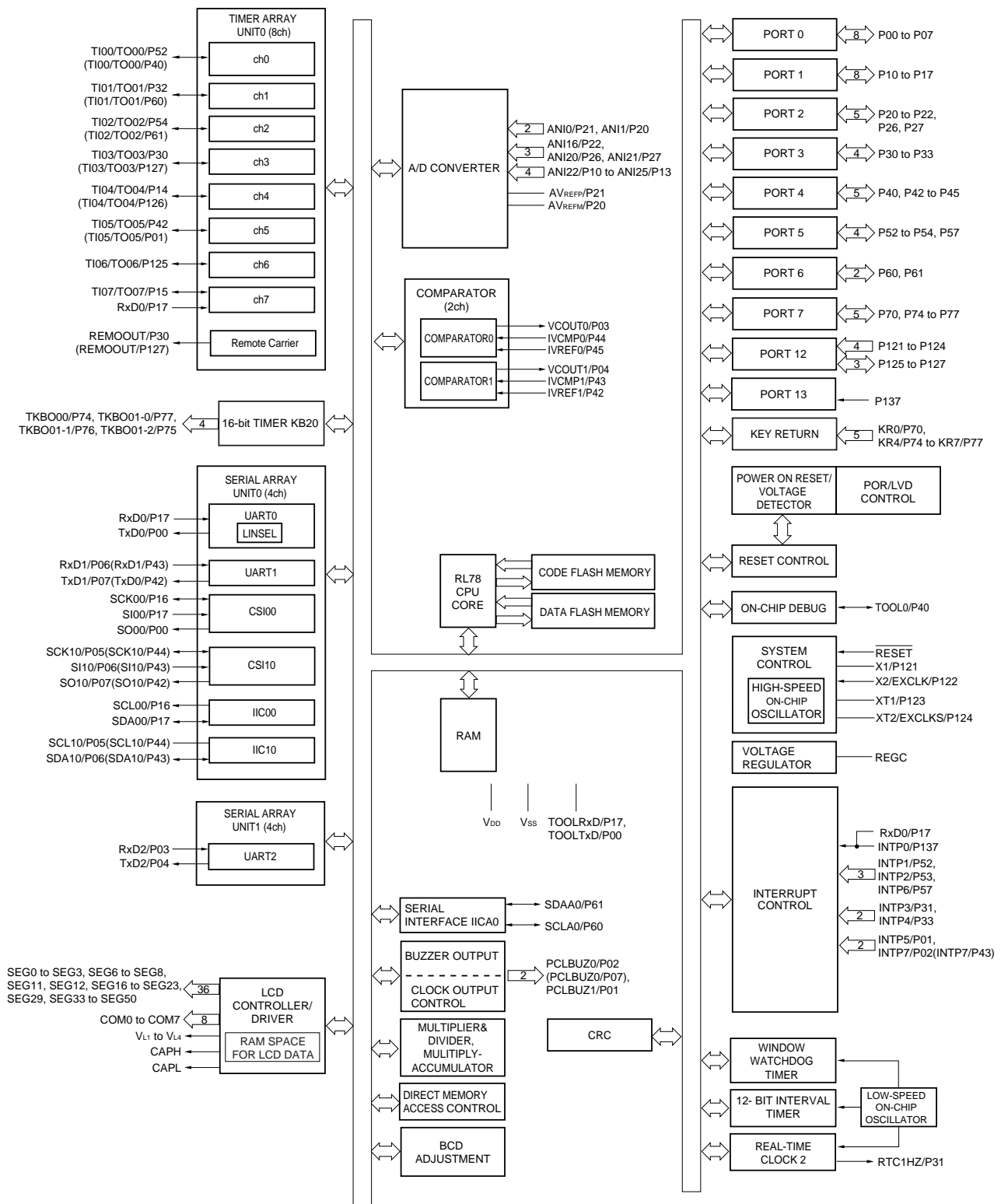

**Remark** Functions in parentheses in the above figure can be assigned via settings in the peripheral I/O redirection register (PIOR). See **Figure 4-8 Format of Peripheral I/O Redirection Register (PIOR)** in the RL78/L13 User's Manual.



1.5.2 80-pin products

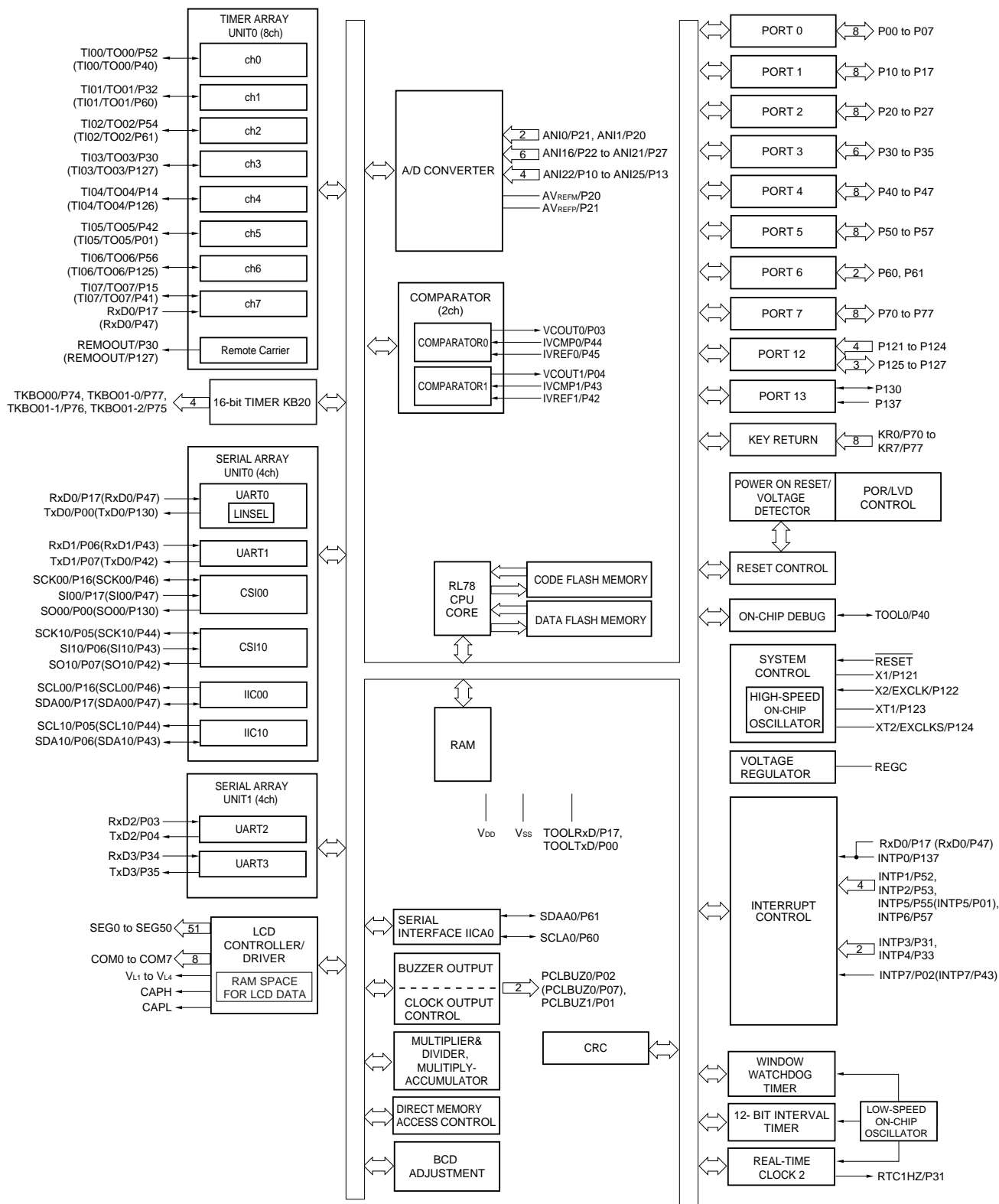

**Remark** Functions in parentheses in the above figure can be assigned via settings in the peripheral I/O redirection register (PIOR). See **Figure 4-8 Format of Peripheral I/O Redirection Register (PIOR)** in the RL78/L13 User's Manual.

## 1.6 Outline of Functions

(1/2)

Item		64-pin	80-pin
		R5F10WLx (x = A, C-G)	R5F10WMx (x = A, C-G)
Code flash memory (KB)		16 to 128	16 to 128
Data flash memory (KB)		4	4
RAM (KB)		1 to 8 <sup>Note 1</sup>	1 to 8 <sup>Note 1</sup>
Address space		1 MB	
<R>	Main system clock	X1 (crystal/ceramic) oscillation, external main system clock input (EXCLK) HS (High-speed main) mode: 1 to 20 MHz ( $V_{DD} = 2.7$ to 5.5 V), HS (High-speed main) mode: 1 to 16 MHz ( $V_{DD} = 2.4$ to 5.5 V), LS (Low-speed main) mode: 1 to 8 MHz ( $V_{DD} = 1.8$ to 5.5 V), LV (Low-voltage main) mode: 1 to 4 MHz ( $V_{DD} = 1.6$ to 5.5 V)	
	High-speed on-chip oscillator	HS (High-speed main) mode: 1 to 24 MHz ( $V_{DD} = 2.7$ to 5.5 V), HS (High-speed main) mode: 1 to 16 MHz ( $V_{DD} = 2.4$ to 5.5 V), LS (Low-speed main) mode: 1 to 8 MHz ( $V_{DD} = 1.8$ to 5.5 V), LV (Low-voltage main) mode: 1 to 4 MHz ( $V_{DD} = 1.6$ to 5.5 V)	
Clock for 16-bit timer KB20		48 MHz (TYP.): $V_{DD} = 2.7$ to 5.5 V	
Subsystem clock		XT1 (crystal) oscillation, external subsystem clock input (EXCLKS) 32.768 kHz (TYP.): $V_{DD} = 1.6$ to 5.5 V	
Low-speed on-chip oscillator		15 kHz (TYP.)	
General-purpose register		(8-bit register $\times$ 8) $\times$ 4 banks	
Minimum instruction execution time		0.04167 $\mu$ s (High-speed on-chip oscillator: $f_H = 24$ MHz operation)	
		0.05 $\mu$ s (High-speed system clock: $f_{MX} = 20$ MHz operation)	
		30.5 $\mu$ s (Subsystem clock: $f_{SUB} = 32.768$ kHz operation)	
Instruction set		<ul style="list-style-type: none"> <li>• Data transfer (8/16 bits)</li> <li>• Adder and subtractor/logical operation (8/16 bits)</li> <li>• Multiplication (8 bits <math>\times</math> 8 bits)</li> <li>• Rotate, barrel shift, and bit manipulation (Set, reset, test, and Boolean operation), etc.</li> </ul>	
I/O port	Total	49	65
	CMOS I/O	42 (N-ch O.D. I/O [ $V_{DD}$ withstand voltage]: 12)	58 (N-ch O.D. I/O [ $V_{DD}$ withstand voltage]: 18)
	CMOS input	5	5
	CMOS output	–	–
	N-ch O.D I/O (withstand voltage: 6 V)	2	2
Timer	16-bit timer TAU	8 channels	
	16-bit timer KB20	1 channel	
	Watchdog timer	1 channel	
	12-bit interval timer (IT)	1 channel	
	Real-time clock 2	1 channel	
	RTC2 output	1 • 1 Hz (subsystem clock: $f_{SUB} = 32.768$ kHz)	
	Timer output	8 channels (PWM outputs: 7 <sup>Note 2</sup> ) (TAU used) 1 channel (timer KB20 used)	
	Remote control output function	1 (TAU used)	

**Notes 1.** In the case of the 8 KB, this is about 7 KB when the self-programming function and data flash function are used.

**2.** The number of outputs varies depending on the setting of the channels in use and the number of master channels (see **6.9.3 Operation as multiple PWM output function** in the RL78/L13 User's Manual.).

(2/2)

Item	64-pin		80-pin	
	R5F10WLx (x = A, C-G)		R5F10WMx (x = A, C-G)	
Clock output/buzzer output controller	2			
	<ul style="list-style-type: none"> <li>• 2.44 kHz, 4.88 kHz, 9.76 kHz, 1.25 MHz, 2.5 MHz, 5 MHz, 10 MHz (Main system clock: <math>f_{MAIN} = 20</math> MHz operation)</li> <li>• 256 Hz, 512 Hz, 1.024 kHz, 2.048 kHz, 4.096 kHz, 8.192 kHz, 16.384 kHz, 32.768 kHz (Subsystem clock: <math>f_{SUB} = 32.768</math> kHz operation)</li> </ul>			
8/10-bit resolution A/D converter	9 channels		12 channels	
Comparator	2 channels			
Serial interface	[64-pin]			
	<ul style="list-style-type: none"> <li>• CSI: 1 channel/UART (UART supporting LIN-bus): 1 channel/simplified I<sup>2</sup>C: 1 channel</li> <li>• CSI: 1 channel/UART: 1 channel/simplified I<sup>2</sup>C: 1 channel</li> <li>• UART: 1 channel</li> </ul>			
I <sup>2</sup> C bus	[80-pin]			
	<ul style="list-style-type: none"> <li>• CSI: 1 channel/UART (UART supporting LIN-bus): 1 channel/simplified I<sup>2</sup>C: 1 channel</li> <li>• CSI: 1 channel/UART: 1 channel/simplified I<sup>2</sup>C: 1 channel</li> <li>• UART: 2 channels</li> </ul>			
LCD controller/driver	Internal voltage boosting method, capacitor split method, and external resistance division method are switchable.			
Segment signal output	36 (32) <sup>Note 1</sup>		51 (47) <sup>Note 1</sup>	
Common signal output	4 (8) <sup>Note 1</sup>			
Multiplier and divider/multiply-accumulator	<ul style="list-style-type: none"> <li>• 16 bits × 16 bits = 32 bits (Unsigned or signed)</li> <li>• 32 bits ÷ 32 bits = 32 bits (Unsigned)</li> <li>• 16 bits × 16 bits + 32 bits = 32 bits (Unsigned or signed)</li> </ul>			
DMA controller	4 channels			
Vectored interrupt sources	Internal	32		35
	External	11		11
Key interrupt	5		8	
Reset	<ul style="list-style-type: none"> <li>• Reset by RESET pin</li> <li>• Internal reset by watchdog timer</li> <li>• Internal reset by power-on-reset</li> <li>• Internal reset by voltage detector</li> <li>• Internal reset by illegal instruction execution<sup>Note 2</sup></li> <li>• Internal reset by RAM parity error</li> <li>• Internal reset by illegal-memory access</li> </ul>			
Power-on-reset circuit	<ul style="list-style-type: none"> <li>• Power-on-reset: 1.51 V (TYP.)</li> <li>• Power-down-reset: 1.50 V (TYP.)</li> </ul>			
Voltage detector	<ul style="list-style-type: none"> <li>• Rising edge: 1.67 V to 4.06 V (14 steps)</li> <li>• Falling edge: 1.63 V to 3.98 V (14 steps)</li> </ul>			
On-chip debug function	Provided			
Power supply voltage	$V_{DD} = 1.6$ to $5.5$ V (TA = -40 to +85°C) $V_{DD} = 2.4$ to $5.5$ V (TA = -40 to +105°C)			
Operating ambient temperature	Consumer applications: TA = -40 to +85°C Industrial applications: TA = -40 to +105°C			

**Notes 1.** The values in parentheses are the number of signal outputs when 8 com is used.

**2.** This reset occurs when instruction code FFH is executed.

This reset does not occur during emulation using an in-circuit emulator or an on-chip debugging emulator.

## 2. ELECTRICAL SPECIFICATIONS ( $T_A = -40$ to $+85^\circ\text{C}$ )

Target products A: Consumer applications;  $T_A = -40$  to  $+85^\circ\text{C}$

R5F10WLAAFA, R5F10WLCAFA, R5F10WLDAFA,  
R5F10WLEAFA, R5F10WLFAFA, R5F10WLGAFB,  
R5F10WLAAFB, R5F10WLCAFB, R5F10WLDAFB,  
R5F10WLEAFB, R5F10WLFAFB, R5F10WLGAFB,  
R5F10WMAAFA, R5F10WMCAFA, R5F10WMDAFA,  
R5F10WMEAFA, R5F10WMFAFA, R5F10WMGAFB,  
R5F10WMAAFB, R5F10WMCAFB, R5F10WMDAFB,  
R5F10WMEAFB, R5F10WMFAFB, R5F10WMGAFB

G: Industrial applications; when using  $T_A = -40$  to  $+105^\circ\text{C}$  specification products at  $T_A = -40$  to  $+85^\circ\text{C}$

R5F10WLAGFB, R5F10WLCGFB, R5F10WLDGFB,  
R5F10WLEGFB, R5F10WLFGFB, R5F10WLGGFB  
R5F10WMAGFB, R5F10WMCGB, R5F10WMDGFB,  
R5F10WMEGFB, R5F10WMFGFB, R5F10WMGGFB

- Cautions**
1. The RL78 microcontrollers have an on-chip debug function, which is provided for development and evaluation. Do not use the on-chip debug function in products designated for mass production, because the guaranteed number of rewritable times of the flash memory may be exceeded when this function is used, and product reliability therefore cannot be guaranteed. Renesas Electronics is not liable for problems occurring when the on-chip debug function is used.
  2. The pins mounted depend on the product. See 2.1 Port Function to 2.2.1 With functions for each product in the RL78/L13 User's Manual.

## 2.1 Absolute Maximum Ratings

## Absolute Maximum Ratings (1/3)

Parameter	Symbol	Conditions	Ratings	Unit
Supply voltage	V <sub>DD</sub>		-0.5 to +6.5	V
REGC pin input voltage	V <sub>I<sub>REGC</sub></sub>	REGC	-0.3 to +2.8 and -0.3 to V <sub>DD</sub> +0.3 <sup>Note 1</sup>	V
Input voltage	V <sub>I1</sub>	P00 to P07, P10 to P17, P20 to P27, P30 to P35, P40 to P47, P50 to P57, P60, P61, P70 to P77, P121 to P127, P130, P137	-0.3 to V <sub>DD</sub> +0.3 <sup>Note 2</sup>	V
	V <sub>I2</sub>	P60 and P61 (N-ch open-drain)	-0.3 to +6.5	V
	V <sub>I3</sub>	EXCLK, EXCLKS, RESET <sup>¯</sup>	-0.3 to V <sub>DD</sub> +0.3 <sup>Note 2</sup>	V
Output voltage	V <sub>O1</sub>	P00 to P07, P10 to P17, P20 to P27, P30 to P35, P40 to P47, P50 to P57, P60, P61, P70 to P77, P121 to P127, P130, P137	-0.3 to V <sub>DD</sub> +0.3 <sup>Note 2</sup>	V
Analog input voltage	V <sub>AI1</sub>	ANI0, ANI1, ANI16 to ANI26	-0.3 to V <sub>DD</sub> +0.3 and -0.3 to AV <sub>REF(+)</sub> +0.3 <sup>Notes 2, 3</sup>	V

**Notes 1.** Connect the REGC pin to V<sub>SS</sub> via a capacitor (0.47 to 1 μF). This value regulates the absolute maximum rating of the REGC pin. Do not use this pin with voltage applied to it.

**2.** Must be 6.5 V or lower.

**3.** Do not exceed AV<sub>REF(+)</sub> + 0.3 V in case of A/D conversion target pin.

**Caution** Product quality may suffer if the absolute maximum rating is exceeded even momentarily for any parameter. That is, the absolute maximum ratings are rated values at which the product is on the verge of suffering physical damage, and therefore the product must be used under conditions that ensure that the absolute maximum ratings are not exceeded.

**Remarks 1.** Unless specified otherwise, the characteristics of alternate-function pins are the same as those of the port pins.

**2.** AV<sub>REF(+)</sub>: + side reference voltage of the A/D converter.

**3.** V<sub>SS</sub>: Reference voltage

**Absolute Maximum Ratings (2/3)**

Parameter	Symbol	Conditions	Ratings	Unit	
LCD voltage	V <sub>L1</sub>	V <sub>L1</sub> voltage <sup>Note 1</sup>	-0.3 to +2.8 and -0.3 to V <sub>L4</sub> +0.3	V	
	V <sub>L2</sub>	V <sub>L2</sub> voltage <sup>Note 1</sup>	-0.3 to V <sub>L4</sub> +0.3 <sup>Note 2</sup>	V	
	V <sub>L3</sub>	V <sub>L3</sub> voltage <sup>Note 1</sup>	-0.3 to V <sub>L4</sub> +0.3 <sup>Note 2</sup>	V	
	V <sub>L4</sub>	V <sub>L4</sub> voltage <sup>Note 1</sup>	-0.3 to +6.5	V	
	V <sub>LCAP</sub>	CAPL, CAPH voltage <sup>Note 1</sup>	-0.3 to V <sub>L4</sub> +0.3 <sup>Note 2</sup>	V	
	V <sub>OUT</sub>	COM0 to COM7 SEG0 to SEG50 output voltage	External resistance division method	-0.3 to V <sub>DD</sub> +0.3 <sup>Note 2</sup>	V
			Capacitor split method	-0.3 to V <sub>DD</sub> +0.3 <sup>Note 2</sup>	V
Internal voltage boosting method			-0.3 to V <sub>L4</sub> +0.3 <sup>Note 2</sup>	V	

**Notes 1.** This value only indicates the absolute maximum ratings when applying voltage to the V<sub>L1</sub>, V<sub>L2</sub>, V<sub>L3</sub>, and V<sub>L4</sub> pins; it does not mean that applying voltage to these pins is recommended. When using the internal voltage boosting method or capacitance split method, connect these pins to V<sub>SS</sub> via a capacitor (0.47 μF ± 30%) and connect a capacitor (0.47 μF ± 30%) between the CAPL and CAPH pins.

**2.** Must be 6.5 V or lower.

**Caution** Product quality may suffer if the absolute maximum rating is exceeded even momentarily for any parameter. That is, the absolute maximum ratings are rated values at which the product is on the verge of suffering physical damage, and therefore the product must be used under conditions that ensure that the absolute maximum ratings are not exceeded.

**Remark** V<sub>SS</sub>: Reference voltage

**Absolute Maximum Ratings (3/3)**

Parameter	Symbol	Conditions		Ratings	Unit
<R> Output current, high	I <sub>OH1</sub>	Per pin	P00 to P07, P10 to P17, P22 to P27, P30 to P35, P40 to P47, P50 to P57, P60, P61, P70 to P77, P125 to P127, P130	-40	mA
<R>		Total of all pins -170 mA	P00 to P07, P10 to P17, P22 to P27, P30 to P35, P40 to P47, P50 to P57, P60, P61, P70 to P77, P125 to P127, P130	-170	mA
<R>	I <sub>OH2</sub>	Per pin	P20, P21	-0.5	mA
<R>		Total of all pins		-1	mA
<R> Output current, low	I <sub>OL1</sub>	Per pin	P00 to P07, P10 to P17, P22 to P27, P30 to P35, P40 to P47, P50 to P57, P60, P61, P70 to P77, P125 to P127, P130	40	mA
<R>		Total of all pins 170 mA	P40 to P47, P130	70	mA
<R>			P00 to P07, P10 to P17, P22 to P27, P30 to P35, P50 to P57, P60, P61, P70 to P77, P125 to P127	100	mA
<R>	I <sub>OL2</sub>	Per pin	P20, P21	1	mA
<R>		Total of all pins		2	mA
Operating ambient temperature	T <sub>A</sub>	In normal operation mode		-40 to +85	°C
		In flash memory programming mode			
Storage temperature	T <sub>stg</sub>			-65 to +150	°C

**Caution** Product quality may suffer if the absolute maximum rating is exceeded even momentarily for any parameter. That is, the absolute maximum ratings are rated values at which the product is on the verge of suffering physical damage, and therefore the product must be used under conditions that ensure that the absolute maximum ratings are not exceeded.

**Remark** Unless specified otherwise, the characteristics of alternate-function pins are the same as those of the port pins.

## 2.2 Oscillator Characteristics

### 2.2.1 X1 and XT1 oscillator characteristics

(T<sub>A</sub> = -40 to +85°C, 1.6 V ≤ V<sub>DD</sub> ≤ 5.5 V, V<sub>SS</sub> = 0 V)

Parameter	Resonator	Conditions	MIN.	TYP.	MAX.	Unit
X1 clock oscillation frequency (f <sub>X</sub> ) <sup>Note</sup>	Ceramic resonator/ crystal resonator	2.7 V ≤ V <sub>DD</sub> ≤ 5.5 V	1.0		20.0	MHz
		2.4 V ≤ V <sub>DD</sub> < 2.7 V	1.0		16.0	
		1.8 V ≤ V <sub>DD</sub> < 2.4 V	1.0		8.0	
		1.6 V ≤ V <sub>DD</sub> < 1.8 V	1.0		4.0	
XT1 clock oscillation frequency (f <sub>XT</sub> ) <sup>Note</sup>	Crystal resonator		32	32.768	35	kHz

**Note** Indicates only permissible oscillator frequency ranges. Refer to **AC Characteristics** for instruction execution time. Request evaluation by the manufacturer of the oscillator circuit mounted on a board to check the oscillator characteristics.

**Caution** Since the CPU is started by the high-speed on-chip oscillator clock after a reset release, check the X1 clock oscillation stabilization time using the oscillation stabilization time counter status register (OSTC) by the user. Determine the oscillation stabilization time of the OSTC register and the oscillation stabilization time select register (OSTS) after sufficiently evaluating the oscillation stabilization time with the resonator to be used.

**Remark** When using the X1 oscillator and XT1 oscillator, see 5.4 System Clock Oscillator in the RL78/L13 User's Manual.

### 2.2.2 On-chip oscillator characteristics

(T<sub>A</sub> = -40 to +85°C, 1.6 V ≤ V<sub>DD</sub> ≤ 5.5 V, V<sub>SS</sub> = 0 V)

Parameter	Symbol	Conditions		MIN.	TYP.	MAX.	Unit
High-speed on-chip oscillator clock frequency <sup>Notes 1, 2</sup>	f <sub>H</sub>			1		24	MHz
High-speed on-chip oscillator clock frequency accuracy		-20 to +85°C	1.8 V ≤ V <sub>DD</sub> ≤ 5.5 V	-1.0		+1.0	%
			1.6 V ≤ V <sub>DD</sub> < 1.8 V	-5.0		+5.0	%
		-40 to -20°C	1.8 V ≤ V <sub>DD</sub> ≤ 5.5 V	-1.5		+1.5	%
			1.6 V ≤ V <sub>DD</sub> < 1.8 V	-5.5		+5.5	%
Low-speed on-chip oscillator clock frequency	f <sub>L</sub>				15		kHz
Low-speed on-chip oscillator clock frequency accuracy				-15		+15	%

**Notes 1.** The high-speed on-chip oscillator frequency is selected by bits 0 to 4 of the option byte (000C2H/010C2H) and bits 0 to 2 of the HOCODIV register.

**2.** This indicates the oscillator characteristics only. Refer to **AC Characteristics** for the instruction execution time.



## 2.3 DC Characteristics

### 2.3.1 Pin characteristics

(T<sub>A</sub> = -40 to +85°C, 1.6 V ≤ V<sub>DD</sub> ≤ 5.5 V, V<sub>SS</sub> = 0 V)

Parameter	Symbol	Conditions	MIN.	TYP.	MAX.	Unit	
Output current, high <sup>Note 1</sup>	I <sub>OH1</sub>	Per pin for P00 to P07, P10 to P17, P22 to P27, P30 to P35, P40 to P47, P50 to P57, P70 to P77, P125 to P127, P130	1.6 V ≤ V <sub>DD</sub> ≤ 5.5 V			-10.0 <sup>Note 2</sup>	mA
		Total of P00 to P07, P10 to P17, P22 to P27, P30 to P35, P40 to P47, P50 to P57, P70 to P77, P125 to P127, P130 (When duty = 70% <sup>Note 3</sup> )	4.0 V ≤ V <sub>DD</sub> ≤ 5.5 V			-90.0	mA
			2.7 V ≤ V <sub>DD</sub> < 4.0 V			-15.0	mA
			1.8 V ≤ V <sub>DD</sub> < 2.7 V			-7.0	mA
	I <sub>OH2</sub>	Per pin for P20 and P21	1.6 V ≤ V <sub>DD</sub> ≤ 5.5 V			-0.1 <sup>Note 2</sup>	mA
		Total of all pins (When duty = 70% <sup>Note 3</sup> )	1.6 V ≤ V <sub>DD</sub> ≤ 5.5 V			-0.2	mA

<R>

- Notes**
- Value of the current at which the device operation is guaranteed even if the current flows from the V<sub>DD</sub> pin to an output pin
  - Do not exceed the total current value.
  - Output current value under conditions where the duty factor ≤ 70%.

The output current value that has changed to the duty factor > 70% the duty ratio can be calculated with the following expression (when changing the duty factor from 70% to n%).

- Total output current of pins = (I<sub>OH</sub> × 0.7)/(n × 0.01)

<Example> Where n = 80% and I<sub>OH</sub> = -90.0 mA

$$\text{Total output current of pins} = (-90.0 \times 0.7) / (80 \times 0.01) \cong -78.75 \text{ mA}$$

However, the current that is allowed to flow into one pin does not vary depending on the duty factor. A current higher than the absolute maximum rating must not flow into one pin.

**Caution** P00, P04 to P07, P16, P17, P35, P42 to P44, P46, P47, P53 to P56, and P130 do not output high level in N-ch open-drain mode.

**Remark** Unless specified otherwise, the characteristics of alternate-function pins are the same as those of the port pins.

(T<sub>A</sub> = -40 to +85°C, 1.6 V ≤ V<sub>DD</sub> ≤ 5.5 V, V<sub>SS</sub> = 0 V)

Parameter	Symbol	Conditions	MIN.	TYP.	MAX.	Unit	
Output current, I <sub>OL</sub> <sup>Note 1</sup>	I <sub>OL1</sub>	Per pin for P00 to P07, P10 to P17, P22 to P27, P30 to P35, P40 to P47, P50 to P57, P70 to P77, P125 to P127, P130			20.0 <sup>Note 2</sup>	mA	
		Per pin for P60 and P61			15.0 <sup>Note 2</sup>	mA	
		Total of P40 to P47, P130 (When duty = 70% <sup>Note 3</sup> )	4.0 V ≤ V <sub>DD</sub> ≤ 5.5 V			70.0	mA
			2.7 V ≤ V <sub>DD</sub> < 4.0 V			15.0	mA
			1.8 V ≤ V <sub>DD</sub> < 2.7 V			9.0	mA
			1.6 V ≤ V <sub>DD</sub> < 1.8 V			4.5	mA
		Total of P00 to P07, P10 to P17, P22 to P27, P30 to P35, P50 to P57, P70 to P77, P125 to P127 (When duty = 70% <sup>Note 3</sup> )	4.0 V ≤ V <sub>DD</sub> ≤ 5.5 V			90.0	mA
			2.7 V ≤ V <sub>DD</sub> < 4.0 V			35.0	mA
			1.8 V ≤ V <sub>DD</sub> < 2.7 V			20.0	mA
			1.6 V ≤ V <sub>DD</sub> < 1.8 V			10.0	mA
	Total of all pins (When duty = 70% <sup>Note 3</sup> )				160.0	mA	
	I <sub>OL2</sub>	Per pin for P20 and P21				0.4 <sup>Note 2</sup>	mA
Total of all pins (When duty = 70% <sup>Note 3</sup> )		1.6 V ≤ V <sub>DD</sub> ≤ 5.5 V			0.8	mA	

<R>

- Notes**
- Value of the current at which the device operation is guaranteed even if the current flows from an output pin to the V<sub>SS</sub> pin
  - Do not exceed the total current value.
  - Output current value under conditions where the duty factor ≤ 70%.  
The output current value that has changed to the duty factor > 70% the duty ratio can be calculated with the following expression (when changing the duty factor from 70% to n%).
    - Total output current of pins = (I<sub>OL</sub> × 0.7)/(n × 0.01)  
<Example> Where n = 80% and I<sub>OL</sub> = 70.0 mA  
Total output current of pins = (70.0 × 0.7)/(80 × 0.01) ≅ 61.25 mA
 However, the current that is allowed to flow into one pin does not vary depending on the duty factor. A current higher than the absolute maximum rating must not flow into one pin.

**Remark** Unless specified otherwise, the characteristics of alternate-function pins are the same as those of the port pins.

( $T_A = -40$  to  $+85^\circ\text{C}$ ,  $1.6\text{ V} \leq V_{DD} \leq 5.5\text{ V}$ ,  $V_{SS} = 0\text{ V}$ )

Parameter	Symbol	Conditions	MIN.	TYP.	MAX.	Unit	
Input voltage, high	$V_{IH1}$	P00 to P07, P10 to P17, P22 to P27, P30 to P35, P40 to P47, P50 to P57, P70 to P77, P125 to P127, P130, P137	Normal input buffer	$0.8V_{DD}$		$V_{DD}$	V
	$V_{IH2}$	P03, P05, P06, P16, P17, P34, P43, P44, P46, P47, P53, P55	TTL input buffer $4.0\text{ V} \leq V_{DD} \leq 5.5\text{ V}$	2.2		$V_{DD}$	V
			TTL input buffer $3.3\text{ V} \leq V_{DD} < 4.0\text{ V}$	2.0		$V_{DD}$	V
			TTL input buffer $1.6\text{ V} \leq V_{DD} < 3.3\text{ V}$	1.5		$V_{DD}$	V
	$V_{IH3}$	P20, P21		$0.7V_{DD}$		$V_{DD}$	V
	$V_{IH4}$	P60, P61		$0.7V_{DD}$		6.0	V
	$V_{IH5}$	P121 to P124, P137, EXCLK, EXCLKS, RESET		$0.8V_{DD}$		$V_{DD}$	V
Input voltage, low	$V_{IL1}$	P00 to P07, P10 to P17, P22 to P27, P30 to P35, P40 to P47, P50 to P57, P70 to P77, P125 to P127, P130, P137	Normal input buffer	0		$0.2V_{DD}$	V
	$V_{IL2}$	P03, P05, P06, P16, P17, P34, P43, P44, P46, P47, P53, P55	TTL input buffer $4.0\text{ V} \leq V_{DD} \leq 5.5\text{ V}$	0		0.8	V
			TTL input buffer $3.3\text{ V} \leq V_{DD} < 4.0\text{ V}$	0		0.5	V
			TTL input buffer $1.6\text{ V} \leq V_{DD} < 3.3\text{ V}$	0		0.32	V
	$V_{IL3}$	P20, P21		0		$0.3V_{DD}$	V
	$V_{IL4}$	P60, P61		0		$0.3V_{DD}$	V
	$V_{IL5}$	P121 to P124, P137, EXCLK, EXCLKS, RESET		0		$0.2V_{DD}$	V

**Caution** The maximum value of  $V_{IH}$  of pins P00, P04 to P07, P16, P17, P35, P42 to P44, P46, P47, P53 to P56, and P130 is  $V_{DD}$ , even in the N-ch open-drain mode.

**Remark** Unless specified otherwise, the characteristics of alternate-function pins are the same as those of the port pins.

(T<sub>A</sub> = -40 to +85°C, 1.6 V ≤ V<sub>DD</sub> ≤ 5.5 V, V<sub>SS</sub> = 0 V)

Parameter	Symbol	Conditions	MIN.	TYP.	MAX.	Unit	
Output voltage, high	V <sub>OH1</sub>	P00 to P07, P10 to P17, P22 to P27, P30 to P35, P40 to P47, P50 to P57, P70 to P77, P125 to P127, P130	4.0 V ≤ V <sub>DD</sub> ≤ 5.5 V, I <sub>OH1</sub> = -10.0 mA	V <sub>DD</sub> - 1.5			V
			4.0 V ≤ V <sub>DD</sub> ≤ 5.5 V, I <sub>OH1</sub> = -3.0 mA	V <sub>DD</sub> - 0.7			V
			2.7 V ≤ V <sub>DD</sub> ≤ 5.5 V, I <sub>OH1</sub> = -2.0 mA	V <sub>DD</sub> - 0.6			V
			1.8 V ≤ V <sub>DD</sub> ≤ 5.5 V, I <sub>OH1</sub> = -1.5 mA	V <sub>DD</sub> - 0.5			V
			1.6 V ≤ V <sub>DD</sub> ≤ 5.5 V, I <sub>OH1</sub> = -1.0 mA	V <sub>DD</sub> - 0.5			V
	V <sub>OH2</sub>	P20 and P21	1.6 V ≤ V <sub>DD</sub> ≤ 5.5 V, I <sub>OH2</sub> = -100 μA	V <sub>DD</sub> - 0.5			V
Output voltage, low	V <sub>OL1</sub>	P00 to P07, P10 to P17, P22 to P27, P30 to P35, P40 to P47, P50 to P57, P70 to P77, P125 to P127, P130	4.0 V ≤ V <sub>DD</sub> ≤ 5.5 V, I <sub>OL1</sub> = 20 mA			1.3	V
			4.0 V ≤ V <sub>DD</sub> ≤ 5.5 V, I <sub>OL1</sub> = 8.5 mA			0.7	V
			2.7 V ≤ V <sub>DD</sub> ≤ 5.5 V, I <sub>OL1</sub> = 3.0 mA			0.6	V
			2.7 V ≤ V <sub>DD</sub> ≤ 5.5 V, I <sub>OL1</sub> = 1.5 mA			0.4	V
			1.8 V ≤ V <sub>DD</sub> ≤ 5.5 V, I <sub>OL1</sub> = 0.6 mA			0.4	V
			1.6 V ≤ V <sub>DD</sub> < 1.8 V, I <sub>OL1</sub> = 0.3 mA			0.4	V
	V <sub>OL2</sub>	P20 and P21	1.6 V ≤ V <sub>DD</sub> ≤ 5.5 V, I <sub>OL2</sub> = 400 μA			0.4	V
	V <sub>OL3</sub>	P60 and P61	4.0 V ≤ V <sub>DD</sub> ≤ 5.5 V, I <sub>OL3</sub> = 15.0 mA			2.0	V
			4.0 V ≤ V <sub>DD</sub> ≤ 5.5 V, I <sub>OL3</sub> = 5.0 mA			0.4	V
			2.7 V ≤ V <sub>DD</sub> ≤ 5.5 V, I <sub>OL3</sub> = 3.0 mA			0.4	V
			1.8 V ≤ V <sub>DD</sub> ≤ 5.5 V, I <sub>OL3</sub> = 2.0 mA			0.4	V
			1.6 V ≤ V <sub>DD</sub> < 1.8 V, I <sub>OL3</sub> = 1.0 mA			0.4	V

**Caution** P00, P04 to P07, P16, P17, P35, P42 to P44, P46, P47, P53 to P56, and P130 do not output high level in N-ch open-drain mode.

**Remark** Unless specified otherwise, the characteristics of alternate-function pins are the same as those of the port pins.

**( $T_A = -40$  to  $+85^\circ\text{C}$ ,  $1.6\text{ V} \leq V_{DD} \leq 5.5\text{ V}$ ,  $V_{SS} = 0\text{ V}$ )**

Parameter	Symbol	Conditions	MIN.	TYP.	MAX.	Unit		
Input leakage current, high	I <sub>LIH1</sub>	P00 to P07, P10 to P17, P22 to P27, P30 to P35, P40 to P47, P50 to P57, P70 to P77, P125 to P127, P130, P137	$V_I = V_{DD}$			1	$\mu\text{A}$	
	I <sub>LIH2</sub>	P20 and P21, $\overline{\text{RESET}}$	$V_I = V_{DD}$			1	$\mu\text{A}$	
	I <sub>LIH3</sub>	P121 to P124 (X1, X2, XT1, XT2, EXCLK, EXCLKS)	$V_I = V_{DD}$	In input port mode and when external clock is input			1	$\mu\text{A}$
				Resonator connected			10	$\mu\text{A}$
Input leakage current, low	I <sub>LIL1</sub>	P00 to P07, P10 to P17, P22 to P27, P30 to P35, P40 to P47, P50 to P57, P70 to P77, P125 to P127, P130, P137	$V_I = V_{SS}$			-1	$\mu\text{A}$	
	I <sub>LIL2</sub>	P20 and P21, $\overline{\text{RESET}}$	$V_I = V_{SS}$			-1	$\mu\text{A}$	
	I <sub>LIL3</sub>	P121 to P124 (X1, X2, XT1, XT2, EXCLK, EXCLKS)	$V_I = V_{SS}$	In input port mode and when external clock is input			-1	$\mu\text{A}$
				Resonator connected			-10	$\mu\text{A}$
On-chip pull-up resistance	R <sub>U1</sub>	P00 to P07, P10 to P17, P22 to P27, P30 to P35, P45 to P47, P50 to P57, P70 to P77, P125 to P127, P130	$V_I = V_{SS}$	$2.4\text{ V} \leq V_{DD} < 5.5\text{ V}$	10	20	100	$\text{k}\Omega$
				$1.6\text{ V} \leq V_{DD} < 2.4\text{ V}$	10	30	100	$\text{k}\Omega$
	R <sub>U2</sub>	P40 to P44	$V_I = V_{SS}$	10	20	100	$\text{k}\Omega$	

**Remark** Unless specified otherwise, the characteristics of alternate-function pins are the same as those of the port pins.

2.3.2 Supply current characteristics

(T<sub>A</sub> = -40 to +85°C, 1.6 V ≤ V<sub>DD</sub> ≤ 5.5 V, V<sub>SS</sub> = 0 V)

(1/2)

Parameter	Symbol	Conditions				MIN.	TYP.	MAX.	Unit	
Supply current <sup>Note 1</sup>	I <sub>DD1</sub>	Operating mode	HS (high-speed main) mode <sup>Note 5</sup>	f <sub>HOCO</sub> = 48 MHz <sup>Note 3</sup> , f <sub>IH</sub> = 24 MHz <sup>Note 3</sup>	Basic operation	V <sub>DD</sub> = 5.0 V		2.0		mA
						V <sub>DD</sub> = 3.0 V		2.0		mA
				Normal operation	V <sub>DD</sub> = 5.0 V		3.8	6.5	mA	
					V <sub>DD</sub> = 3.0 V		3.8	6.5	mA	
				Basic operation	V <sub>DD</sub> = 5.0 V		1.7		mA	
					V <sub>DD</sub> = 3.0 V		1.7		mA	
			Normal operation	V <sub>DD</sub> = 5.0 V		3.6	6.1	mA		
				V <sub>DD</sub> = 3.0 V		3.6	6.1	mA		
			Normal operation	V <sub>DD</sub> = 5.0 V		2.7	4.7	mA		
				V <sub>DD</sub> = 3.0 V		2.7	4.7	mA		
			LS (low-speed main) mode <sup>Note 5</sup>	f <sub>HOCO</sub> = 8 MHz <sup>Note 3</sup> , f <sub>IH</sub> = 8 MHz <sup>Note 3</sup>	Normal operation	V <sub>DD</sub> = 3.0 V		1.2	2.1	mA
						V <sub>DD</sub> = 2.0 V		1.2	2.1	mA
			LV (low-voltage main) mode <sup>Note 5</sup>	f <sub>HOCO</sub> = 4 MHz <sup>Note 3</sup> , f <sub>IH</sub> = 4 MHz <sup>Note 3</sup>	Normal operation	V <sub>DD</sub> = 3.0 V		1.2	1.8	mA
						V <sub>DD</sub> = 2.0 V		1.2	1.8	mA
			HS (high-speed main) mode <sup>Note 5</sup>	f <sub>MX</sub> = 20 MHz <sup>Note 2</sup> , V <sub>DD</sub> = 5.0 V	Normal operation	Square wave input		3.0	5.1	mA
						Resonator connection		3.2	5.2	mA
				f <sub>MX</sub> = 20 MHz <sup>Note 2</sup> , V <sub>DD</sub> = 3.0 V	Normal operation	Square wave input		2.9	5.1	mA
						Resonator connection		3.2	5.2	mA
		f <sub>MX</sub> = 16 MHz <sup>Note 2</sup> , V <sub>DD</sub> = 5.0 V		Normal operation	Square wave input		2.5	4.4	mA	
					Resonator connection		2.7	4.5	mA	
		f <sub>MX</sub> = 16 MHz <sup>Note 2</sup> , V <sub>DD</sub> = 3.0 V		Normal operation	Square wave input		2.5	4.4	mA	
					Resonator connection		2.7	4.5	mA	
		f <sub>MX</sub> = 10 MHz <sup>Note 2</sup> , V <sub>DD</sub> = 5.0 V		Normal operation	Square wave input		1.9	3.0	mA	
					Resonator connection		1.9	3.0	mA	
		f <sub>MX</sub> = 10 MHz <sup>Note 2</sup> , V <sub>DD</sub> = 3.0 V		Normal operation	Square wave input		1.9	3.0	mA	
					Resonator connection		1.9	3.0	mA	
		LS (low-speed main) mode <sup>Note 5</sup>	f <sub>MX</sub> = 8 MHz <sup>Note 2</sup> , V <sub>DD</sub> = 3.0 V	Normal operation	Square wave input		1.1	2.0	mA	
					Resonator connection		1.1	2.0	mA	
			f <sub>MX</sub> = 8 MHz <sup>Note 2</sup> , V <sub>DD</sub> = 2.0 V	Normal operation	Square wave input		1.1	2.0	mA	
					Resonator connection		1.1	2.0	mA	
		Subsystem clock operation	f <sub>SUB</sub> = 32.768 kHz <sup>Note 4</sup> , T <sub>A</sub> = -40°C	Normal operation	Square wave input		4.0	5.4	μA	
					Resonator connection		4.3	5.4	μA	
			f <sub>SUB</sub> = 32.768 kHz <sup>Note 4</sup> , T <sub>A</sub> = +25°C	Normal operation	Square wave input		4.0	5.4	μA	
					Resonator connection		4.3	5.4	μA	
			f <sub>SUB</sub> = 32.768 kHz <sup>Note 4</sup> , T <sub>A</sub> = +50°C	Normal operation	Square wave input		4.1	7.1	μA	
					Resonator connection		4.4	7.1	μA	
f <sub>SUB</sub> = 32.768 kHz <sup>Note 4</sup> , T <sub>A</sub> = +70°C	Normal operation		Square wave input		4.3	8.7	μA			
			Resonator connection		4.7	8.7	μA			
f <sub>SUB</sub> = 32.768 kHz <sup>Note 4</sup> , T <sub>A</sub> = +85°C	Normal operation	Square wave input		4.7	12.0	μA				
		Resonator connection		5.2	12.0	μA				

(Notes and Remarks are listed on the next page.)

- Notes**
1. Total current flowing into V<sub>DD</sub>, including the input leakage current flowing when the level of the input pin is fixed to V<sub>DD</sub> or V<sub>SS</sub>. The values below the MAX. column include the peripheral operation current. However, not including the current flowing into the LCD controller/driver, A/D converter, LVD circuit, comparator, I/O port, on-chip pull-up/pull-down resistors, and the current flowing during data flash rewrite.
  2. When high-speed on-chip oscillator and subsystem clock are stopped.
  3. When high-speed system clock and subsystem clock are stopped.
  4. When high-speed on-chip oscillator and high-speed system clock are stopped. When setting ultra-low power consumption oscillation (AMPHS1 = 1). The current flowing into the LCD controller/driver, 16-bit timer KB20, real-time clock 2, 12-bit interval timer, and watchdog timer is not included.
  5. Relationship between operation voltage width, operation frequency of CPU and operation mode is as below.
    - HS (high-speed main) mode: 2.7 V ≤ V<sub>DD</sub> ≤ 5.5 V@1 MHz to 24 MHz  
2.4 V ≤ V<sub>DD</sub> ≤ 5.5 V@1 MHz to 16 MHz
    - LS (low-speed main) mode: 1.8 V ≤ V<sub>DD</sub> ≤ 5.5 V@1 MHz to 8 MHz
    - LV (low-voltage main) mode: 1.6 V ≤ V<sub>DD</sub> ≤ 5.5 V@1 MHz to 4 MHz

- Remarks**
1. f<sub>MX</sub>: High-speed system clock frequency (X1 clock oscillation frequency or external main system clock frequency)
  2. f<sub>HOCO</sub>: High-speed on-chip oscillator clock frequency (48 MHz max.)
  3. f<sub>IH</sub>: High-speed on-chip oscillator clock frequency (24 MHz max.)
  4. f<sub>SUB</sub>: Subsystem clock frequency (XT1 clock oscillation frequency)
  5. Except subsystem clock operation, temperature condition of the TYP. value is T<sub>A</sub> = 25°C

(T<sub>A</sub> = -40 to +85°C, 1.6 V ≤ V<sub>DD</sub> ≤ 5.5 V, V<sub>SS</sub> = 0 V)

(2/2)

Parameter	Symbol	Conditions				MIN.	TYP.	MAX.	Unit
Supply current <sup>Note 1</sup>	I <sub>DD2</sub> <sup>Note 2</sup>	HALT mode	HS (high-speed main) mode <sup>Note 7</sup>	f <sub>HOCO</sub> = 48 MHz <sup>Note 4</sup> , f <sub>IH</sub> = 24 MHz <sup>Note 4</sup>	V <sub>DD</sub> = 5.0 V		0.71	1.95	mA
					V <sub>DD</sub> = 3.0 V		0.71	1.95	
				f <sub>HOCO</sub> = 24 MHz <sup>Note 4</sup> , f <sub>IH</sub> = 24 MHz <sup>Note 4</sup>	V <sub>DD</sub> = 5.0 V		0.49	1.64	mA
					V <sub>DD</sub> = 3.0 V		0.49	1.64	
				f <sub>HOCO</sub> = 16 MHz <sup>Note 4</sup> , f <sub>IH</sub> = 16 MHz <sup>Note 4</sup>	V <sub>DD</sub> = 5.0 V		0.43	1.11	mA
					V <sub>DD</sub> = 3.0 V		0.43	1.11	
			LS (low-speed main) mode <sup>Note 7</sup>	f <sub>HOCO</sub> = 8 MHz <sup>Note 4</sup> , f <sub>IH</sub> = 8 MHz <sup>Note 4</sup>	V <sub>DD</sub> = 3.0 V		280	770	μA
					V <sub>DD</sub> = 2.0 V		280	770	
			LV (low-voltage main) mode <sup>Note 7</sup>	f <sub>HOCO</sub> = 4 MHz <sup>Note 4</sup> , f <sub>IH</sub> = 4 MHz <sup>Note 4</sup>	V <sub>DD</sub> = 3.0 V		430	700	μA
					V <sub>DD</sub> = 2.0 V		430	700	
			HS (high-speed main) mode <sup>Note 7</sup>	f <sub>MX</sub> = 20 MHz <sup>Note 3</sup> , V <sub>DD</sub> = 5.0 V	Square wave input		0.31	1.42	mA
						Resonator connection		0.48	
		Square wave input				0.29	1.42	mA	
					Resonator connection		0.48		1.42
		f <sub>MX</sub> = 16 MHz <sup>Note 3</sup> , V <sub>DD</sub> = 5.0 V			Square wave input		0.26	0.86	mA
						Resonator connection		0.45	
		f <sub>MX</sub> = 16 MHz <sup>Note 3</sup> , V <sub>DD</sub> = 3.0 V			Square wave input		0.25	0.86	mA
						Resonator connection		0.44	
		f <sub>MX</sub> = 10 MHz <sup>Note 3</sup> , V <sub>DD</sub> = 5.0 V			Square wave input		0.20	0.63	mA
						Resonator connection		0.28	
		f <sub>MX</sub> = 10 MHz <sup>Note 3</sup> , V <sub>DD</sub> = 3.0 V			Square wave input		0.19	0.63	mA
						Resonator connection		0.28	
		LS (low-speed main) mode <sup>Note 7</sup>	f <sub>MX</sub> = 8 MHz <sup>Note 3</sup> , V <sub>DD</sub> = 3.0 V	Square wave input		100	560	μA	
					Resonator connection		160		560
Square wave input				100	560	μA			
	Resonator connection				160		560		
Subsystem clock operation	f <sub>SUB</sub> = 32.768 kHz <sup>Note 5</sup>	Square wave input	T <sub>A</sub> = -40°C		0.34	0.62	μA		
			Resonator connection		0.51	0.80			
		Square wave input	T <sub>A</sub> = +25°C		0.38	0.62	μA		
			Resonator connection		0.57	0.80			
		Square wave input	T <sub>A</sub> = +50°C		0.46	2.30	μA		
			Resonator connection		0.67	2.49			
		Square wave input	T <sub>A</sub> = +70°C		0.65	4.03	μA		
			Resonator connection		0.91	4.22			
		Square wave input	T <sub>A</sub> = +85°C		1.00	8.04	μA		
			Resonator connection		1.31	8.23			
I <sub>DD3</sub> <sup>Note 6</sup>	STOP mode <sup>Note 8</sup>	T <sub>A</sub> = -40°C				0.18	0.52	μA	
		T <sub>A</sub> = +25°C				0.24	0.52		
		T <sub>A</sub> = +50°C				0.33	2.21		
		T <sub>A</sub> = +70°C				0.53	3.94		
		T <sub>A</sub> = +85°C				0.93	7.95		

(Notes and Remarks are listed on the next page.)



- Notes**
1. Total current flowing into V<sub>DD</sub>, including the input leakage current flowing when the level of the input pin is fixed to V<sub>DD</sub> or V<sub>SS</sub>. The values below the MAX. column include the peripheral operation current. However, not including the current flowing into the LCD controller/driver, A/D converter, LVD circuit, comparator, I/O port, on-chip pull-up/pull-down resistors, and the current flowing during data flash rewrite.
  2. During HALT instruction execution by flash memory.
  3. When high-speed on-chip oscillator and subsystem clock are stopped.
  4. When high-speed system clock and subsystem clock are stopped.
  5. When high-speed on-chip oscillator and high-speed system clock are stopped.  
When RTCLPC = 1 and setting ultra-low current consumption (AMPHS1 = 1). The current flowing into the real-time clock 2 is included. However, not including the current flowing into the clock output/buzzer output, 12-bit interval timer, and watchdog timer.
  6. Not including the current flowing into the real-time clock 2, clock output/buzzer output, 12-bit interval timer, and watchdog timer.
  7. Relationship between operation voltage width, operation frequency of CPU and operation mode is as below.  
 HS (high-speed main) mode:  $2.7\text{ V} \leq V_{\text{DD}} \leq 5.5\text{ V}@1\text{ MHz to }24\text{ MHz}$   
 $2.4\text{ V} \leq V_{\text{DD}} \leq 5.5\text{ V}@1\text{ MHz to }16\text{ MHz}$   
 LS (low-speed main) mode:  $1.8\text{ V} \leq V_{\text{DD}} \leq 5.5\text{ V}@1\text{ MHz to }8\text{ MHz}$   
 LV (low-voltage main) mode:  $1.6\text{ V} \leq V_{\text{DD}} \leq 5.5\text{ V}@1\text{ MHz to }4\text{ MHz}$
  8. Regarding the value for current to operate the subsystem clock in STOP mode, refer to that in HALT mode.

- Remarks**
1. f<sub>MX</sub>: High-speed system clock frequency (X1 clock oscillation frequency or external main system clock frequency)
  2. f<sub>HOCO</sub>: High-speed on-chip oscillator clock frequency (48 MHz max.)
  3. f<sub>IH</sub>: High-speed on-chip oscillator clock frequency (24 MHz max.)
  4. f<sub>SUB</sub>: Subsystem clock frequency (XT1 clock oscillation frequency)
  5. Except subsystem clock operation and STOP mode, temperature condition of the TYP. value is T<sub>A</sub> = 25°C

(T<sub>A</sub> = -40 to +85°C, 1.6 V ≤ V<sub>DD</sub> ≤ 5.5 V, V<sub>SS</sub> = 0 V)

Parameter	Symbol	Conditions			MIN.	TYP.	MAX.	Unit	
Low-speed on-chip oscillator operating current	I <sub>FIL</sub> <sup>Note 1</sup>					0.20		μA	
RTC2 operating current	I <sub>RTC</sub> <sup>Notes 1, 2, 3</sup>	f <sub>SUB</sub> = 32.768 kHz				0.02		μA	
12-bit interval timer operating current	I <sub>TMKA</sub> <sup>Notes 1, 2, 4</sup>					0.04		μA	
Watchdog timer operating current	I <sub>WDT</sub> <sup>Notes 1, 2, 5</sup>	f <sub>IL</sub> = 15 kHz				0.22		μA	
A/D converter operating current	I <sub>ADC</sub> <sup>Notes 1, 6</sup>	When conversion at maximum speed	Normal mode, AV <sub>REFP</sub> = V <sub>DD</sub> = 5.0 V			1.3	1.7	mA	
			Low voltage mode, AV <sub>REFP</sub> = V <sub>DD</sub> = 3.0 V			0.5	0.7	mA	
A/D converter reference voltage current	I <sub>ADREF</sub> <sup>Note 1</sup>					75.0		μA	
Temperature sensor operating current	I <sub>TMPS</sub> <sup>Note 1</sup>					75.0		μA	
LVD operating current	I <sub>LVD</sub> <sup>Notes 1, 7</sup>					0.08		μA	
Comparator operating current	I <sub>CMP</sub> <sup>Notes 1, 11</sup>	V <sub>DD</sub> = 5.0 V, Regulator output voltage = 2.1 V	Window mode			12.5		μA	
			Comparator high-speed mode			6.5		μA	
			Comparator low-speed mode			1.7		μA	
		V <sub>DD</sub> = 5.0 V, Regulator output voltage = 1.8 V	Window mode			8.0		μA	
			Comparator high-speed mode			4.0		μA	
			Comparator low-speed mode			1.3		μA	
Self-programming operating current	I <sub>FSP</sub> <sup>Notes 1, 9</sup>					2.00	12.20	mA	
BGO operating current	I <sub>BGO</sub> <sup>Notes 1, 8</sup>					2.00	12.20	mA	
SNOOZE operating current	I <sub>SNOZ</sub> <sup>Note 1</sup>	ADC operation	While the mode is shifting <sup>Note 10</sup>			0.50	0.60	mA	
			During A/D conversion, in low voltage mode, AV <sub>REFP</sub> = V <sub>DD</sub> = 3.0 V			1.20	1.44	mA	
		CSI/UART operation			0.70	0.84	mA		
LCD operating current	I <sub>LCD1</sub> <sup>Notes 1, 12, 13</sup>	External resistance division method	f <sub>LCD</sub> = f <sub>SUB</sub>	1/3 bias, four time slices	V <sub>DD</sub> = 5.0 V, V <sub>L4</sub> = 5.0 V		0.04	0.20	μA
			LCD clock = 128 Hz						
	I <sub>LCD2</sub> <sup>Note 1, 12</sup>	Internal voltage boosting method	f <sub>LCD</sub> = f <sub>SUB</sub>	1/3 bias, four time slices	V <sub>DD</sub> = 3.0 V, V <sub>L4</sub> = 3.0 V (V <sub>LCD</sub> = 04H)		0.85	2.20	μA
			LCD clock = 128 Hz		V <sub>DD</sub> = 5.0 V, V <sub>L4</sub> = 5.1 V (V <sub>LCD</sub> = 12H)		1.55	3.70	μA
I <sub>LCD3</sub> <sup>Note 1, 12</sup>	Capacitor split method	f <sub>LCD</sub> = f <sub>SUB</sub>	1/3 bias, four time slices	V <sub>DD</sub> = 3.0 V, V <sub>L4</sub> = 3.0 V		0.20	0.50	μA	
		LCD clock = 128 Hz							

(Notes and Remarks are listed on the next page.)

- Notes**
1. Current flowing to V<sub>DD</sub>.
  2. When high speed on-chip oscillator and high-speed system clock are stopped.
  3. Current flowing only to the real-time clock 2 (excluding the operating current of the low-speed on-chip oscillator and the XT1 oscillator). The value of the current for the RL78 microcontrollers is the sum of the values of either I<sub>DD1</sub> or I<sub>DD2</sub>, and I<sub>RTC</sub>, when the real-time clock 2 operates in operation mode or HALT mode. When the low-speed on-chip oscillator is selected, I<sub>FIL</sub> should be added. I<sub>DD2</sub> subsystem clock operation includes the operational current of real-time clock 2.
  4. Current flowing only to the 12-bit interval timer (excluding the operating current of the low-speed on-chip oscillator and the XT1 oscillator). The value of the current for the RL78 microcontrollers is the sum of the values of either I<sub>DD1</sub> or I<sub>DD2</sub>, and I<sub>TMKA</sub>, when the 12-bit interval timer operates in operation mode or HALT mode. When the low-speed on-chip oscillator is selected, I<sub>FIL</sub> should be added.
  5. Current flowing only to the watchdog timer (including the operating current of the low-speed on-chip oscillator). The current value of the RL78 microcontrollers is the sum of I<sub>DD1</sub>, I<sub>DD2</sub> or I<sub>DD3</sub> and I<sub>WDT</sub> when the watchdog timer operates.
  6. Current flowing only to the A/D converter. The current value of the RL78 microcontrollers is the sum of I<sub>DD1</sub> or I<sub>DD2</sub> and I<sub>ADC</sub> when the A/D converter operates in an operation mode or the HALT mode.
  7. Current flowing only to the LVD circuit. The current value of the RL78 microcontrollers is the sum of I<sub>DD1</sub>, I<sub>DD2</sub> or I<sub>DD3</sub> and I<sub>LVD</sub> when the LVD circuit operates.
  8. Current flowing only during data flash rewrite.
  9. Current flowing only during self programming.
  10. **For shift time to the SNOOZE mode, see 21.3.3 SNOOZE mode** in the RL78/L13 User's Manual.
  11. Current flowing only to the comparator circuit. The current value of the RL78 microcontrollers is the sum of I<sub>DD1</sub>, I<sub>DD2</sub> or I<sub>DD3</sub> and I<sub>COMP</sub> when the comparator circuit operates.
  12. Current flowing only to the LCD controller/driver. The value of the current for the RL78 microcontrollers is the sum of the supply current (I<sub>DD1</sub> or I<sub>DD2</sub>) and LCD operating current (I<sub>LCD1</sub>, I<sub>LCD2</sub>, or I<sub>LCD3</sub>), when the LCD controller/driver operates in operation mode or HALT mode. However, not including the current flowing into the LCD panel. Conditions of the TYP. value and MAX. value are as follows.
    - Setting 20 pins as the segment function and blinking all
    - Selecting f<sub>SUB</sub> for system clock when LCD clock = 128 Hz (LCDC0 = 07H)
    - Setting four time slices and 1/3 bias
  13. Not including the current flowing into the external division resistor when using the external resistance division method.

- Remarks**
1. f<sub>IL</sub>: Low-speed on-chip oscillator clock frequency
  2. f<sub>SUB</sub>: Subsystem clock frequency (XT1 clock oscillation frequency)
  3. f<sub>CLK</sub>: CPU/peripheral hardware clock frequency
  4. The temperature condition for the TYP. value is T<sub>A</sub> = 25°C.

## 2.4 AC Characteristics

(T<sub>A</sub> = -40 to +85°C, 1.6 V ≤ V<sub>DD</sub> ≤ 5.5 V, V<sub>SS</sub> = 0 V)

Parameter	Symbol	Conditions		MIN.	TYP.	MAX.	Unit
Instruction cycle (minimum instruction execution time)	T <sub>CY</sub>	Main system clock (f <sub>MAIN</sub> ) operation	HS (high-speed main) mode	2.7 V ≤ V <sub>DD</sub> ≤ 5.5 V	0.0417	1	μs
				2.4 V ≤ V <sub>DD</sub> < 2.7 V	0.0625	1	μs
			LS (low-speed main) mode	1.8 V ≤ V <sub>DD</sub> ≤ 5.5 V	0.125	1	μs
				LV (low-voltage main) mode	1.6 V ≤ V <sub>DD</sub> ≤ 5.5 V	0.25	1
	Subsystem clock (f <sub>SUB</sub> ) operation <sup>Note</sup>		1.8 V ≤ V <sub>DD</sub> ≤ 5.5 V	28.5	30.5	31.3	μs
	In the self programming mode	HS (high-speed main) mode	2.7 V ≤ V <sub>DD</sub> ≤ 5.5 V	0.0417	1	μs	
			2.4 V ≤ V <sub>DD</sub> < 2.7 V	0.0625	1	μs	
		LS (low-speed main) mode	1.8 V ≤ V <sub>DD</sub> ≤ 5.5 V	0.125	1	μs	
LV (low-voltage main) mode			1.8 V ≤ V <sub>DD</sub> ≤ 5.5 V	0.25	1	μs	
External system clock frequency	f <sub>EX</sub>	2.7 V ≤ V <sub>DD</sub> ≤ 5.5 V		1.0		20.0	MHz
		2.4 V ≤ V <sub>DD</sub> < 2.7 V		1.0		16.0	MHz
		1.8 V ≤ V <sub>DD</sub> < 2.4 V		1.0		8.0	MHz
		1.6 V ≤ V <sub>DD</sub> < 1.8 V		1.0		4.0	MHz
	f <sub>EXS</sub>			32		35	kHz
External system clock input high-level width, low-level width	t <sub>EXH</sub> , t <sub>EXL</sub>	2.7 V ≤ V <sub>DD</sub> ≤ 5.5 V		24			ns
		2.4 V ≤ V <sub>DD</sub> < 2.7 V		30			ns
		1.8 V ≤ V <sub>DD</sub> < 2.4 V		60			ns
		1.6 V ≤ V <sub>DD</sub> < 1.8 V		120			ns
	t <sub>EXHS</sub> , t <sub>EXLS</sub>			13.7			μs
TI00 to TI07 input high-level width, low-level width	t <sub>TIH</sub> , t <sub>TIL</sub>			1/f <sub>MCK</sub> +10			ns
TO00 to TO07, TKBO00, TKBO01-0 to TKBO01-2 output frequency	f <sub>TO</sub>	HS (high-speed main) mode	4.0 V ≤ V <sub>DD</sub> ≤ 5.5 V			12	MHz
			2.7 V ≤ V <sub>DD</sub> < 4.0 V			8	MHz
			2.4 V ≤ V <sub>DD</sub> < 2.7 V			4	MHz
		LV (low-voltage main) mode	1.6 V ≤ V <sub>DD</sub> ≤ 5.5 V			2	MHz
LS (low-speed main) mode	1.8 V ≤ V <sub>DD</sub> ≤ 5.5 V			4	MHz		
PCLBUZ0, PCLBUZ1 output frequency	f <sub>PCL</sub>	HS (high-speed main) mode	4.0 V ≤ V <sub>DD</sub> ≤ 5.5 V			16	MHz
			2.7 V ≤ V <sub>DD</sub> < 4.0 V			8	MHz
			2.4 V ≤ V <sub>DD</sub> < 2.7 V			4	MHz
		LV (low-voltage main) mode	1.8 V ≤ V <sub>DD</sub> ≤ 5.5 V			4	MHz
			1.6 V ≤ V <sub>DD</sub> < 1.8 V			2	MHz
LS (low-speed main) mode	1.8 V ≤ V <sub>DD</sub> ≤ 5.5 V			4	MHz		
Interrupt input high-level width, low-level width	t <sub>INTH</sub> , t <sub>INTL</sub>	INTP0 to INTP7		1.6 V ≤ V <sub>DD</sub> ≤ 5.5 V	1		μs
		Key interrupt input high-level width, low-level width	KR0 to KR7	1.8 V ≤ V <sub>DD</sub> ≤ 5.5 V	250		ns
1.6 V ≤ V <sub>DD</sub> < 1.8 V	1				μs		
IH-PWM output restart input high-level width	t <sub>IHR</sub>	INTP0 to INTP7			2		f <sub>CLK</sub>
TMKB2 forced output stop input high-level width	t <sub>IHR</sub>	INTP0 to INTP2			2		f <sub>CLK</sub>
RESET low-level width	t <sub>RSL</sub>			10			μs

(Note and Remark are listed on the next page.)

**Note** Operation is not possible if  $1.6\text{ V} \leq V_{DD} < 1.8\text{ V}$  in LV (low-voltage main) mode while the system is operating on the subsystem clock.

**Remark**  $f_{MCK}$ : Timer array unit operation clock frequency  
 (Operation clock to be set by the CKSmn0, CKSmn1 bits of timer mode register mn (TMRmn)  
 m: Unit number (m = 0), n: Channel number (n = 0 to 7))

**Minimum Instruction Execution Time during Main System Clock Operation**

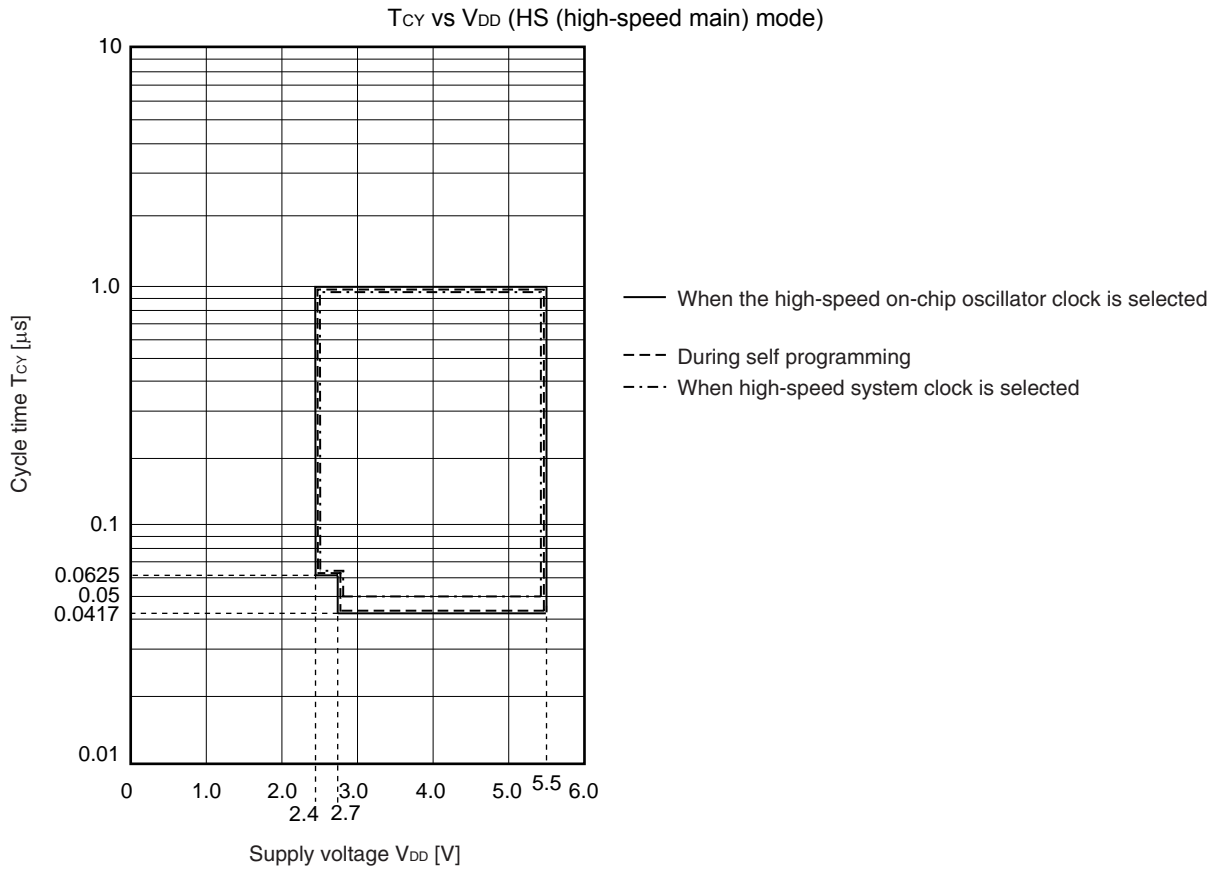

T<sub>CY</sub> vs V<sub>DD</sub> (LS (low-speed main) mode)

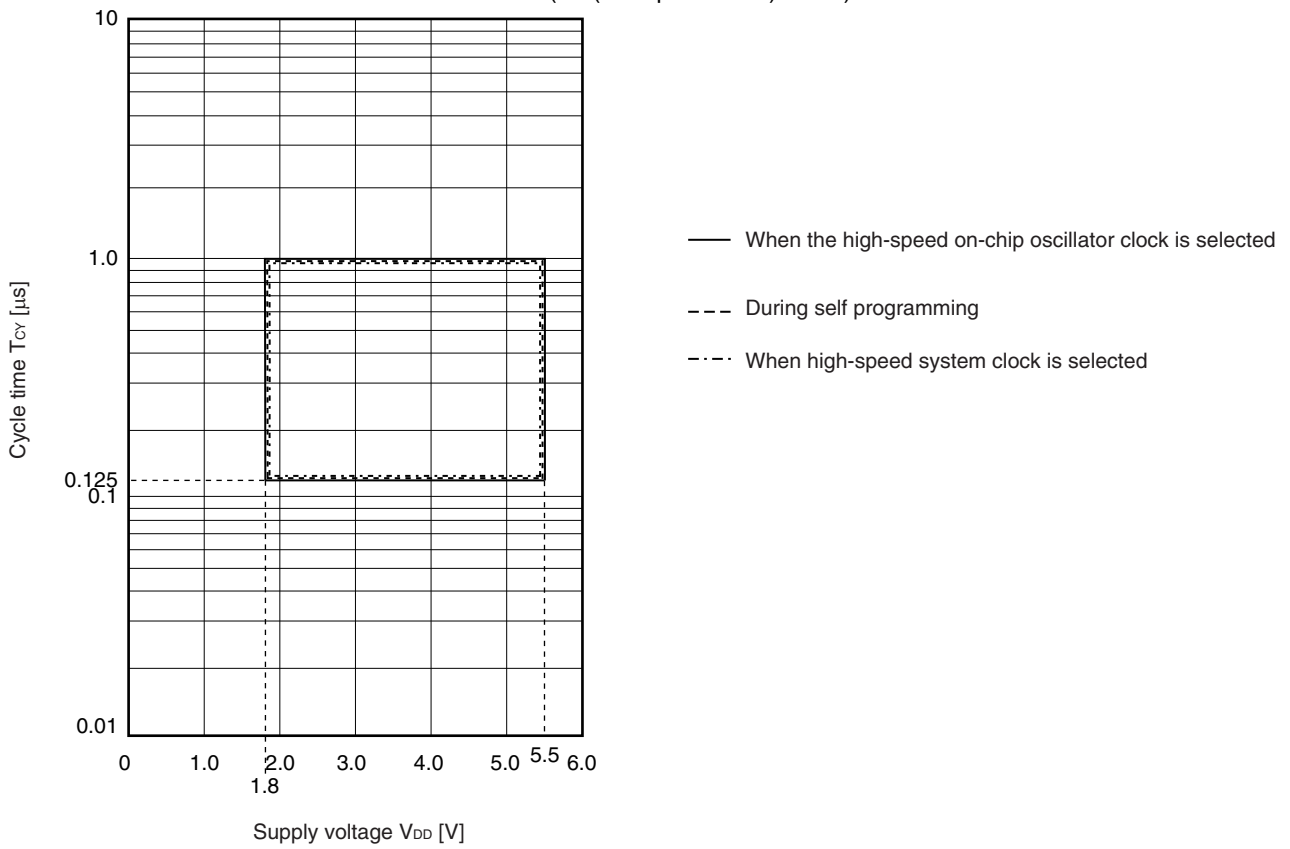

T<sub>CY</sub> vs V<sub>DD</sub> (LV (low-voltage main) mode)

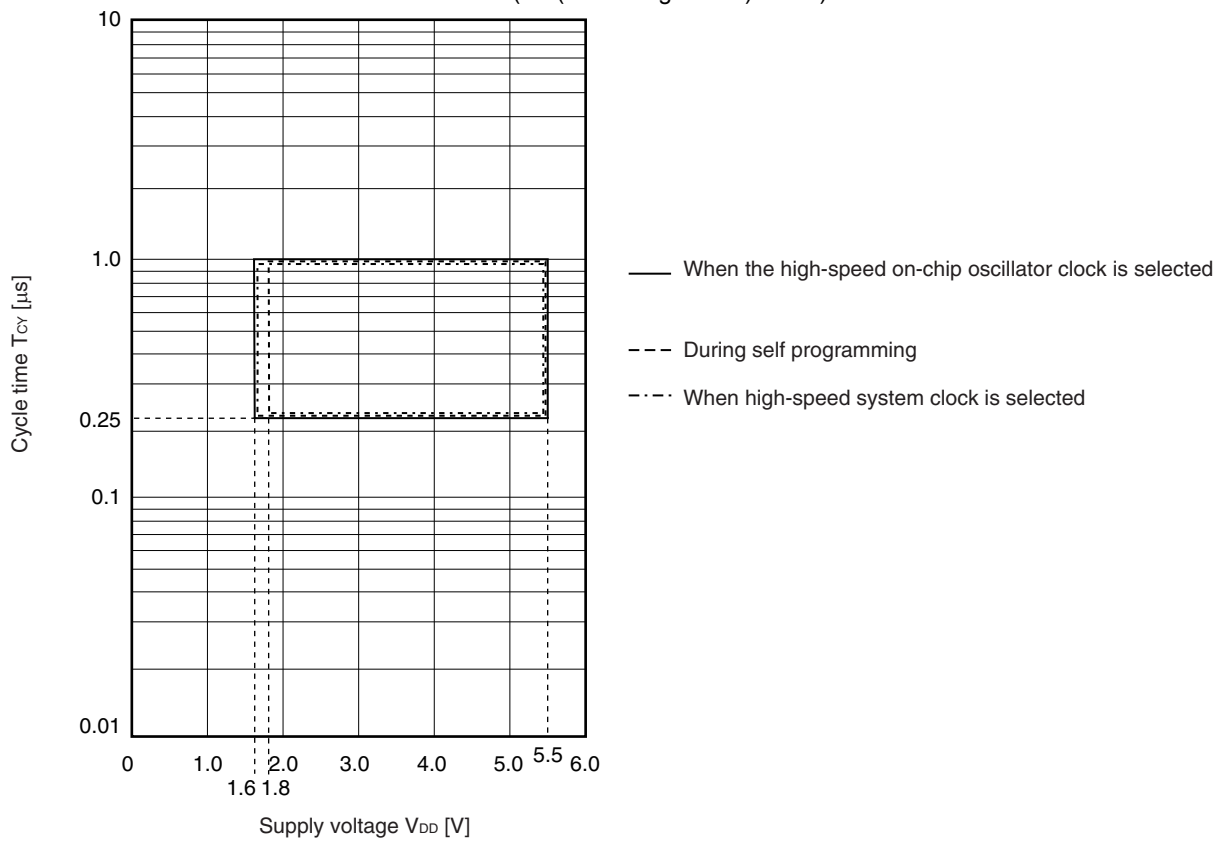

**AC Timing Test Points**

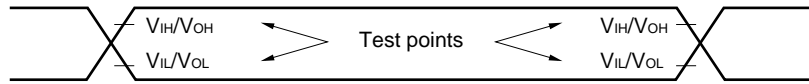

**External System Clock Timing**

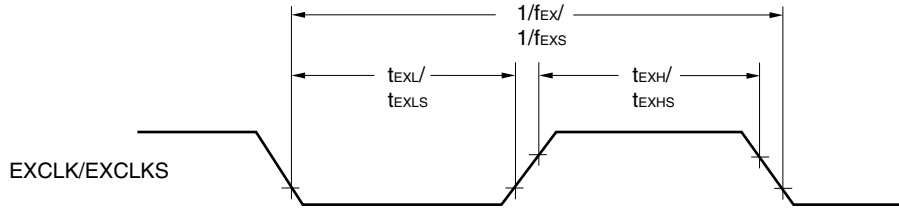

**TI/TO Timing**

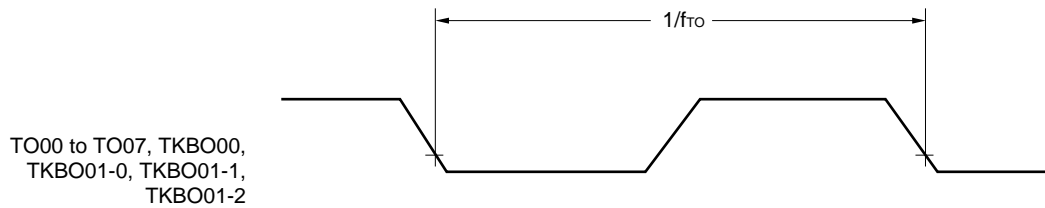
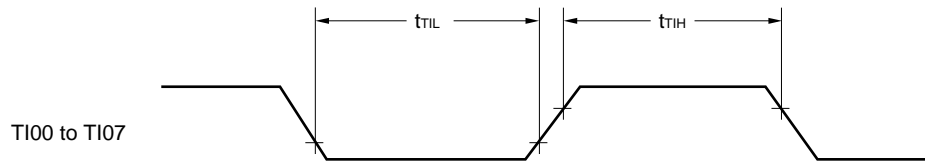

**Interrupt Request Input Timing**

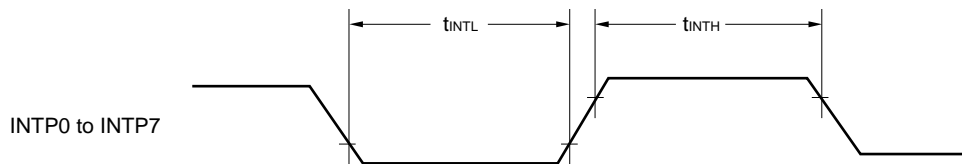

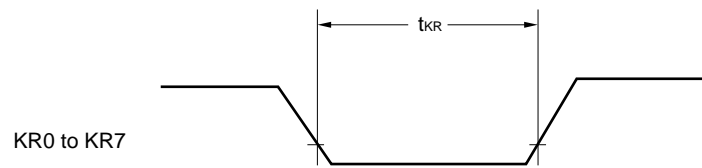
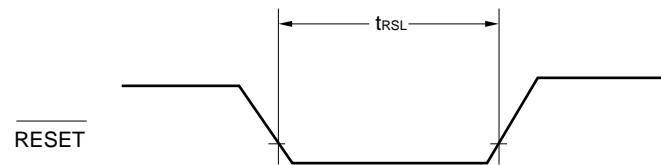
**Key Interrupt Input Timing** **$\overline{\text{RESET}}$  Input Timing**



## 2.5 Peripheral Functions Characteristics

### AC Timing Test Points

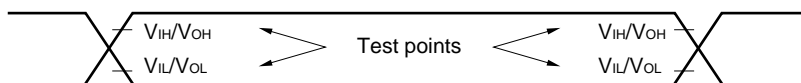

### 2.5.1 Serial array unit

#### (1) During communication at same potential (UART mode)

(T<sub>A</sub> = -40 to +85°C, 1.6 V ≤ V<sub>DD</sub> ≤ 5.5 V, V<sub>SS</sub> = 0 V)

Parameter	Symbol	Conditions	HS (high-speed main) Mode		LS (low-speed main) Mode		LV (low-voltage main) Mode		Unit
			MIN.	MAX.	MIN.	MAX.	MIN.	MAX.	
Transfer rate <sup>Note 1</sup>		2.4 V ≤ V <sub>DD</sub> ≤ 5.5 V		f <sub>MCK</sub> /6		f <sub>MCK</sub> /6		f <sub>MCK</sub> /6	bps
		Theoretical value of the maximum transfer rate f <sub>MCK</sub> = f <sub>CLK</sub> <sup>Note 2</sup>		4.0		1.3		0.6	Mbps
		1.8 V ≤ V <sub>DD</sub> ≤ 5.5 V		–		f <sub>MCK</sub> /6		f <sub>MCK</sub> /6	bps
		Theoretical value of the maximum transfer rate f <sub>MCK</sub> = f <sub>CLK</sub> <sup>Note 2</sup>		–		1.3		0.6	Mbps
		1.6 V ≤ V <sub>DD</sub> ≤ 5.5 V		–		–		f <sub>MCK</sub> /6	bps
		Theoretical value of the maximum transfer rate f <sub>MCK</sub> = f <sub>CLK</sub> <sup>Note 2</sup>		–		–		0.6	Mbps

**Notes 1.** Transfer rate in the SNOOZE mode is 4800 bps only.

**2.** The maximum operating frequencies of the CPU/peripheral hardware clock (f<sub>CLK</sub>) are:

- HS (high-speed main) mode: 24 MHz (2.7 V ≤ V<sub>DD</sub> ≤ 5.5 V)  
16 MHz (2.4 V ≤ V<sub>DD</sub> ≤ 5.5 V)
- LS (low-speed main) mode: 8 MHz (1.8 V ≤ V<sub>DD</sub> ≤ 5.5 V)
- LV (low-voltage main) mode: 4 MHz (1.6 V ≤ V<sub>DD</sub> ≤ 5.5 V)

**Caution** Select the normal input buffer for the RxDq pin and the normal output mode for the TxDq pin by using port input mode register g (PIMg) and port output mode register g (POMg).

#### UART mode connection diagram (during communication at same potential)

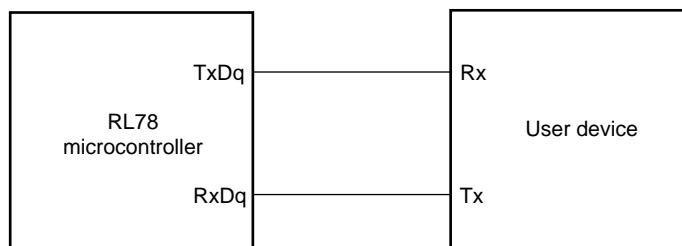

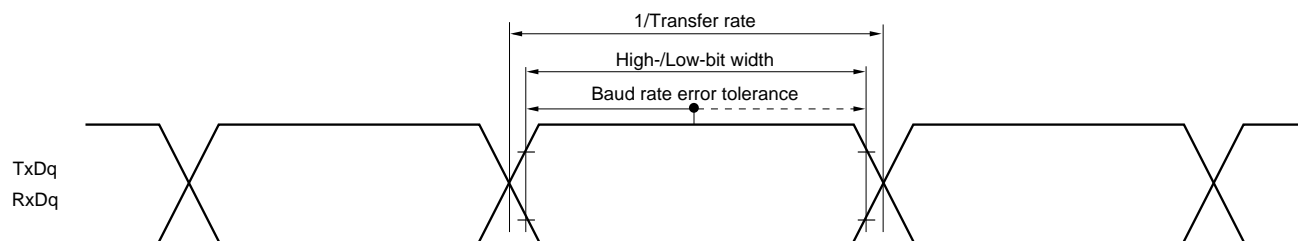
**UART mode bit width (during communication at same potential) (reference)**

- Remarks**
1. q: UART number (q = 0 to 3), g: PIM and POM number (g = 0, 1, 3)
  2.  $f_{\text{MCK}}$ : Serial array unit operation clock frequency  
(Operation clock to be set by the CKSmn bit of serial mode register mn (SMRmn). m: Unit number, n: Channel number (mn = 00 to 03, 10 to 13))

**(2) During communication at same potential (CSI mode) (master mode, SCKp... internal clock output)**(T<sub>A</sub> = -40 to +85°C, 1.6 V ≤ V<sub>DD</sub> ≤ 5.5 V, V<sub>SS</sub> = 0 V)

Parameter	Symbol	Conditions	HS (high-speed main) Mode		LS (low-speed main) Mode		LV (low-voltage main) Mode		Unit
			MIN.	MAX.	MIN.	MAX.	MIN.	MAX.	
SCKp cycle time	t <sub>KCY1</sub>	2.7 V ≤ V <sub>DD</sub> ≤ 5.5 V	167 <sup>Note 1</sup>		500 <sup>Note 1</sup>		1000 <sup>Note 1</sup>		ns
		2.4 V ≤ V <sub>DD</sub> ≤ 5.5 V	250 <sup>Note 1</sup>		500 <sup>Note 1</sup>		1000 <sup>Note 1</sup>		ns
		1.8 V ≤ V <sub>DD</sub> ≤ 5.5 V	–		500 <sup>Note 1</sup>		1000 <sup>Note 1</sup>		ns
		1.6 V ≤ V <sub>DD</sub> ≤ 5.5 V	–		–		1000 <sup>Note 1</sup>		ns
SCKp high-/low-level width	t <sub>KH1</sub> , t <sub>KL1</sub>	4.0 V ≤ V <sub>DD</sub> ≤ 5.5 V	t <sub>KCY1</sub> /2–12		t <sub>KCY1</sub> /2–50		t <sub>KCY1</sub> /2–50		ns
		2.7 V ≤ V <sub>DD</sub> ≤ 5.5 V	t <sub>KCY1</sub> /2–18		t <sub>KCY1</sub> /2–50		t <sub>KCY1</sub> /2–50		ns
		2.4 V ≤ V <sub>DD</sub> ≤ 5.5 V	t <sub>KCY1</sub> /2–38		t <sub>KCY1</sub> /2–50		t <sub>KCY1</sub> /2–50		ns
		1.8 V ≤ V <sub>DD</sub> ≤ 5.5 V	–		t <sub>KCY1</sub> /2–50		t <sub>KCY1</sub> /2–50		ns
		1.6 V ≤ V <sub>DD</sub> ≤ 5.5 V	–		–		t <sub>KCY1</sub> /2–100		ns
Slp setup time (to SCKp↑) <sup>Note 2</sup>	t <sub>SIK1</sub>	2.7 V ≤ V <sub>DD</sub> ≤ 5.5 V	44		110		110		ns
		2.4 V ≤ V <sub>DD</sub> ≤ 5.5 V	75		110		110		ns
		1.8 V ≤ V <sub>DD</sub> ≤ 5.5 V	–		110		110		ns
		1.6 V ≤ V <sub>DD</sub> ≤ 5.5 V	–		–		220		ns
Slp hold time (from SCKp↑) <sup>Note 3</sup>	t <sub>KSI1</sub>	2.4 V ≤ V <sub>DD</sub> ≤ 5.5 V	19		19		19		ns
		1.8 V ≤ V <sub>DD</sub> ≤ 5.5 V	–		19		19		ns
		1.6 V ≤ V <sub>DD</sub> ≤ 5.5 V	–		–		19		ns
Delay time from SCKp↓ to SOp output <sup>Note 4</sup>	t <sub>KSO1</sub>	C = 30 pF <sup>Note 5</sup>	2.4 V ≤ V <sub>DD</sub> ≤ 5.5 V		25		25	25	ns
			1.8 V ≤ V <sub>DD</sub> ≤ 5.5 V		–		25	25	ns
			1.6 V ≤ V <sub>DD</sub> ≤ 5.5 V		–		–	25	ns

**Notes 1.** The value must also be equal to or more than 2/f<sub>CLK</sub> for CSI00 and equal to or more than 4/f<sub>CLK</sub> for CSI10.

2. When DAP<sub>mn</sub> = 0 and CKP<sub>mn</sub> = 0, or DAP<sub>mn</sub> = 1 and CKP<sub>mn</sub> = 1. The Slp setup time becomes “to SCKp↓” when DAP<sub>mn</sub> = 0 and CKP<sub>mn</sub> = 1, or DAP<sub>mn</sub> = 1 and CKP<sub>mn</sub> = 0.
3. When DAP<sub>mn</sub> = 0 and CKP<sub>mn</sub> = 0, or DAP<sub>mn</sub> = 1 and CKP<sub>mn</sub> = 1. The Slp hold time becomes “from SCKp↓” when DAP<sub>mn</sub> = 0 and CKP<sub>mn</sub> = 1, or DAP<sub>mn</sub> = 1 and CKP<sub>mn</sub> = 0.
4. When DAP<sub>mn</sub> = 0 and CKP<sub>mn</sub> = 0, or DAP<sub>mn</sub> = 1 and CKP<sub>mn</sub> = 1. The delay time to SOp output becomes “from SCKp↑” when DAP<sub>mn</sub> = 0 and CKP<sub>mn</sub> = 1, or DAP<sub>mn</sub> = 1 and CKP<sub>mn</sub> = 0.
5. C is the load capacitance of the SCKp and SOp output lines.

**Caution** Select the normal input buffer for the Slp pin and the normal output mode for the SOp pin and SCKp pin by using port input mode register g (PIMg) and port output mode register g (POMg).

**Remarks 1.** p: CSI number (p = 00, 10), m: Unit number (m = 0), n: Channel number (n = 0, 2),

g: PIM and POM numbers (g = 0, 1)

2. f<sub>MCK</sub>: Serial array unit operation clock frequency

(Operation clock to be set by the CKS<sub>mn</sub> bit of serial mode register mn (SMR<sub>mn</sub>). m: Unit number,

n: Channel number (mn = 00, 02))

**(3) During communication at same potential (CSI mode) (slave mode, SCKp... external clock input)**(T<sub>A</sub> = -40 to +85°C, 1.6 V ≤ V<sub>DD</sub> ≤ 5.5 V, V<sub>SS</sub> = 0 V)

Parameter	Symbol	Conditions		HS (high-speed main) Mode		LS (low-speed main) Mode		LV (low-voltage main) Mode		Unit
				MIN.	MAX.	MIN.	MAX.	MIN.	MAX.	
SCKp cycle time <sup>Note 5</sup>	t <sub>KCY2</sub>	4.0 V ≤ V <sub>DD</sub> ≤ 5.5 V	f <sub>MCK</sub> > 20 MHz	8/f <sub>MCK</sub>		–		–		ns
			f <sub>MCK</sub> ≤ 20 MHz	6/f <sub>MCK</sub>		6/f <sub>MCK</sub>		6/f <sub>MCK</sub>		ns
		2.7 V ≤ V <sub>DD</sub> ≤ 5.5 V	f <sub>MCK</sub> > 16 MHz	8/f <sub>MCK</sub>		–		–		ns
			f <sub>MCK</sub> ≤ 16 MHz	6/f <sub>MCK</sub>		6/f <sub>MCK</sub>		6/f <sub>MCK</sub>		ns
		2.4 V ≤ V <sub>DD</sub> ≤ 5.5 V		6/f <sub>MCK</sub> and 500		6/f <sub>MCK</sub>		6/f <sub>MCK</sub>		ns
		1.8 V ≤ V <sub>DD</sub> ≤ 5.5 V		–		6/f <sub>MCK</sub>		6/f <sub>MCK</sub>		ns
1.6 V ≤ V <sub>DD</sub> ≤ 5.5 V		–		–		6/f <sub>MCK</sub>		ns		
SCKp high-/low-level width	t <sub>KH2</sub> , t <sub>KL2</sub>	4.0 V ≤ V <sub>DD</sub> ≤ 5.5 V		t <sub>KCY2</sub> /2–7		t <sub>KCY2</sub> /2–7		t <sub>KCY2</sub> /2–7		ns
		2.7 V ≤ V <sub>DD</sub> ≤ 5.5 V		t <sub>KCY2</sub> /2–8		t <sub>KCY2</sub> /2–8		t <sub>KCY2</sub> /2–8		ns
		2.4 V ≤ V <sub>DD</sub> ≤ 5.5 V		t <sub>KCY2</sub> /2–18		t <sub>KCY2</sub> /2–18		t <sub>KCY2</sub> /2–18		ns
		1.8 V ≤ V <sub>DD</sub> ≤ 5.5 V		–		t <sub>KCY2</sub> /2–18		t <sub>KCY2</sub> /2–18		ns
		1.6 V ≤ V <sub>DD</sub> ≤ 5.5 V		–		–		t <sub>KCY2</sub> /2–66		ns
Slp setup time (to SCKp↑) <sup>Note 1</sup>	t <sub>SIK2</sub>	2.7 V ≤ V <sub>DD</sub> ≤ 5.5 V		1/f <sub>MCK</sub> +20		1/f <sub>MCK</sub> +30		1/f <sub>MCK</sub> +30		ns
		2.4 V ≤ V <sub>DD</sub> ≤ 5.5 V		1/f <sub>MCK</sub> +30		1/f <sub>MCK</sub> +30		1/f <sub>MCK</sub> +30		ns
		1.8 V ≤ V <sub>DD</sub> ≤ 5.5 V		–		1/f <sub>MCK</sub> +30		1/f <sub>MCK</sub> +30		ns
		1.6 V ≤ V <sub>DD</sub> ≤ 5.5 V		–		–		1/f <sub>MCK</sub> +40		ns
Slp hold time (from SCKp↑) <sup>Note 2</sup>	t <sub>SI2</sub>	2.4 V ≤ V <sub>DD</sub> ≤ 5.5 V		1/f <sub>MCK</sub> +31		1/f <sub>MCK</sub> +31		1/f <sub>MCK</sub> +31		ns
		1.8 V ≤ V <sub>DD</sub> ≤ 5.5 V		–		1/f <sub>MCK</sub> +31		1/f <sub>MCK</sub> +31		ns
		1.6 V ≤ V <sub>DD</sub> ≤ 5.5 V		–		–		1/f <sub>MCK</sub> +250		ns
Delay time from SCKp↓ to SOP output <sup>Note 3</sup>	t <sub>KSO2</sub>	C = 30 pF <sup>Note 4</sup>	2.7 V ≤ V <sub>DD</sub> ≤ 5.5 V		2/f <sub>MCK</sub> +44		2/f <sub>MCK</sub> +110		2/f <sub>MCK</sub> +110	ns
			2.4 V ≤ V <sub>DD</sub> ≤ 5.5 V		2/f <sub>MCK</sub> +75		2/f <sub>MCK</sub> +110		2/f <sub>MCK</sub> +110	ns
			1.8 V ≤ V <sub>DD</sub> ≤ 5.5 V		–		2/f <sub>MCK</sub> +110		2/f <sub>MCK</sub> +110	ns
			1.6 V ≤ V <sub>DD</sub> ≤ 5.5 V		–		–		2/f <sub>MCK</sub> +220	ns

- Notes**
1. When DAP<sub>mn</sub> = 0 and CKP<sub>mn</sub> = 0, or DAP<sub>mn</sub> = 1 and CKP<sub>mn</sub> = 1. The Slp setup time becomes “to SCKp↓” when DAP<sub>mn</sub> = 0 and CKP<sub>mn</sub> = 1, or DAP<sub>mn</sub> = 1 and CKP<sub>mn</sub> = 0.
  2. When DAP<sub>mn</sub> = 0 and CKP<sub>mn</sub> = 0, or DAP<sub>mn</sub> = 1 and CKP<sub>mn</sub> = 1. The Slp hold time becomes “from SCKp↓” when DAP<sub>mn</sub> = 0 and CKP<sub>mn</sub> = 1, or DAP<sub>mn</sub> = 1 and CKP<sub>mn</sub> = 0.
  3. When DAP<sub>mn</sub> = 0 and CKP<sub>mn</sub> = 0, or DAP<sub>mn</sub> = 1 and CKP<sub>mn</sub> = 1. The delay time to SOP output becomes “from SCKp↑” when DAP<sub>mn</sub> = 0 and CKP<sub>mn</sub> = 1, or DAP<sub>mn</sub> = 1 and CKP<sub>mn</sub> = 0.
  4. C is the load capacitance of the SOP output lines.
  5. Transfer rate in SNOOZE mode: MAX. 1 Mbps

**Caution** Select the normal input buffer for the Slp pin and SCKp pin and the normal output mode for the SOP pin by using port input mode register g (PIMg) and port output mode register g (POMg).

- Remarks**
1. p: CSI number (p = 00, 10), m: Unit number (m = 0), n: Channel number (n = 0, 2), g: PIM number (g = 0, 1)
  2. f<sub>MCK</sub>: Serial array unit operation clock frequency (Operation clock to be set by the CKS<sub>mn</sub> bit of serial mode register mn (SMR<sub>mn</sub>). m: Unit number, n: Channel number (mn = 00, 02))

**CSI mode connection diagram (during communication at same potential)**

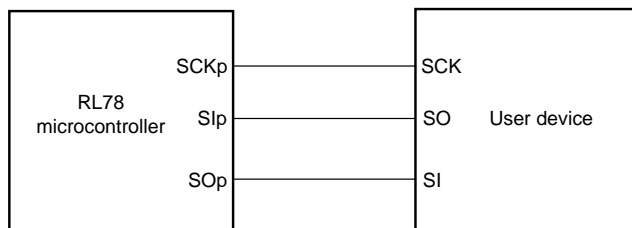

**CSI mode serial transfer timing (during communication at same potential)  
(When DAPmn = 0 and CKPmn = 0, or DAPmn = 1 and CKPmn = 1.)**

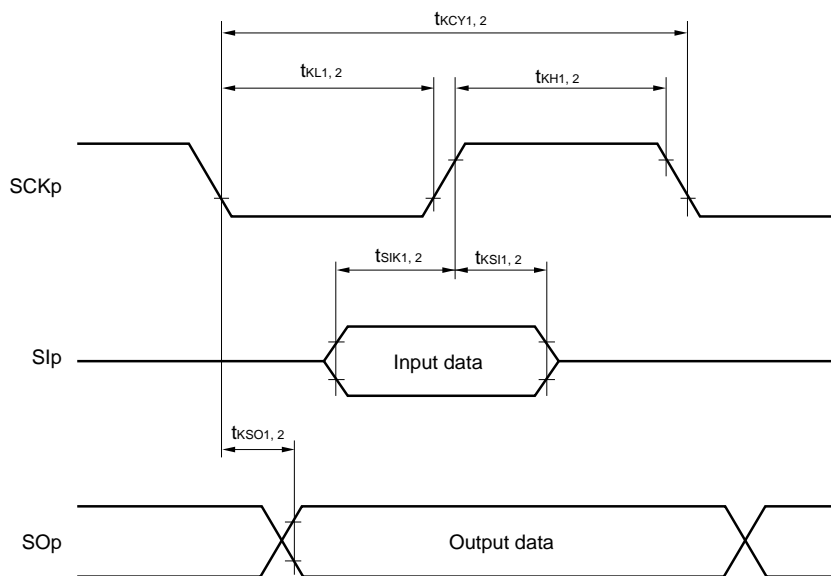

**CSI mode serial transfer timing (during communication at same potential)  
(When DAPmn = 0 and CKPmn = 1, or DAPmn = 1 and CKPmn = 0.)**

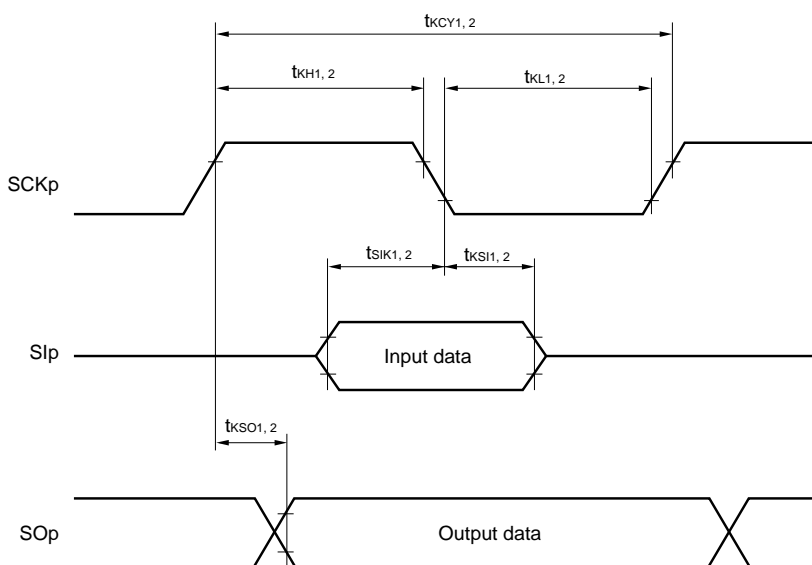

- Remarks 1. p: CSI number (p = 00, 10)
- 2. m: Unit number, n: Channel number (mn = 00, 02)

(4) During communication at same potential (simplified I<sup>2</sup>C mode)(T<sub>A</sub> = -40 to +85°C, 1.6 V ≤ V<sub>DD</sub> ≤ 5.5 V, V<sub>SS</sub> = 0 V)

Parameter	Symbol	Conditions	HS (high-speed main) Mode		LS (low-speed main) Mode		LV (low-voltage main) Mode		Unit
			MIN.	MAX.	MIN.	MAX.	MIN.	MAX.	
SCLr clock frequency	f <sub>SCL</sub>	2.7 V ≤ V <sub>DD</sub> ≤ 5.5 V, C <sub>b</sub> = 50 pF, R <sub>b</sub> = 2.7 kΩ		1000 <sup>Note 1</sup>		400 <sup>Note 1</sup>		400 <sup>Note 1</sup>	kHz
		1.8 V (2.4 V <sup>Note 3</sup> ) ≤ V <sub>DD</sub> ≤ 5.5 V, C <sub>b</sub> = 100 pF, R <sub>b</sub> = 3 kΩ		400 <sup>Note 1</sup>		400 <sup>Note 1</sup>		400 <sup>Note 1</sup>	kHz
		1.8 V (2.4 V <sup>Note 3</sup> ) ≤ V <sub>DD</sub> < 2.7 V, C <sub>b</sub> = 100 pF, R <sub>b</sub> = 5 kΩ		300 <sup>Note 1</sup>		300 <sup>Note 1</sup>		300 <sup>Note 1</sup>	kHz
		1.6 V ≤ V <sub>DD</sub> < 1.8 V, C <sub>b</sub> = 100 pF, R <sub>b</sub> = 5 kΩ		–		–		250 <sup>Note 1</sup>	kHz
Hold time when SCLr = "L"	t <sub>LOW</sub>	2.7 V ≤ V <sub>DD</sub> ≤ 5.5 V, C <sub>b</sub> = 50 pF, R <sub>b</sub> = 2.7 kΩ	475		1150		1150		ns
		1.8 V (2.4 V <sup>Note 3</sup> ) ≤ V <sub>DD</sub> ≤ 5.5 V, C <sub>b</sub> = 100 pF, R <sub>b</sub> = 3 kΩ	1150		1150		1150		ns
		1.8 V (2.4 V <sup>Note 3</sup> ) ≤ V <sub>DD</sub> < 2.7 V, C <sub>b</sub> = 100 pF, R <sub>b</sub> = 5 kΩ	1550		1550		1550		ns
		1.6 V ≤ V <sub>DD</sub> < 1.8 V, C <sub>b</sub> = 100 pF, R <sub>b</sub> = 5 kΩ	–		–		1850		ns
Hold time when SCLr = "H"	t <sub>HIGH</sub>	2.7 V ≤ V <sub>DD</sub> ≤ 5.5 V, C <sub>b</sub> = 50 pF, R <sub>b</sub> = 2.7 kΩ	475		1150		1150		ns
		1.8 V (2.4 V <sup>Note 3</sup> ) ≤ V <sub>DD</sub> ≤ 5.5 V, C <sub>b</sub> = 100 pF, R <sub>b</sub> = 3 kΩ	1150		1150		1150		ns
		1.8 V (2.4 V <sup>Note 3</sup> ) ≤ V <sub>DD</sub> < 2.7 V, C <sub>b</sub> = 100 pF, R <sub>b</sub> = 5 kΩ	1550		1550		1550		ns
		1.6 V ≤ V <sub>DD</sub> < 1.8 V, C <sub>b</sub> = 100 pF, R <sub>b</sub> = 5 kΩ	–		–		1850		ns
Data setup time (reception)	t <sub>SU:DAT</sub>	2.7 V ≤ V <sub>DD</sub> ≤ 5.5 V, C <sub>b</sub> = 50 pF, R <sub>b</sub> = 2.7 kΩ	1/f <sub>MCK</sub> + 85 <sup>Note 2</sup>		1/f <sub>MCK</sub> + 145 <sup>Note 2</sup>		1/f <sub>MCK</sub> + 145 <sup>Note 2</sup>		ns
		1.8 V (2.4 V <sup>Note 3</sup> ) ≤ V <sub>DD</sub> ≤ 5.5 V, C <sub>b</sub> = 100 pF, R <sub>b</sub> = 3 kΩ	1/f <sub>MCK</sub> + 145 <sup>Note 2</sup>		1/f <sub>MCK</sub> + 145 <sup>Note 2</sup>		1/f <sub>MCK</sub> + 145 <sup>Note 2</sup>		ns
		1.8 V (2.4 V <sup>Note 3</sup> ) ≤ V <sub>DD</sub> < 2.7 V, C <sub>b</sub> = 100 pF, R <sub>b</sub> = 5 kΩ	1/f <sub>MCK</sub> + 230 <sup>Note 2</sup>		1/f <sub>MCK</sub> + 230 <sup>Note 2</sup>		1/f <sub>MCK</sub> + 230 <sup>Note 2</sup>		ns
		1.6 V ≤ V <sub>DD</sub> < 1.8 V, C <sub>b</sub> = 100 pF, R <sub>b</sub> = 5 kΩ	–		–		1/f <sub>MCK</sub> + 290 <sup>Note 2</sup>		ns
Data hold time (transmission)	t <sub>HD:DAT</sub>	2.7 V ≤ V <sub>DD</sub> ≤ 5.5 V, C <sub>b</sub> = 50 pF, R <sub>b</sub> = 2.7 kΩ	0	305	0	305	0	305	ns
		1.8 V (2.4 V <sup>Note 3</sup> ) ≤ V <sub>DD</sub> ≤ 5.5 V, C <sub>b</sub> = 100 pF, R <sub>b</sub> = 3 kΩ	0	355	0	355	0	355	ns
		1.8 V (2.4 V <sup>Note 3</sup> ) ≤ V <sub>DD</sub> < 2.7 V, C <sub>b</sub> = 100 pF, R <sub>b</sub> = 5 kΩ	0	405	0	405	0	405	ns
		1.6 V ≤ V <sub>DD</sub> < 1.8 V, C <sub>b</sub> = 100 pF, R <sub>b</sub> = 5 kΩ	–	–	–	–	0	405	ns

(Notes, Caution, and Remarks are listed on the next page.)

- Notes**
1. The value must also be equal to or less than  $f_{MCK}/4$ .
  2. Set the  $f_{MCK}$  value to keep the hold time of SCLr = "L" and SCLr = "H".
  3. Condition in the HS (high-speed main) mode

**Caution** Select the normal input buffer and the N-ch open drain output (V<sub>DD</sub> tolerance) mode for the SDAr pin and the normal output mode for the SCLr pin by using port input mode register g (PIMg) and port output mode register g (POMg).

**Simplified I<sup>2</sup>C mode connection diagram (during communication at same potential)**

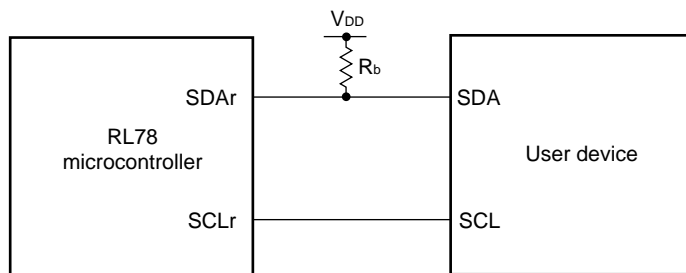

**Simplified I<sup>2</sup>C mode serial transfer timing (during communication at same potential)**

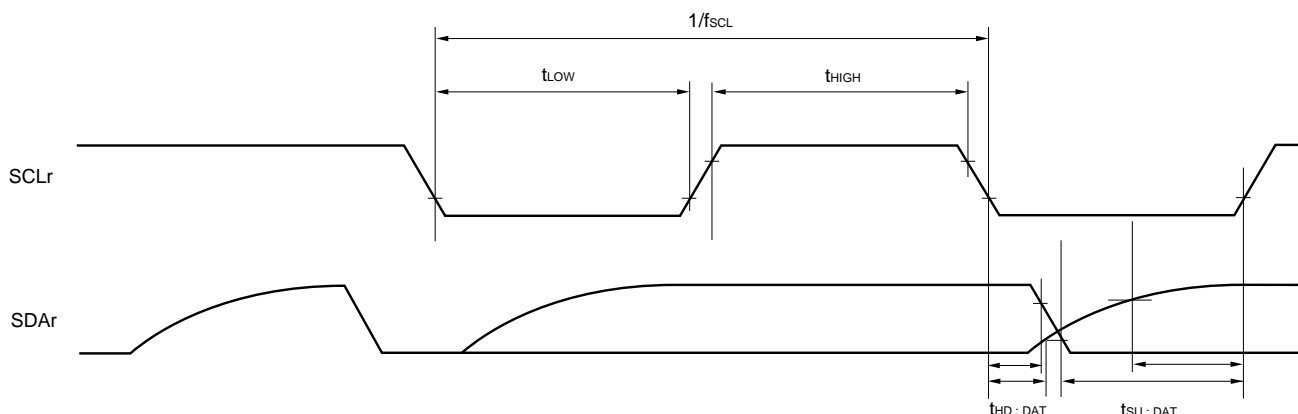

- Remarks**
1. R<sub>b</sub>[Ω]: Communication line (SDAr) pull-up resistance, C<sub>b</sub>[F]: Communication line (SDAr, SCLr) load capacitance
  2. r: IIC number (r = 00, 10), g: PIM and POM number (g = 0, 1)
  3. f<sub>MCK</sub>: Serial array unit operation clock frequency  
(Operation clock to be set by the CKSmn bit of serial mode register mn (SMRmn). m: Unit number (m = 0), n: Channel number (n = 0-3), mn = 00-03, 10-13)

<R>

**(5) Communication at different potential (1.8 V, 2.5 V, 3 V) (UART mode) (1/2)**(T<sub>A</sub> = -40 to +85°C, 1.8 V ≤ V<sub>DD</sub> ≤ 5.5 V, V<sub>SS</sub> = 0 V)

Parameter	Symbol	Conditions	HS (high-speed main) Mode		LS (low-speed main) Mode		LV (low-voltage main) Mode		Unit	
			MIN.	MAX.	MIN.	MAX.	MIN.	MAX.		
Transfer rate		Reception	4.0 V ≤ V <sub>DD</sub> ≤ 5.5 V, 2.7 V ≤ V <sub>b</sub> ≤ 4.0 V		f <sub>MCK</sub> /6 <sup>Note 1</sup>		f <sub>MCK</sub> /6 <sup>Note 1</sup>		f <sub>MCK</sub> /6 <sup>Note 1</sup>	bps
			Theoretical value of the maximum transfer rate f <sub>MCK</sub> = f <sub>CLK</sub> <sup>Note 3</sup>		4.0		1.3		0.6	Mbps
		2.7 V ≤ V <sub>DD</sub> < 4.0 V, 2.3 V ≤ V <sub>b</sub> ≤ 2.7 V		f <sub>MCK</sub> /6 <sup>Note 1</sup>		f <sub>MCK</sub> /6 <sup>Note 1</sup>		f <sub>MCK</sub> /6 <sup>Note 1</sup>	bps	
		Theoretical value of the maximum transfer rate f <sub>MCK</sub> = f <sub>CLK</sub> <sup>Note 3</sup>		4.0		1.3		0.6	Mbps	
		1.8 V (2.4 V <sup>Note 4</sup> ) ≤ V <sub>DD</sub> < 3.3 V, 1.6 V ≤ V <sub>b</sub> ≤ 2.0 V		f <sub>MCK</sub> /6 <sup>Note s1, 2</sup>		f <sub>MCK</sub> /6 <sup>Notes 1, 2</sup>		f <sub>MCK</sub> /6 <sup>Notes 1, 2</sup>	bps	
		Theoretical value of the maximum transfer rate f <sub>MCK</sub> = f <sub>CLK</sub> <sup>Note 3</sup>		4.0		1.3		0.6	Mbps	

**Notes 1.** Transfer rate in SNOOZE mode is 4800 bps only.**2.** Use it with V<sub>DD</sub> ≥ V<sub>b</sub>.**3.** The maximum operating frequencies of the CPU/peripheral hardware clock (f<sub>CLK</sub>) are:HS (high-speed main) mode: 24 MHz (2.7 V ≤ V<sub>DD</sub> ≤ 5.5 V)16 MHz (2.4 V ≤ V<sub>DD</sub> ≤ 5.5 V)LS (low-speed main) mode: 8 MHz (1.8 V ≤ V<sub>DD</sub> ≤ 5.5 V)LV (low-voltage main) mode: 4 MHz (1.6 V ≤ V<sub>DD</sub> ≤ 5.5 V)**4.** Condition in the HS (high-speed main) mode

**Caution** Select the TTL input buffer for the Rx<sub>Dq</sub> pin and the N-ch open drain output (V<sub>DD</sub> tolerance) mode for the Tx<sub>Dq</sub> pin by using port input mode register g (PIMg) and port output mode register g (POMg). For V<sub>IH</sub> and V<sub>IL</sub>, see the DC characteristics with TTL input buffer selected.

**Remarks 1.** V<sub>b</sub>[V]: Communication line voltage**2.** q: UART number (q = 0 to 3), g: PIM and POM number (g = 0, 1, 3)**3.** f<sub>MCK</sub>: Serial array unit operation clock frequency

(Operation clock to be set by the CKSmn bit of serial mode register mn (SMRmn). m: Unit number,

n: Channel number (mn = 00 to 03, 10 to 13)



**(5) Communication at different potential (1.8 V, 2.5 V, 3 V) (UART mode) (2/2)**(T<sub>A</sub> = -40 to +85°C, 1.8 V ≤ V<sub>DD</sub> ≤ 5.5 V, V<sub>SS</sub> = 0 V)

Parameter	Symbol	Conditions	HS (high-speed main) Mode		LS (low-speed main) Mode		LV (low-voltage main) Mode		Unit
			MIN.	MAX.	MIN.	MAX.	MIN.	MAX.	
Transfer rate	Transmission	4.0 V ≤ V <sub>DD</sub> ≤ 5.5 V, 2.7 V ≤ V <sub>b</sub> ≤ 4.0 V		Note 1		Note 1		Note 1	bps
		Theoretical value of the maximum transfer rate (C <sub>b</sub> = 50 pF, R <sub>b</sub> = 1.4 kΩ, V <sub>b</sub> = 2.7 V)		2.8 <sup>Note 2</sup>		2.8 <sup>Note 2</sup>		2.8 <sup>Note 2</sup>	Mbps
		2.7 V ≤ V <sub>DD</sub> < 4.0 V, 2.3 V ≤ V <sub>b</sub> ≤ 2.7 V		Note 3		Note 3		Note 3	bps
		Theoretical value of the maximum transfer rate (C <sub>b</sub> = 50 pF, R <sub>b</sub> = 2.7 kΩ, V <sub>b</sub> = 2.3 V)		1.2 <sup>Note 4</sup>		1.2 <sup>Note 4</sup>		1.2 <sup>Note 4</sup>	Mbps
		1.8 V (2.4 V <sup>Note 8</sup> ) ≤ V <sub>DD</sub> < 3.3 V, 1.6 V ≤ V <sub>b</sub> ≤ 2.0 V		Notes 5, 6		Notes 5, 6		Notes 5, 6	bps
		Theoretical value of the maximum transfer rate (C <sub>b</sub> = 50 pF, R <sub>b</sub> = 5.5 kΩ, V <sub>b</sub> = 1.6 V)		0.43 <sup>Note 7</sup>		0.43 <sup>Note 7</sup>		0.43 <sup>Note 7</sup>	Mbps

**Notes 1.** The smaller maximum transfer rate derived by using f<sub>MCK</sub>/6 or the following expression is the valid maximum transfer rate.

Expression for calculating the transfer rate when 4.0 V ≤ V<sub>DD</sub> ≤ 5.5 V and 2.7 V ≤ V<sub>b</sub> ≤ 4.0 V

$$\text{Maximum transfer rate} = \frac{1}{\{-C_b \times R_b \times \ln(1 - \frac{2.2}{V_b})\} \times 3} \text{ [bps]}$$

$$\text{Baud rate error (theoretical value)} = \frac{\frac{1}{\text{Transfer rate} \times 2} - \{-C_b \times R_b \times \ln(1 - \frac{2.2}{V_b})\}}{\left(\frac{1}{\text{Transfer rate}}\right) \times \text{Number of transferred bits}} \times 100 \text{ [%]}$$

\* This value is the theoretical value of the relative difference between the transmission and reception sides.

- This value as an example is calculated when the conditions described in the "Conditions" column are met. Refer to **Note 1** above to calculate the maximum transfer rate under conditions of the customer.
- The smaller maximum transfer rate derived by using f<sub>MCK</sub>/6 or the following expression is the valid maximum transfer rate.

Expression for calculating the transfer rate when 2.7 V ≤ V<sub>DD</sub> < 4.0 V and 2.3 V ≤ V<sub>b</sub> ≤ 2.7 V

$$\text{Maximum transfer rate} = \frac{1}{\{-C_b \times R_b \times \ln(1 - \frac{2.0}{V_b})\} \times 3} \text{ [bps]}$$

$$\text{Baud rate error (theoretical value)} = \frac{\frac{1}{\text{Transfer rate} \times 2} - \{-C_b \times R_b \times \ln(1 - \frac{2.0}{V_b})\}}{\left(\frac{1}{\text{Transfer rate}}\right) \times \text{Number of transferred bits}} \times 100 \text{ [%]}$$

\* This value is the theoretical value of the relative difference between the transmission and reception sides.

- This value as an example is calculated when the conditions described in the "Conditions" column are met. Refer to **Note 3** above to calculate the maximum transfer rate under conditions of the customer.
- Use it with V<sub>DD</sub> ≥ V<sub>b</sub>.

**Notes 6.** The smaller maximum transfer rate derived by using  $f_{MCK}/6$  or the following expression is the valid maximum transfer rate.

Expression for calculating the transfer rate when  $1.8\text{ V} (2.4\text{ V}^{\text{Note 8}}) \leq V_{DD} < 3.3\text{ V}$  and  $1.6\text{ V} \leq V_b \leq 2.0\text{ V}$

$$\text{Maximum transfer rate} = \frac{1}{\{-C_b \times R_b \times \ln(1 - \frac{1.5}{V_b})\} \times 3} \text{ [bps]}$$

$$\text{Baud rate error (theoretical value)} = \frac{\frac{1}{\text{Transfer rate} \times 2} - \{-C_b \times R_b \times \ln(1 - \frac{1.5}{V_b})\}}{(\frac{1}{\text{Transfer rate}}) \times \text{Number of transferred bits}} \times 100 \text{ [%]}$$

\* This value is the theoretical value of the relative difference between the transmission and reception sides.

7. This value as an example is calculated when the conditions described in the "Conditions" column are met. Refer to **Note 6** above to calculate the maximum transfer rate under conditions of the customer.
8. Condition in the HS (high-speed main) mode

**Caution** Select the TTL input buffer for the RxDq pin and the N-ch open drain output (V<sub>DD</sub> tolerance) mode for the TxDq pin by using port input mode register g (PIMg) and port output mode register g (POMg). For V<sub>IH</sub> and V<sub>IL</sub>, see the DC characteristics with TTL input buffer selected.

**UART mode connection diagram (during communication at different potential)**

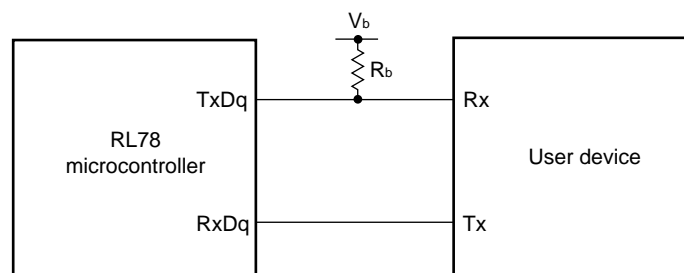

### UART mode bit width (during communication at different potential) (reference)



- Remarks 1.**  $R_b[\Omega]$ : Communication line (TxDq) pull-up resistance,  $C_b[F]$ : Communication line (TxDq) load capacitance,  $V_b[V]$ : Communication line voltage
- 2.**  $q$ : UART number ( $q = 0$  to  $3$ ),  $g$ : PIM and POM number ( $g = 0, 1, 3$ )
- 3.**  $f_{MCK}$ : Serial array unit operation clock frequency  
(Operation clock to be set by the CKSmn bit of serial mode register mn (SMRmn).  
 $m$ : Unit number,  $n$ : Channel number ( $mn = 00$  to  $03, 10$  to  $13$ ))

**(6) Communication at different potential (2.5 V, 3 V) (CSI mode) (master mode, SCKp... internal clock output, corresponding CSI00 only)****(T<sub>A</sub> = -40 to +85°C, 2.7 V ≤ V<sub>DD</sub> ≤ 5.5 V, V<sub>SS</sub> = 0 V)**

Parameter	Symbol	Conditions	HS (high-speed main) Mode		LS (low-speed main) Mode		LV (low-voltage main) Mode		Unit
			MIN.	MAX.	MIN.	MAX.	MIN.	MAX.	
SCKp cycle time	t <sub>KCY1</sub>	t <sub>KCY1</sub> ≥ 2/f <sub>CLK</sub> 4.0 V ≤ V <sub>DD</sub> ≤ 5.5 V, 2.7 V ≤ V <sub>b</sub> ≤ 4.0 V, C <sub>b</sub> = 20 pF, R <sub>b</sub> = 1.4 kΩ	200		1150		1150		ns
		2.7 V ≤ V <sub>DD</sub> < 4.0 V, 2.3 V ≤ V <sub>b</sub> ≤ 2.7 V, C <sub>b</sub> = 20 pF, R <sub>b</sub> = 2.7 kΩ	300		1150		1150		ns
SCKp high-level width	t <sub>KH1</sub>	4.0 V ≤ V <sub>DD</sub> ≤ 5.5 V, 2.7 V ≤ V <sub>b</sub> ≤ 4.0 V, C <sub>b</sub> = 20 pF, R <sub>b</sub> = 1.4 kΩ	t <sub>KCY1</sub> /2 – 50		t <sub>KCY1</sub> /2 – 50		t <sub>KCY1</sub> /2 – 50		ns
		2.7 V ≤ V <sub>DD</sub> < 4.0 V, 2.3 V ≤ V <sub>b</sub> ≤ 2.7 V, C <sub>b</sub> = 20 pF, R <sub>b</sub> = 2.7 kΩ	t <sub>KCY1</sub> /2 – 120		t <sub>KCY1</sub> /2 – 120		t <sub>KCY1</sub> /2 – 120		ns
SCKp low-level width	t <sub>KL1</sub>	4.0 V ≤ V <sub>DD</sub> ≤ 5.5 V, 2.7 V ≤ V <sub>b</sub> ≤ 4.0 V, C <sub>b</sub> = 20 pF, R <sub>b</sub> = 1.4 kΩ	t <sub>KCY1</sub> /2 – 7		t <sub>KCY1</sub> /2 – 50		t <sub>KCY1</sub> /2 – 50		ns
		2.7 V ≤ V <sub>DD</sub> < 4.0 V, 2.3 V ≤ V <sub>b</sub> ≤ 2.7 V, C <sub>b</sub> = 20 pF, R <sub>b</sub> = 2.7 kΩ	t <sub>KCY1</sub> /2 – 10		t <sub>KCY1</sub> /2 – 50		t <sub>KCY1</sub> /2 – 50		ns
Slp setup time (to SCKp↑) <sup>Note 1</sup>	t <sub>SIK1</sub>	4.0 V ≤ V <sub>DD</sub> ≤ 5.5 V, 2.7 V ≤ V <sub>b</sub> ≤ 4.0 V, C <sub>b</sub> = 20 pF, R <sub>b</sub> = 1.4 kΩ	58		479		479		ns
		2.7 V ≤ V <sub>DD</sub> < 4.0 V, 2.3 V ≤ V <sub>b</sub> ≤ 2.7 V, C <sub>b</sub> = 20 pF, R <sub>b</sub> = 2.7 kΩ	121		479		479		ns
Slp hold time (from SCKp↑) <sup>Note 1</sup>	t <sub>KSI1</sub>	4.0 V ≤ V <sub>DD</sub> ≤ 5.5 V, 2.7 V ≤ V <sub>b</sub> ≤ 4.0 V, C <sub>b</sub> = 20 pF, R <sub>b</sub> = 1.4 kΩ	10		10		10		ns
		2.7 V ≤ V <sub>DD</sub> < 4.0 V, 2.3 V ≤ V <sub>b</sub> ≤ 2.7 V, C <sub>b</sub> = 20 pF, R <sub>b</sub> = 2.7 kΩ	10		10		10		ns
Delay time from SCKp↓ to SOP output <sup>Note 1</sup>	t <sub>KSO1</sub>	4.0 V ≤ V <sub>DD</sub> ≤ 5.5 V, 2.7 V ≤ V <sub>b</sub> ≤ 4.0 V, C <sub>b</sub> = 20 pF, R <sub>b</sub> = 1.4 kΩ		60	60		60		ns
		2.7 V ≤ V <sub>DD</sub> < 4.0 V, 2.3 V ≤ V <sub>b</sub> ≤ 2.7 V, C <sub>b</sub> = 20 pF, R <sub>b</sub> = 2.7 kΩ		130	130		130		ns
Slp setup time (to SCKp↓) <sup>Note 2</sup>	t <sub>SIK1</sub>	4.0 V ≤ V <sub>DD</sub> ≤ 5.5 V, 2.7 V ≤ V <sub>b</sub> ≤ 4.0 V, C <sub>b</sub> = 20 pF, R <sub>b</sub> = 1.4 kΩ	23		110		110		ns
		2.7 V ≤ V <sub>DD</sub> < 4.0 V, 2.3 V ≤ V <sub>b</sub> ≤ 2.7 V, C <sub>b</sub> = 20 pF, R <sub>b</sub> = 2.7 kΩ	33		110		110		ns
Slp hold time (from SCKp↓) <sup>Note 2</sup>	t <sub>KSI1</sub>	4.0 V ≤ V <sub>DD</sub> ≤ 5.5 V, 2.7 V ≤ V <sub>b</sub> ≤ 4.0 V, C <sub>b</sub> = 20 pF, R <sub>b</sub> = 1.4 kΩ	10		10		10		ns
		2.7 V ≤ V <sub>DD</sub> < 4.0 V, 2.3 V ≤ V <sub>b</sub> ≤ 2.7 V, C <sub>b</sub> = 20 pF, R <sub>b</sub> = 2.7 kΩ	10		10		10		ns
Delay time from SCKp↑ to SOP output <sup>Note 2</sup>	t <sub>KSO1</sub>	4.0 V ≤ V <sub>DD</sub> ≤ 5.5 V, 2.7 V ≤ V <sub>b</sub> ≤ 4.0 V, C <sub>b</sub> = 20 pF, R <sub>b</sub> = 1.4 kΩ		10	10		10		ns
		2.7 V ≤ V <sub>DD</sub> < 4.0 V, 2.3 V ≤ V <sub>b</sub> ≤ 2.7 V, C <sub>b</sub> = 20 pF, R <sub>b</sub> = 2.7 kΩ		10	10		10		ns

**(Notes, Caution and Remarks are listed on the next page.)**

- Notes**
1. When  $DAP_{mn} = 0$  and  $CKP_{mn} = 0$ , or  $DAP_{mn} = 1$  and  $CKP_{mn} = 1$ .
  2. When  $DAP_{mn} = 0$  and  $CKP_{mn} = 1$ , or  $DAP_{mn} = 1$  and  $CKP_{mn} = 0$ .

**Caution** Select the TTL input buffer for the SIp pin and the N-ch open drain output ( $V_{DD}$  tolerance) mode for the SOp pin and SCKp pin by using port input mode register g (PIMg) and port output mode register g (POMg). For  $V_{IH}$  and  $V_{IL}$ , see the DC characteristics with TTL input buffer selected.

- Remarks**
1.  $R_b[\Omega]$ : Communication line (SCKp, SOp) pull-up resistance,  $C_b[\text{F}]$ : Communication line (SCKp, SOp) load capacitance,  $V_b[\text{V}]$ : Communication line voltage
  2. p: CSI number (p = 00), m: Unit number (m = 0), n: Channel number (n = 0),  
g: PIM and POM number (g = 1)
  3.  $f_{\text{MCK}}$ : Serial array unit operation clock frequency  
(Operation clock to be set by the CKSmn bit of serial mode register mn (SMRmn). m: Unit number,  
n: Channel number (mn = 00))
  4. This specification is valid only when CSI00's peripheral I/O redirect function is not used.

**(7) Communication at different potential (1.8 V, 2.5 V, 3 V) (CSI mode) (master mode, SCKp... internal clock output) (1/2)**  
**(T<sub>A</sub> = -40 to +85°C, 1.8 V ≤ V<sub>DD</sub> ≤ 5.5 V, V<sub>SS</sub> = 0 V)**

Parameter	Symbol	Conditions	HS (high-speed main) Mode		LS (low-speed main) Mode		LV (low-voltage main) Mode		Unit
			MIN.	MAX.	MIN.	MAX.	MIN.	MAX.	
SCKp cycle time	t <sub>KCY1</sub>	t <sub>KCY1</sub> ≥ 4/f <sub>CLK</sub> 4.0 V ≤ V <sub>DD</sub> ≤ 5.5 V, 2.7 V ≤ V <sub>b</sub> ≤ 4.0 V, C <sub>b</sub> = 30 pF, R <sub>b</sub> = 1.4 kΩ	300		1150		1150		ns
		2.7 V ≤ V <sub>DD</sub> < 4.0 V, 2.3 V ≤ V <sub>b</sub> ≤ 2.7 V, C <sub>b</sub> = 30 pF, R <sub>b</sub> = 2.7 kΩ	500		1150		1150		ns
		1.8 V (2.4 V <sup>Note 1</sup> ) ≤ V <sub>DD</sub> < 3.3 V, 1.6 V ≤ V <sub>b</sub> ≤ 1.8 V <sup>Note 2</sup> , C <sub>b</sub> = 30 pF, R <sub>b</sub> = 5.5 kΩ	1150		1150		1150		ns
SCKp high-level width	t <sub>KH1</sub>	4.0 V ≤ V <sub>DD</sub> ≤ 5.5 V, 2.7 V ≤ V <sub>b</sub> ≤ 4.0 V, C <sub>b</sub> = 30 pF, R <sub>b</sub> = 1.4 kΩ	t <sub>KCY1</sub> /2 – 75		t <sub>KCY1</sub> /2 – 75		t <sub>KCY1</sub> /2 – 75		ns
		2.7 V ≤ V <sub>DD</sub> < 4.0 V, 2.3 V ≤ V <sub>b</sub> ≤ 2.7 V, C <sub>b</sub> = 30 pF, R <sub>b</sub> = 2.7 kΩ	t <sub>KCY1</sub> /2 – 170		t <sub>KCY1</sub> /2 – 170		t <sub>KCY1</sub> /2 – 170		ns
		1.8 V (2.4 V <sup>Note 1</sup> ) ≤ V <sub>DD</sub> < 3.3 V, 1.6 V ≤ V <sub>b</sub> ≤ 2.0 V <sup>Note 2</sup> , C <sub>b</sub> = 30 pF, R <sub>b</sub> = 5.5 kΩ	t <sub>KCY1</sub> /2 – 458		t <sub>KCY1</sub> /2 – 458		t <sub>KCY1</sub> /2 – 458		ns
SCKp low-level width	t <sub>KL1</sub>	4.0 V ≤ V <sub>DD</sub> ≤ 5.5 V, 2.7 V ≤ V <sub>b</sub> ≤ 4.0 V, C <sub>b</sub> = 30 pF, R <sub>b</sub> = 1.4 kΩ	t <sub>KCY1</sub> /2 – 12		t <sub>KCY1</sub> /2 – 50		t <sub>KCY1</sub> /2 – 50		ns
		2.7 V ≤ V <sub>DD</sub> < 4.0 V, 2.3 V ≤ V <sub>b</sub> ≤ 2.7 V, C <sub>b</sub> = 30 pF, R <sub>b</sub> = 2.7 kΩ	t <sub>KCY1</sub> /2 – 18		t <sub>KCY1</sub> /2 – 50		t <sub>KCY1</sub> /2 – 50		ns
		1.8 V (2.4 V <sup>Note 1</sup> ) ≤ V <sub>DD</sub> < 3.3 V, 1.6 V ≤ V <sub>b</sub> ≤ 2.0 V <sup>Note 2</sup> , C <sub>b</sub> = 30 pF, R <sub>b</sub> = 5.5 kΩ	t <sub>KCY1</sub> /2 – 50		t <sub>KCY1</sub> /2 – 50		t <sub>KCY1</sub> /2 – 50		ns
Slp setup time (to SCKp↑) <sup>Note 3</sup>	t <sub>SIK1</sub>	4.0 V ≤ V <sub>DD</sub> ≤ 5.5 V, 2.7 V ≤ V <sub>b</sub> ≤ 4.0 V, C <sub>b</sub> = 30 pF, R <sub>b</sub> = 1.4 kΩ	81		479		479		ns
		2.7 V ≤ V <sub>DD</sub> < 4.0 V, 2.3 V ≤ V <sub>b</sub> ≤ 2.7 V, C <sub>b</sub> = 30 pF, R <sub>b</sub> = 2.7 kΩ	177		479		479		ns
		1.8 V (2.4 V <sup>Note 1</sup> ) ≤ V <sub>DD</sub> < 3.3 V, 1.6 V ≤ V <sub>b</sub> ≤ 2.0 V <sup>Note 2</sup> , C <sub>b</sub> = 30 pF, R <sub>b</sub> = 5.5 kΩ	479		479		479		ns
Slp hold time (from SCKp↑) <sup>Note 3</sup>	t <sub>KSH1</sub>	4.0 V ≤ V <sub>DD</sub> ≤ 5.5 V, 2.7 V ≤ V <sub>b</sub> ≤ 4.0 V, C <sub>b</sub> = 30 pF, R <sub>b</sub> = 1.4 kΩ	19		19		19		ns
		2.7 V ≤ V <sub>DD</sub> < 4.0 V, 2.3 V ≤ V <sub>b</sub> ≤ 2.7 V, C <sub>b</sub> = 30 pF, R <sub>b</sub> = 2.7 kΩ	19		19		19		ns
		1.8 V (2.4 V <sup>Note 1</sup> ) ≤ V <sub>DD</sub> < 3.3 V, 1.6 V ≤ V <sub>b</sub> ≤ 2.0 V <sup>Note 2</sup> , C <sub>b</sub> = 30 pF, R <sub>b</sub> = 5.5 kΩ	19		19		19		ns
Delay time from SCKp↓ to SOP output <sup>Note 3</sup>	t <sub>KSO1</sub>	4.0 V ≤ V <sub>DD</sub> ≤ 5.5 V, 2.7 V ≤ V <sub>b</sub> ≤ 4.0 V, C <sub>b</sub> = 30 pF, R <sub>b</sub> = 1.4 kΩ		100		100		100	ns
		2.7 V ≤ V <sub>DD</sub> < 4.0 V, 2.3 V ≤ V <sub>b</sub> ≤ 2.7 V, C <sub>b</sub> = 30 pF, R <sub>b</sub> = 2.7 kΩ		195		195		195	ns
		1.8 V (2.4 V <sup>Note 1</sup> ) ≤ V <sub>DD</sub> < 3.3 V, 1.6 V ≤ V <sub>b</sub> ≤ 2.0 V <sup>Note 2</sup> , C <sub>b</sub> = 30 pF, R <sub>b</sub> = 5.5 kΩ		483		483		483	ns

(Notes and Caution are listed on the next page, and Remarks are listed on the page after the next page.)

**(7) Communication at different potential (1.8 V, 2.5 V, 3 V) (CSI mode) (master mode, SCKp... internal clock output) (2/2)**  
 (T<sub>A</sub> = -40 to +85°C, 1.8 V ≤ V<sub>DD</sub> ≤ 5.5 V, V<sub>SS</sub> = 0 V)

Parameter	Symbol	Conditions	HS (high-speed main) Mode		LS (low-speed main) Mode		LV (low-voltage main) Mode		Unit
			MIN.	MAX.	MIN.	MAX.	MIN.	MAX.	
Slp setup time (to SCKp↓) <sup>Note 4</sup>	t <sub>SIK1</sub>	4.0 V ≤ V <sub>DD</sub> ≤ 5.5 V, 2.7 V ≤ V <sub>b</sub> ≤ 4.0 V, C <sub>b</sub> = 30 pF, R <sub>b</sub> = 1.4 kΩ	44		110		110		ns
		2.7 V ≤ V <sub>DD</sub> < 4.0 V, 2.3 V ≤ V <sub>b</sub> ≤ 2.7 V, C <sub>b</sub> = 30 pF, R <sub>b</sub> = 2.7 kΩ	44		110		110		ns
		1.8 V (2.4 V <sup>Note 1</sup> ) ≤ V <sub>DD</sub> < 3.3 V, 1.6 V ≤ V <sub>b</sub> ≤ 2.0 V <sup>Note 2</sup> , C <sub>b</sub> = 30 pF, R <sub>b</sub> = 5.5 kΩ	110		110		110		ns
Slp hold time (from SCKp↓) <sup>Note 4</sup>	t <sub>KS11</sub>	4.0 V ≤ V <sub>DD</sub> ≤ 5.5 V, 2.7 V ≤ V <sub>b</sub> ≤ 4.0 V, C <sub>b</sub> = 30 pF, R <sub>b</sub> = 1.4 kΩ	19		19		19		ns
		2.7 V ≤ V <sub>DD</sub> < 4.0 V, 2.3 V ≤ V <sub>b</sub> ≤ 2.7 V, C <sub>b</sub> = 30 pF, R <sub>b</sub> = 2.7 kΩ	19		19		19		ns
		1.8 V (2.4 V <sup>Note 1</sup> ) ≤ V <sub>DD</sub> < 3.3 V, 1.6 V ≤ V <sub>b</sub> ≤ 2.0 V <sup>Note 2</sup> , C <sub>b</sub> = 30 pF, R <sub>b</sub> = 5.5 kΩ	19		19		19		ns
Delay time from SCKp↑ to SOp output <sup>Note 4</sup>	t <sub>KSO1</sub>	4.0 V ≤ V <sub>DD</sub> ≤ 5.5 V, 2.7 V ≤ V <sub>b</sub> ≤ 4.0 V, C <sub>b</sub> = 30 pF, R <sub>b</sub> = 1.4 kΩ		25		25		25	ns
		2.7 V ≤ V <sub>DD</sub> < 4.0 V, 2.3 V ≤ V <sub>b</sub> ≤ 2.7 V, C <sub>b</sub> = 30 pF, R <sub>b</sub> = 2.7 kΩ		25		25		25	ns
		1.8 V (2.4 V <sup>Note 1</sup> ) ≤ V <sub>DD</sub> < 3.3 V, 1.6 V ≤ V <sub>b</sub> ≤ 2.0 V <sup>Note 2</sup> , C <sub>b</sub> = 30 pF, R <sub>b</sub> = 5.5 kΩ		25		25		25	ns

- Notes**
1. Condition in HS (high-speed main) mode
  2. Use it with V<sub>DD</sub> ≥ V<sub>b</sub>.
  3. When DAPmn = 0 and CKPmn = 0, or DAPmn = 1 and CKPmn = 1.
  4. When DAPmn = 0 and CKPmn = 1, or DAPmn = 1 and CKPmn = 0.

**Caution** Select the TTL input buffer for the Slp pin and the N-ch open drain output (V<sub>DD</sub> tolerance) mode for the SOp pin and SCKp pin by using port input mode register g (PIMg) and port output mode register g (POMg). For V<sub>IH</sub> and V<sub>IL</sub>, see the DC characteristics with TTL input buffer selected.

**CSI mode connection diagram (during communication at different potential)**

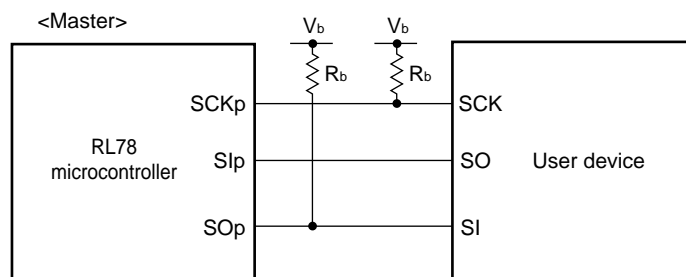

**CSI mode serial transfer timing (master mode) (during communication at different potential)  
(When DAPmn = 0 and CKPmn = 0, or DAPmn = 1 and CKPmn = 1.)**

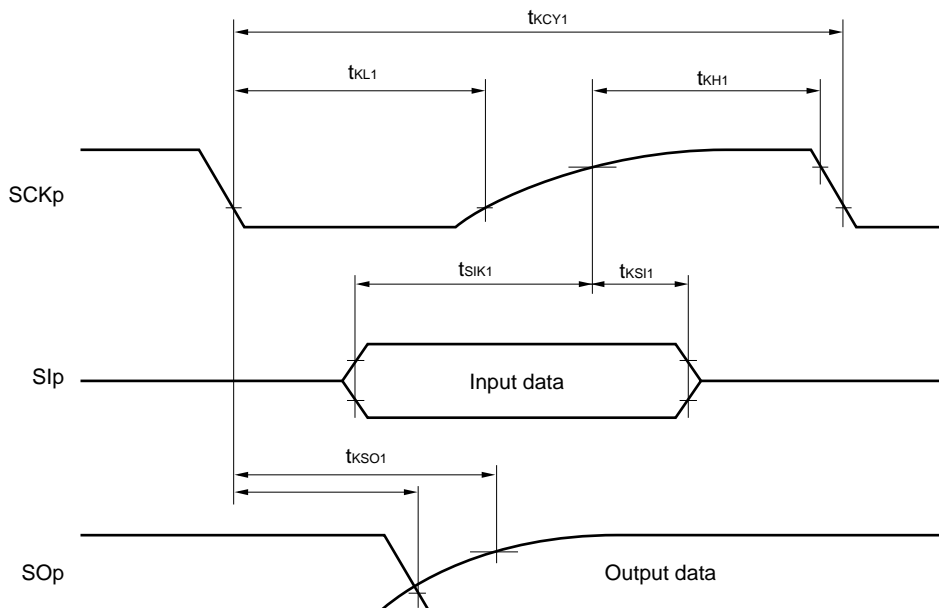

**CSI mode serial transfer timing (master mode) (during communication at different potential)  
(When DAPmn = 0 and CKPmn = 1, or DAPmn = 1 and CKPmn = 0.)**

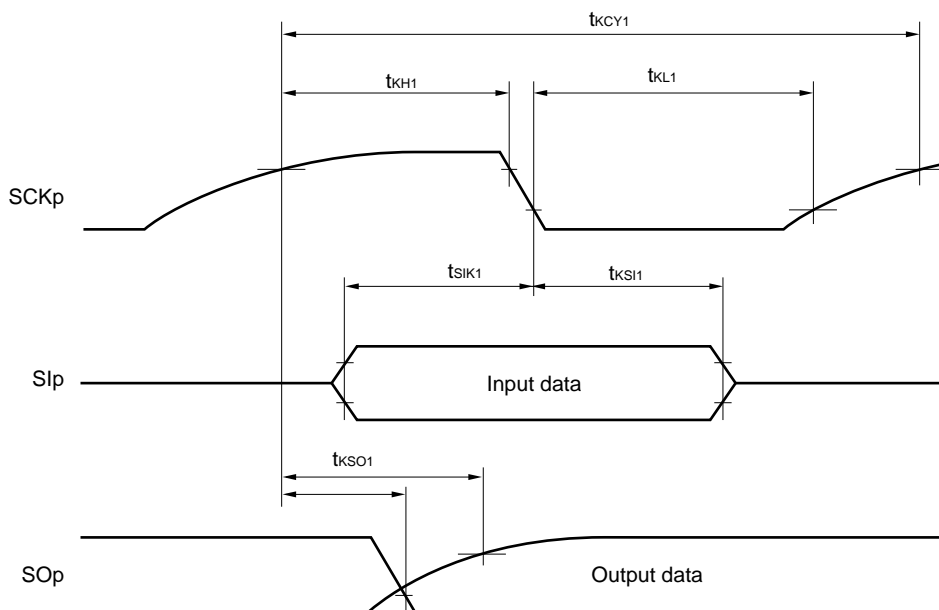

- Remarks 1.** R<sub>b</sub>[Ω]: Communication line (SCKp, SOp) pull-up resistance, C<sub>b</sub>[F]: Communication line (SCKp, SOp) load capacitance, V<sub>b</sub>[V]: Communication line voltage
- 2.** p: CSI number (p = 00, 10), m: Unit number, n: Channel number (mn = 00, 02), g: PIM and POM number (g = 0, 1)
- 3.** f<sub>MCK</sub>: Serial array unit operation clock frequency  
(Operation clock to be set by the CKS<sub>mn</sub> bit of serial mode register mn (SMR<sub>mn</sub>).  
m: Unit number, n: Channel number (mn = 00)



**(8) Communication at different potential (1.8 V, 2.5 V, 3 V) (CSI mode) (slave mode, SCKp... external clock input)**  
 (T<sub>A</sub> = -40 to +85°C, 1.8 V ≤ V<sub>DD</sub> ≤ 5.5 V, V<sub>SS</sub> = 0 V)

Parameter	Symbol	Conditions		HS (high-speed main) Mode		LS (low-speed main) Mode		LV (low-voltage main) Mode		Unit
				MIN.	MAX.	MIN.	MAX.	MIN.	MAX.	
SCKp cycle time <sup>Note 1</sup>	t <sub>KCY2</sub>	4.0 V ≤ V <sub>DD</sub> ≤ 5.5 V, 2.7 V ≤ V <sub>b</sub> ≤ 4.0 V	20 MHz < f <sub>MCK</sub>	12/f <sub>MCK</sub>		–		–		ns
			8 MHz < f <sub>MCK</sub> ≤ 20 MHz	10/f <sub>MCK</sub>		–		–		ns
			4 MHz < f <sub>MCK</sub> ≤ 8 MHz	8/f <sub>MCK</sub>		16/f <sub>MCK</sub>		–		ns
			f <sub>MCK</sub> ≤ 4 MHz	6/f <sub>MCK</sub>		10/f <sub>MCK</sub>		10/f <sub>MCK</sub>		ns
		2.7 V ≤ V <sub>DD</sub> < 4.0 V, 2.3 V ≤ V <sub>b</sub> ≤ 2.7 V	20 MHz < f <sub>MCK</sub>	16/f <sub>MCK</sub>		–		–		ns
			16 MHz < f <sub>MCK</sub> ≤ 20 MHz	14/f <sub>MCK</sub>		–		–		ns
			8 MHz < f <sub>MCK</sub> ≤ 16 MHz	12/f <sub>MCK</sub>		–		–		ns
			4 MHz < f <sub>MCK</sub> ≤ 8 MHz	8/f <sub>MCK</sub>		16/f <sub>MCK</sub>		–		ns
		1.8 V (2.4 V <sup>Note 2</sup> ) ≤ V <sub>DD</sub> < 3.3 V, 1.6 V ≤ V <sub>b</sub> ≤ 2.0 V <sup>Note 3</sup>	20 MHz < f <sub>MCK</sub>	36/f <sub>MCK</sub>		–		–		ns
			16 MHz < f <sub>MCK</sub> ≤ 20 MHz	32/f <sub>MCK</sub>		–		–		ns
			8 MHz < f <sub>MCK</sub> ≤ 16 MHz	26/f <sub>MCK</sub>		–		–		ns
			4 MHz < f <sub>MCK</sub> ≤ 8 MHz	16/f <sub>MCK</sub>		16/f <sub>MCK</sub>		–		ns
f <sub>MCK</sub> ≤ 4 MHz		10/f <sub>MCK</sub>		10/f <sub>MCK</sub>		10/f <sub>MCK</sub>		ns		
	SCKp high-/low-level width	t <sub>KH2</sub> , t <sub>KL2</sub>	4.0 V ≤ V <sub>DD</sub> ≤ 5.5 V, 2.7 V ≤ V <sub>b</sub> ≤ 4.0 V	t <sub>KCY2</sub> /2 – 12		t <sub>KCY2</sub> /2 – 50		t <sub>KCY2</sub> /2 – 50		ns
			2.7 V ≤ V <sub>DD</sub> < 4.0 V, 2.3 V ≤ V <sub>b</sub> ≤ 2.7 V	t <sub>KCY2</sub> /2 – 18		t <sub>KCY2</sub> /2 – 50		t <sub>KCY2</sub> /2 – 50		ns
			1.8 V (2.4 V <sup>Note 2</sup> ) ≤ V <sub>DD</sub> < 3.3 V, 1.6 V ≤ V <sub>b</sub> ≤ 2.0 V <sup>Note 3</sup>	t <sub>KCY2</sub> /2 – 50		t <sub>KCY2</sub> /2 – 50		t <sub>KCY2</sub> /2 – 50		ns
	Slp setup time (to SCKp↑) <sup>Note 4</sup>	t <sub>SIK2</sub>	4.0 V ≤ V <sub>DD</sub> ≤ 5.5 V, 2.7 V ≤ V <sub>b</sub> ≤ 4.0 V	1/f <sub>MCK</sub> + 20		1/f <sub>MCK</sub> + 30		1/f <sub>MCK</sub> + 30		ns
2.7 V ≤ V <sub>DD</sub> < 4.0 V, 2.3 V ≤ V <sub>b</sub> ≤ 2.7 V			1/f <sub>MCK</sub> + 20		1/f <sub>MCK</sub> + 30		1/f <sub>MCK</sub> + 30		ns	
1.8 V (2.4 V <sup>Note 2</sup> ) ≤ V <sub>DD</sub> < 3.3 V, 1.6 V ≤ V <sub>b</sub> ≤ 2.0 V <sup>Note 3</sup>			1/f <sub>MCK</sub> + 30		1/f <sub>MCK</sub> + 30		1/f <sub>MCK</sub> + 30		ns	
Slp hold time (from SCKp↑) <sup>Note 5</sup>	t <sub>SI2</sub>	4.0 V ≤ V <sub>DD</sub> ≤ 5.5 V, 2.7 V ≤ V <sub>b</sub> ≤ 4.0 V	1/f <sub>MCK</sub> + 31		1/f <sub>MCK</sub> + 31		1/f <sub>MCK</sub> + 31		ns	
		2.7 V ≤ V <sub>DD</sub> < 4.0 V, 2.3 V ≤ V <sub>b</sub> ≤ 2.7 V	1/f <sub>MCK</sub> + 31		1/f <sub>MCK</sub> + 31		1/f <sub>MCK</sub> + 31		ns	
		1.8 V (2.4 V <sup>Note 2</sup> ) ≤ V <sub>DD</sub> < 3.3 V, 1.6 V ≤ V <sub>b</sub> ≤ 2.0 V <sup>Note 3</sup>	1/f <sub>MCK</sub> + 31		1/f <sub>MCK</sub> + 31		1/f <sub>MCK</sub> + 31		ns	
Delay time from SCKp↓ to SOP output <sup>Note 6</sup>	t <sub>KSO2</sub>	4.0 V ≤ V <sub>DD</sub> ≤ 5.5 V, 2.7 V ≤ V <sub>b</sub> ≤ 4.0 V, C <sub>b</sub> = 30 pF, R <sub>b</sub> = 1.4 kΩ		2/f <sub>MCK</sub> + 120		2/f <sub>MCK</sub> + 573		2/f <sub>MCK</sub> + 573		ns
		2.7 V ≤ V <sub>DD</sub> < 4.0 V, 2.3 V ≤ V <sub>b</sub> ≤ 2.7 V, C <sub>b</sub> = 30 pF, R <sub>b</sub> = 2.7 kΩ		2/f <sub>MCK</sub> + 214		2/f <sub>MCK</sub> + 573		2/f <sub>MCK</sub> + 573		ns
		1.8 V (2.4 V <sup>Note 2</sup> ) ≤ V <sub>DD</sub> < 3.3 V, 1.6 V ≤ V <sub>b</sub> ≤ 2.0 V <sup>Note 3</sup> , C <sub>b</sub> = 30 pF, R <sub>b</sub> = 5.5 kΩ		2/f <sub>MCK</sub> + 573		2/f <sub>MCK</sub> + 573		2/f <sub>MCK</sub> + 573		ns

(Notes and Caution are listed on the next page, and Remarks are listed on the page after the next page.)

- Notes**
1. Transfer rate in SNOOZE mode: MAX. 1 Mbps
  2. Condition in HS (high-speed main) mode
  3. Use it with  $V_{DD} \geq V_b$ .
  4. When  $DAPmn = 0$  and  $CKPmn = 0$ , or  $DAPmn = 1$  and  $CKPmn = 1$ . The  $SIp$  setup time becomes “to  $SCKp\downarrow$ ” when  $DAPmn = 0$  and  $CKPmn = 1$ , or  $DAPmn = 1$  and  $CKPmn = 0$ .
  5. When  $DAPmn = 0$  and  $CKPmn = 0$ , or  $DAPmn = 1$  and  $CKPmn = 1$ . The  $SIp$  hold time becomes “from  $SCKp\downarrow$ ” when  $DAPmn = 0$  and  $CKPmn = 1$ , or  $DAPmn = 1$  and  $CKPmn = 0$ .
  6. When  $DAPmn = 0$  and  $CKPmn = 0$ , or  $DAPmn = 1$  and  $CKPmn = 1$ . The delay time to  $SOp$  output becomes “from  $SCKp\uparrow$ ” when  $DAPmn = 0$  and  $CKPmn = 1$ , or  $DAPmn = 1$  and  $CKPmn = 0$ .

**Caution** Select the TTL input buffer for the  $SIp$  pin and  $SCKp$  pin and the N-ch open drain output ( $V_{DD}$  tolerance) mode for the  $SOp$  pin by using port input mode register g (PIMg) and port output mode register g (POMg). For  $V_{IH}$  and  $V_{IL}$ , see the DC characteristics with TTL input buffer selected.

**CSI mode connection diagram (during communication at different potential)**

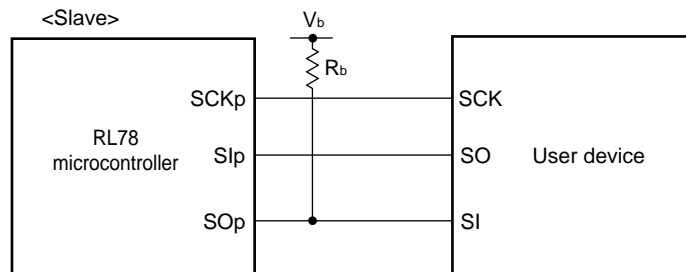

**CSI mode serial transfer timing (slave mode) (during communication at different potential)  
(When DAPmn = 0 and CKPmn = 0, or DAPmn = 1 and CKPmn = 1.)**

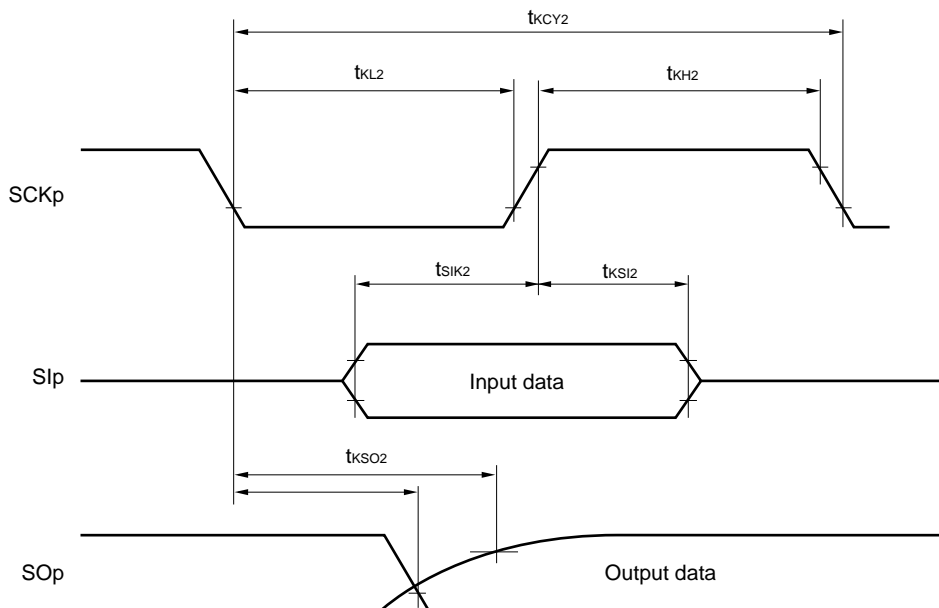

**CSI mode serial transfer timing (slave mode) (during communication at different potential)  
(When DAPmn = 0 and CKPmn = 1, or DAPmn = 1 and CKPmn = 0.)**

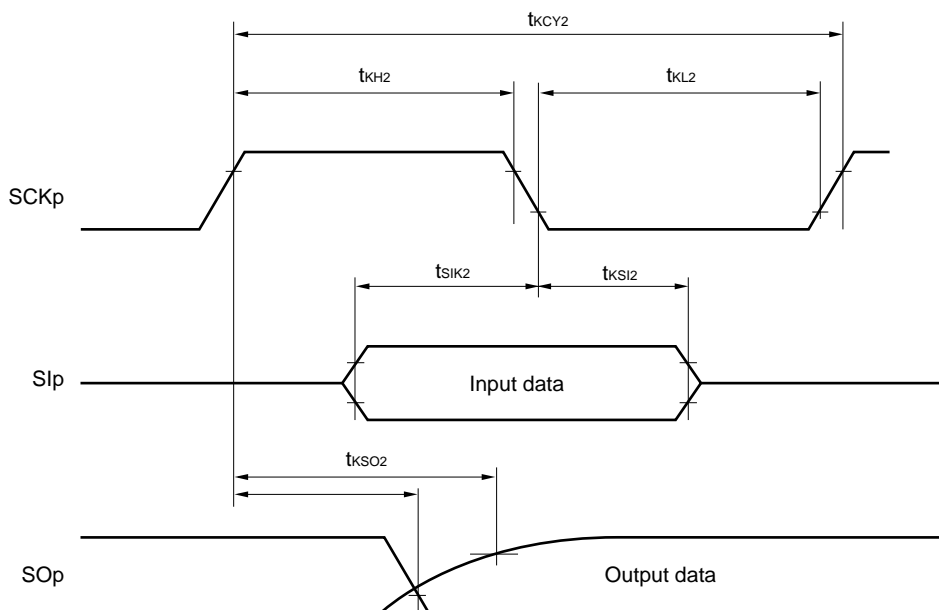

- Remarks 1.**  $R_b[\Omega]$ : Communication line (SO<sub>p</sub>) pull-up resistance,  $C_b[F]$ : Communication line (SO<sub>p</sub>) load capacitance,  $V_b[V]$ : Communication line voltage
- 2.** p: CSI number (p = 00, 10), m: Unit number, n: Channel number (mn = 00, 02), g: PIM and POM number (g = 0, 1)
- 3.**  $f_{MCK}$ : Serial array unit operation clock frequency  
(Operation clock to be set by the CKS<sub>mn</sub> bit of serial mode register mn (SMR<sub>mn</sub>))  
m: Unit number, n: Channel number (mn = 00, 02))

**(9) Communication at different potential (1.8 V, 2.5 V, 3 V) (simplified I<sup>2</sup>C mode) (1/2)****( $T_A = -40$  to  $+85^\circ\text{C}$ ,  $1.8\text{ V} \leq V_{DD} \leq 5.5\text{ V}$ ,  $V_{SS} = 0\text{ V}$ )**

Parameter	Symbol	Conditions	HS (high-speed main) Mode		LS (low-speed main) Mode		LV (low-voltage main) Mode		Unit
			MIN.	MAX.	MIN.	MAX.	MIN.	MAX.	
SCLr clock frequency	$f_{SCL}$	$4.0\text{ V} \leq V_{DD} \leq 5.5\text{ V}$ , $2.7\text{ V} \leq V_b \leq 4.0\text{ V}$ , $C_b = 50\text{ pF}$ , $R_b = 2.7\text{ k}\Omega$		1000 <sup>Note 1</sup>		300 <sup>Note 1</sup>		300 <sup>Note 1</sup>	kHz
		$2.7\text{ V} \leq V_{DD} < 4.0\text{ V}$ , $2.3\text{ V} \leq V_b \leq 2.7\text{ V}$ , $C_b = 50\text{ pF}$ , $R_b = 2.7\text{ k}\Omega$		1000 <sup>Note 1</sup>		300 <sup>Note 1</sup>		300 <sup>Note 1</sup>	kHz
		$4.0\text{ V} \leq V_{DD} \leq 5.5\text{ V}$ , $2.7\text{ V} \leq V_b \leq 4.0\text{ V}$ , $C_b = 100\text{ pF}$ , $R_b = 2.8\text{ k}\Omega$		400 <sup>Note 1</sup>		300 <sup>Note 1</sup>		300 <sup>Note 1</sup>	kHz
		$2.7\text{ V} \leq V_{DD} < 4.0\text{ V}$ , $2.3\text{ V} \leq V_b \leq 2.7\text{ V}$ , $C_b = 100\text{ pF}$ , $R_b = 2.7\text{ k}\Omega$		400 <sup>Note 1</sup>		300 <sup>Note 1</sup>		300 <sup>Note 1</sup>	kHz
		$1.8\text{ V} (2.4\text{ V}^{\text{Note 2}}) \leq V_{DD} < 3.3\text{ V}$ , $1.6\text{ V} \leq V_b \leq 2.0\text{ V}^{\text{Note 3}}$ , $C_b = 100\text{ pF}$ , $R_b = 5.5\text{ k}\Omega$		300 <sup>Note 1</sup>		300 <sup>Note 1</sup>		300 <sup>Note 1</sup>	kHz
Hold time when SCLr = "L"	$t_{LOW}$	$4.0\text{ V} \leq V_{DD} \leq 5.5\text{ V}$ , $2.7\text{ V} \leq V_b \leq 4.0\text{ V}$ , $C_b = 50\text{ pF}$ , $R_b = 2.7\text{ k}\Omega$	475		1550		1550		ns
		$2.7\text{ V} \leq V_{DD} < 4.0\text{ V}$ , $2.3\text{ V} \leq V_b \leq 2.7\text{ V}$ , $C_b = 50\text{ pF}$ , $R_b = 2.7\text{ k}\Omega$	475		1550		1550		ns
		$4.0\text{ V} \leq V_{DD} \leq 5.5\text{ V}$ , $2.7\text{ V} \leq V_b \leq 4.0\text{ V}$ , $C_b = 100\text{ pF}$ , $R_b = 2.8\text{ k}\Omega$	1150		1550		1550		ns
		$2.7\text{ V} \leq V_{DD} < 4.0\text{ V}$ , $2.3\text{ V} \leq V_b \leq 2.7\text{ V}$ , $C_b = 100\text{ pF}$ , $R_b = 2.7\text{ k}\Omega$	1150		1550		1550		ns
		$1.8\text{ V} (2.4\text{ V}^{\text{Note 2}}) \leq V_{DD} < 3.3\text{ V}$ , $1.6\text{ V} \leq V_b \leq 2.0\text{ V}^{\text{Note 3}}$ , $C_b = 100\text{ pF}$ , $R_b = 5.5\text{ k}\Omega$	1550		1550		1550		ns
Hold time when SCLr = "H"	$t_{HIGH}$	$4.0\text{ V} \leq V_{DD} \leq 5.5\text{ V}$ , $2.7\text{ V} \leq V_b \leq 4.0\text{ V}$ , $C_b = 50\text{ pF}$ , $R_b = 2.7\text{ k}\Omega$	245		610		610		ns
		$2.7\text{ V} \leq V_{DD} < 4.0\text{ V}$ , $2.3\text{ V} \leq V_b \leq 2.7\text{ V}$ , $C_b = 50\text{ pF}$ , $R_b = 2.7\text{ k}\Omega$	200		610		610		ns
		$4.0\text{ V} \leq V_{DD} \leq 5.5\text{ V}$ , $2.7\text{ V} \leq V_b \leq 4.0\text{ V}$ , $C_b = 100\text{ pF}$ , $R_b = 2.8\text{ k}\Omega$	675		610		610		ns
		$2.7\text{ V} \leq V_{DD} < 4.0\text{ V}$ , $2.3\text{ V} \leq V_b \leq 2.7\text{ V}$ , $C_b = 100\text{ pF}$ , $R_b = 2.7\text{ k}\Omega$	600		610		610		ns
		$1.8\text{ V} (2.4\text{ V}^{\text{Note 2}}) \leq V_{DD} < 3.3\text{ V}$ , $1.6\text{ V} \leq V_b \leq 2.0\text{ V}^{\text{Note 3}}$ , $C_b = 100\text{ pF}$ , $R_b = 5.5\text{ k}\Omega$	610		610		610		ns

**(Notes and Caution are listed on the next page, and Remarks are listed on the page after the next page.)**

**(9) Communication at different potential (1.8 V, 2.5 V, 3 V) (simplified I<sup>2</sup>C mode) (2/2)****(T<sub>A</sub> = -40 to +85°C, 1.8 V ≤ V<sub>DD</sub> ≤ 5.5 V, V<sub>SS</sub> = 0 V)**

Parameter	Symbol	Conditions	HS (high-speed main) Mode		LS (low-speed main) Mode		LV (low-voltage main) Mode		Unit
			MIN.	MAX.	MIN.	MAX.	MIN.	MAX.	
Data setup time (reception)	t <sub>SU:DAT</sub>	4.0 V ≤ V <sub>DD</sub> ≤ 5.5 V, 2.7 V ≤ V <sub>b</sub> ≤ 4.0 V, C <sub>b</sub> = 50 pF, R <sub>b</sub> = 2.7 kΩ	1/f <sub>MCK</sub> + 135 <sup>Note 4</sup>		1/f <sub>MCK</sub> + 190 <sup>Note 4</sup>		1/f <sub>MCK</sub> + 190 <sup>Note 4</sup>		ns
		2.7 V ≤ V <sub>DD</sub> < 4.0 V, 2.3 V ≤ V <sub>b</sub> ≤ 2.7 V, C <sub>b</sub> = 50 pF, R <sub>b</sub> = 2.7 kΩ	1/f <sub>MCK</sub> + 135 <sup>Note 4</sup>		1/f <sub>MCK</sub> + 190 <sup>Note 4</sup>		1/f <sub>MCK</sub> + 190 <sup>Note 4</sup>		ns
		4.0 V ≤ V <sub>DD</sub> ≤ 5.5 V, 2.7 V ≤ V <sub>b</sub> ≤ 4.0 V, C <sub>b</sub> = 100 pF, R <sub>b</sub> = 2.8 kΩ	1/f <sub>MCK</sub> + 190 <sup>Note 4</sup>		1/f <sub>MCK</sub> + 190 <sup>Note 4</sup>		1/f <sub>MCK</sub> + 190 <sup>Note 4</sup>		ns
		2.7 V ≤ V <sub>DD</sub> < 4.0 V, 2.3 V ≤ V <sub>b</sub> ≤ 2.7 V, C <sub>b</sub> = 100 pF, R <sub>b</sub> = 2.7 kΩ	1/f <sub>MCK</sub> + 190 <sup>Note 4</sup>		1/f <sub>MCK</sub> + 190 <sup>Note 4</sup>		1/f <sub>MCK</sub> + 190 <sup>Note 4</sup>		ns
		1.8 V (2.4 V <sup>Note 2</sup> ) ≤ V <sub>DD</sub> < 3.3 V, 1.6 V ≤ V <sub>b</sub> ≤ 2.0 V <sup>Note 3</sup> , C <sub>b</sub> = 100 pF, R <sub>b</sub> = 5.5 kΩ	1/f <sub>MCK</sub> + 190 <sup>Note 4</sup>		1/f <sub>MCK</sub> + 190 <sup>Note 4</sup>		1/f <sub>MCK</sub> + 190 <sup>Note 4</sup>		ns
Data hold time (transmission)	t <sub>HD:DAT</sub>	4.0 V ≤ V <sub>DD</sub> ≤ 5.5 V, 2.7 V ≤ V <sub>b</sub> ≤ 4.0 V, C <sub>b</sub> = 50 pF, R <sub>b</sub> = 2.7 kΩ	0	305	0	305	0	305	ns
		2.7 V ≤ V <sub>DD</sub> < 4.0 V, 2.3 V ≤ V <sub>b</sub> ≤ 2.7 V, C <sub>b</sub> = 50 pF, R <sub>b</sub> = 2.7 kΩ	0	305	0	305	0	305	ns
		4.0 V ≤ V <sub>DD</sub> ≤ 5.5 V, 2.7 V ≤ V <sub>b</sub> ≤ 4.0 V, C <sub>b</sub> = 100 pF, R <sub>b</sub> = 2.8 kΩ	0	355	0	355	0	355	ns
		2.7 V ≤ V <sub>DD</sub> < 4.0 V, 2.3 V ≤ V <sub>b</sub> ≤ 2.7 V, C <sub>b</sub> = 100 pF, R <sub>b</sub> = 2.7 kΩ	0	355	0	355	0	355	ns
		1.8 V (2.4 V <sup>Note 2</sup> ) ≤ V <sub>DD</sub> < 3.3 V, 1.6 V ≤ V <sub>b</sub> ≤ 2.0 V <sup>Note 3</sup> , C <sub>b</sub> = 100 pF, R <sub>b</sub> = 5.5 kΩ	0	405	0	405	0	405	ns

- Notes**
1. The value must also be equal to or less than f<sub>MCK</sub>/4.
  2. Condition in HS (high-speed main) mode
  3. Use it with V<sub>DD</sub> ≥ V<sub>b</sub>.
  4. Set the f<sub>MCK</sub> value to keep the hold time of SCLr = "L" and SCLr = "H".

**Caution** Select the TTL input buffer and the N-ch open drain output (V<sub>DD</sub> tolerance) mode for the SDAr pin and the N-ch open drain output (V<sub>DD</sub> tolerance) mode for the SCLr pin by using port input mode register g (PIMg) and port output mode register g (POMg). For V<sub>IH</sub> and V<sub>IL</sub>, see the DC characteristics with TTL input buffer selected.

(Remarks are listed on the next page.)

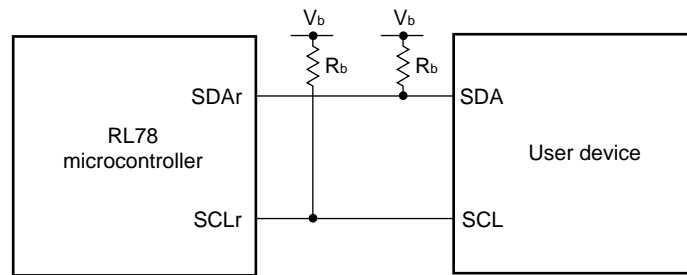
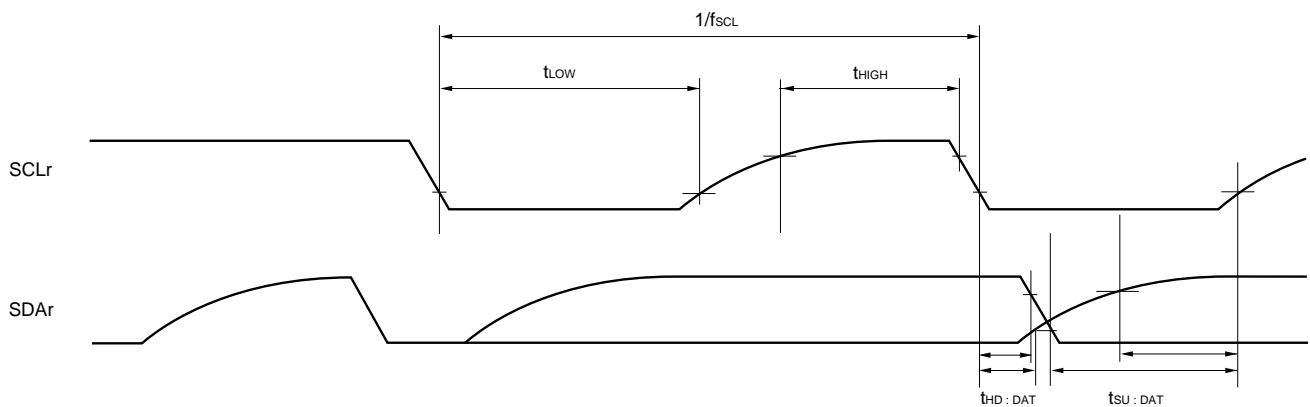
Simplified I<sup>2</sup>C mode connection diagram (during communication at different potential)Simplified I<sup>2</sup>C mode serial transfer timing (during communication at different potential)

- Remarks 1.**  $R_b[\Omega]$ : Communication line (SDAr, SCLr) pull-up resistance,  $C_b[F]$ : Communication line (SDAr, SCLr) load capacitance,  $V_b[V]$ : Communication line voltage
- 2.** r: IIC number (r = 00, 10), g: PIM, POM number (g = 0, 1)
- 3.**  $f_{MCK}$ : Serial array unit operation clock frequency  
(Operation clock to be set by the CKSmn bit of serial mode register mn (SMRmn).  
m: Unit number, n: Channel number (mn = 00, 02)

## 2.5.2 Serial interface IICA

(1) I<sup>2</sup>C standard mode (1/2) $(T_A = -40$  to  $+85^\circ\text{C}$ ,  $1.6\text{ V} \leq V_{DD} \leq 5.5\text{ V}$ ,  $V_{SS} = 0\text{ V}$ )

Parameter	Symbol	Conditions	HS (high-speed main) Mode		LS (low-speed main) Mode		LV (low-voltage main) Mode		Unit	
			MIN.	MAX.	MIN.	MAX.	MIN.	MAX.		
SCLA0 clock frequency	$f_{SCL}$	Normal mode: $f_{CLK} \geq 1\text{ MHz}$	$2.7\text{ V} \leq V_{DD} \leq 5.5\text{ V}$	0	100	0	100	0	100	kHz
			$1.8\text{ V} (2.4\text{ V}^{\text{Note 3}}) \leq V_{DD} \leq 5.5\text{ V}$	0	100	0	100	0	100	kHz
			$1.6\text{ V} \leq V_{DD} \leq 5.5\text{ V}$	–	–	–	–	0	100	kHz
Setup time of restart condition	$t_{SU:STA}$	$2.7\text{ V} \leq V_{DD} \leq 5.5\text{ V}$	4.7		4.7		4.7		$\mu\text{s}$	
		$1.8\text{ V} (2.4\text{ V}^{\text{Note 3}}) \leq V_{DD} \leq 5.5\text{ V}$	4.7		4.7		4.7		$\mu\text{s}$	
		$1.6\text{ V} \leq V_{DD} \leq 5.5\text{ V}$	–	–	–	–	4.7		$\mu\text{s}$	
Hold time <sup>Note 1</sup>	$t_{HD:STA}$	$2.7\text{ V} \leq V_{DD} \leq 5.5\text{ V}$	4.0		4.0		4.0		$\mu\text{s}$	
		$1.8\text{ V} (2.4\text{ V}^{\text{Note 3}}) \leq V_{DD} \leq 5.5\text{ V}$	4.0		4.0		4.0		$\mu\text{s}$	
		$1.6\text{ V} \leq V_{DD} \leq 5.5\text{ V}$	–	–	–	–	4.0		$\mu\text{s}$	
Hold time when SCLA0 = "L"	$t_{LOW}$	$2.7\text{ V} \leq V_{DD} \leq 5.5\text{ V}$	4.7		4.7		4.7		$\mu\text{s}$	
		$1.8\text{ V} (2.4\text{ V}^{\text{Note 3}}) \leq V_{DD} \leq 5.5\text{ V}$	4.7		4.7		4.7		$\mu\text{s}$	
		$1.6\text{ V} \leq V_{DD} \leq 5.5\text{ V}$	–	–	–	–	4.7		$\mu\text{s}$	
Hold time when SCLA0 = "H"	$t_{HIGH}$	$2.7\text{ V} \leq V_{DD} \leq 5.5\text{ V}$	4.0		4.0		4.0		$\mu\text{s}$	
		$1.8\text{ V} (2.4\text{ V}^{\text{Note 3}}) \leq V_{DD} \leq 5.5\text{ V}$	4.0		4.0		4.0		$\mu\text{s}$	
		$1.6\text{ V} \leq V_{DD} \leq 5.5\text{ V}$	–	–	–	–	4.0		$\mu\text{s}$	

(Notes, Caution and Remark are listed on the next page.)

(1) I<sup>2</sup>C standard mode (2/2)(T<sub>A</sub> = -40 to +85°C, 1.6 V ≤ V<sub>DD</sub> ≤ 5.5 V, V<sub>SS</sub> = 0 V)

Parameter	Symbol	Conditions	HS (high-speed main) Mode		LS (low-speed main) Mode		LV (low-voltage main) Mode		Unit
			MIN.	MAX.	MIN.	MAX.	MIN.	MAX.	
Data setup time (reception)	t <sub>SU:DAT</sub>	2.7 V ≤ V <sub>DD</sub> ≤ 5.5 V	250		250		250		ns
		1.8 V (2.4 V <sup>Note 3</sup> ) ≤ V <sub>DD</sub> ≤ 5.5 V	250		250		250		ns
		1.6 V ≤ V <sub>DD</sub> ≤ 5.5 V	–	–	–	–	250		ns
Data hold time (transmission) <sup>Note 2</sup>	t <sub>HD:DAT</sub>	2.7 V ≤ V <sub>DD</sub> ≤ 5.5 V	0	3.45	0	3.45	0	3.45	μs
		1.8 V (2.4 V <sup>Note 3</sup> ) ≤ V <sub>DD</sub> ≤ 5.5 V	0	3.45	0	3.45	0	3.45	μs
		1.6 V ≤ V <sub>DD</sub> ≤ 5.5 V	–	–	–	–	0	3.45	μs
Setup time of stop condition	t <sub>SU:STO</sub>	2.7 V ≤ V <sub>DD</sub> ≤ 5.5 V	4.0		4.0		4.0		μs
		1.8 V (2.4 V <sup>Note 3</sup> ) ≤ V <sub>DD</sub> ≤ 5.5 V	4.0		4.0		4.0		μs
		1.6 V ≤ V <sub>DD</sub> ≤ 5.5 V	–	–	–	–	4.0		μs
Bus-free time	t <sub>BUF</sub>	2.7 V ≤ V <sub>DD</sub> ≤ 5.5 V	4.7		4.7		4.7		μs
		1.8 V (2.4 V <sup>Note 3</sup> ) ≤ V <sub>DD</sub> ≤ 5.5 V	4.7		4.7		4.7		μs
		1.6 V ≤ V <sub>DD</sub> ≤ 5.5 V	–	–	–	–	4.7		μs

- Notes**
1. The first clock pulse is generated after this period when the start/restart condition is detected.
  2. The maximum value (MAX.) of t<sub>HD:DAT</sub> is during normal transfer and a wait state is inserted in the ACK (acknowledge) timing.
  3. Condition in HS (high-speed main) mode

**Caution** The values in the above table are applied even when bit 2 (PIOR2) in the peripheral I/O redirection register (PIOR) is 1. At this time, the pin characteristics (I<sub>OH1</sub>, I<sub>OL1</sub>, V<sub>OH1</sub>, V<sub>OL1</sub>) must satisfy the values in the redirect destination.

**Remark** The maximum value of C<sub>b</sub> (communication line capacitance) and the value of R<sub>b</sub> (communication line pull-up resistor) at that time in each mode are as follows.

Standard mode: C<sub>b</sub> = 400 pF, R<sub>b</sub> = 2.7 kΩ



(2) I<sup>2</sup>C fast mode(T<sub>A</sub> = -40 to +85°C, 1.6 V ≤ V<sub>DD</sub> ≤ 5.5 V, V<sub>SS</sub> = 0 V)

Parameter	Symbol	Conditions		HS (high-speed main) Mode		LS (low-speed main) Mode		LV (low-voltage main) Mode		Unit
				MIN.	MAX.	MIN.	MAX.	MIN.	MAX.	
SCLA0 clock frequency	f <sub>SCL</sub>	Fast mode: f <sub>CLK</sub> ≥ 3.5 MHz	2.7 V ≤ V <sub>DD</sub> ≤ 5.5 V	0	400	0	400	0	400	kHz
			1.8 V (2.4 V <sup>Note 3</sup> ) ≤ V <sub>DD</sub> ≤ 5.5 V	0	400	0	400	0	400	kHz
Setup time of restart condition	t <sub>SU:STA</sub>	2.7 V ≤ V <sub>DD</sub> ≤ 5.5 V		0.6		0.6		0.6		μs
		1.8 V (2.4 V <sup>Note 3</sup> ) ≤ V <sub>DD</sub> ≤ 5.5 V		0.6		0.6		0.6		μs
Hold time <sup>Note 1</sup>	t <sub>HD:STA</sub>	2.7 V ≤ V <sub>DD</sub> ≤ 5.5 V		0.6		0.6		0.6		μs
		1.8 V (2.4 V <sup>Note 3</sup> ) ≤ V <sub>DD</sub> ≤ 5.5 V		0.6		0.6		0.6		μs
Hold time when SCLA0 = "L"	t <sub>LOW</sub>	2.7 V ≤ V <sub>DD</sub> ≤ 5.5 V		1.3		1.3		1.3		μs
		1.8 V (2.4 V <sup>Note 3</sup> ) ≤ V <sub>DD</sub> ≤ 5.5 V		1.3		1.3		1.3		μs
Hold time when SCLA0 = "H"	t <sub>HIGH</sub>	2.7 V ≤ V <sub>DD</sub> ≤ 5.5 V		0.6		0.6		0.6		μs
		1.8 V (2.4 V <sup>Note 3</sup> ) ≤ V <sub>DD</sub> ≤ 5.5 V		0.6		0.6		0.6		μs
Data setup time (reception)	t <sub>SU:DAT</sub>	2.7 V ≤ V <sub>DD</sub> ≤ 5.5 V		100		100		100		ns
		1.8 V (2.4 V <sup>Note 3</sup> ) ≤ V <sub>DD</sub> ≤ 5.5 V		100		100		100		ns
Data hold time (transmission) <sup>Note 2</sup>	t <sub>HD:DAT</sub>	2.7 V ≤ V <sub>DD</sub> ≤ 5.5 V		0	0.9	0	0.9	0	0.9	μs
		1.8 V (2.4 V <sup>Note 3</sup> ) ≤ V <sub>DD</sub> ≤ 5.5 V		0	0.9	0	0.9	0	0.9	μs
Setup time of stop condition	t <sub>SU:STO</sub>	2.7 V ≤ V <sub>DD</sub> ≤ 5.5 V		0.6		0.6		0.6		μs
		1.8 V (2.4 V <sup>Note 3</sup> ) ≤ V <sub>DD</sub> ≤ 5.5 V		0.6		0.6		0.6		μs
Bus-free time	t <sub>BUF</sub>	2.7 V ≤ V <sub>DD</sub> ≤ 5.5 V		1.3		1.3		1.3		μs
		1.8 V (2.4 V <sup>Note 3</sup> ) ≤ V <sub>DD</sub> ≤ 5.5 V		1.3		1.3		1.3		μs

- Notes**
1. The first clock pulse is generated after this period when the start/restart condition is detected.
  2. The maximum value (MAX.) of t<sub>HD:DAT</sub> is during normal transfer and a wait state is inserted in the ACK (acknowledge) timing.
  3. Condition in HS (high-speed main) mode

**Caution** The values in the above table are applied even when bit 2 (PIOR2) in the peripheral I/O redirection register (PIOR) is 1. At this time, the pin characteristics (I<sub>OH1</sub>, I<sub>OL1</sub>, V<sub>OH1</sub>, V<sub>OL1</sub>) must satisfy the values in the redirect destination.

**Remark** The maximum value of C<sub>b</sub> (communication line capacitance) and the value of R<sub>b</sub> (communication line pull-up resistor) at that time in each mode are as follows.

Fast mode: C<sub>b</sub> = 320 pF, R<sub>b</sub> = 1.1 kΩ

**(3) I<sup>2</sup>C fast mode plus**

(T<sub>A</sub> = -40 to +85°C, 1.6 V ≤ V<sub>DD</sub> ≤ 5.5 V, V<sub>SS</sub> = 0 V)

Parameter	Symbol	Conditions		HS (high-speed main) Mode		LS (low-speed main) Mode		LV (low-voltage main) Mode		Unit
				MIN.	MAX.	MIN.	MAX.	MIN.	MAX.	
SCLA0 clock frequency	f <sub>SCL</sub>	Fast mode plus: f <sub>CLK</sub> ≥ 10 MHz	2.7 V ≤ V <sub>DD</sub> ≤ 5.5 V	0	1000	—	—	—	—	kHz
Setup time of restart condition	t <sub>SU:STA</sub>	2.7 V ≤ V <sub>DD</sub> ≤ 5.5 V		0.26	—	—	—	—	—	μs
Hold time <sup>Note 1</sup>	t <sub>HD:STA</sub>	2.7 V ≤ V <sub>DD</sub> ≤ 5.5 V		0.26	—	—	—	—	—	μs
Hold time when SCLA0 = "L"	t <sub>LOW</sub>	2.7 V ≤ V <sub>DD</sub> ≤ 5.5 V		0.5	—	—	—	—	—	μs
Hold time when SCLA0 = "H"	t <sub>HIGH</sub>	2.7 V ≤ V <sub>DD</sub> ≤ 5.5 V		0.26	—	—	—	—	—	μs
Data setup time (reception)	t <sub>SU:DAT</sub>	2.7 V ≤ V <sub>DD</sub> ≤ 5.5 V		50	—	—	—	—	—	ns
Data hold time (transmission) <sup>Note 2</sup>	t <sub>HD:DAT</sub>	2.7 V ≤ V <sub>DD</sub> ≤ 5.5 V		0	0.45	—	—	—	—	μs
Setup time of stop condition	t <sub>SU:STO</sub>	2.7 V ≤ V <sub>DD</sub> ≤ 5.5 V		0.26	—	—	—	—	—	μs
Bus-free time	t <sub>BUF</sub>	2.7 V ≤ V <sub>DD</sub> ≤ 5.5 V		0.5	—	—	—	—	—	μs

- Notes**
- The first clock pulse is generated after this period when the start/restart condition is detected.
  - The maximum value (MAX.) of t<sub>HD:DAT</sub> is during normal transfer and a wait state is inserted in the ACK (acknowledge) timing.

**Caution** The values in the above table are applied even when bit 2 (PIOR2) in the peripheral I/O redirection register (PIOR) is 1. At this time, the pin characteristics (I<sub>OH1</sub>, I<sub>OL1</sub>, V<sub>OH1</sub>, V<sub>OL1</sub>) must satisfy the values in the redirect destination.

**Remark** The maximum value of C<sub>b</sub> (communication line capacitance) and the value of R<sub>b</sub> (communication line pull-up resistor) at that time in each mode are as follows.

Fast mode plus: C<sub>b</sub> = 120 pF, R<sub>b</sub> = 1.1 kΩ

IICA serial transfer timing

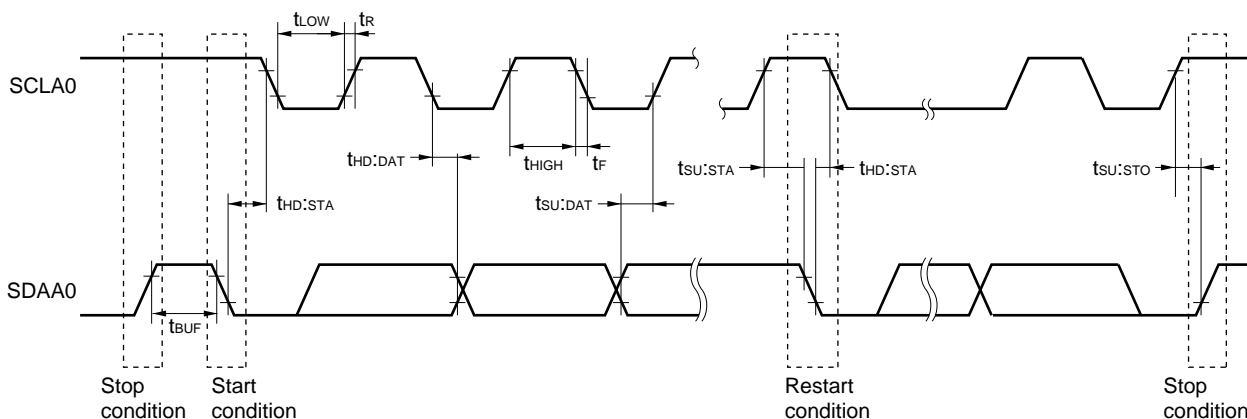

## 2.6 Analog Characteristics

### 2.6.1 A/D converter characteristics

#### Classification of A/D converter characteristics

Reference Voltage Input channel	Reference voltage (+) = AV <sub>REFP</sub> Reference voltage (-) = AV <sub>REFM</sub>	Reference voltage (+) = V <sub>DD</sub> Reference voltage (-) = V <sub>SS</sub>	Reference voltage (+) = V <sub>BGR</sub> Reference voltage (-) = AV <sub>REFM</sub>
ANI0, ANI1	–	See 2.6.1 (2).	See 2.6.1 (3).
ANI16 to ANI25	See 2.6.1 (1).		
Internal reference voltage Temperature sensor output voltage	See 2.6.1 (1).		–

(1) When reference voltage (+) = AV<sub>REFP</sub>/ANI0 (ADREFP1 = 0, ADREFP0 = 1), reference voltage (-) = AV<sub>REFM</sub>/ANI1 (ADREFM = 1), target pins: ANI16 to ANI25, internal reference voltage, and temperature sensor output voltage

(T<sub>A</sub> = -40 to +85°C, 1.6 V ≤ V<sub>DD</sub> ≤ 5.5 V, V<sub>SS</sub> = 0 V, Reference voltage (+) = AV<sub>REFP</sub>, Reference voltage (-) = AV<sub>REFM</sub> = 0 V)

Parameter	Symbol	Conditions	MIN.	TYP.	MAX.	Unit
Resolution	RES		8		10	bit
Overall error <sup>Note 1</sup>	AINL	10-bit resolution AV <sub>REFP</sub> = V <sub>DD</sub> <sup>Note 3</sup>	1.8 V ≤ AV <sub>REFP</sub> ≤ 5.5 V	1.2	±5.0	LSB
			1.6 V ≤ AV <sub>REFP</sub> ≤ 5.5 V <sup>Note 4</sup>	1.2	±8.5	LSB
Conversion time	t <sub>CONV</sub>	10-bit resolution Target pin: ANI16 to ANI25	3.6 V ≤ V <sub>DD</sub> ≤ 5.5 V	2.125	39	μs
			2.7 V ≤ V <sub>DD</sub> ≤ 5.5 V	3.1875	39	μs
			1.8 V ≤ V <sub>DD</sub> ≤ 5.5 V	17	39	μs
			1.6 V ≤ V <sub>DD</sub> ≤ 5.5 V	57	95	μs
		10-bit resolution Target pin: Internal reference voltage, and temperature sensor output voltage (HS (high-speed main) mode)	3.6 V ≤ V <sub>DD</sub> ≤ 5.5 V	2.375	39	μs
			2.7 V ≤ V <sub>DD</sub> ≤ 5.5 V	3.5625	39	μs
Zero-scale error <sup>Notes 1, 2</sup>	E <sub>ZS</sub>	10-bit resolution AV <sub>REFP</sub> = V <sub>DD</sub> <sup>Note 3</sup>	1.8 V ≤ AV <sub>REFP</sub> ≤ 5.5 V		±0.35	%FSR
			1.6 V ≤ AV <sub>REFP</sub> ≤ 5.5 V <sup>Note 4</sup>		±0.60	%FSR
Full-scale error <sup>Notes 1, 2</sup>	E <sub>FS</sub>	10-bit resolution AV <sub>REFP</sub> = V <sub>DD</sub> <sup>Note 3</sup>	1.8 V ≤ AV <sub>REFP</sub> ≤ 5.5 V		±0.35	%FSR
			1.6 V ≤ AV <sub>REFP</sub> ≤ 5.5 V <sup>Note 4</sup>		±0.60	%FSR
Integral linearity error <sup>Note 1</sup>	ILE	10-bit resolution AV <sub>REFP</sub> = V <sub>DD</sub> <sup>Note 3</sup>	1.8 V ≤ AV <sub>REFP</sub> ≤ 5.5 V		±3.5	LSB
			1.6 V ≤ AV <sub>REFP</sub> ≤ 5.5 V <sup>Note 4</sup>		±6.0	LSB
Differential linearity error <sup>Note 1</sup>	DLE	10-bit resolution AV <sub>REFP</sub> = V <sub>DD</sub> <sup>Note 3</sup>	1.8 V ≤ AV <sub>REFP</sub> ≤ 5.5 V		±2.0	LSB
			1.6 V ≤ AV <sub>REFP</sub> ≤ 5.5 V <sup>Note 4</sup>		±2.5	LSB
Analog input voltage	V <sub>AIN</sub>	ANI16 to ANI25	0		AV <sub>REFP</sub>	V
		Internal reference voltage (2.4 V ≤ V <sub>DD</sub> ≤ 5.5 V, HS (high-speed main) mode))			V <sub>BGR</sub> <sup>Note 5</sup>	V
		Temperature sensor output voltage (2.4 V ≤ V <sub>DD</sub> ≤ 5.5 V, HS (high-speed main) mode))			V <sub>TMPS25</sub> <sup>Note 5</sup>	V

(Notes are listed on the next page.)

- Notes**
1. Excludes quantization error ( $\pm 1/2$  LSB).
  2. This value is indicated as a ratio (%FSR) to the full-scale value.
  3. When  $AV_{REFP} < V_{DD}$ , the MAX. values are as follows.
 

Overall error:	Add $\pm 4$ LSB to the MAX. value when $AV_{REFP} = V_{DD}$ .
Zero-scale error/Full-scale error:	Add $\pm 0.2\%$ FSR to the MAX. value when $AV_{REFP} = V_{DD}$ .
Integral linearity error/ Differential linearity error:	Add $\pm 2$ LSB to the MAX. value when $AV_{REFP} = V_{DD}$ .
  4. Values when the conversion time is set to 57  $\mu$ s (min.) and 95  $\mu$ s (max.).
  5. See 2.6.2 Temperature sensor/internal reference voltage characteristics.

(2) When reference voltage (+) = V<sub>DD</sub> (ADREFP1 = 0, ADREFP0 = 0), reference voltage (-) = V<sub>SS</sub> (ADREFM = 0), target pins: ANI0, ANI1, ANI16 to ANI25, internal reference voltage, and temperature sensor output voltage

(T<sub>A</sub> = -40 to +85°C, 1.6 V ≤ V<sub>DD</sub> ≤ 5.5 V, V<sub>SS</sub> = 0 V, Reference voltage (+) = V<sub>DD</sub>, Reference voltage (-) = V<sub>SS</sub>)

Parameter	Symbol	Conditions		MIN.	TYP.	MAX.	Unit
Resolution	RES			8		10	bit
Overall error <sup>Notes 1, 2</sup>	AINL	10-bit resolution	1.8 V ≤ V <sub>DD</sub> ≤ 5.5 V		1.2	±7.0	LSB
			1.6 V ≤ V <sub>DD</sub> ≤ 5.5 V <sup>Note 3</sup>		1.2	±10.5	LSB
Conversion time	t <sub>CONV</sub>	10-bit resolution Target pin: ANI0, ANI1, ANI16 to ANI25 <sup>Note 3</sup>	3.6 V ≤ V <sub>DD</sub> ≤ 5.5 V	2.125		39	μs
			2.7 V ≤ V <sub>DD</sub> ≤ 5.5 V	3.1875		39	μs
			1.8 V ≤ V <sub>DD</sub> ≤ 5.5 V	17		39	μs
			1.6 V ≤ V <sub>DD</sub> ≤ 5.5 V	57		95	μs
		10-bit resolution Target pin: Internal reference voltage, and temperature sensor output voltage (HS (high-speed main) mode)	3.6 V ≤ V <sub>DD</sub> ≤ 5.5 V	2.375		39	μs
			2.7 V ≤ V <sub>DD</sub> ≤ 5.5 V	3.5625		39	μs
Zero-scale error <sup>Notes 1, 2</sup>	E <sub>ZS</sub>	10-bit resolution	1.8 V ≤ V <sub>DD</sub> ≤ 5.5 V			±0.60	%FSR
			1.6 V ≤ V <sub>DD</sub> ≤ 5.5 V <sup>Note 3</sup>			±0.85	%FSR
Full-scale error <sup>Notes 1, 2</sup>	E <sub>FS</sub>	10-bit resolution	1.8 V ≤ V <sub>DD</sub> ≤ 5.5 V			±0.60	%FSR
			1.6 V ≤ V <sub>DD</sub> ≤ 5.5 V <sup>Note 3</sup>			±0.85	%FSR
Integral linearity error <sup>Note 1</sup>	ILE	10-bit resolution	1.8 V ≤ V <sub>DD</sub> ≤ 5.5 V			±4.0	LSB
			1.6 V ≤ V <sub>DD</sub> ≤ 5.5 V <sup>Note 3</sup>			±6.5	LSB
Differential linearity error <sup>Note 1</sup>	DLE	10-bit resolution	1.8 V ≤ V <sub>DD</sub> ≤ 5.5 V			±2.0	LSB
			1.6 V ≤ V <sub>DD</sub> ≤ 5.5 V <sup>Note 3</sup>			±2.5	LSB
Analog input voltage	V <sub>AIN</sub>	ANI0, ANI1, ANI16 to ANI25		0		V <sub>DD</sub>	V
		Internal reference voltage (2.4 V ≤ V <sub>DD</sub> ≤ 5.5 V, HS (high-speed main) mode))		V <sub>BGR</sub> <sup>Note 4</sup>			V
		Temperature sensor output voltage (2.4 V ≤ V <sub>DD</sub> ≤ 5.5 V, HS (high-speed main) mode))		V <sub>TMPS25</sub> <sup>Note 4</sup>			V

- Notes**
1. Excludes quantization error ( $\pm 1/2$  LSB).
  2. This value is indicated as a ratio (%FSR) to the full-scale value.
  3. Values when the conversion time is set to 57  $\mu$ s (min.) and 95  $\mu$ s (max.).
  4. See 2.6.2 Temperature sensor/internal reference voltage characteristics.

(3) When reference voltage (+) = Internal reference voltage (ADREFP1 = 1, ADREFP0 = 0), reference voltage (-) = AVREFM/ANI1 (ADREFM = 1), target pins: ANI0, ANI16 to ANI25

(T<sub>A</sub> = -40 to +85°C, 2.4 V ≤ V<sub>DD</sub> ≤ 5.5 V, V<sub>SS</sub> = 0 V, Reference voltage (+) = V<sub>BGR</sub><sup>Note 3</sup>,  
Reference voltage (-) = AVREFM<sup>Note 4</sup> = 0 V, HS (high-speed main) mode)

Parameter	Symbol	Conditions		MIN.	TYP.	MAX.	Unit
Resolution	RES			8			bit
Conversion time	t <sub>CONV</sub>	8-bit resolution	2.4 V ≤ V <sub>DD</sub> ≤ 5.5 V	17		39	μs
Zero-scale error <sup>Notes 1, 2</sup>	E <sub>ZS</sub>	8-bit resolution	2.4 V ≤ V <sub>DD</sub> ≤ 5.5 V			±0.60	%FSR
Integral linearity error <sup>Note 1</sup>	ILE	8-bit resolution	2.4 V ≤ V <sub>DD</sub> ≤ 5.5 V			±2.0	LSB
Differential linearity error <sup>Note 1</sup>	DLE	8-bit resolution	2.4 V ≤ V <sub>DD</sub> ≤ 5.5 V			±1.0	LSB
Analog input voltage	V <sub>AIN</sub>			0		V <sub>BGR</sub> <sup>Note 3</sup>	V

**Notes** 1. Excludes quantization error (±1/2 LSB).

2. This value is indicated as a ratio (%FSR) to the full-scale value.

3. See 2.6.2 Temperature sensor/internal reference voltage characteristics.

4. When reference voltage (-) = V<sub>SS</sub>, the MAX. values are as follows.

Zero-scale error: Add ±0.35%FSR to the AVREFM MAX. value.

Integral linearity error: Add ±0.5 LSB to the AVREFM MAX. value.

Differential linearity error: Add ±0.2 LSB to the AVREFM MAX. value.

## 2.6.2 Temperature sensor /internal reference voltage characteristics

(T<sub>A</sub> = -40 to +85°C, 2.4 V ≤ V<sub>DD</sub> ≤ 5.5 V, V<sub>SS</sub> = 0 V, HS (high-speed main) mode)

Parameter	Symbol	Conditions	MIN.	TYP.	MAX.	Unit
Temperature sensor output voltage	V <sub>TMPS25</sub>	ADS register = 80H, T <sub>A</sub> = +25°C		1.05		V
Internal reference output voltage	V <sub>BGR</sub>	ADS register = 81H	1.38	1.45	1.5	V
Temperature coefficient	F <sub>VTMPS</sub>	Temperature sensor that depends on the temperature		-3.6		mV/°C
Operation stabilization wait time	t <sub>AMP</sub>				5	μs

2.6.3 Comparator characteristics

(T<sub>A</sub> = -40 to +85°C, 1.6 V ≤ V<sub>DD</sub> ≤ 5.5 V, V<sub>SS</sub> = 0 V)

Parameter	Symbol	Conditions	MIN.	TYP.	MAX.	Unit	
Input voltage range	Ivref		0		V <sub>DD</sub> - 1.4	V	
	Ivcmp		-0.3		V <sub>DD</sub> + 0.3	V	
Output delay	td	V <sub>DD</sub> = 3.0 V Input slew rate > 50 mV/μs	Comparator high-speed mode, standard mode			1.2	μs
			Comparator high-speed mode, window mode			2.0	μs
			Comparator low-speed mode, standard mode		3.0	5.0	μs
High-electric-potential reference voltage	VTW+	Comparator high-speed mode, window mode	0.66V <sub>DD</sub>	0.76V <sub>DD</sub>	0.86V <sub>DD</sub>	V	
Low-electric-potential reference voltage	VTW-	Comparator high-speed mode, window mode	0.14V <sub>DD</sub>	0.24V <sub>DD</sub>	0.34V <sub>DD</sub>	V	
Operation stabilization wait time	t <sub>CMP</sub>		100			μs	
Internal reference output voltage <sup>Note</sup>	V <sub>BGR</sub>	2.4 V ≤ V <sub>DD</sub> ≤ 5.5 V, HS (high-speed main) mode	1.38	1.45	1.50	V	

**Note** Cannot be used in LS (low-speed main) mode, LV (low-voltage main) mode, subsystem clock operation, and STOP mode.

2.6.4 POR circuit characteristics

(T<sub>A</sub> = -40 to +85°C, V<sub>SS</sub> = 0 V)

Parameter	Symbol	Conditions	MIN.	TYP.	MAX.	Unit
Detection voltage	V <sub>POR</sub>	When power supply rises	1.47	1.51	1.55	V
	V <sub>PDR</sub>	When power supply falls	1.46	1.50	1.54	V
Minimum pulse width <sup>Note</sup>	T <sub>PW</sub>		300			μs

**Note** This is the time required for the POR circuit to execute a reset operation when V<sub>DD</sub> falls below V<sub>PDR</sub>. When the microcontroller enters STOP mode and when the main system clock (f<sub>MAIN</sub>) has been stopped by setting bit 0 (HIOSTOP) and bit 7 (MSTOP) of the clock operation status control register (CSC), this is the time required for the POR circuit to execute a reset operation between when V<sub>DD</sub> falls below 0.7 V and when V<sub>DD</sub> rises to V<sub>POR</sub> or higher.

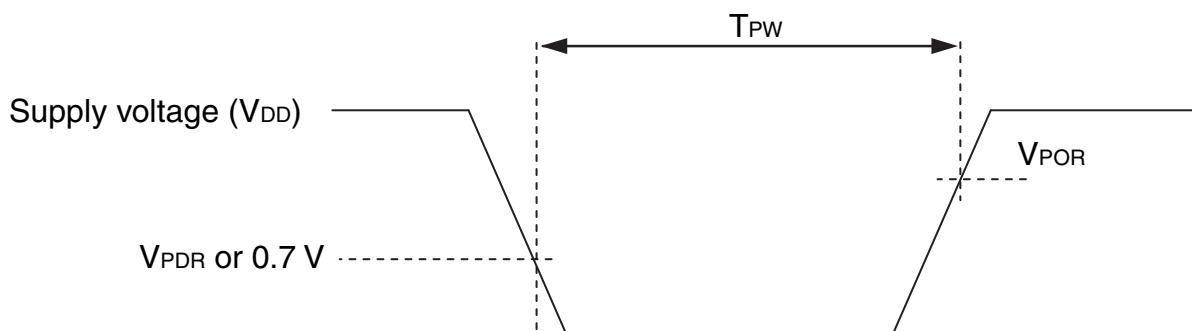

## 2.6.5 LVD circuit characteristics

**LVD Detection Voltage of Reset Mode and Interrupt Mode**(T<sub>A</sub> = -40 to +85°C, V<sub>PDR</sub> ≤ V<sub>DD</sub> ≤ 5.5 V, V<sub>SS</sub> = 0 V)

Parameter		Symbol	Conditions	MIN.	TYP.	MAX.	Unit
Detection voltage	Supply voltage level	V <sub>LVD0</sub>	When power supply rises	3.98	4.06	4.14	V
			When power supply falls	3.90	3.98	4.06	V
		V <sub>LVD1</sub>	When power supply rises	3.68	3.75	3.82	V
			When power supply falls	3.60	3.67	3.74	V
		V <sub>LVD2</sub>	When power supply rises	3.07	3.13	3.19	V
			When power supply falls	3.00	3.06	3.12	V
		V <sub>LVD3</sub>	When power supply rises	2.96	3.02	3.08	V
			When power supply falls	2.90	2.96	3.02	V
		V <sub>LVD4</sub>	When power supply rises	2.86	2.92	2.97	V
			When power supply falls	2.80	2.86	2.91	V
		V <sub>LVD5</sub>	When power supply rises	2.76	2.81	2.87	V
			When power supply falls	2.70	2.75	2.81	V
		V <sub>LVD6</sub>	When power supply rises	2.66	2.71	2.76	V
			When power supply falls	2.60	2.65	2.70	V
		V <sub>LVD7</sub>	When power supply rises	2.56	2.61	2.66	V
			When power supply falls	2.50	2.55	2.60	V
		V <sub>LVD8</sub>	When power supply rises	2.45	2.50	2.55	V
			When power supply falls	2.40	2.45	2.50	V
		V <sub>LVD9</sub>	When power supply rises	2.05	2.09	2.13	V
			When power supply falls	2.00	2.04	2.08	V
		V <sub>LVD10</sub>	When power supply rises	1.94	1.98	2.02	V
			When power supply falls	1.90	1.94	1.98	V
		V <sub>LVD11</sub>	When power supply rises	1.84	1.88	1.91	V
			When power supply falls	1.80	1.84	1.87	V
V <sub>LVD12</sub>	When power supply rises	1.74	1.77	1.81	V		
	When power supply falls	1.70	1.73	1.77	V		
V <sub>LVD13</sub>	When power supply rises	1.64	1.67	1.70	V		
	When power supply falls	1.60	1.63	1.66	V		
Minimum pulse width	t <sub>LW</sub>		300			μs	
Detection delay time					300	μs	

**LVD Detection Voltage of Interrupt & Reset Mode**(T<sub>A</sub> = -40 to +85°C, V<sub>PDR</sub> ≤ V<sub>DD</sub> ≤ 5.5 V, V<sub>SS</sub> = 0 V)

Parameter	Symbol	Conditions	MIN.	TYP.	MAX.	Unit	
Interrupt and reset mode	V <sub>LVD13</sub>	V <sub>POC2</sub> , V <sub>POC1</sub> , V <sub>POC0</sub> = 0, 0, 0, falling reset voltage	1.60	1.63	1.66	V	
	V <sub>LVD12</sub>	LVIS1, LVIS0 = 1, 0	Rising release reset voltage	1.74	1.77	1.81	V
			Falling interrupt voltage	1.70	1.73	1.77	V
	V <sub>LVD11</sub>	LVIS1, LVIS0 = 0, 1	Rising release reset voltage	1.84	1.88	1.91	V
			Falling interrupt voltage	1.80	1.84	1.87	V
	V <sub>LVD4</sub>	LVIS1, LVIS0 = 0, 0	Rising release reset voltage	2.86	2.92	2.97	V
			Falling interrupt voltage	2.80	2.86	2.91	V
	V <sub>LVD11</sub>	V <sub>POC2</sub> , V <sub>POC1</sub> , V <sub>POC0</sub> = 0, 0, 1, falling reset voltage	1.80	1.84	1.87	V	
	V <sub>LVD10</sub>	LVIS1, LVIS0 = 1, 0	Rising release reset voltage	1.94	1.98	2.02	V
			Falling interrupt voltage	1.90	1.94	1.98	V
	V <sub>LVD9</sub>	LVIS1, LVIS0 = 0, 1	Rising release reset voltage	2.05	2.09	2.13	V
			Falling interrupt voltage	2.00	2.04	2.08	V
	V <sub>LVD2</sub>	LVIS1, LVIS0 = 0, 0	Rising release reset voltage	3.07	3.13	3.19	V
			Falling interrupt voltage	3.00	3.06	3.12	V
	V <sub>LVD8</sub>	V <sub>POC2</sub> , V <sub>POC1</sub> , V <sub>POC0</sub> = 0, 1, 0, falling reset voltage	2.40	2.45	2.50	V	
	V <sub>LVD7</sub>	LVIS1, LVIS0 = 1, 0	Rising release reset voltage	2.56	2.61	2.66	V
			Falling interrupt voltage	2.50	2.55	2.60	V
	V <sub>LVD6</sub>	LVIS1, LVIS0 = 0, 1	Rising release reset voltage	2.66	2.71	2.76	V
			Falling interrupt voltage	2.60	2.65	2.70	V
	V <sub>LVD1</sub>	LVIS1, LVIS0 = 0, 0	Rising release reset voltage	3.68	3.75	3.82	V
			Falling interrupt voltage	3.60	3.67	3.74	V
	V <sub>LVD5</sub>	V <sub>POC2</sub> , V <sub>POC1</sub> , V <sub>POC0</sub> = 0, 1, 1, falling reset voltage	2.70	2.75	2.81	V	
	V <sub>LVD4</sub>	LVIS1, LVIS0 = 1, 0	Rising release reset voltage	2.86	2.92	2.97	V
			Falling interrupt voltage	2.80	2.86	2.91	V
V <sub>LVD3</sub>	LVIS1, LVIS0 = 0, 1	Rising release reset voltage	2.96	3.02	3.08	V	
		Falling interrupt voltage	2.90	2.96	3.02	V	
V <sub>LVD0</sub>	LVIS1, LVIS0 = 0, 0	Rising release reset voltage	3.98	4.06	4.14	V	
		Falling interrupt voltage	3.90	3.98	4.06	V	

**2.6.6 Supply voltage rising slope characteristics**(T<sub>A</sub> = -40 to +85°C, V<sub>SS</sub> = 0 V)

Parameter	Symbol	Conditions	MIN.	TYP.	MAX.	Unit
V <sub>DD</sub> rising slope	SV <sub>DD</sub>				54	V/ms

**Caution** Make sure to keep the internal reset state by the LVD circuit or an external reset until V<sub>DD</sub> reaches the operating voltage range shown in 2.4 AC Characteristics.



## 2.7 LCD Characteristics

## 2.7.1 External resistance division method

## (1) Static display mode

( $T_A = -40$  to  $+85^\circ\text{C}$ ,  $V_{L4} (\text{MIN.}) \leq V_{DD} \leq 5.5 \text{ V}$ ,  $V_{SS} = 0 \text{ V}$ )

Parameter	Symbol	Conditions	MIN.	TYP.	MAX.	Unit
LCD drive voltage	$V_{L4}$		2.0		$V_{DD}$	V

## (2) 1/2 bias method, 1/4 bias method

( $T_A = -40$  to  $+85^\circ\text{C}$ ,  $V_{L4} (\text{MIN.}) \leq V_{DD} \leq 5.5 \text{ V}$ ,  $V_{SS} = 0 \text{ V}$ )

Parameter	Symbol	Conditions	MIN.	TYP.	MAX.	Unit
LCD drive voltage	$V_{L4}$		2.7		$V_{DD}$	V

## (3) 1/3 bias method

( $T_A = -40$  to  $+85^\circ\text{C}$ ,  $V_{L4} (\text{MIN.}) \leq V_{DD} \leq 5.5 \text{ V}$ ,  $V_{SS} = 0 \text{ V}$ )

Parameter	Symbol	Conditions	MIN.	TYP.	MAX.	Unit
LCD drive voltage	$V_{L4}$		2.5		$V_{DD}$	V

## 2.7.2 Internal voltage boosting method

## (1) 1/3 bias method

(T<sub>A</sub> = -40 to +85°C, 1.8 V ≤ V<sub>DD</sub> ≤ 5.5 V, V<sub>SS</sub> = 0 V)

Parameter	Symbol	Conditions	MIN.	TYP.	MAX.	Unit	
LCD output voltage variation range	V <sub>L1</sub>	C1 to C4 <sup>Note 1</sup> = 0.47 μF <sup>Note 2</sup>	VLCD = 04H	0.90	1.00	1.08	V
			VLCD = 05H	0.95	1.05	1.13	V
			VLCD = 06H	1.00	1.10	1.18	V
			VLCD = 07H	1.05	1.15	1.23	V
			VLCD = 08H	1.10	1.20	1.28	V
			VLCD = 09H	1.15	1.25	1.33	V
			VLCD = 0AH	1.20	1.30	1.38	V
			VLCD = 0BH	1.25	1.35	1.43	V
			VLCD = 0CH	1.30	1.40	1.48	V
			VLCD = 0DH	1.35	1.45	1.53	V
			VLCD = 0EH	1.40	1.50	1.58	V
			VLCD = 0FH	1.45	1.55	1.63	V
			VLCD = 10H	1.50	1.60	1.68	V
			VLCD = 11H	1.55	1.65	1.73	V
VLCD = 12H	1.60	1.70	1.78	V			
VLCD = 13H	1.65	1.75	1.83	V			
Doubler output voltage	V <sub>L2</sub>	C1 to C4 <sup>Note 1</sup> = 0.47 μF	2 V <sub>L1</sub> - 0.10	2 V <sub>L1</sub>	2 V <sub>L1</sub>	V	
Tripler output voltage	V <sub>L4</sub>	C1 to C4 <sup>Note 1</sup> = 0.47 μF	3 V <sub>L1</sub> - 0.15	3 V <sub>L1</sub>	3 V <sub>L1</sub>	V	
Reference voltage setup time <sup>Note 2</sup>	t <sub>WAIT1</sub>		5			ms	
Voltage boost wait time <sup>Note 3</sup>	t <sub>WAIT2</sub>	C1 to C4 <sup>Note 1</sup> = 0.47 μF	500			ms	

**Notes** 1. This is a capacitor that is connected between voltage pins used to drive the LCD.

C1: A capacitor connected between CAPH and CAPL

C2: A capacitor connected between V<sub>L1</sub> and GND

C3: A capacitor connected between V<sub>L2</sub> and GND

C4: A capacitor connected between V<sub>L4</sub> and GND

C1 = C2 = C3 = C4 = 0.47 μF ± 30 %

- This is the time required to wait from when the reference voltage is specified by using the VLCD register (or when the internal voltage boosting method is selected (by setting the MDSET1 and MDSET0 bits of the LCDM0 register to 01B) if the default value reference voltage is used) until voltage boosting starts (VLCON = 1).
- This is the wait time from when voltage boosting is started (VLCON = 1) until display is enabled (LCDON = 1).

**(2) 1/4 bias method**(T<sub>A</sub> = -40 to +85°C, 1.8 V ≤ V<sub>DD</sub> ≤ 5.5 V, V<sub>SS</sub> = 0 V)

Parameter	Symbol	Conditions	MIN.	TYP.	MAX.	Unit	
LCD output voltage variation range	V <sub>L1</sub>	C1 to C5 <sup>Note 1</sup> = 0.47 μF <sup>Note 2</sup>	VLCD = 04H	0.90	1.00	1.08	V
			VLCD = 05H	0.95	1.05	1.13	V
			VLCD = 06H	1.00	1.10	1.18	V
			VLCD = 07H	1.05	1.15	1.23	V
			VLCD = 08H	1.10	1.20	1.28	V
			VLCD = 09H	1.15	1.25	1.33	V
			VLCD = 0AH	1.20	1.30	1.38	V
Doubler output voltage	V <sub>L2</sub>	C1 to C5 <sup>Note 1</sup> = 0.47 μF	2 V <sub>L1</sub> -0.08	2 V <sub>L1</sub>	2 V <sub>L1</sub>	V	
Tripler output voltage	V <sub>L3</sub>	C1 to C5 <sup>Note 1</sup> = 0.47 μF	3 V <sub>L1</sub> -0.12	3 V <sub>L1</sub>	3 V <sub>L1</sub>	V	
Quadruply output voltage	V <sub>L4</sub>	C1 to C5 <sup>Note 1</sup> = 0.47 μF	4 V <sub>L1</sub> -0.16	4 V <sub>L1</sub>	4 V <sub>L1</sub>	V	
Reference voltage setup time <sup>Note 2</sup>	t <sub>WAIT1</sub>		5			ms	
Voltage boost wait time <sup>Note 3</sup>	t <sub>WAIT2</sub>	C1 to C5 <sup>Note 1</sup> = 0.47 μF	500			ms	

**Notes** 1. This is a capacitor that is connected between voltage pins used to drive the LCD.

C1: A capacitor connected between CAPH and CAPL

C2: A capacitor connected between V<sub>L1</sub> and GNDC3: A capacitor connected between V<sub>L2</sub> and GNDC4: A capacitor connected between V<sub>L3</sub> and GNDC5: A capacitor connected between V<sub>L4</sub> and GND

C1 = C2 = C3 = C4 = C5 = 0.47 μF ± 30%

2. This is the time required to wait from when the reference voltage is specified by using the VLCD register (or when the internal voltage boosting method is selected (by setting the MDSET1 and MDSET0 bits of the LCDM0 register to 01B) if the default value reference voltage is used) until voltage boosting starts (VLCON = 1).

3. This is the wait time from when voltage boosting is started (VLCON = 1) until display is enabled (LCDON = 1).

## 2.7.3 Capacitor split method

**(1) 1/3 bias method**(T<sub>A</sub> = -40 to +85°C, 2.2 V ≤ V<sub>D</sub> ≤ 5.5 V, V<sub>SS</sub> = 0 V)

Parameter	Symbol	Conditions	MIN.	TYP.	MAX.	Unit
V <sub>L4</sub> voltage	V <sub>L4</sub>	C1 to C4 = 0.47 μF <sup>Note 2</sup>		V <sub>DD</sub>		V
V <sub>L2</sub> voltage	V <sub>L2</sub>	C1 to C4 = 0.47 μF <sup>Note 2</sup>	2/3 V <sub>L4</sub> - 0.1	2/3 V <sub>L4</sub>	2/3 V <sub>L4</sub> + 0.1	V
V <sub>L1</sub> voltage	V <sub>L1</sub>	C1 to C4 = 0.47 μF <sup>Note 2</sup>	1/3 V <sub>L4</sub> - 0.1	1/3 V <sub>L4</sub>	1/3 V <sub>L4</sub> + 0.1	V
Capacitor split wait time <sup>Note 1</sup>	t <sub>WAIT</sub>		100			ms

**Notes** 1. This is the wait time from when voltage bucking is started (VLCON = 1) until display is enabled (LCDON = 1).

2. This is a capacitor that is connected between voltage pins used to drive the LCD.

C1: A capacitor connected between CAPH and CAPL

C2: A capacitor connected between V<sub>L1</sub> and GNDC3: A capacitor connected between V<sub>L2</sub> and GNDC4: A capacitor connected between V<sub>L4</sub> and GND

C1 = C2 = C3 = C4 = 0.47 μF ± 30%

<R> 2.8 RAM Data Retention Characteristics

(T<sub>A</sub> = -40 to +85°C)

Parameter	Symbol	Conditions	MIN.	TYP.	MAX.	Unit
Data retention supply voltage	V <sub>DDDR</sub>		1.46 <sup>Note</sup>		5.5	V

<R> **Note** This depends on the POR detection voltage. For a falling voltage, data in RAM are retained until the voltage reaches the level that triggers a POR reset but not once it reaches the level at which a POR reset is generated.

<R> **Caution** Data in RAM are not retained if the CPU operates outside the specified operating voltage range. Therefore, place the CPU in STOP mode before the operating voltage drops below the specified range.

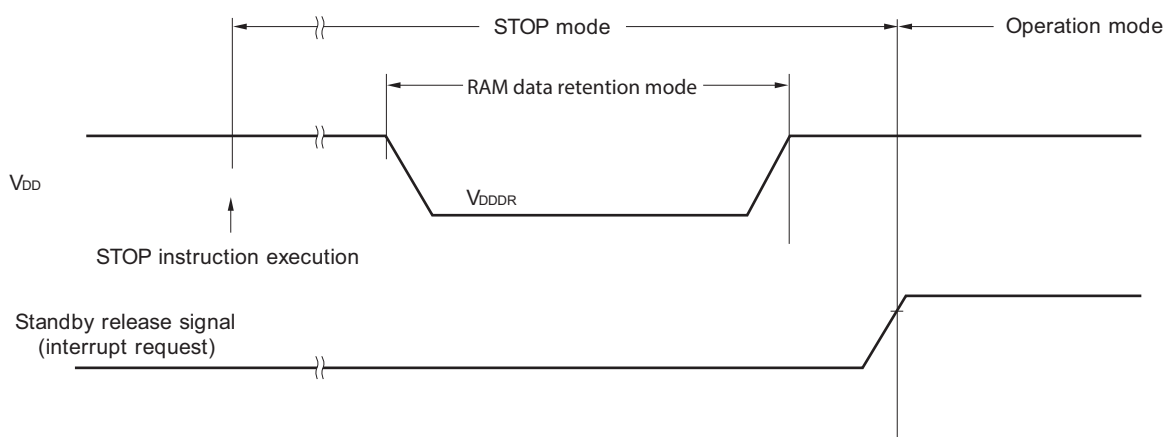

2.9 Flash Memory Programming Characteristics

(T<sub>A</sub> = -40 to +85°C, 1.8 V ≤ V<sub>DD</sub> ≤ 5.5 V, V<sub>SS</sub> = 0 V)

Parameter	Symbol	Conditions	MIN.	TYP.	MAX.	Unit
System clock frequency	f <sub>CLK</sub>	1.8 V ≤ V <sub>DD</sub> ≤ 5.5 V	1		24	MHz
Number of code flash rewrites <sup>Notes 1, 2, 3</sup>	C <sub>erwr</sub>	Retained for 20 years T <sub>A</sub> = 85°C	1,000			Times
Number of data flash rewrites <sup>Notes 1, 2, 3</sup>		Retained for 1 year T <sub>A</sub> = 25°C		1,000,000		
		Retained for 5 years T <sub>A</sub> = 85°C	100,000			
		Retained for 20 years T <sub>A</sub> = 85°C	10,000			

**Notes 1.** 1 erase + 1 write after the erase is regarded as 1 rewrite. The retaining years are until next rewrite after the rewrite.

**2.** When using flash memory programmer and Renesas Electronics self programming library

**3.** This characteristic indicates the flash memory characteristic and based on Renesas Electronics reliability test.

**Remark** When updating data multiple times, use the flash memory as one for updating data.

2.10 Dedicated Flash Memory Programmer Communication (UART)

(T<sub>A</sub> = -40 to +85°C, 1.8 V ≤ V<sub>DD</sub> ≤ 5.5 V, V<sub>SS</sub> = 0 V)

Parameter	Symbol	Conditions	MIN.	TYP.	MAX.	Unit
Transfer rate		During serial programming	115,200		1,000,000	bps

### 2.11 Timing Specifications for Switching Flash Memory Programming Modes

(T<sub>A</sub> = -40 to +85°C, 1.8 V ≤ V<sub>DD</sub> ≤ 5.5 V, V<sub>SS</sub> = 0 V)

Parameter	Symbol	Conditions	MIN.	TYP.	MAX.	Unit
Time to complete the communication for the initial setting after the external reset is released	t <sub>SUINIT</sub>	POR and LVD reset must be released before the external reset is released.			100	ms
Time to release the external reset after the TOOL0 pin is set to the low level	t <sub>SU</sub>	POR and LVD reset must be released before the external reset is released.	10			μs
Time to hold the TOOL0 pin at the low level after the external reset is released (excluding the processing time of the firmware to control the flash memory)	t <sub>HD</sub>	POR and LVD reset must be released before the external reset is released.	1			ms

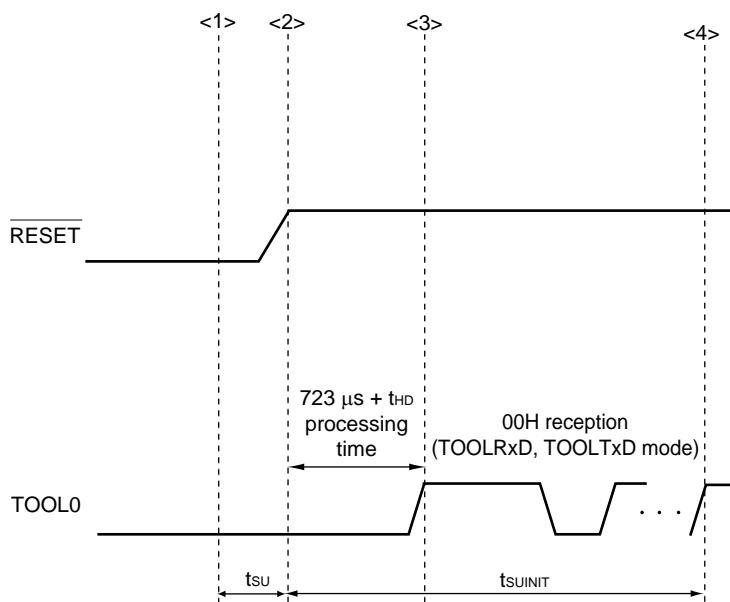

- <1> The low level is input to the TOOL0 pin.
- <2> The external reset is released (POR and LVD reset must be released before the external reset is released.).
- <3> The TOOL0 pin is set to the high level.
- <4> Setting of the flash memory programming mode by UART reception and completion the baud rate setting.

**Remark** t<sub>SUINIT</sub>: Communication for the initial setting must be completed within 100 ms after the external reset is released during this period.

t<sub>SU</sub>: Time to release the external reset after the TOOL0 pin is set to the low level

t<sub>HD</sub>: Time to hold the TOOL0 pin at the low level after the external reset is released (excluding the processing time of the firmware to control the flash memory)

### 3. ELECTRICAL SPECIFICATIONS (G: INDUSTRIAL APPLICATIONS $T_A = -40$ to $+105^\circ\text{C}$ )

This chapter describes the following electrical specifications.

Target products G: Industrial applications  $T_A = -40$  to  $+105^\circ\text{C}$

R5F10WLAGFB, R5F10WLCGFB, R5F10WLDGFB,  
R5F10WLEGFB, R5F10WLFGFB, R5F10WLGGB,  
R5F10WMAGFB, R5F10WMCGB, R5F10WMDGFB,  
R5F10WMEGFB, R5F10WMFGFB, R5F10WMGGFB

- Cautions**
1. The RL78/L13 microcontrollers have an on-chip debug function, which is provided for development and evaluation. Do not use the on-chip debug function in products designated for mass production, because the guaranteed number of rewritable times of the flash memory may be exceeded when this function is used, and product reliability therefore cannot be guaranteed. Renesas Electronics is not liable for problems occurring when the on-chip debug function is used.
  2. The pins mounted depend on the product. See 2.1 Port Function to 2.2.1 With functions for each product in the RL78/L13 User's Manual.
  3. Consult Renesas salesperson and distributor for derating when the product is used at  $T_A = +85^\circ\text{C}$  to  $+105^\circ\text{C}$ . Note that derating means "systematically lowering the load from the rated value to improve reliability".

<R> **Remark** When RL78/L13 is used in the range of  $T_A = -40$  to  $+85^\circ\text{C}$ , see **CHAPTER 2 ELECTRICAL SPECIFICATIONS ( $T_A = -40$  to  $+85^\circ\text{C}$ )**.

“G: Industrial applications ( $T_A = -40$  to  $+105^\circ\text{C}$ ) differ from “A: Consumer applications” in function as follows:

Fields of Application	A: Consumer applications	G: Industrial applications
Operating ambient temperature	$T_A = -40$ to $+85^\circ\text{C}$	$T_A = -40$ to $+105^\circ\text{C}$
Operation mode operating voltage range	HS (high-speed main) mode: $2.7\text{ V} \leq V_{DD} \leq 5.5\text{ V}@1\text{ MHz}$ to $24\text{ MHz}$ $2.4\text{ V} \leq V_{DD} \leq 5.5\text{ V}@1\text{ MHz}$ to $16\text{ MHz}$ LS (low-speed main) mode: $1.8\text{ V} \leq V_{DD} \leq 5.5\text{ V}@1\text{ MHz}$ to $8\text{ MHz}$ LV (low-voltage main) mode: $1.6\text{ V} \leq V_{DD} \leq 5.5\text{ V}@1\text{ MHz}$ to $4\text{ MHz}$	HS (high-speed main) mode only: $2.7\text{ V} \leq V_{DD} \leq 5.5\text{ V}@1\text{ MHz}$ to $24\text{ MHz}$ $2.4\text{ V} \leq V_{DD} \leq 5.5\text{ V}@1\text{ MHz}$ to $16\text{ MHz}$
High-speed on-chip oscillator clock accuracy	$1.8\text{ V} \leq V_{DD} \leq 5.5\text{ V}$ : $\pm 1.0\%$ @ $T_A = -20$ to $+85^\circ\text{C}$ $\pm 1.5\%$ @ $T_A = -40$ to $-20^\circ\text{C}$ $1.6\text{ V} \leq V_{DD} < 1.8\text{ V}$ : $\pm 5.0\%$ @ $T_A = -20$ to $+85^\circ\text{C}$ $\pm 5.5\%$ @ $T_A = -40$ to $-20^\circ\text{C}$	$2.4\text{ V} \leq V_{DD} \leq 5.5\text{ V}$ : $\pm 2.0\%$ @ $T_A = +85$ to $+105^\circ\text{C}$ $\pm 1.0\%$ @ $T_A = -20$ to $+85^\circ\text{C}$ $\pm 1.5\%$ @ $T_A = -40$ to $-20^\circ\text{C}$
Serial array unit	UART CSI: $f_{CLK}/2$ (16 Mbps supported), $f_{CLK}/4$ Simplified I <sup>2</sup> C	UART CSI: $f_{CLK}/4$ Simplified I <sup>2</sup> C
IICA	Standard mode Fast mode Fast mode plus	Standard mode Fase mode
Voltage detector	<ul style="list-style-type: none"> <li>Rising: 1.67 V to 4.06 V (14 levels)</li> <li>Falling: 1.63 V to 3.98 V (14 levels)</li> </ul>	<ul style="list-style-type: none"> <li>Rising: 2.61 V to 4.06 V (8 levels)</li> <li>Falling: 2.55 V to 3.98 V (8 levels)</li> </ul>

**Remark** Electrical specifications of G: Industrial applications ( $T_A = -40$  to  $+105^\circ\text{C}$ ) differ from “A: Consumer applications”. For details, see 3.1 to 3.11 below.

### 3.1 Absolute Maximum Ratings

#### Absolute Maximum Ratings (1/3)

Parameter	Symbol	Conditions	Ratings	Unit
Supply voltage	$V_{DD}$		-0.5 to +6.5	V
REGC pin input voltage	$V_{IREGC}$	REGC	-0.3 to +2.8 and -0.3 to $V_{DD} + 0.3$ <sup>Note 1</sup>	V
Input voltage	$V_{I1}$	P00 to P07, P10 to P17, P20 to P27, P30 to P35, P40 to P47, P50 to P57, P60, P61, P70 to P77, P121 to P127, P130, P137	-0.3 to $V_{DD} + 0.3$ <sup>Note 2</sup>	V
	$V_{I2}$	P60 and P61 (N-ch open-drain)	-0.3 to +6.5	V
	$V_{I3}$	EXCLK, EXCLKS, $\overline{\text{RESET}}$	-0.3 to $V_{DD} + 0.3$ <sup>Note 2</sup>	V
Output voltage	$V_{O1}$	P00 to P07, P10 to P17, P20 to P27, P30 to P35, P40 to P47, P50 to P57, P60, P61, P70 to P77, P121 to P127, P130, P137	-0.3 to $V_{DD} + 0.3$ <sup>Note 2</sup>	V
Analog input voltage	$V_{AI1}$	ANI0, ANI1, ANI16 to ANI26	-0.3 to $V_{DD} + 0.3$ and -0.3 to $AV_{REF(+)} + 0.3$ <sup>Notes 2, 3</sup>	V

**Notes 1.** Connect the REGC pin to  $V_{SS}$  via a capacitor (0.47 to 1  $\mu\text{F}$ ). This value regulates the absolute maximum rating of the REGC pin. Do not use this pin with voltage applied to it.

**2.** Must be 6.5 V or lower.

**3.** Do not exceed  $AV_{REF(+)} + 0.3$  V in case of A/D conversion target pin.

**Caution** Product quality may suffer if the absolute maximum rating is exceeded even momentarily for any parameter. That is, the absolute maximum ratings are rated values at which the product is on the verge of suffering physical damage, and therefore the product must be used under conditions that ensure that the absolute maximum ratings are not exceeded.

**Remarks 1.** Unless specified otherwise, the characteristics of alternate-function pins are the same as those of the port pins.

**2.**  $AV_{REF(+)}$ : + side reference voltage of the A/D converter.

**3.**  $V_{SS}$ : Reference voltage



**Absolute Maximum Ratings (2/3)**

Parameter	Symbol	Conditions	Ratings	Unit
LCD voltage	$V_{L1}$	$V_{L1}$ voltage <sup>Note 1</sup>	-0.3 to +2.8 and -0.3 to $V_{L4} + 0.3$	V
	$V_{L2}$	$V_{L2}$ voltage <sup>Note 1</sup>	-0.3 to $V_{L4} + 0.3$ <sup>Note 2</sup>	V
	$V_{L3}$	$V_{L3}$ voltage <sup>Note 1</sup>	-0.3 to $V_{L4} + 0.3$ <sup>Note 2</sup>	V
	$V_{L4}$	$V_{L4}$ voltage <sup>Note 1</sup>	-0.3 to +6.5	V
	$V_{LCAP}$	CAPL, CAPH voltage <sup>Note 1</sup>	-0.3 to $V_{L4} + 0.3$ <sup>Note 2</sup>	V
	$V_{OUT}$	COM0 to COM7 SEG0 to SEG50 output voltage	External resistance division method	-0.3 to $V_{DD} + 0.3$ <sup>Note 2</sup>
		Capacitor split method	-0.3 to $V_{DD} + 0.3$ <sup>Note 2</sup>	V
		Internal voltage boosting method	-0.3 to $V_{L4} + 0.3$ <sup>Note 2</sup>	V

**Notes 1.** This value only indicates the absolute maximum ratings when applying voltage to the  $V_{L1}$ ,  $V_{L2}$ ,  $V_{L3}$ , and  $V_{L4}$  pins; it does not mean that applying voltage to these pins is recommended. When using the internal voltage boosting method or capacitance split method, connect these pins to  $V_{SS}$  via a capacitor ( $0.47 \mu\text{F} \pm 30\%$ ) and connect a capacitor ( $0.47 \mu\text{F} \pm 30\%$ ) between the CAPL and CAPH pins.

**2.** Must be 6.5 V or lower.

**Caution** Product quality may suffer if the absolute maximum rating is exceeded even momentarily for any parameter. That is, the absolute maximum ratings are rated values at which the product is on the verge of suffering physical damage, and therefore the product must be used under conditions that ensure that the absolute maximum ratings are not exceeded.

**Remark**  $V_{SS}$ : Reference voltage

**Absolute Maximum Ratings ( $T_A = 25^\circ\text{C}$ ) (3/3)**

Parameter	Symbol	Conditions		Ratings	Unit
<R> Output current, high	$I_{OH1}$	Per pin	P00 to P07, P10 to P17, P22 to P27, P30 to P35, P40 to P47, P50 to P57, P60, P61, P70 to P77, P125 to P127, P130	-40	mA
<R>		Total of all pins -170 mA	P00 to P07, P10 to P17, P22 to P27, P30 to P35, P40 to P47, P50 to P57, P60, P61, P70 to P77, P125 to P127, P130	-170	mA
<R>	$I_{OH2}$	Per pin	P20, P21	-0.5	mA
<R>		Total of all pins		-1	mA
<R> Output current, low	$I_{OL1}$	Per pin	P00 to P07, P10 to P17, P22 to P27, P30 to P35, P40 to P47, P50 to P57, P60, P61, P70 to P77, P125 to P127, P130	40	mA
<R>		Total of all pins 170 mA	P40 to P47, P130	70	mA
<R>	$I_{OL2}$	Per pin	P00 to P07, P10 to P17, P22 to P27, P30 to P35, P50 to P57, P60, P61, P70 to P77, P125 to P127	100	mA
<R>		Total of all pins		2	mA
Operating ambient temperature	$T_A$	In normal operation mode		-40 to +105	$^\circ\text{C}$
		In flash memory programming mode			$^\circ\text{C}$
Storage temperature	$T_{stg}$			-65 to +150	$^\circ\text{C}$

**Caution** Product quality may suffer if the absolute maximum rating is exceeded even momentarily for any parameter. That is, the absolute maximum ratings are rated values at which the product is on the verge of suffering physical damage, and therefore the product must be used under conditions that ensure that the absolute maximum ratings are not exceeded.

**Remark** Unless specified otherwise, the characteristics of alternate-function pins are the same as those of the port pins.

### 3.2 Oscillator Characteristics

#### 3.2.1 X1 and XT1 oscillator characteristics

( $T_A = -40$  to  $+105^\circ\text{C}$ ,  $2.4\text{ V} \leq V_{DD} \leq 5.5\text{ V}$ ,  $V_{SS} = 0\text{ V}$ )

Parameter	Resonator	Conditions	MIN.	TYP.	MAX.	Unit
X1 clock oscillation frequency ( $f_X$ ) <sup>Note</sup>	Ceramic resonator/ crystal resonator	$2.7\text{ V} \leq V_{DD} \leq 5.5\text{ V}$	1.0		20.0	MHz
		$2.4\text{ V} \leq V_{DD} < 2.7\text{ V}$	1.0		16.0	
XT1 clock oscillation frequency ( $f_{XT}$ ) <sup>Note</sup>	Crystal resonator		32	32.768	35	kHz

**Note** Indicates only permissible oscillator frequency ranges. Refer to **AC Characteristics** for instruction execution time. Request evaluation by the manufacturer of the oscillator circuit mounted on a board to check the oscillator characteristics.

**Caution** Since the CPU is started by the high-speed on-chip oscillator clock after a reset release, check the X1 clock oscillation stabilization time using the oscillation stabilization time counter status register (OSTC) by the user. Determine the oscillation stabilization time of the OSTC register and the oscillation stabilization time select register (OSTS) after sufficiently evaluating the oscillation stabilization time with the resonator to be used.

**Remark** When using the X1 oscillator and XT1 oscillator, see 5.4 **System Clock Oscillator** in the RL78/L13 User's Manual.

#### 3.2.2 On-chip oscillator characteristics

( $T_A = -40$  to  $+105^\circ\text{C}$ ,  $2.4\text{ V} \leq V_{DD} \leq 5.5\text{ V}$ ,  $V_{SS} = 0\text{ V}$ )

Parameter	Symbol	Conditions		MIN.	TYP.	MAX.	Unit
High-speed on-chip oscillator clock frequency <sup>Notes 1, 2</sup>	$f_{IH}$			1		24	MHz
High-speed on-chip oscillator clock frequency accuracy		+85 to $+105^\circ\text{C}$	$2.4\text{ V} \leq V_{DD} \leq 5.5\text{ V}$	-2		+2	%
		-20 to $+85^\circ\text{C}$	$2.4\text{ V} \leq V_{DD} \leq 5.5\text{ V}$	-1		+1	%
		-40 to $-20^\circ\text{C}$	$2.4\text{ V} \leq V_{DD} \leq 5.5\text{ V}$	-1.5		+1.5	%
Low-speed on-chip oscillator clock frequency	$f_{IL}$				15		kHz
Low-speed on-chip oscillator clock frequency accuracy				-15		+15	%

**Notes 1.** The high-speed on-chip oscillator frequency is selected by bits 0 to 4 of the option byte (000C2H/010C2H) and bits 0 to 2 of the HOCODIV register.

**2.** This indicates the oscillator characteristics only. Refer to **AC Characteristics** for the instruction execution time.

## 3.3 DC Characteristics

## 3.3.1 Pin characteristics

**( $T_A = -40$  to  $+105^\circ\text{C}$ ,  $2.4\text{ V} \leq V_{DD} \leq 5.5\text{ V}$ ,  $V_{SS} = 0\text{ V}$ )**

Parameter	Symbol	Conditions	MIN.	TYP.	MAX.	Unit	
Output current, high <sup>Note 1</sup>	I <sub>OH1</sub>	Per pin for P00 to P07, P10 to P17, P22 to P27, P30 to P35, P40 to P47, P50 to P57, P70 to P77, P125 to P127, P130	$2.4\text{ V} \leq V_{DD} \leq 5.5\text{ V}$			-3.0 <sup>Note 2</sup>	mA
		Total of P00 to P07, P10 to P17, P22 to P27, P30 to P35, P40 to P47, P50 to P57, P70 to P77, P125 to P127, P130 (When duty = 70% <sup>Note 3</sup> )	$4.0\text{ V} \leq V_{DD} \leq 5.5\text{ V}$			-45.0	mA
			$2.7\text{ V} \leq V_{DD} < 4.0\text{ V}$			-15.0	mA
			$2.4\text{ V} \leq V_{DD} < 2.7\text{ V}$			-7.0	mA
	I <sub>OH2</sub>	Per pin for P20 and P21	$2.4\text{ V} \leq V_{DD} \leq 5.5\text{ V}$			-0.1 <sup>Note 2</sup>	mA
		Total of all pins (When duty = 70% <sup>Note 3</sup> )	$2.4\text{ V} \leq V_{DD} \leq 5.5\text{ V}$			-0.2	mA

**Notes** 1. Value of the current at which the device operation is guaranteed even if the current flows from the  $V_{DD}$  pin to an output pin

2. Do not exceed the total current value.

3. Output current value under conditions where the duty factor  $\leq 70\%$ .

The output current value that has changed to the duty factor  $> 70\%$  the duty ratio can be calculated with the following expression (when changing the duty factor from 70% to n%).

- Total output current of pins =  $(I_{OH} \times 0.7)/(n \times 0.01)$

<Example> Where  $n = 80\%$  and  $I_{OH} = -45.0\text{ mA}$

$$\text{Total output current of pins} = (-45.0 \times 0.7)/(80 \times 0.01) = -39.375\text{ mA}$$

However, the current that is allowed to flow into one pin does not vary depending on the duty factor. A current higher than the absolute maximum rating must not flow into one pin.

**Caution** P00, P04 to P07, P16, P17, P35, P42 to P44, P46, P47, P53 to P56, and P130 do not output high level in N-ch open-drain mode.

**Remark** Unless specified otherwise, the characteristics of alternate-function pins are the same as those of the port pins.

**( $T_A = -40$  to  $+105^\circ\text{C}$ ,  $2.4\text{ V} \leq V_{DD} \leq 5.5\text{ V}$ ,  $V_{SS} = 0\text{ V}$ )**

Parameter	Symbol	Conditions	MIN.	TYP.	MAX.	Unit
Output current, $I_{OL}$ <sup>Note 1</sup>	$I_{OL1}$	Per pin for P00 to P07, P10 to P17, P22 to P27, P30 to P35, P40 to P47, P50 to P57, P70 to P77, P125 to P127, P130			8.5 <sup>Note 2</sup>	mA
		Per pin for P60 and P61			15.0 <sup>Note 2</sup>	mA
		Total of P40 to P47, P130 (When duty = 70% <sup>Note 3</sup> )	$4.0\text{ V} \leq V_{DD} \leq 5.5\text{ V}$		40.0	mA
			$2.7\text{ V} \leq V_{DD} < 4.0\text{ V}$		15.0	mA
			$2.4\text{ V} \leq V_{DD} < 2.7\text{ V}$		9.0	mA
		Total of P00 to P07, P10 to P17, P22 to P27, P30 to P35, P50 to P57, P70 to P77, P125 to P127 (When duty = 70% <sup>Note 3</sup> )	$4.0\text{ V} \leq V_{DD} \leq 5.5\text{ V}$		60.0	mA
			$2.7\text{ V} \leq V_{DD} < 4.0\text{ V}$		35.0	mA
	$2.4\text{ V} \leq V_{DD} < 2.7\text{ V}$			20.0	mA	
	Total of all pins (When duty = 70% <sup>Note 3</sup> )			100.0	mA	
	$I_{OL2}$	Per pin for P20 and P21			0.4 <sup>Note 2</sup>	mA
Total of all pins (When duty = 70% <sup>Note 3</sup> )		$2.4\text{ V} \leq V_{DD} \leq 5.5\text{ V}$		0.8	mA	

**Notes** 1. Value of the current at which the device operation is guaranteed even if the current flows from an output pin to the  $V_{SS}$  pin

2. Do not exceed the total current value.

3. Output current value under conditions where the duty factor  $\leq 70\%$ .

The output current value that has changed to the duty factor  $> 70\%$  the duty ratio can be calculated with the following expression (when changing the duty factor from 70% to  $n\%$ ).

- Total output current of pins =  $(I_{OL} \times 0.7)/(n \times 0.01)$

<Example> Where  $n = 80\%$  and  $I_{OL} = 40.0\text{ mA}$

$$\text{Total output current of pins} = (40.0 \times 0.7)/(80 \times 0.01) = 35.0\text{ mA}$$

However, the current that is allowed to flow into one pin does not vary depending on the duty factor. A current higher than the absolute maximum rating must not flow into one pin.

**Remark** Unless specified otherwise, the characteristics of alternate-function pins are the same as those of the port pins.

**( $T_A = -40$  to  $+105^\circ\text{C}$ ,  $2.4\text{ V} \leq V_{DD} \leq 5.5\text{ V}$ ,  $V_{SS} = 0\text{ V}$ )**

Parameter	Symbol	Conditions	MIN.	TYP.	MAX.	Unit	
Input voltage, high	$V_{IH1}$	P00 to P07, P10 to P17, P22 to P27, P30 to P35, P40 to P47, P50 to P57, P70 to P77, P125 to P127, P130, P137	Normal input buffer	$0.8V_{DD}$		$V_{DD}$	V
	$V_{IH2}$	P03, P05, P06, P16, P17, P34, P43, P44, P46, P47, P53, P55	TTL input buffer $4.0\text{ V} \leq V_{DD} \leq 5.5\text{ V}$	2.2		$V_{DD}$	V
			TTL input buffer $3.3\text{ V} \leq V_{DD} < 4.0\text{ V}$	2.0		$V_{DD}$	V
			TTL input buffer $2.4\text{ V} \leq V_{DD} < 3.3\text{ V}$	1.5		$V_{DD}$	V
	$V_{IH3}$	P20, P21		$0.7V_{DD}$		$V_{DD}$	V
	$V_{IH4}$	P60, P61		$0.7V_{DD}$		6.0	V
	$V_{IH5}$	P121 to P124, P137, EXCLK, EXCLKS, RESET		$0.8V_{DD}$		$V_{DD}$	V
Input voltage, low	$V_{IL1}$	P00 to P07, P10 to P17, P22 to P27, P30 to P35, P40 to P47, P50 to P57, P70 to P77, P125 to P127, P130, P137	Normal input buffer	0		$0.2V_{DD}$	V
	$V_{IL2}$	P03, P05, P06, P16, P17, P34, P43, P44, P46, P47, P53, P55	TTL input buffer $4.0\text{ V} \leq V_{DD} \leq 5.5\text{ V}$	0		0.8	V
			TTL input buffer $3.3\text{ V} \leq V_{DD} < 4.0\text{ V}$	0		0.5	V
			TTL input buffer $2.4\text{ V} \leq V_{DD} < 3.3\text{ V}$	0		0.32	V
	$V_{IL3}$	P20, P21		0		$0.3V_{DD}$	V
	$V_{IL4}$	P60, P61		0		$0.3V_{DD}$	V
	$V_{IL5}$	P121 to P124, P137, EXCLK, EXCLKS, RESET		0		$0.2V_{DD}$	V

**Caution** The maximum value of  $V_{IH}$  of pins P00, P04 to P07, P16, P17, P35, P42 to P44, P46, P47, P53 to P56, and P130 is  $V_{DD}$ , even in the N-ch open-drain mode.

**Remark** Unless specified otherwise, the characteristics of alternate-function pins are the same as those of the port pins.

**( $T_A = -40$  to  $+105^\circ\text{C}$ ,  $2.4\text{ V} \leq V_{DD} \leq 5.5\text{ V}$ ,  $V_{SS} = 0\text{ V}$ )**

Parameter	Symbol	Conditions	MIN.	TYP.	MAX.	Unit
Output voltage, high	V <sub>OH1</sub>	P00 to P07, P10 to P17, P22 to P27, P30 to P35, P40 to P47, P50 to P57, P70 to P77, P125 to P127, P130	$4.0\text{ V} \leq V_{DD} \leq 5.5\text{ V}$ , $I_{OH1} = -3.0\text{ mA}$			V
			$2.7\text{ V} \leq V_{DD} \leq 5.5\text{ V}$ , $I_{OH1} = -2.0\text{ mA}$			V
			$2.4\text{ V} \leq V_{DD} \leq 5.5\text{ V}$ , $I_{OH1} = -1.5\text{ mA}$			V
	V <sub>OH2</sub>	P20 and P21	$2.4\text{ V} \leq V_{DD} \leq 5.5\text{ V}$ , $I_{OH2} = -100\ \mu\text{A}$			V
Output voltage, low	V <sub>OL1</sub>	P00 to P07, P10 to P17, P22 to P27, P30 to P35, P40 to P47, P50 to P57, P70 to P77, P125 to P127, P130	$4.0\text{ V} \leq V_{DD} \leq 5.5\text{ V}$ , $I_{OL1} = 8.5\text{ mA}$		0.7	V
			$2.7\text{ V} \leq V_{DD} \leq 5.5\text{ V}$ , $I_{OL1} = 3.0\text{ mA}$		0.6	V
			$2.7\text{ V} \leq V_{DD} \leq 5.5\text{ V}$ , $I_{OL1} = 1.5\text{ mA}$		0.4	V
			$2.4\text{ V} \leq V_{DD} \leq 5.5\text{ V}$ , $I_{OL1} = 0.6\text{ mA}$		0.4	V
	V <sub>OL2</sub>	P20 and P21	$2.4\text{ V} \leq V_{DD} \leq 5.5\text{ V}$ , $I_{OL2} = 400\ \mu\text{A}$		0.4	V
	V <sub>OL3</sub>	P60 and P61	$4.0\text{ V} \leq V_{DD} \leq 5.5\text{ V}$ , $I_{OL3} = 15.0\text{ mA}$		2.0	V
			$4.0\text{ V} \leq V_{DD} \leq 5.5\text{ V}$ , $I_{OL3} = 5.0\text{ mA}$		0.4	V
			$2.7\text{ V} \leq V_{DD} \leq 5.5\text{ V}$ , $I_{OL3} = 3.0\text{ mA}$		0.4	V
$2.4\text{ V} \leq V_{DD} \leq 5.5\text{ V}$ , $I_{OL3} = 2.0\text{ mA}$				0.4	V	

**Caution** P00, P04 to P07, P16, P17, P35, P42 to P44, P46, P47, P53 to P56, and P130 do not output high level in N-ch open-drain mode.

**Remark** Unless specified otherwise, the characteristics of alternate-function pins are the same as those of the port pins.

**( $T_A = -40$  to  $+105^\circ\text{C}$ ,  $2.4\text{ V} \leq V_{DD} \leq 5.5\text{ V}$ ,  $V_{SS} = 0\text{ V}$ )**

Parameter	Symbol	Conditions	MIN.	TYP.	MAX.	Unit		
Input leakage current, high	I <sub>LIH1</sub>	P00 to P07, P10 to P17, P22 to P27, P30 to P35, P40 to P47, P50 to P57, P70 to P77, P125 to P127, P130, P137	V <sub>I</sub> = V <sub>DD</sub>		1	μA		
	I <sub>LIH2</sub>	P20 and P21, $\overline{\text{RESET}}$	V <sub>I</sub> = V <sub>DD</sub>		1	μA		
	I <sub>LIH3</sub>	P121 to P124 (X1, X2, XT1, XT2, EXCLK, EXCLKS)	V <sub>I</sub> = V <sub>DD</sub>	In input port mode and when external clock is input		1	μA	
				Resonator connected		10	μA	
Input leakage current, low	I <sub>LIL1</sub>	P00 to P07, P10 to P17, P22 to P27, P30 to P35, P40 to P47, P50 to P57, P70 to P77, P125 to P127, P130, P137	V <sub>I</sub> = V <sub>SS</sub>		-1	μA		
	I <sub>LIL2</sub>	P20 and P21, $\overline{\text{RESET}}$	V <sub>I</sub> = V <sub>SS</sub>		-1	μA		
	I <sub>LIL3</sub>	P121 to P124 (X1, X2, XT1, XT2, EXCLK, EXCLKS)	V <sub>I</sub> = V <sub>SS</sub>	In input port mode and when external clock is input		-1	μA	
				Resonator connected		-10	μA	
On-chip pull-up resistance	R <sub>U1</sub>	P00 to P07, P10 to P17, P22 to P27, P30 to P35, P45 to P47, P50 to P57, P70 to P77, P125 to P127, P130	V <sub>I</sub> = V <sub>SS</sub>		10	20	100	kΩ
	R <sub>U2</sub>	P40 to P44	V <sub>I</sub> = V <sub>SS</sub>		10	20	100	kΩ

**Remark** Unless specified otherwise, the characteristics of alternate-function pins are the same as those of the port pins.



3.3.2 Supply current characteristics

(T<sub>A</sub> = -40 to +105°C, 2.4 V ≤ V<sub>DD</sub> ≤ 5.5 V, V<sub>SS</sub> = 0 V)

(1/2)

Parameter	Symbol	Conditions				MIN.	TYP.	MAX.	Unit	
Supply current	I <sub>DD1</sub> <sup>Note 1</sup>	Operating mode	HS (high-speed main) mode <sup>Note 5</sup>	f <sub>HOCC</sub> = 48 MHz <sup>Note 3</sup> , f <sub>IH</sub> = 24 MHz <sup>Note 3</sup>	Basic operation	V <sub>DD</sub> = 5.0 V		2.0		mA
						V <sub>DD</sub> = 3.0 V		2.0		mA
					Normal operation	V <sub>DD</sub> = 5.0 V		3.8	7.0	mA
				V <sub>DD</sub> = 3.0 V			3.8	7.0	mA	
				f <sub>HOCC</sub> = 24 MHz <sup>Note 3</sup> , f <sub>IH</sub> = 24 MHz <sup>Note 3</sup>	Basic operation	V <sub>DD</sub> = 5.0 V		1.7		mA
						V <sub>DD</sub> = 3.0 V		1.7		mA
			Normal operation		V <sub>DD</sub> = 5.0 V		3.6	6.5	mA	
				V <sub>DD</sub> = 3.0 V		3.6	6.5	mA		
			f <sub>HOCC</sub> = 16 MHz <sup>Note 3</sup> , f <sub>IH</sub> = 16 MHz <sup>Note 3</sup>	Normal operation	V <sub>DD</sub> = 5.0 V		2.7	5.0	mA	
					V <sub>DD</sub> = 3.0 V		2.7	5.0	mA	
			HS (high-speed main) mode <sup>Note 5</sup>	f <sub>MX</sub> = 20 MHz <sup>Note 2</sup> , V <sub>DD</sub> = 5.0 V	Normal operation	Square wave input		3.0	5.4	mA
						Resonator connection		3.2	5.6	mA
		f <sub>MX</sub> = 20 MHz <sup>Note 2</sup> , V <sub>DD</sub> = 3.0 V		Normal operation	Square wave input		2.9	5.4	mA	
					Resonator connection		3.2	5.6	mA	
		f <sub>MX</sub> = 10 MHz <sup>Note 2</sup> , V <sub>DD</sub> = 5.0 V		Normal operation	Square wave input		1.9	3.2	mA	
					Resonator connection		1.9	3.2	mA	
		f <sub>MX</sub> = 10 MHz <sup>Note 2</sup> , V <sub>DD</sub> = 3.0 V		Normal operation	Square wave input		1.9	3.2	mA	
					Resonator connection		1.9	3.2	mA	
		Subsystem clock operation	f <sub>SUB</sub> = 32.768 kHz <sup>Note 4</sup> , T <sub>A</sub> = -40°C	Normal operation	Square wave input		4.0	5.4	μA	
					Resonator connection		4.3	5.4	μA	
			f <sub>SUB</sub> = 32.768 kHz <sup>Note 4</sup> , T <sub>A</sub> = +25°C	Normal operation	Square wave input		4.0	5.4	μA	
					Resonator connection		4.3	5.4	μA	
			f <sub>SUB</sub> = 32.768 kHz <sup>Note 4</sup> , T <sub>A</sub> = +50°C	Normal operation	Square wave input		4.1	7.1	μA	
					Resonator connection		4.4	7.1	μA	
f <sub>SUB</sub> = 32.768 kHz <sup>Note 4</sup> , T <sub>A</sub> = +70°C	Normal operation		Square wave input		4.3	8.7	μA			
			Resonator connection		4.7	8.7	μA			
f <sub>SUB</sub> = 32.768 kHz <sup>Note 4</sup> , T <sub>A</sub> = +85°C	Normal operation		Square wave input		4.7	12.0	μA			
			Resonator connection		5.2	12.0	μA			
f <sub>SUB</sub> = 32.768 kHz <sup>Note 4</sup> , T <sub>A</sub> = +105°C	Normal operation		Square wave input		6.4	35.0	μA			
			Resonator connection		6.6	35.0	μA			

(Notes and Remarks are listed on the next page.)

- Notes**
1. Total current flowing into  $V_{DD}$ , including the input leakage current flowing when the level of the input pin is fixed to  $V_{DD}$  or  $V_{SS}$ . The values below the MAX. column include the peripheral operation current. However, not including the current flowing into the LCD controller/driver, A/D converter, LVD circuit, comparator, I/O port, on-chip pull-up/pull-down resistors, and the current flowing during data flash rewrite.
  2. When high-speed on-chip oscillator and subsystem clock are stopped.
  3. When high-speed system clock and subsystem clock are stopped.
  4. When high-speed on-chip oscillator and high-speed system clock are stopped. When setting ultra-low power consumption oscillation ( $AMPHS1 = 1$ ). The current flowing into the LCD controller/driver, 16-bit timer KB20, real-time clock 2, 12-bit interval timer, and watchdog timer is not included.
  5. Relationship between operation voltage width, operation frequency of CPU and operation mode is as below.  
HS (high-speed main) mode:  $2.7\text{ V} \leq V_{DD} \leq 5.5\text{ V}@1\text{ MHz to }24\text{ MHz}$   
 $2.4\text{ V} \leq V_{DD} \leq 5.5\text{ V}@1\text{ MHz to }16\text{ MHz}$

- Remarks**
1.  $f_{MX}$ : High-speed system clock frequency (X1 clock oscillation frequency or external main system clock frequency)
  2.  $f_{HOCO}$ : High-speed on-chip oscillator clock frequency (48 MHz max.)
  3.  $f_{IH}$ : High-speed on-chip oscillator clock frequency (24 MHz max.)
  4.  $f_{SUB}$ : Subsystem clock frequency (XT1 clock oscillation frequency)
  5. Except subsystem clock operation, temperature condition of the TYP. value is  $T_A = 25^\circ\text{C}$

$(T_A = -40$  to  $+105^\circ\text{C}$ ,  $2.4\text{ V} \leq V_{DD} \leq 5.5\text{ V}$ ,  $V_{SS} = 0\text{ V}$ )

(2/2)

Parameter	Symbol	Conditions			MIN.	TYP.	MAX.	Unit	
Supply current Note 1	$I_{DD2}$ Note 2	HALT mode	HS (high-speed main) mode Note 7	$f_{HOCO} = 48\text{ MHz}$ Note 4, $f_{IH} = 24\text{ MHz}$ Note 4	$V_{DD} = 5.0\text{ V}$		0.71	2.55	mA
					$V_{DD} = 3.0\text{ V}$		0.71	2.55	mA
				$f_{HOCO} = 24\text{ MHz}$ Note 4, $f_{IH} = 24\text{ MHz}$ Note 4	$V_{DD} = 5.0\text{ V}$		0.49	1.95	mA
					$V_{DD} = 3.0\text{ V}$		0.49	1.95	mA
			$f_{HOCO} = 16\text{ MHz}$ Note 4, $f_{IH} = 16\text{ MHz}$ Note 4	$V_{DD} = 5.0\text{ V}$		0.43	1.50	mA	
				$V_{DD} = 3.0\text{ V}$		0.43	1.50	mA	
			HS (high-speed main) mode Note 7	$f_{MX} = 20\text{ MHz}$ Note 3, $V_{DD} = 5.0\text{ V}$	Square wave input		0.31	1.76	mA
					Resonator connection		0.48	1.92	mA
		$f_{MX} = 20\text{ MHz}$ Note 3, $V_{DD} = 3.0\text{ V}$		Square wave input		0.29	1.76	mA	
				Resonator connection		0.48	1.92	mA	
		$f_{MX} = 10\text{ MHz}$ Note 3, $V_{DD} = 5.0\text{ V}$	Square wave input		0.20	0.96	mA		
			Resonator connection		0.28	1.07	mA		
		$f_{MX} = 10\text{ MHz}$ Note 3, $V_{DD} = 3.0\text{ V}$	Square wave input		0.19	0.96	mA		
			Resonator connection		0.28	1.07	mA		
	Subsystem clock operation	$f_{SUB} = 32.768\text{ kHz}$ Note 5, $T_A = -40^\circ\text{C}$	Square wave input		0.34	0.62	$\mu\text{A}$		
			Resonator connection		0.51	0.80	$\mu\text{A}$		
		$f_{SUB} = 32.768\text{ kHz}$ Note 5, $T_A = +25^\circ\text{C}$	Square wave input		0.38	0.62	$\mu\text{A}$		
			Resonator connection		0.57	0.80	$\mu\text{A}$		
		$f_{SUB} = 32.768\text{ kHz}$ Note 5, $T_A = +50^\circ\text{C}$	Square wave input		0.46	2.30	$\mu\text{A}$		
			Resonator connection		0.67	2.49	$\mu\text{A}$		
$f_{SUB} = 32.768\text{ kHz}$ Note 5, $T_A = +70^\circ\text{C}$		Square wave input		0.65	4.03	$\mu\text{A}$			
		Resonator connection		0.91	4.22	$\mu\text{A}$			
$f_{SUB} = 32.768\text{ kHz}$ Note 5, $T_A = +85^\circ\text{C}$	Square wave input		1.00	8.04	$\mu\text{A}$				
	Resonator connection		1.31	8.23	$\mu\text{A}$				
$f_{SUB} = 32.768\text{ kHz}$ Note 5, $T_A = +105^\circ\text{C}$	Square wave input		3.05	27.00	$\mu\text{A}$				
	Resonator connection		3.24	27.00	$\mu\text{A}$				
$I_{DD3}$ Note 6	STOP mode Note 8	$T_A = -40^\circ\text{C}$				0.18	0.52	$\mu\text{A}$	
		$T_A = +25^\circ\text{C}$				0.24	0.52	$\mu\text{A}$	
		$T_A = +50^\circ\text{C}$				0.33	2.21	$\mu\text{A}$	
		$T_A = +70^\circ\text{C}$				0.53	3.94	$\mu\text{A}$	
		$T_A = +85^\circ\text{C}$				0.93	7.95	$\mu\text{A}$	
		$T_A = +105^\circ\text{C}$				2.91	25.00	$\mu\text{A}$	

(Notes and Remarks are listed on the next page.)

- Notes**
1. Total current flowing into  $V_{DD}$ , including the input leakage current flowing when the level of the input pin is fixed to  $V_{DD}$  or  $V_{SS}$ . The values below the MAX. column include the peripheral operation current. However, not including the current flowing into the LCD controller/driver, A/D converter, LVD circuit, comparator, I/O port, on-chip pull-up/pull-down resistors, and the current flowing during data flash rewrite.
  2. During HALT instruction execution by flash memory.
  3. When high-speed on-chip oscillator and subsystem clock are stopped.
  4. When high-speed system clock and subsystem clock are stopped.
  5. When high-speed on-chip oscillator and high-speed system clock are stopped.  
When  $RTCLPC = 1$  and setting ultra-low current consumption ( $AMPHS1 = 1$ ). The current flowing into the real-time clock 2 is included. The current flowing into the clock output/buzzer output, 12-bit interval timer, and watchdog timer is not included.
  6. The current flowing into the real-time clock 2, clock output/buzzer output, 12-bit interval timer, and watchdog timer is not included.
  7. Relationship between operation voltage width, operation frequency of CPU and operation mode is as below.  
HS (high-speed main) mode:  $2.7\text{ V} \leq V_{DD} \leq 5.5\text{ V}@1\text{ MHz to }24\text{ MHz}$   
 $2.4\text{ V} \leq V_{DD} \leq 5.5\text{ V}@1\text{ MHz to }16\text{ MHz}$
  8. Regarding the value for current to operate the subsystem clock in STOP mode, refer to that in HALT mode.

- Remarks**
1.  $f_{MX}$ : High-speed system clock frequency (X1 clock oscillation frequency or external main system clock frequency)
  2.  $f_{HOCO}$ : High-speed on-chip oscillator clock frequency (48 MHz max.)
  3.  $f_{IH}$ : High-speed on-chip oscillator clock frequency (24 MHz max.)
  4.  $f_{SUB}$ : Subsystem clock frequency (XT1 clock oscillation frequency)
  5. Except subsystem clock operation and STOP mode, temperature condition of the TYP. value is  $T_A = 25^\circ\text{C}$

**( $T_A = -40$  to  $+105^\circ\text{C}$ ,  $2.4\text{ V} \leq V_{DD} \leq 5.5\text{ V}$ ,  $V_{SS} = 0\text{ V}$ )**

Parameter	Symbol	Conditions			MIN.	TYP.	MAX.	Unit	
Low-speed on-chip oscillator operating current	$I_{FIL}$ <sup>Note 1</sup>					0.20		$\mu\text{A}$	
RTC2 operating current	$I_{RTC}$ <sup>Notes 1, 2, 3</sup>	$f_{SUB} = 32.768\text{ kHz}$				0.02		$\mu\text{A}$	
12-bit interval timer operating current	$I_{TMKA}$ <sup>Notes 1, 2, 4</sup>					0.04		$\mu\text{A}$	
Watchdog timer operating current	$I_{WDT}$ <sup>Notes 1, 2, 5</sup>	$f_{IL} = 15\text{ kHz}$				0.22		$\mu\text{A}$	
A/D converter operating current	$I_{ADC}$ <sup>Notes 1, 6</sup>	When conversion at maximum speed	Normal mode, $AV_{REFP} = V_{DD} = 5.0\text{ V}$			1.3	1.7	$\text{mA}$	
			Low voltage mode, $AV_{REFP} = V_{DD} = 3.0\text{ V}$			0.5	0.7	$\text{mA}$	
A/D converter reference voltage current	$I_{ADREF}$ <sup>Note 1</sup>					75.0		$\mu\text{A}$	
Temperature sensor operating current	$I_{TMPS}$ <sup>Note 1</sup>					75.0		$\mu\text{A}$	
LVD operating current	$I_{LVD}$ <sup>Notes 1, 7</sup>					0.08		$\mu\text{A}$	
Comparator operating current	$I_{CMP}$ <sup>Notes 1, 11</sup>	$V_{DD} = 5.0\text{ V}$ , Regulator output voltage = $2.1\text{ V}$	Window mode			12.5		$\mu\text{A}$	
			Comparator high-speed mode			6.5		$\mu\text{A}$	
			Comparator low-speed mode			1.7		$\mu\text{A}$	
		$V_{DD} = 5.0\text{ V}$ , Regulator output voltage = $1.8\text{ V}$	Window mode			8.0		$\mu\text{A}$	
			Comparator high-speed mode			4.0		$\mu\text{A}$	
			Comparator low-speed mode			1.3		$\mu\text{A}$	
Self-programming operating current	$I_{FSP}$ <sup>Notes 1, 9</sup>					2.00	12.20	$\text{mA}$	
BGO operating current	$I_{BGO}$ <sup>Notes 1, 8</sup>					2.00	12.20	$\text{mA}$	
SNOOZE operating current	$I_{SNOZ}$ <sup>Note 1</sup>	ADC operation	While the mode is shifting <sup>Note 10</sup>			0.50	0.60	$\text{mA}$	
			During A/D conversion, in low voltage mode, $AV_{REFP} = V_{DD} = 3.0\text{ V}$			1.20	1.44	$\text{mA}$	
		CSI/UART operation			0.70	0.84	$\text{mA}$		
LCD operating current	$I_{LCD1}$ <sup>Notes 1, 12, 13</sup>	External resistance division method	$f_{LCD} = f_{SUB}$ LCD clock = $128\text{ Hz}$	1/3 bias, four time slices	$V_{DD} = 5.0\text{ V}$ , $V_{L4} = 5.0\text{ V}$		0.04	0.20	$\mu\text{A}$
		Internal voltage boosting method	$f_{LCD} = f_{SUB}$ LCD clock = $128\text{ Hz}$	1/3 bias, four time slices	$V_{DD} = 3.0\text{ V}$ , $V_{L4} = 3.0\text{ V}$ ( $V_{LCD} = 04\text{H}$ )		0.85	2.20	$\mu\text{A}$
	$V_{DD} = 5.0\text{ V}$ , $V_{L4} = 5.1\text{ V}$ ( $V_{LCD} = 12\text{H}$ )					1.55	3.70	$\mu\text{A}$	
	$I_{LCD3}$ <sup>Note 1, 12</sup>	Capacitor split method	$f_{LCD} = f_{SUB}$ LCD clock = $128\text{ Hz}$	1/3 bias, four time slices	$V_{DD} = 3.0\text{ V}$ , $V_{L4} = 3.0\text{ V}$		0.20	0.50	$\mu\text{A}$

(Notes and Remarks are listed on the next page.)

- Notes**
1. Current flowing to  $V_{DD}$ .
  2. When high speed on-chip oscillator and high-speed system clock are stopped.
  3. Current flowing only to the real-time clock 2 (excluding the operating current of the low-speed on-chip oscillator and the XT1 oscillator). The value of the current for the RL78 microcontrollers is the sum of the values of either  $I_{DD1}$  or  $I_{DD2}$ , and  $I_{RTC}$ , when the real-time clock 2 operates in operation mode or HALT mode. When the low-speed on-chip oscillator is selected,  $I_{FIL}$  should be added.  $I_{DD2}$  subsystem clock operation includes the operational current of real-time clock 2.
  4. Current flowing only to the 12-bit interval timer (excluding the operating current of the low-speed on-chip oscillator and the XT1 oscillator). The value of the current for the RL78 microcontrollers is the sum of the values of either  $I_{DD1}$  or  $I_{DD2}$ , and  $I_{TMKA}$ , when the 12-bit interval timer operates in operation mode or HALT mode. When the low-speed on-chip oscillator is selected,  $I_{FIL}$  should be added.
  5. Current flowing only to the watchdog timer (including the operating current of the low-speed on-chip oscillator). The current value of the RL78 microcontrollers is the sum of  $I_{DD1}$ ,  $I_{DD2}$  or  $I_{DD3}$  and  $I_{WDT}$  when the watchdog timer operates.
  6. Current flowing only to the A/D converter. The current value of the RL78 microcontrollers is the sum of  $I_{DD1}$  or  $I_{DD2}$  and  $I_{ADC}$  when the A/D converter operates in an operation mode or the HALT mode.
  7. Current flowing only to the LVD circuit. The current value of the RL78 microcontrollers is the sum of  $I_{DD1}$ ,  $I_{DD2}$  or  $I_{DD3}$  and  $I_{LVD}$  when the LVD circuit operates.
  8. Current flowing only during data flash rewrite.
  9. Current flowing only during self programming.
  10. For shift time to the SNOOZE mode, see **21.3.3 SNOOZE mode** in the RL78/L13 User's Manual.
  11. Current flowing only to the comparator circuit. The current value of the RL78 microcontrollers is the sum of  $I_{DD1}$ ,  $I_{DD2}$  or  $I_{DD3}$  and  $I_{CMP}$  when the comparator circuit operates.
  12. Current flowing only to the LCD controller/driver. The value of the current for the RL78 microcontrollers is the sum of the supply current ( $I_{DD1}$  or  $I_{DD2}$ ) and LCD operating current ( $I_{LCD1}$ ,  $I_{LCD2}$ , or  $I_{LCD3}$ ), when the LCD controller/driver operates in operation mode or HALT mode. However, not including the current flowing into the LCD panel. Conditions of the TYP. value and MAX. value are as follows.
    - Setting 20 pins as the segment function and blinking all
    - Selecting  $f_{SUB}$  for system clock when LCD clock = 128 Hz (LCDC0 = 07H)
    - Setting four time slices and 1/3 bias
  13. Not including the current flowing into the external division resistor when using the external resistance division method.

- Remarks**
1.  $f_{IL}$ : Low-speed on-chip oscillator clock frequency
  2.  $f_{SUB}$ : Subsystem clock frequency (XT1 clock oscillation frequency)
  3.  $f_{CLK}$ : CPU/peripheral hardware clock frequency
  4. The temperature condition for the TYP. value is  $T_A = 25^\circ\text{C}$ .

## 3.4 AC Characteristics

(TA =  $-40$  to  $+105^\circ\text{C}$ ,  $2.4\text{ V} \leq V_{DD} \leq 5.5\text{ V}$ ,  $V_{SS} = 0\text{ V}$ )

Parameter	Symbol	Conditions		MIN.	TYP.	MAX.	Unit	
Instruction cycle (minimum instruction execution time)	T <sub>CY</sub>	Main system clock (f <sub>MAIN</sub> ) operation	HS (high-speed main) mode	2.7 V ≤ V <sub>DD</sub> ≤ 5.5 V	0.0417	1	μs	
				2.4 V ≤ V <sub>DD</sub> < 2.7 V	0.0625	1	μs	
		Subsystem clock (f <sub>SUB</sub> ) operation		2.4 V ≤ V <sub>DD</sub> ≤ 5.5 V	28.5	30.5	31.3	μs
		In the self programming mode	HS (high-speed main) mode	2.7 V ≤ V <sub>DD</sub> ≤ 5.5 V	0.0417	1	μs	
2.4 V ≤ V <sub>DD</sub> < 2.7 V	0.0625			1	μs			
External system clock frequency	f <sub>EX</sub>	2.7 V ≤ V <sub>DD</sub> ≤ 5.5 V		1.0		20.0	MHz	
		2.4 V ≤ V <sub>DD</sub> < 2.7 V		1.0		16.0	MHz	
	f <sub>EXS</sub>			32		35	kHz	
External system clock input high-level width, low-level width	t <sub>EXH</sub> , t <sub>EXL</sub>	2.7 V ≤ V <sub>DD</sub> ≤ 5.5 V		24			ns	
		2.4 V ≤ V <sub>DD</sub> < 2.7 V		30			ns	
	t <sub>EXHS</sub> , t <sub>EXLS</sub>			13.7			μs	
TI00 to TI07 input high-level width, low-level width	t <sub>TIH</sub> , t <sub>TIL</sub>			1/f <sub>MCK</sub> +10			ns	
TO00 to TO07, TKBO0 <sup>Note</sup> , TKBO01-0 to TKBO01-2 <sup>Note</sup> output frequency	f <sub>TO</sub>	HS (high-speed main) mode	4.0 V ≤ V <sub>DD</sub> ≤ 5.5 V			12	MHz	
			2.7 V ≤ V <sub>DD</sub> < 4.0 V			8	MHz	
			2.4 V ≤ V <sub>DD</sub> < 2.7 V			4	MHz	
PCLBUZ0, PCLBUZ1 output frequency	f <sub>PCL</sub>	HS (high-speed main) mode	4.0 V ≤ V <sub>DD</sub> ≤ 5.5 V			16	MHz	
			2.7 V ≤ V <sub>DD</sub> < 4.0 V			8	MHz	
			2.4 V ≤ V <sub>DD</sub> < 2.7 V			4	MHz	
Interrupt input high-level width, low-level width	t <sub>INTH</sub> , t <sub>INTL</sub>	INTP0 to INTP7	2.4 V ≤ V <sub>DD</sub> ≤ 5.5 V	1			μs	
Key interrupt input high-level width, low-level width	t <sub>KRH</sub> , t <sub>KRL</sub>	KR0 to KR7	2.4 V ≤ V <sub>DD</sub> ≤ 5.5 V	250			ns	
IH-PWM output restart input high-level width	t <sub>IHR</sub>	INTP0 to INTP7		2			f <sub>CLK</sub>	
TMKB2 forced output stop input high-level width	t <sub>IHR</sub>	INTP0 to INTP2		2			f <sub>CLK</sub>	
RESET low-level width	t <sub>RSL</sub>			10			μs	

(Note and Remark are listed on the next page.)

**Note** Specification under conditions where the duty factor is 50%.

**Remark**  $f_{MCK}$ : Timer array unit operation clock frequency

(Operation clock to be set by the CKS<sub>mn0</sub>, CKS<sub>mn1</sub> bits of timer mode register mn (TMR<sub>mn</sub>)

m: Unit number (m = 0), n: Channel number (n = 0 to 7))

**Minimum Instruction Execution Time during Main System Clock Operation**

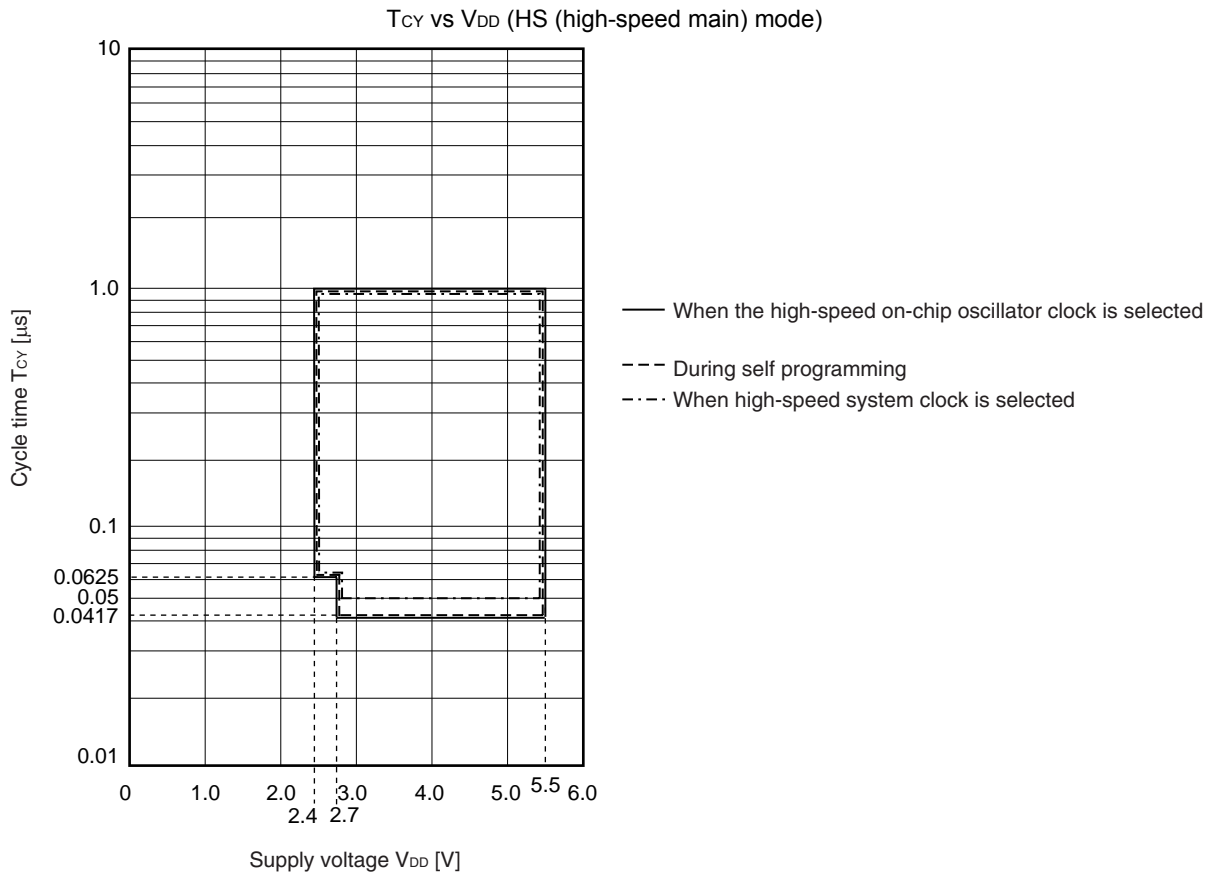

**AC Timing Test Points**

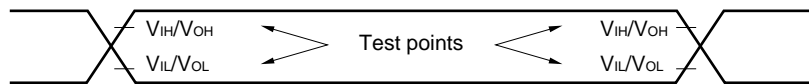

**External System Clock Timing**

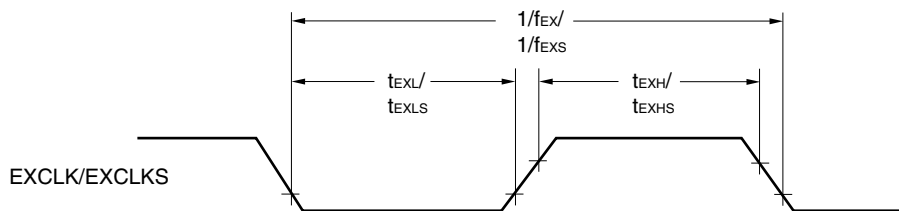



**TI/TO Timing**

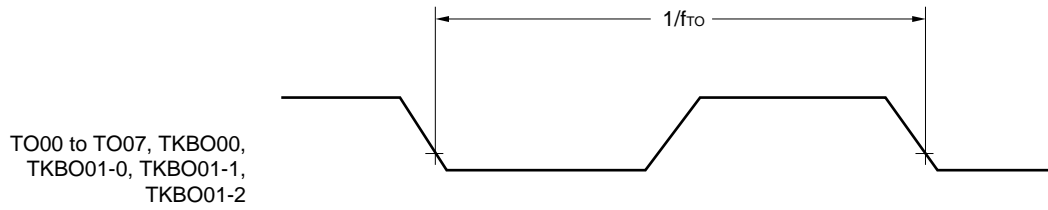
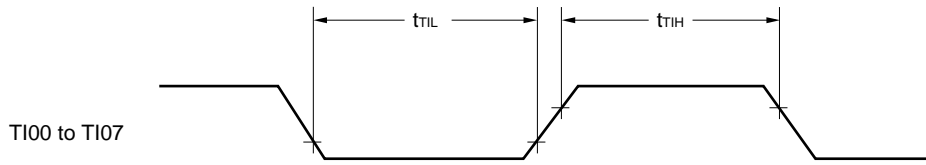

**Interrupt Request Input Timing**

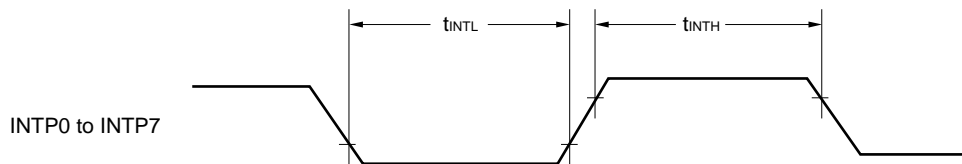

**Key Interrupt Input Timing**

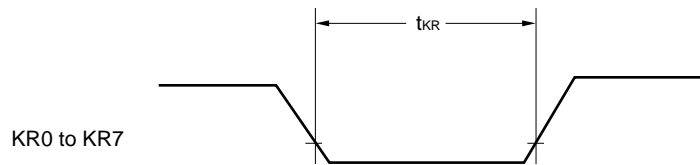

**RESET Input Timing**

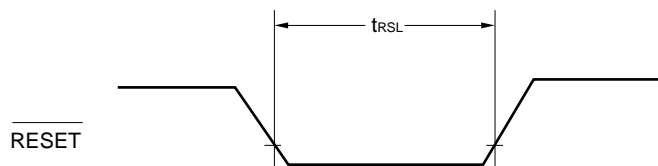

### 3.5 Peripheral Functions Characteristics

#### AC Timing Test Points

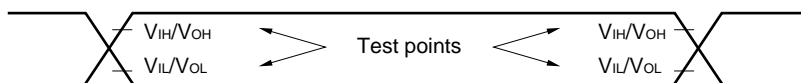

#### 3.5.1 Serial array unit

##### (1) During communication at same potential (UART mode)

(T<sub>A</sub> = -40 to +105°C, 2.4 V ≤ V<sub>DD</sub> ≤ 5.5 V, V<sub>SS</sub> = 0 V)

Parameter	Symbol	Conditions	HS (high-speed main) Mode		Unit
			MIN.	MAX.	
Transfer rate <sup>Note</sup>		Theoretical value of the maximum transfer rate f <sub>CLK</sub> = 24 MHz, f <sub>MCK</sub> = f <sub>CLK</sub>		f <sub>MCK</sub> /12	bps
				2.0	Mbps

**Note** Transfer rate in the SNOOZE mode is 4800 bps only.

**Caution** Select the normal input buffer for the RxDq pin and the normal output mode for the TxDq pin by using port input mode register g (PIMg) and port output mode register g (POMg).

#### UART mode connection diagram (during communication at same potential)

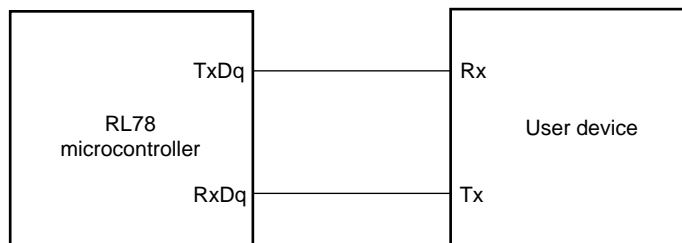

#### UART mode bit width (during communication at same potential) (reference)

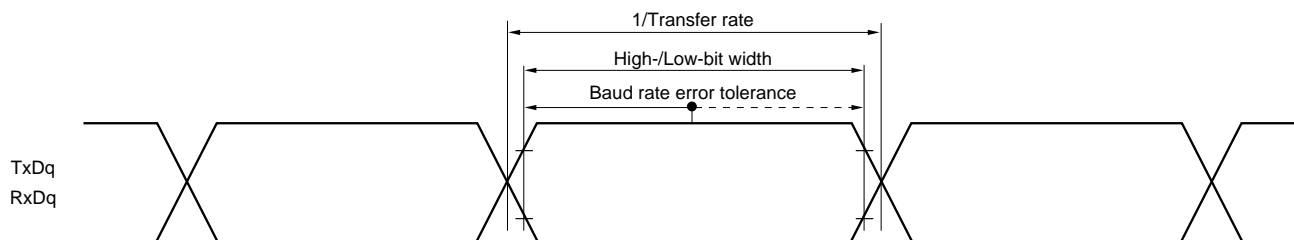

- Remarks 1.** q: UART number (q = 0 to 3), g: PIM and POM number (g = 0, 1, 3)
- 2.** f<sub>MCK</sub>: Serial array unit operation clock frequency  
(Operation clock to be set by the CKSmn bit of serial mode register mn (SMRmn). m: Unit number, n: Channel number (mn = 00 to 03, 10 to 13))

**(2) During communication at same potential (CSI mode) (master mode, SCKp... internal clock output)**  
**( $T_A = -40$  to  $+105^\circ\text{C}$ ,  $2.4\text{ V} \leq V_{DD} \leq 5.5\text{ V}$ ,  $V_{SS} = 0\text{ V}$ )**

Parameter	Symbol	Conditions	HS (high-speed main) Mode		Unit
			MIN.	MAX.	
SCKp cycle time	$t_{\text{KCY1}}$	$2.7\text{ V} \leq V_{DD} \leq 5.5\text{ V}$	334 <sup>Note 1</sup>		ns
		$2.4\text{ V} \leq V_{DD} \leq 5.5\text{ V}$	500 <sup>Note 1</sup>		ns
SCKp high-/low-level width	$t_{\text{KH1}}$ , $t_{\text{KL1}}$	$4.0\text{ V} \leq V_{DD} \leq 5.5\text{ V}$	$t_{\text{KCY1}}/2 - 24$		ns
		$2.7\text{ V} \leq V_{DD} \leq 5.5\text{ V}$	$t_{\text{KCY1}}/2 - 36$		ns
		$2.4\text{ V} \leq V_{DD} \leq 5.5\text{ V}$	$t_{\text{KCY1}}/2 - 76$		ns
Slp setup time (to SCKp $\uparrow$ ) <sup>Note 2</sup>	$t_{\text{SIK1}}$	$4.0\text{ V} \leq V_{DD} \leq 5.5\text{ V}$	66		ns
		$2.7\text{ V} \leq V_{DD} \leq 5.5\text{ V}$	66		ns
		$2.4\text{ V} \leq V_{DD} \leq 5.5\text{ V}$	113		ns
Slp hold time (from SCKp $\uparrow$ ) <sup>Note 3</sup>	$t_{\text{SH1}}$		38		ns
Delay time from SCKp $\downarrow$ to SOp output <sup>Note 4</sup>	$t_{\text{KSO1}}$	$C = 30\text{ pF}$ <sup>Note 5</sup>		50	ns

**Notes 1.** The value must also be equal to or more than  $4/f_{\text{CLK}}$ .

2. When DAPmn = 0 and CKPmn = 0, or DAPmn = 1 and CKPmn = 1. The Slp setup time becomes “to SCKp $\downarrow$ ” when DAPmn = 0 and CKPmn = 1, or DAPmn = 1 and CKPmn = 0.
3. When DAPmn = 0 and CKPmn = 0, or DAPmn = 1 and CKPmn = 1. The Slp hold time becomes “from SCKp $\downarrow$ ” when DAPmn = 0 and CKPmn = 1, or DAPmn = 1 and CKPmn = 0.
4. When DAPmn = 0 and CKPmn = 0, or DAPmn = 1 and CKPmn = 1. The delay time to SOp output becomes “from SCKp $\uparrow$ ” when DAPmn = 0 and CKPmn = 1, or DAPmn = 1 and CKPmn = 0.
5. C is the load capacitance of the SCKp and SOp output lines.

**Caution** Select the normal input buffer for the Slp pin and the normal output mode for the SOp pin and SCKp pin by using port input mode register g (PIMg) and port output mode register g (POMg).

- Remarks 1.** p: CSI number (p = 00, 10), m: Unit number (m = 0), n: Channel number (n = 0, 2),  
g: PIM and POM numbers (g = 0, 1)
2.  $f_{\text{MCK}}$ : Serial array unit operation clock frequency  
(Operation clock to be set by the CKSmn bit of serial mode register mn (SMRmn). m: Unit number, n: Channel number (mn = 00, 02))

**(3) During communication at same potential (CSI mode) (slave mode, SCKp... external clock input)**  
**( $T_A = -40$  to  $+105^\circ\text{C}$ ,  $2.4\text{ V} \leq V_{DD} \leq 5.5\text{ V}$ ,  $V_{SS} = 0\text{ V}$ )**

Parameter	Symbol	Conditions		HS (high-speed main) Mode		Unit
				MIN.	MAX.	
SCKp cycle time <sup>Note 5</sup>	$t_{KCY2}$	$4.0\text{ V} \leq V_{DD} \leq 5.5\text{ V}$	$f_{MCK} > 20\text{ MHz}$	$16/f_{MCK}$		ns
			$f_{MCK} \leq 20\text{ MHz}$	$12/f_{MCK}$		ns
		$2.7\text{ V} \leq V_{DD} \leq 5.5\text{ V}$	$f_{MCK} > 16\text{ MHz}$	$16/f_{MCK}$		ns
			$f_{MCK} \leq 16\text{ MHz}$	$12/f_{MCK}$		ns
	$2.4\text{ V} \leq V_{DD} \leq 5.5\text{ V}$		$12/f_{MCK}$ and 1000		ns	
SCKp high-/low-level width	$t_{KH2}, t_{KL2}$	$4.0\text{ V} \leq V_{DD} \leq 5.5\text{ V}$		$t_{KCY2}/2-14$		ns
		$2.7\text{ V} \leq V_{DD} \leq 5.5\text{ V}$		$t_{KCY2}/2-16$		ns
		$2.4\text{ V} \leq V_{DD} \leq 5.5\text{ V}$		$t_{KCY2}/2-36$		ns
Slp setup time (to SCKp $\uparrow$ ) <sup>Note 1</sup>	$t_{SIK2}$	$2.7\text{ V} \leq V_{DD} \leq 5.5\text{ V}$		$1/f_{MCK}+40$		ns
		$2.4\text{ V} \leq V_{DD} \leq 5.5\text{ V}$		$1/f_{MCK}+60$		ns
Slp hold time (from SCKp $\uparrow$ ) <sup>Note 2</sup>	$t_{KSI2}$			$1/f_{MCK}+62$		ns
Delay time from SCKp $\downarrow$ to SOp output <sup>Note 3</sup>	$t_{KSO2}$	$C = 30\text{ pF}$ <sup>Note 4</sup>	$2.7\text{ V} \leq V_{DD} \leq 5.5\text{ V}$		$2/f_{MCK}+66$	ns
			$2.4\text{ V} \leq V_{DD} \leq 5.5\text{ V}$		$2/f_{MCK}+113$	ns

- Notes**
1. When  $DAPmn = 0$  and  $CKPmn = 0$ , or  $DAPmn = 1$  and  $CKPmn = 1$ . The Slp setup time becomes “to SCKp $\downarrow$ ” when  $DAPmn = 0$  and  $CKPmn = 1$ , or  $DAPmn = 1$  and  $CKPmn = 0$ .
  2. When  $DAPmn = 0$  and  $CKPmn = 0$ , or  $DAPmn = 1$  and  $CKPmn = 1$ . The Slp hold time becomes “from SCKp $\downarrow$ ” when  $DAPmn = 0$  and  $CKPmn = 1$ , or  $DAPmn = 1$  and  $CKPmn = 0$ .
  3. When  $DAPmn = 0$  and  $CKPmn = 0$ , or  $DAPmn = 1$  and  $CKPmn = 1$ . The delay time to SOp output becomes “from SCKp $\uparrow$ ” when  $DAPmn = 0$  and  $CKPmn = 1$ , or  $DAPmn = 1$  and  $CKPmn = 0$ .
  4. C is the load capacitance of the SOp output lines.
  5. Transfer rate in SNOOZE mode: MAX. 1 Mbps

**Caution** Select the normal input buffer for the Slp pin and SCKp pin and the normal output mode for the SOp pin by using port input mode register g (PIMg) and port output mode register g (POMg).

- Remarks**
1. p: CSI number (p = 00, 10), m: Unit number (m = 0), n: Channel number (n = 0, 2),  
g: PIM number (g = 0, 1)
  2.  $f_{MCK}$ : Serial array unit operation clock frequency  
(Operation clock to be set by the CKSmn bit of serial mode register mn (SMRmn). m: Unit number, n: Channel number (mn = 00, 02))

**CSI mode connection diagram (during communication at same potential)**

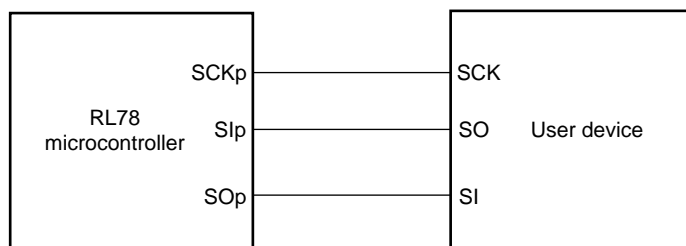

**CSI mode serial transfer timing (during communication at same potential)  
(When DAPmn = 0 and CKPmn = 0, or DAPmn = 1 and CKPmn = 1.)**

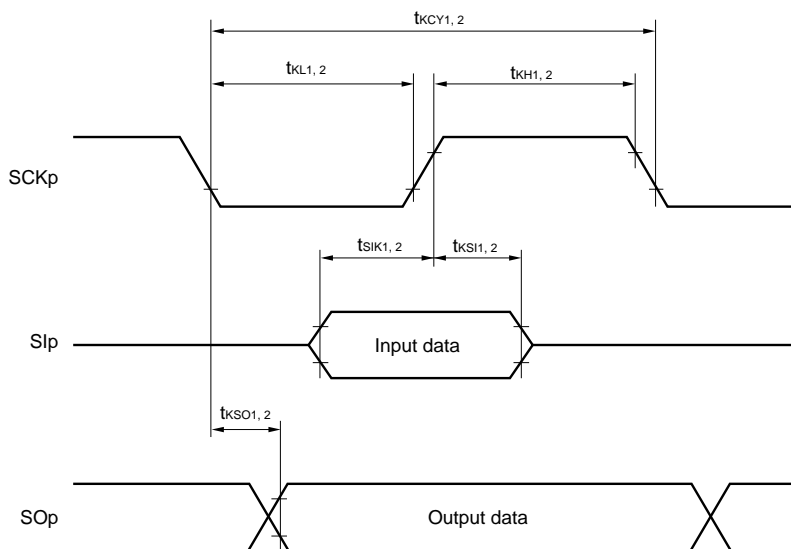

**CSI mode serial transfer timing (during communication at same potential)  
(When DAPmn = 0 and CKPmn = 1, or DAPmn = 1 and CKPmn = 0.)**

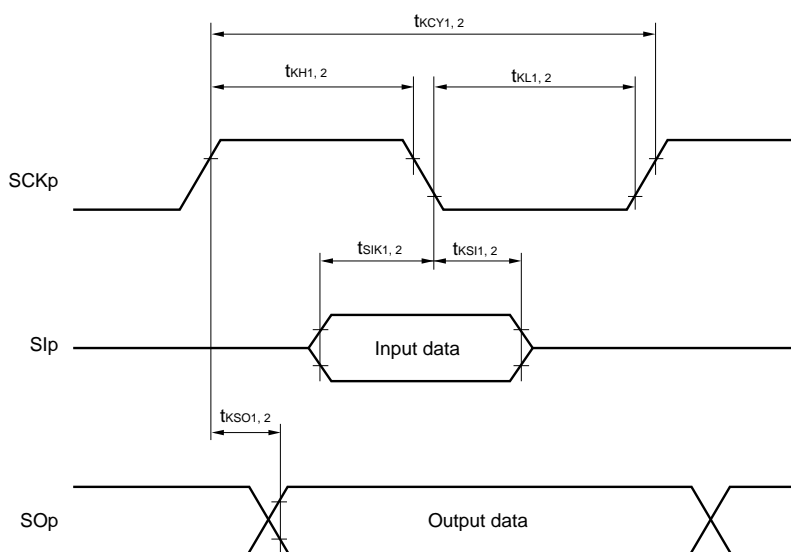

- Remarks 1. p: CSI number (p = 00, 10)
- 2. m: Unit number, n: Channel number (mn = 00, 02)

**(4) During communication at same potential (simplified I<sup>2</sup>C mode)****( $T_A = -40$  to  $+105^\circ\text{C}$ ,  $2.4\text{ V} \leq V_{DD} \leq 5.5\text{ V}$ ,  $V_{SS} = 0\text{ V}$ )**

Parameter	Symbol	Conditions	HS (high-speed main) Mode		Unit
			MIN.	MAX.	
SCLr clock frequency	$f_{SCL}$	$2.7\text{ V} \leq V_{DD} \leq 5.5\text{ V}$ , $C_b = 50\text{ pF}$ , $R_b = 2.7\text{ k}\Omega$		400 <sup>Note 1</sup>	kHz
		$2.4\text{ V} \leq V_{DD} \leq 5.5\text{ V}$ , $C_b = 100\text{ pF}$ , $R_b = 3\text{ k}\Omega$		100 <sup>Note 1</sup>	
Hold time when SCLr = "L"	$t_{LOW}$	$2.7\text{ V} \leq V_{DD} \leq 5.5\text{ V}$ , $C_b = 50\text{ pF}$ , $R_b = 2.7\text{ k}\Omega$	1200		ns
		$2.4\text{ V} \leq V_{DD} \leq 5.5\text{ V}$ , $C_b = 100\text{ pF}$ , $R_b = 3\text{ k}\Omega$	4600		
Hold time when SCLr = "H"	$t_{HIGH}$	$2.7\text{ V} \leq V_{DD} \leq 5.5\text{ V}$ , $C_b = 50\text{ pF}$ , $R_b = 2.7\text{ k}\Omega$	1200		ns
		$2.4\text{ V} \leq V_{DD} \leq 5.5\text{ V}$ , $C_b = 100\text{ pF}$ , $R_b = 3\text{ k}\Omega$	4600		
Data setup time (reception)	$t_{SU:DAT}$	$2.7\text{ V} \leq V_{DD} \leq 5.5\text{ V}$ , $C_b = 50\text{ pF}$ , $R_b = 2.7\text{ k}\Omega$	$1/f_{MCK} + 220$ <sup>Note 2</sup>		ns
		$2.4\text{ V} \leq V_{DD} \leq 5.5\text{ V}$ , $C_b = 100\text{ pF}$ , $R_b = 3\text{ k}\Omega$	$1/f_{MCK} + 580$ <sup>Note 2</sup>		
Data hold time (transmission)	$t_{HD:DAT}$	$2.7\text{ V} \leq V_{DD} \leq 5.5\text{ V}$ , $C_b = 50\text{ pF}$ , $R_b = 2.7\text{ k}\Omega$	0	770	ns
		$2.4\text{ V} \leq V_{DD} \leq 5.5\text{ V}$ , $C_b = 100\text{ pF}$ , $R_b = 3\text{ k}\Omega$	0	1420	

- Notes**
- The value must also be equal to or less than  $f_{MCK}/4$ .
  - Set the  $f_{MCK}$  value to keep the hold time of SCLr = "L" and SCLr = "H".

**Caution** Select the normal input buffer and the N-ch open drain output ( $V_{DD}$  tolerance) mode for the SDAr pin and the normal output mode for the SCLr pin by using port input mode register g (PIMg) and port output mode register g (POMg).

(Remarks are listed on the next page.)

**Simplified I<sup>2</sup>C mode connection diagram (during communication at same potential)**

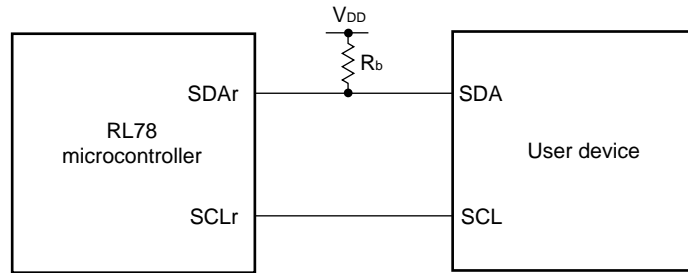

**Simplified I<sup>2</sup>C mode serial transfer timing (during communication at same potential)**

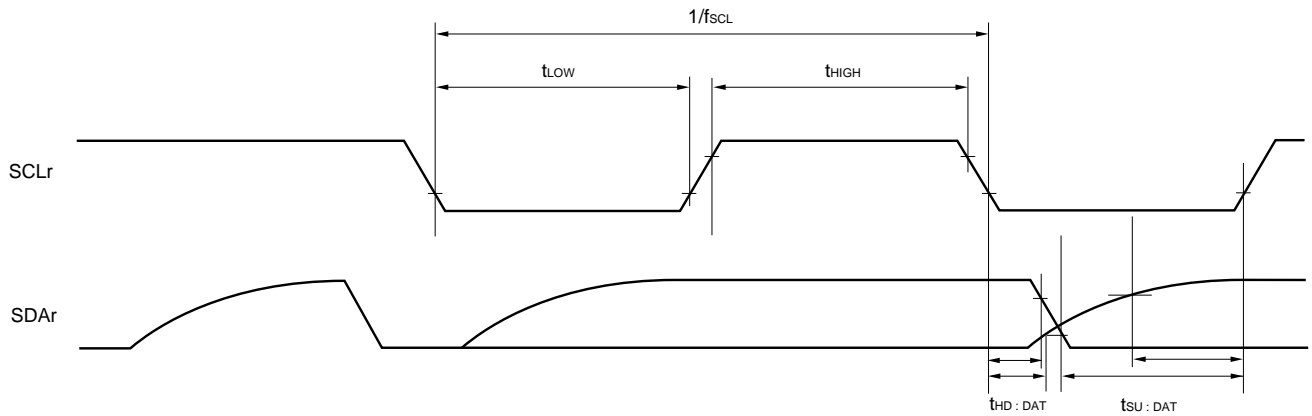

**Remarks 1.**  $R_b[\Omega]$ : Communication line (SDAr) pull-up resistance,  $C_b[F]$ : Communication line (SDAr, SCLr) load capacitance

**2.** r: IIC number (r = 00, 10), g: PIM and POM number (g = 0, 1)

**3.**  $f_{MCK}$ : Serial array unit operation clock frequency

(Operation clock to be set by the CKSmn bit of serial mode register mn (SMRmn). m: Unit number (m = 0),

n: Channel number (n = 0-3), mn = 00-03, 10-13)

<R>

**(5) Communication at different potential (1.8 V, 2.5 V, 3 V) (UART mode) (1/2)****( $T_A = -40$  to  $+105^\circ\text{C}$ ,  $2.4\text{ V} \leq V_{DD} \leq 5.5\text{ V}$ ,  $V_{SS} = 0\text{ V}$ )**

Parameter	Symbol	Conditions	HS (high-speed main) Mode		Unit	
			MIN.	MAX.		
Transfer rate		Reception	$4.0\text{ V} \leq V_{DD} \leq 5.5\text{ V}$ , $2.7\text{ V} \leq V_b \leq 4.0\text{ V}$		$f_{MCK}/12^{\text{Note}}$	bps
			Theoretical value of the maximum transfer rate $f_{CLK} = 24\text{ MHz}$ , $f_{MCK} = f_{CLK}$		2.0	Mbps
			$2.7\text{ V} \leq V_{DD} < 4.0\text{ V}$ , $2.3\text{ V} \leq V_b \leq 2.7\text{ V}$		$f_{MCK}/12^{\text{Note}}$	bps
			Theoretical value of the maximum transfer rate $f_{CLK} = 24\text{ MHz}$ , $f_{MCK} = f_{CLK}$		2.0	Mbps
			$2.4\text{ V} \leq V_{DD} < 3.3\text{ V}$ , $1.6\text{ V} \leq V_b \leq 2.0\text{ V}$		$f_{MCK}/12^{\text{Note}}$	bps
			Theoretical value of the maximum transfer rate $f_{CLK} = 24\text{ MHz}$ , $f_{MCK} = f_{CLK}$		2.0	Mbps

**Note** Transfer rate in SNOOZE mode is 4800 bps only.

**Caution** Select the TTL input buffer for the RxDq pin and the N-ch open drain output ( $V_{DD}$  tolerance) mode for the TxDq pin by using port input mode register g (PIMg) and port output mode register g (POMg). For  $V_{IH}$  and  $V_{IL}$ , see the DC characteristics with TTL input buffer selected.

- Remarks**
1.  $V_b[V]$ : Communication line voltage
  2. q: UART number (q = 0 to 3), g: PIM and POM number (g = 0, 1, 3)
  3.  $f_{MCK}$ : Serial array unit operation clock frequency  
(Operation clock to be set by the CKSmn bit of serial mode register mn (SMRmn). m: Unit number, n: Channel number (mn = 00 to 03, 10 to 13))



**(5) Communication at different potential (1.8 V, 2.5 V, 3 V) (UART mode) (2/2)****(T<sub>A</sub> = -40 to +105°C, 2.4 V ≤ V<sub>DD</sub> ≤ 5.5 V, V<sub>SS</sub> = 0 V)**

Parameter	Symbol	Conditions	HS (high-speed main) Mode		Unit	
			MIN.	MAX.		
Transfer rate		Transmission	4.0 V ≤ V <sub>DD</sub> ≤ 5.5 V, 2.7 V ≤ V <sub>b</sub> ≤ 4.0 V		<b>Note 1</b>	bps
			Theoretical value of the maximum transfer rate C <sub>b</sub> = 50 pF, R <sub>b</sub> = 1.4 kΩ, V <sub>b</sub> = 2.7 V		2.0 <sup>Note 2</sup>	Mbps
			2.7 V ≤ V <sub>DD</sub> < 4.0 V, 2.3 V ≤ V <sub>b</sub> ≤ 2.7 V		<b>Note 3</b>	bps
			Theoretical value of the maximum transfer rate C <sub>b</sub> = 50 pF, R <sub>b</sub> = 2.7 kΩ, V <sub>b</sub> = 2.3 V		1.2 <sup>Note 4</sup>	Mbps
			2.4 V ≤ V <sub>DD</sub> < 3.3 V, 1.6 V ≤ V <sub>b</sub> ≤ 2.0 V		<b>Note 5</b>	bps
Theoretical value of the maximum transfer rate C <sub>b</sub> = 50 pF, R <sub>b</sub> = 5.5 kΩ, V <sub>b</sub> = 1.6 V			0.43 <sup>Note 6</sup>	Mbps		

**Notes 1.** The smaller maximum transfer rate derived by using f<sub>MCK</sub>/12 or the following expression is the valid maximum transfer rate.

Expression for calculating the transfer rate when 4.0 V ≤ V<sub>DD</sub> ≤ 5.5 V and 2.7 V ≤ V<sub>b</sub> ≤ 4.0 V

$$\text{Maximum transfer rate} = \frac{1}{\{-C_b \times R_b \times \ln(1 - \frac{2.2}{V_b})\} \times 3} \text{ [bps]}$$

$$\text{Baud rate error (theoretical value)} = \frac{\frac{1}{\text{Transfer rate} \times 2} - \{-C_b \times R_b \times \ln(1 - \frac{2.2}{V_b})\}}{(\frac{1}{\text{Transfer rate}}) \times \text{Number of transferred bits}} \times 100 \text{ [%]}$$

\* This value is the theoretical value of the relative difference between the transmission and reception sides.

**2.** This value as an example is calculated when the conditions described in the “Conditions” column are met. Refer to **Note 1** above to calculate the maximum transfer rate under conditions of the customer.

**3.** The smaller maximum transfer rate derived by using f<sub>MCK</sub>/12 or the following expression is the valid maximum transfer rate.

Expression for calculating the transfer rate when 2.7 V ≤ V<sub>DD</sub> < 4.0 V and 2.3 V ≤ V<sub>b</sub> ≤ 2.7 V

$$\text{Maximum transfer rate} = \frac{1}{\{-C_b \times R_b \times \ln(1 - \frac{2.0}{V_b})\} \times 3} \text{ [bps]}$$

$$\text{Baud rate error (theoretical value)} = \frac{\frac{1}{\text{Transfer rate} \times 2} - \{-C_b \times R_b \times \ln(1 - \frac{2.0}{V_b})\}}{(\frac{1}{\text{Transfer rate}}) \times \text{Number of transferred bits}} \times 100 \text{ [%]}$$

\* This value is the theoretical value of the relative difference between the transmission and reception sides.

**4.** This value as an example is calculated when the conditions described in the “Conditions” column are met. Refer to **Note 3** above to calculate the maximum transfer rate under conditions of the customer.

**Notes 5.** The smaller maximum transfer rate derived by using  $f_{\text{MCK}}/12$  or the following expression is the valid maximum transfer rate.

Expression for calculating the transfer rate when  $2.4\text{ V} \leq V_{\text{DD}} < 3.3\text{ V}$  and  $1.6\text{ V} \leq V_b \leq 2.0\text{ V}$

$$\text{Maximum transfer rate} = \frac{1}{\{-C_b \times R_b \times \ln(1 - \frac{1.5}{V_b})\} \times 3} \text{ [bps]}$$

$$\text{Baud rate error (theoretical value)} = \frac{\frac{1}{\text{Transfer rate} \times 2} - \{-C_b \times R_b \times \ln(1 - \frac{1.5}{V_b})\}}{(\frac{1}{\text{Transfer rate}}) \times \text{Number of transferred bits}} \times 100 \text{ [%]}$$

\* This value is the theoretical value of the relative difference between the transmission and reception sides.

6. This value as an example is calculated when the conditions described in the “Conditions” column are met. Refer to **Note 5** above to calculate the maximum transfer rate under conditions of the customer.

**Caution** Select the TTL input buffer for the RxDq pin and the N-ch open drain output ( $V_{\text{DD}}$  tolerance) mode for the TxDq pin by using port input mode register g (PIMg) and port output mode register g (POMg). For  $V_{\text{IH}}$  and  $V_{\text{IL}}$ , see the DC characteristics with TTL input buffer selected.

**UART mode connection diagram (during communication at different potential)**

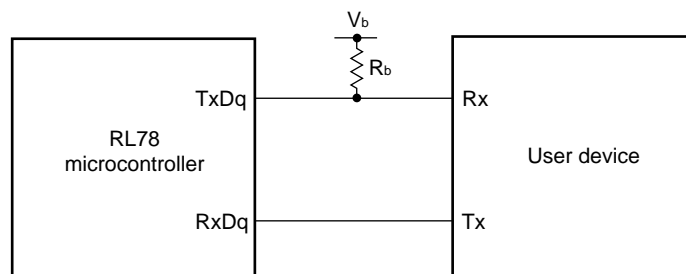

### UART mode bit width (during communication at different potential) (reference)



- Remarks**
1.  $R_b[\Omega]$ : Communication line (TxDq) pull-up resistance,  $C_b[\text{F}]$ : Communication line (TxDq) load capacitance,  $V_b[\text{V}]$ : Communication line voltage
  2. q: UART number (q = 0 to 3), g: PIM and POM number (g = 0, 1, 3)
  3.  $f_{\text{MCK}}$ : Serial array unit operation clock frequency  
(Operation clock to be set by the CKSmn bit of serial mode register mn (SMRmn).  
m: Unit number, n: Channel number (mn = 00 to 03, 10 to 13))

**(6) Communication at different potential (1.8 V, 2.5 V, 3 V) (CSI mode) (master mode, SCKp... internal clock output) (1/2)**  
**( $T_A = -40$  to  $+105^\circ\text{C}$ ,  $2.4\text{ V} \leq V_{DD} \leq 5.5\text{ V}$ ,  $V_{SS} = 0\text{ V}$ )**

Parameter	Symbol	Conditions	HS (high-speed main) Mode		Unit
			MIN.	MAX.	
SCKp cycle time	$t_{KCY1}$	$t_{KCY1} \geq 4/f_{CLK}$ $4.0\text{ V} \leq V_{DD} \leq 5.5\text{ V}$ , $2.7\text{ V} \leq V_b \leq 4.0\text{ V}$ , $C_b = 30\text{ pF}$ , $R_b = 1.4\text{ k}\Omega$	600		ns
		$2.7\text{ V} \leq V_{DD} < 4.0\text{ V}$ , $2.3\text{ V} \leq V_b \leq 2.7\text{ V}$ , $C_b = 30\text{ pF}$ , $R_b = 2.7\text{ k}\Omega$	1000		ns
		$2.4\text{ V} \leq V_{DD} < 3.3\text{ V}$ , $1.6\text{ V} \leq V_b \leq 1.8\text{ V}$ , $C_b = 30\text{ pF}$ , $R_b = 5.5\text{ k}\Omega$	2300		ns
SCKp high-level width	$t_{KH1}$	$4.0\text{ V} \leq V_{DD} \leq 5.5\text{ V}$ , $2.7\text{ V} \leq V_b \leq 4.0\text{ V}$ , $C_b = 30\text{ pF}$ , $R_b = 1.4\text{ k}\Omega$	$t_{KCY1}/2 - 150$		ns
		$2.7\text{ V} \leq V_{DD} < 4.0\text{ V}$ , $2.3\text{ V} \leq V_b \leq 2.7\text{ V}$ , $C_b = 30\text{ pF}$ , $R_b = 2.7\text{ k}\Omega$	$t_{KCY1}/2 - 340$		ns
		$2.4\text{ V} \leq V_{DD} < 3.3\text{ V}$ , $1.6\text{ V} \leq V_b \leq 2.0\text{ V}$ , $C_b = 30\text{ pF}$ , $R_b = 5.5\text{ k}\Omega$	$t_{KCY1}/2 - 916$		ns
SCKp low-level width	$t_{KL1}$	$4.0\text{ V} \leq V_{DD} \leq 5.5\text{ V}$ , $2.7\text{ V} \leq V_b \leq 4.0\text{ V}$ , $C_b = 30\text{ pF}$ , $R_b = 1.4\text{ k}\Omega$	$t_{KCY1}/2 - 24$		ns
		$2.7\text{ V} \leq V_{DD} < 4.0\text{ V}$ , $2.3\text{ V} \leq V_b \leq 2.7\text{ V}$ , $C_b = 30\text{ pF}$ , $R_b = 2.7\text{ k}\Omega$	$t_{KCY1}/2 - 36$		ns
		$2.4\text{ V} \leq V_{DD} < 3.3\text{ V}$ , $1.6\text{ V} \leq V_b \leq 2.0\text{ V}$ , $C_b = 30\text{ pF}$ , $R_b = 5.5\text{ k}\Omega$	$t_{KCY1}/2 - 100$		ns
Slp setup time (to SCKp $\uparrow$ ) <sup>Note 1</sup>	$t_{SIK1}$	$4.0\text{ V} \leq V_{DD} \leq 5.5\text{ V}$ , $2.7\text{ V} \leq V_b \leq 4.0\text{ V}$ , $C_b = 30\text{ pF}$ , $R_b = 1.4\text{ k}\Omega$	162		ns
		$2.7\text{ V} \leq V_{DD} < 4.0\text{ V}$ , $2.3\text{ V} \leq V_b \leq 2.7\text{ V}$ , $C_b = 30\text{ pF}$ , $R_b = 2.7\text{ k}\Omega$	354		ns
		$2.4\text{ V} \leq V_{DD} < 3.3\text{ V}$ , $1.6\text{ V} \leq V_b \leq 2.0\text{ V}$ , $C_b = 30\text{ pF}$ , $R_b = 5.5\text{ k}\Omega$	958		ns
Slp hold time (from SCKp $\uparrow$ ) <sup>Note 1</sup>	$t_{SH1}$	$4.0\text{ V} \leq V_{DD} \leq 5.5\text{ V}$ , $2.7\text{ V} \leq V_b \leq 4.0\text{ V}$ , $C_b = 30\text{ pF}$ , $R_b = 1.4\text{ k}\Omega$	38		ns
		$2.7\text{ V} \leq V_{DD} < 4.0\text{ V}$ , $2.3\text{ V} \leq V_b \leq 2.7\text{ V}$ , $C_b = 30\text{ pF}$ , $R_b = 2.7\text{ k}\Omega$	38		ns
		$2.4\text{ V} \leq V_{DD} < 3.3\text{ V}$ , $1.6\text{ V} \leq V_b \leq 2.0\text{ V}$ , $C_b = 30\text{ pF}$ , $R_b = 5.5\text{ k}\Omega$	38		ns
Delay time from SCKp $\downarrow$ to SOp output <sup>Note 1</sup>	$t_{KSO1}$	$4.0\text{ V} \leq V_{DD} \leq 5.5\text{ V}$ , $2.7\text{ V} \leq V_b \leq 4.0\text{ V}$ , $C_b = 30\text{ pF}$ , $R_b = 1.4\text{ k}\Omega$		200	ns
		$2.7\text{ V} \leq V_{DD} < 4.0\text{ V}$ , $2.3\text{ V} \leq V_b \leq 2.7\text{ V}$ , $C_b = 30\text{ pF}$ , $R_b = 2.7\text{ k}\Omega$		390	ns
		$2.4\text{ V} \leq V_{DD} < 3.3\text{ V}$ , $1.6\text{ V} \leq V_b \leq 2.0\text{ V}$ , $C_b = 30\text{ pF}$ , $R_b = 5.5\text{ k}\Omega$		966	ns

(Note, Caution and Remark are listed on the next page.)

**(6) Communication at different potential (1.8 V, 2.5 V, 3 V) (CSI mode) (master mode, SCKp... internal clock output) (2/2)**  
**( $T_A = -40$  to  $+105^\circ\text{C}$ ,  $2.4\text{ V} \leq V_{DD} \leq 5.5\text{ V}$ ,  $V_{SS} = 0\text{ V}$ )**

Parameter	Symbol	Conditions	HS (high-speed main) Mode		Unit
			MIN.	MAX.	
Slp setup time (to SCKp↓) <sup>Note 2</sup>	$t_{SIK1}$	$4.0\text{ V} \leq V_{DD} \leq 5.5\text{ V}$ , $2.7\text{ V} \leq V_b \leq 4.0\text{ V}$ , $C_b = 20\text{ pF}$ , $R_b = 1.4\text{ k}\Omega$	88		ns
		$2.7\text{ V} \leq V_{DD} < 4.0\text{ V}$ , $2.3\text{ V} \leq V_b \leq 2.7\text{ V}$ , $C_b = 20\text{ pF}$ , $R_b = 2.7\text{ k}\Omega$	88		ns
		$2.4\text{ V} \leq V_{DD} < 3.3\text{ V}$ , $1.6\text{ V} \leq V_b \leq 2.0\text{ V}$ , $C_b = 30\text{ pF}$ , $R_b = 5.5\text{ k}\Omega$	220		ns
Slp hold time (from SCKp↓) <sup>Note 2</sup>	$t_{KSH1}$	$4.0\text{ V} \leq V_{DD} \leq 5.5\text{ V}$ , $2.7\text{ V} \leq V_b \leq 4.0\text{ V}$ , $C_b = 20\text{ pF}$ , $R_b = 1.4\text{ k}\Omega$	38		ns
		$2.7\text{ V} \leq V_{DD} < 4.0\text{ V}$ , $2.3\text{ V} \leq V_b \leq 2.7\text{ V}$ , $C_b = 20\text{ pF}$ , $R_b = 2.7\text{ k}\Omega$	38		ns
		$2.4\text{ V} \leq V_{DD} < 3.3\text{ V}$ , $1.6\text{ V} \leq V_b \leq 2.0\text{ V}$ , $C_b = 30\text{ pF}$ , $R_b = 5.5\text{ k}\Omega$	38		ns
Delay time from SCKp↑ to SOp output <sup>Note 2</sup>	$t_{KSO1}$	$4.0\text{ V} \leq V_{DD} \leq 5.5\text{ V}$ , $2.7\text{ V} \leq V_b \leq 4.0\text{ V}$ , $C_b = 20\text{ pF}$ , $R_b = 1.4\text{ k}\Omega$		50	ns
		$2.7\text{ V} \leq V_{DD} < 4.0\text{ V}$ , $2.3\text{ V} \leq V_b \leq 2.7\text{ V}$ , $C_b = 20\text{ pF}$ , $R_b = 2.7\text{ k}\Omega$		50	ns
		$2.4\text{ V} \leq V_{DD} < 3.3\text{ V}$ , $1.6\text{ V} \leq V_b \leq 2.0\text{ V}$ , $C_b = 30\text{ pF}$ , $R_b = 5.5\text{ k}\Omega$		50	ns

**CSI mode connection diagram (during communication at different potential)**

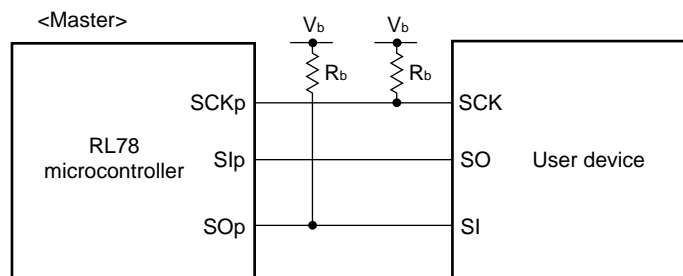

- Notes**
1. When  $DAP_{mn} = 0$  and  $CKP_{mn} = 0$ , or  $DAP_{mn} = 1$  and  $CKP_{mn} = 1$ .
  2. When  $DAP_{mn} = 0$  and  $CKP_{mn} = 1$ , or  $DAP_{mn} = 1$  and  $CKP_{mn} = 0$ .

**Caution** Select the TTL input buffer for the Slp pin and the N-ch open drain output ( $V_{DD}$  tolerance) mode for the SOp pin and SCKp pin by using port input mode register g (PIMg) and port output mode register g (POMg). For  $V_{IH}$  and  $V_{IL}$ , see the DC characteristics with TTL input buffer selected.

- Remarks**
1.  $R_b[\Omega]$ : Communication line (SCKp, SOp) pull-up resistance,  $C_b[\text{F}]$ : Communication line (SCKp, SOp) load capacitance,  $V_b[\text{V}]$ : Communication line voltage
  2. p: CSI number (p = 00, 10), m: Unit number, n: Channel number (mn = 00, 02),  
g: PIM and POM number (g = 0, 1)
  3.  $f_{MCK}$ : Serial array unit operation clock frequency  
(Operation clock to be set by the CKSmn bit of serial mode register mn (SMRmn).  
m: Unit number, n: Channel number (mn = 00))

**CSI mode serial transfer timing (master mode) (during communication at different potential)**  
**(When DAPmn = 0 and CKPmn = 0, or DAPmn = 1 and CKPmn = 1.)**

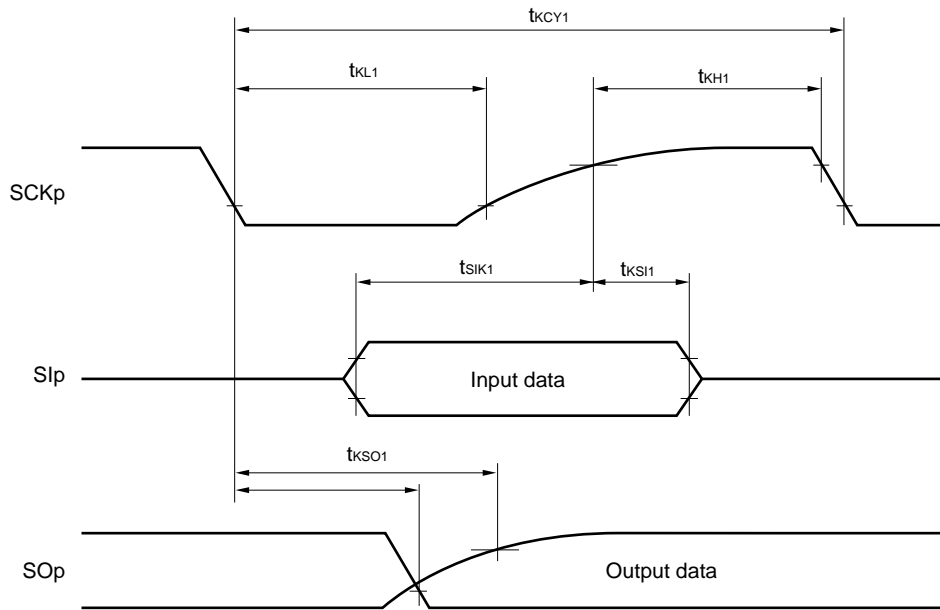

**CSI mode serial transfer timing (master mode) (during communication at different potential)**  
**(When DAPmn = 0 and CKPmn = 1, or DAPmn = 1 and CKPmn = 0.)**

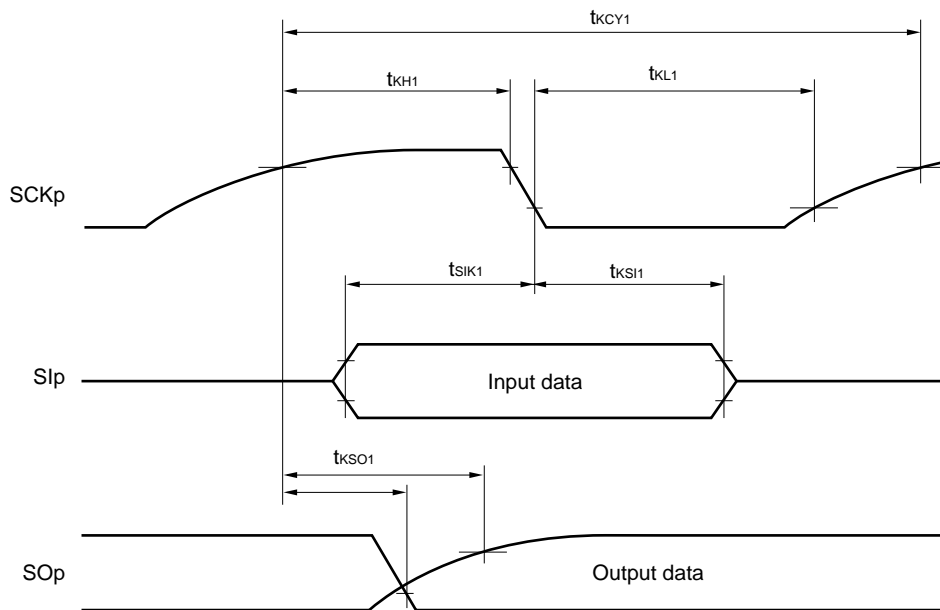

**Remark** p: CSI number (p = 00, 10), m: Unit number, n: Channel number (mn = 00, 02),  
 g: PIM and POM number (g = 0, 1)

**(7) Communication at different potential (1.8 V, 2.5 V, 3 V) (CSI mode) (slave mode, SCKp... external clock input)**  
**( $T_A = -40$  to  $+105^\circ\text{C}$ ,  $2.4\text{ V} \leq V_{DD} \leq 5.5\text{ V}$ ,  $V_{SS} = 0\text{ V}$ )**

Parameter	Symbol	Conditions	HS (high-speed main) Mode		Unit
			MIN.	MAX.	
SCKp cycle time <sup>Note 1</sup>	$t_{KY2}$	$4.0\text{ V} \leq V_{DD} \leq 5.5\text{ V}$ , $2.7\text{ V} \leq V_b \leq 4.0\text{ V}$	$20\text{ MHz} < f_{MCK}$	$24/f_{MCK}$	ns
			$8\text{ MHz} < f_{MCK} \leq 20\text{ MHz}$	$20/f_{MCK}$	ns
			$4\text{ MHz} < f_{MCK} \leq 8\text{ MHz}$	$16/f_{MCK}$	ns
			$f_{MCK} \leq 4\text{ MHz}$	$12/f_{MCK}$	ns
		$2.7\text{ V} \leq V_{DD} < 4.0\text{ V}$ , $2.3\text{ V} \leq V_b \leq 2.7\text{ V}$	$20\text{ MHz} < f_{MCK}$	$32/f_{MCK}$	ns
			$16\text{ MHz} < f_{MCK} \leq 20\text{ MHz}$	$28/f_{MCK}$	ns
			$8\text{ MHz} < f_{MCK} \leq 16\text{ MHz}$	$24/f_{MCK}$	ns
			$4\text{ MHz} < f_{MCK} \leq 8\text{ MHz}$	$16/f_{MCK}$	ns
		$2.4\text{ V} \leq V_{DD} < 3.3\text{ V}$ , $1.6\text{ V} \leq V_b \leq 2.0\text{ V}$	$f_{MCK} \leq 4\text{ MHz}$	$12/f_{MCK}$	ns
			$20\text{ MHz} < f_{MCK}$	$72/f_{MCK}$	ns
			$16\text{ MHz} < f_{MCK} \leq 20\text{ MHz}$	$64/f_{MCK}$	ns
			$8\text{ MHz} < f_{MCK} \leq 16\text{ MHz}$	$52/f_{MCK}$	ns
	$4\text{ MHz} < f_{MCK} \leq 8\text{ MHz}$	$32/f_{MCK}$	ns		
	$f_{MCK} \leq 4\text{ MHz}$	$20/f_{MCK}$	ns		
	SCKp high-/low-level width	$t_{KH2}, t_{KL2}$	$4.0\text{ V} \leq V_{DD} \leq 5.5\text{ V}$ , $2.7\text{ V} \leq V_b \leq 4.0\text{ V}$	$t_{KY2}/2 - 24$	ns
			$2.7\text{ V} \leq V_{DD} < 4.0\text{ V}$ , $2.3\text{ V} \leq V_b \leq 2.7\text{ V}$	$t_{KY2}/2 - 36$	ns
$2.4\text{ V} \leq V_{DD} < 3.3\text{ V}$ , $1.6\text{ V} \leq V_b \leq 2.0\text{ V}$			$t_{KY2}/2 - 100$	ns	
Slp setup time (to SCKp $\uparrow$ ) <sup>Note 2</sup>	$t_{SIK2}$	$4.0\text{ V} \leq V_{DD} \leq 5.5\text{ V}$ , $2.7\text{ V} \leq V_b \leq 4.0\text{ V}$	$1/f_{MCK} + 40$	ns	
		$2.7\text{ V} \leq V_{DD} < 4.0\text{ V}$ , $2.3\text{ V} \leq V_b \leq 2.7\text{ V}$	$1/f_{MCK} + 40$	ns	
		$2.4\text{ V} \leq V_{DD} < 3.3\text{ V}$ , $1.6\text{ V} \leq V_b \leq 2.0\text{ V}$	$1/f_{MCK} + 60$	ns	
Slp hold time (from SCKp $\uparrow$ ) <sup>Note 3</sup>	$t_{KSI2}$	$4.0\text{ V} \leq V_{DD} \leq 5.5\text{ V}$ , $2.7\text{ V} \leq V_b \leq 4.0\text{ V}$	$1/f_{MCK} + 62$	ns	
		$2.7\text{ V} \leq V_{DD} < 4.0\text{ V}$ , $2.3\text{ V} \leq V_b \leq 2.7\text{ V}$	$1/f_{MCK} + 62$	ns	
		$2.4\text{ V} \leq V_{DD} \leq 3.3\text{ V}$ , $1.6\text{ V} \leq V_b \leq 2.0\text{ V}$	$1/f_{MCK} + 62$	ns	
Delay time from SCKp $\downarrow$ to SOp output <sup>Note 4</sup>	$t_{KSO2}$	$4.0\text{ V} \leq V_{DD} \leq 5.5\text{ V}$ , $2.7\text{ V} \leq V_b \leq 4.0\text{ V}$ , $C_b = 30\text{ pF}$ , $R_b = 1.4\text{ k}\Omega$		$2/f_{MCK} + 240$	ns
		$2.7\text{ V} \leq V_{DD} < 4.0\text{ V}$ , $2.3\text{ V} \leq V_b \leq 2.7\text{ V}$ , $C_b = 30\text{ pF}$ , $R_b = 2.7\text{ k}\Omega$		$2/f_{MCK} + 428$	ns
		$2.4\text{ V} \leq V_{DD} < 3.3\text{ V}$ , $1.6\text{ V} \leq V_b \leq 2.0\text{ V}$ , $C_b = 30\text{ pF}$ , $R_b = 5.5\text{ k}\Omega$		$2/f_{MCK} + 1146$	ns

(Notes and Caution are listed on the next page, and Remarks are listed on the page after the next page.)

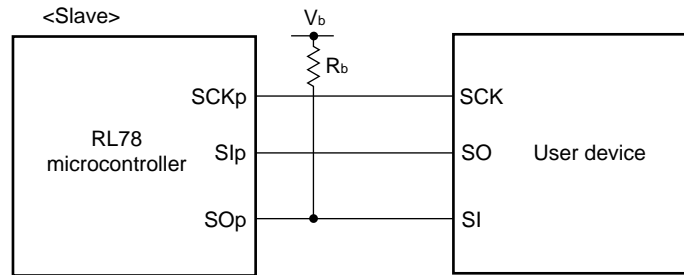
**CSI mode connection diagram (during communication at different potential)**

- Notes**
1. Transfer rate in SNOOZE mode: MAX. 1 Mbps
  2. When  $DAPmn = 0$  and  $CKPmn = 0$ , or  $DAPmn = 1$  and  $CKPmn = 1$ . The  $Slp$  setup time becomes “to  $SCKp\downarrow$ ” when  $DAPmn = 0$  and  $CKPmn = 1$ , or  $DAPmn = 1$  and  $CKPmn = 0$ .
  3. When  $DAPmn = 0$  and  $CKPmn = 0$ , or  $DAPmn = 1$  and  $CKPmn = 1$ . The  $Slp$  hold time becomes “from  $SCKp\downarrow$ ” when  $DAPmn = 0$  and  $CKPmn = 1$ , or  $DAPmn = 1$  and  $CKPmn = 0$ .
  4. When  $DAPmn = 0$  and  $CKPmn = 0$ , or  $DAPmn = 1$  and  $CKPmn = 1$ . The delay time to  $SOp$  output becomes “from  $SCKp\uparrow$ ” when  $DAPmn = 0$  and  $CKPmn = 1$ , or  $DAPmn = 1$  and  $CKPmn = 0$ .

**Caution** Select the TTL input buffer for the  $Slp$  pin and  $SCKp$  pin and the N-ch open drain output ( $V_{DD}$  tolerance) mode for the  $SOp$  pin by using port input mode register  $g$  (PIMg) and port output mode register  $g$  (POMg). For  $V_{IH}$  and  $V_{IL}$ , see the DC characteristics with TTL input buffer selected.



**CSI mode serial transfer timing (slave mode) (during communication at different potential)  
(When DAPmn = 0 and CKPmn = 0, or DAPmn = 1 and CKPmn = 1.)**

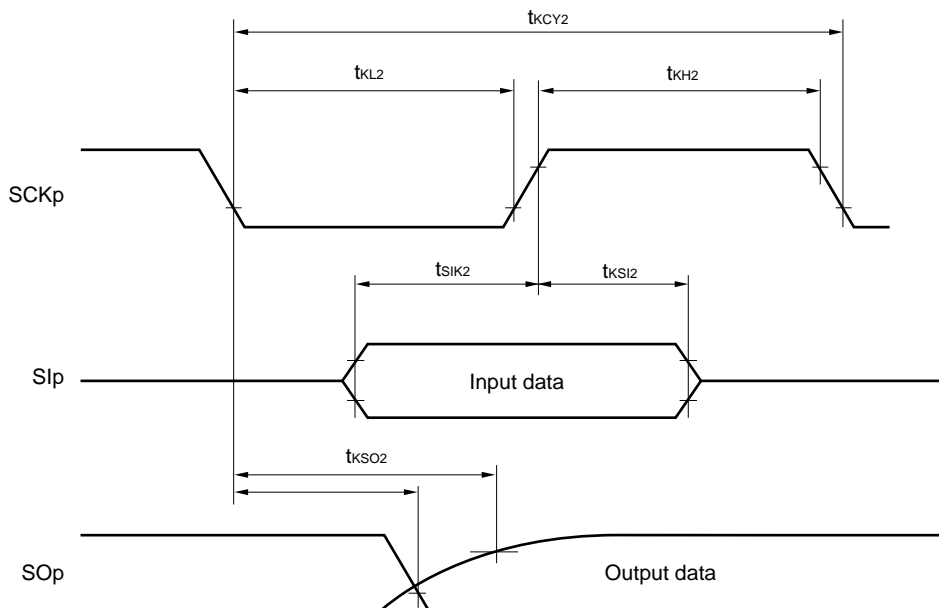

**CSI mode serial transfer timing (slave mode) (during communication at different potential)  
(When DAPmn = 0 and CKPmn = 1, or DAPmn = 1 and CKPmn = 0.)**

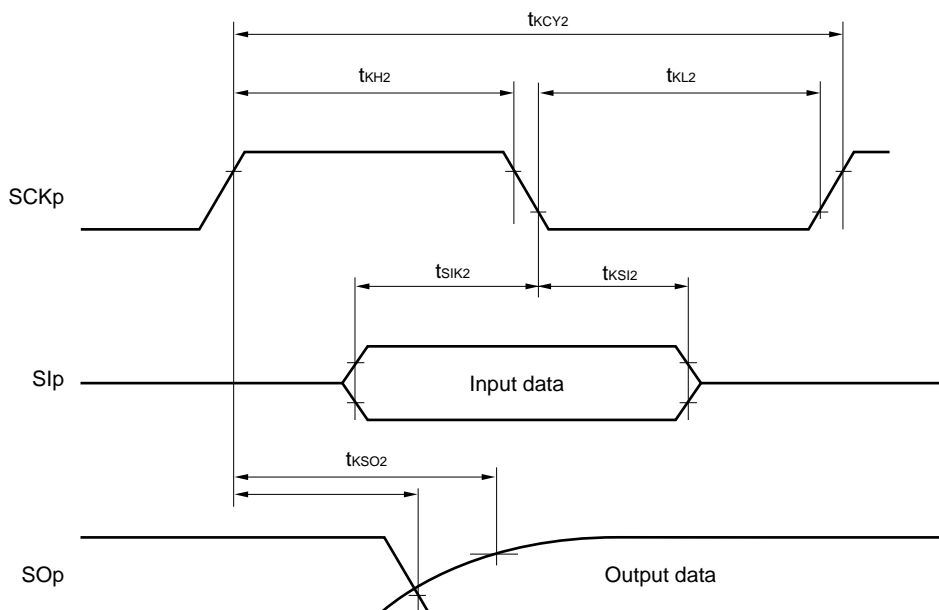

- Remarks 1.**  $R_b[\Omega]$ : Communication line (SO<sub>p</sub>) pull-up resistance,  $C_b[F]$ : Communication line (SO<sub>p</sub>) load capacitance,  $V_b[V]$ : Communication line voltage
- 2.** p: CSI number (p = 00, 10), m: Unit number, n: Channel number (mn = 00, 02), g: PIM and POM number (g = 0, 1)
- 3.**  $f_{MCK}$ : Serial array unit operation clock frequency  
(Operation clock to be set by the CKS<sub>m</sub>n bit of serial mode register mn (SMR<sub>m</sub>n)  
m: Unit number, n: Channel number (mn = 00, 02))

**(8) Communication at different potential (1.8 V, 2.5 V, 3 V) (simplified I<sup>2</sup>C mode) (1/2)****( $T_A = -40$  to  $+105^\circ\text{C}$ ,  $2.4\text{ V} \leq V_{DD} \leq 5.5\text{ V}$ ,  $V_{SS} = 0\text{ V}$ )**

Parameter	Symbol	Conditions	HS (high-speed main) Mode		Unit
			MIN.	MAX.	
SCLr clock frequency	f <sub>SCL</sub>	$4.0\text{ V} \leq V_{DD} \leq 5.5\text{ V}$ , $2.7\text{ V} \leq V_b \leq 4.0\text{ V}$ , $C_b = 50\text{ pF}$ , $R_b = 2.7\text{ k}\Omega$		400 <sup>Note 1</sup>	kHz
		$2.7\text{ V} \leq V_{DD} < 4.0\text{ V}$ , $2.3\text{ V} \leq V_b \leq 2.7\text{ V}$ , $C_b = 50\text{ pF}$ , $R_b = 2.7\text{ k}\Omega$		400 <sup>Note 1</sup>	kHz
		$4.0\text{ V} \leq V_{DD} \leq 5.5\text{ V}$ , $2.7\text{ V} \leq V_b \leq 4.0\text{ V}$ , $C_b = 100\text{ pF}$ , $R_b = 2.8\text{ k}\Omega$		100 <sup>Note 1</sup>	kHz
		$2.7\text{ V} \leq V_{DD} < 4.0\text{ V}$ , $2.3\text{ V} \leq V_b \leq 2.7\text{ V}$ , $C_b = 100\text{ pF}$ , $R_b = 2.7\text{ k}\Omega$		100 <sup>Note 1</sup>	kHz
		$2.4\text{ V} \leq V_{DD} < 3.3\text{ V}$ , $1.6\text{ V} \leq V_b \leq 2.0\text{ V}$ , $C_b = 100\text{ pF}$ , $R_b = 5.5\text{ k}\Omega$		100 <sup>Note 1</sup>	kHz
Hold time when SCLr = "L"	t <sub>LOW</sub>	$4.0\text{ V} \leq V_{DD} \leq 5.5\text{ V}$ , $2.7\text{ V} \leq V_b \leq 4.0\text{ V}$ , $C_b = 50\text{ pF}$ , $R_b = 2.7\text{ k}\Omega$	1200		ns
		$2.7\text{ V} \leq V_{DD} < 4.0\text{ V}$ , $2.3\text{ V} \leq V_b \leq 2.7\text{ V}$ , $C_b = 50\text{ pF}$ , $R_b = 2.7\text{ k}\Omega$	1200		ns
		$4.0\text{ V} \leq V_{DD} \leq 5.5\text{ V}$ , $2.7\text{ V} \leq V_b \leq 4.0\text{ V}$ , $C_b = 100\text{ pF}$ , $R_b = 2.8\text{ k}\Omega$	4600		ns
		$2.7\text{ V} \leq V_{DD} < 4.0\text{ V}$ , $2.3\text{ V} \leq V_b \leq 2.7\text{ V}$ , $C_b = 100\text{ pF}$ , $R_b = 2.7\text{ k}\Omega$	4600		ns
		$2.4\text{ V} \leq V_{DD} < 3.3\text{ V}$ , $1.6\text{ V} \leq V_b \leq 2.0\text{ V}$ , $C_b = 100\text{ pF}$ , $R_b = 5.5\text{ k}\Omega$	4650		ns
Hold time when SCLr = "H"	t <sub>HIGH</sub>	$4.0\text{ V} \leq V_{DD} \leq 5.5\text{ V}$ , $2.7\text{ V} \leq V_b \leq 4.0\text{ V}$ , $C_b = 50\text{ pF}$ , $R_b = 2.7\text{ k}\Omega$	620		ns
		$2.7\text{ V} \leq V_{DD} < 4.0\text{ V}$ , $2.3\text{ V} \leq V_b < 2.7\text{ V}$ , $C_b = 50\text{ pF}$ , $R_b = 2.7\text{ k}\Omega$	500		ns
		$4.0\text{ V} \leq V_{DD} \leq 5.5\text{ V}$ , $2.7\text{ V} \leq V_b \leq 4.0\text{ V}$ , $C_b = 100\text{ pF}$ , $R_b = 2.8\text{ k}\Omega$	2700		ns
		$2.7\text{ V} \leq V_{DD} < 4.0\text{ V}$ , $2.3\text{ V} \leq V_b \leq 2.7\text{ V}$ , $C_b = 100\text{ pF}$ , $R_b = 2.7\text{ k}\Omega$	2400		ns
		$2.4\text{ V} \leq V_{DD} < 3.3\text{ V}$ , $1.6\text{ V} \leq V_b \leq 2.0\text{ V}$ , $C_b = 100\text{ pF}$ , $R_b = 5.5\text{ k}\Omega$	1830		ns

(Notes and Caution are listed on the next page, and Remarks are listed on the page after the next page.)

**(8) Communication at different potential (1.8 V, 2.5 V, 3 V) (simplified I<sup>2</sup>C mode) (2/2)****( $T_A = -40$  to  $+105^\circ\text{C}$ ,  $2.4\text{ V} \leq V_{DD} \leq 5.5\text{ V}$ ,  $V_{SS} = 0\text{ V}$ )**

Parameter	Symbol	Conditions	HS (high-speed main) Mode		Unit
			MIN.	MAX.	
Data setup time (reception)	$t_{SU:DAT}$	$4.0\text{ V} \leq V_{DD} \leq 5.5\text{ V}$ , $2.7\text{ V} \leq V_b \leq 4.0\text{ V}$ , $C_b = 50\text{ pF}$ , $R_b = 2.7\text{ k}\Omega$	$1/f_{MCK} + 340$ <sup>Note 2</sup>		ns
		$2.7\text{ V} \leq V_{DD} < 4.0\text{ V}$ , $2.3\text{ V} \leq V_b \leq 2.7\text{ V}$ , $C_b = 50\text{ pF}$ , $R_b = 2.7\text{ k}\Omega$	$1/f_{MCK} + 340$ <sup>Note 2</sup>		ns
		$4.0\text{ V} \leq V_{DD} \leq 5.5\text{ V}$ , $2.7\text{ V} \leq V_b \leq 4.0\text{ V}$ , $C_b = 100\text{ pF}$ , $R_b = 2.8\text{ k}\Omega$	$1/f_{MCK} + 760$ <sup>Note 2</sup>		ns
		$2.7\text{ V} \leq V_{DD} < 4.0\text{ V}$ , $2.3\text{ V} \leq V_b \leq 2.7\text{ V}$ , $C_b = 100\text{ pF}$ , $R_b = 2.7\text{ k}\Omega$	$1/f_{MCK} + 760$ <sup>Note 2</sup>		ns
		$2.4\text{ V} \leq V_{DD} < 3.3\text{ V}$ , $1.6\text{ V} \leq V_b \leq 2.0\text{ V}$ , $C_b = 100\text{ pF}$ , $R_b = 5.5\text{ k}\Omega$	$1/f_{MCK} + 570$ <sup>Note 2</sup>		ns
Data hold time (transmission)	$t_{HD:DAT}$	$4.0\text{ V} \leq V_{DD} \leq 5.5\text{ V}$ , $2.7\text{ V} \leq V_b \leq 4.0\text{ V}$ , $C_b = 50\text{ pF}$ , $R_b = 2.7\text{ k}\Omega$	0	770	ns
		$2.7\text{ V} \leq V_{DD} < 4.0\text{ V}$ , $2.3\text{ V} \leq V_b \leq 2.7\text{ V}$ , $C_b = 50\text{ pF}$ , $R_b = 2.7\text{ k}\Omega$	0	770	ns
		$4.0\text{ V} \leq V_{DD} \leq 5.5\text{ V}$ , $2.7\text{ V} \leq V_b \leq 4.0\text{ V}$ , $C_b = 100\text{ pF}$ , $R_b = 2.8\text{ k}\Omega$	0	1420	ns
		$2.7\text{ V} \leq V_{DD} < 4.0\text{ V}$ , $2.3\text{ V} \leq V_b \leq 2.7\text{ V}$ , $C_b = 100\text{ pF}$ , $R_b = 2.7\text{ k}\Omega$	0	1420	ns
		$2.4\text{ V} \leq V_{DD} < 3.3\text{ V}$ , $1.6\text{ V} \leq V_b \leq 2.0\text{ V}$ , $C_b = 100\text{ pF}$ , $R_b = 5.5\text{ k}\Omega$	0	1215	ns

**Notes 1.** The value must also be equal to or less than  $f_{MCK}/4$ .**2.** Set the  $f_{MCK}$  value to keep the hold time of SCLr = "L" and SCLr = "H".

**Caution** Select the TTL input buffer and the N-ch open drain output ( $V_{DD}$  tolerance) mode for the SDAr pin and the N-ch open drain output ( $V_{DD}$  tolerance) mode for the SCLr pin by using port input mode register g (PIMg) and port output mode register g (POMg). For  $V_{IH}$  and  $V_{IL}$ , see the DC characteristics with TTL input buffer selected.

(Remarks are listed on the next page.)

**Simplified I<sup>2</sup>C mode connection diagram (during communication at different potential)**

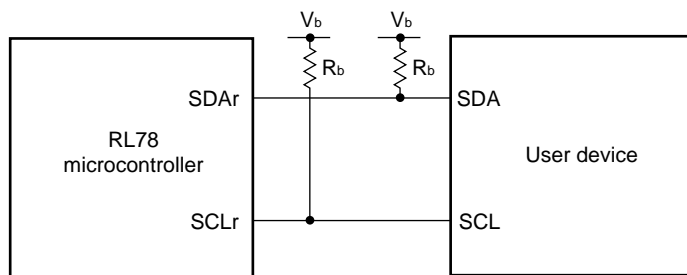

**Simplified I<sup>2</sup>C mode serial transfer timing (during communication at different potential)**

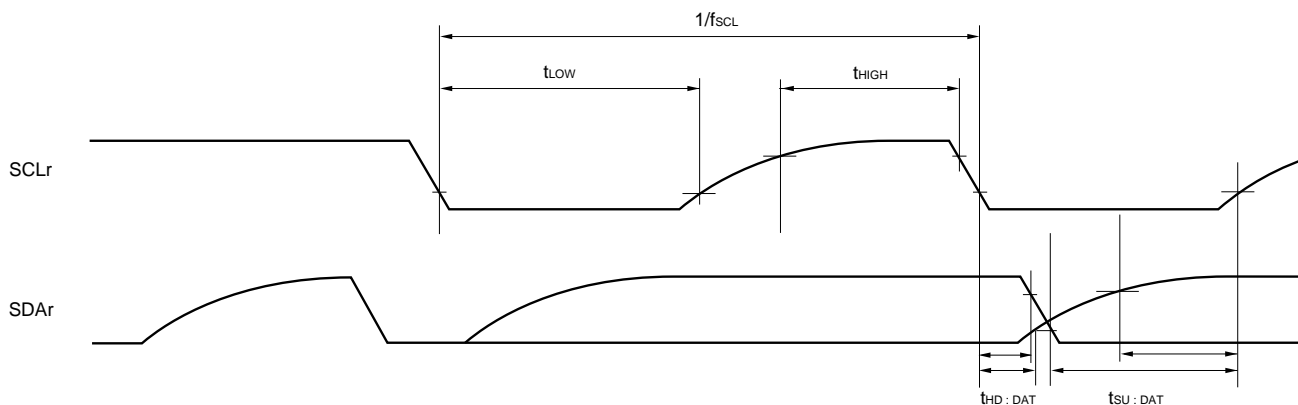

- Remarks**
1.  $R_b[\Omega]$ : Communication line (SDAr, SCLr) pull-up resistance,  $C_b[F]$ : Communication line (SDAr, SCLr) load capacitance,  $V_b[V]$ : Communication line voltage
  2. r: IIC number (r = 00, 10), g: PIM, POM number (g = 0, 1)
  3.  $f_{MCK}$ : Serial array unit operation clock frequency  
(Operation clock to be set by the CKSmn bit of serial mode register mn (SMRmn). m: Unit number, n: Channel number (mn = 00, 02))

### 3.5.2 Serial interface IICA

(T<sub>A</sub> = -40 to +105°C, 2.4 V ≤ V<sub>DD</sub> ≤ 5.5 V, V<sub>SS</sub> = 0 V)

Parameter	Symbol	Conditions	HS (high-speed main) Mode				Unit
			Standard Mode		Fast Mode		
			MIN.	MAX.	MIN.	MAX.	
SCLA0 clock frequency	f <sub>SCL</sub>	Fast mode: f <sub>CLK</sub> ≥ 3.5 MHz	–	–	0	400	kHz
		Normal mode: f <sub>CLK</sub> ≥ 1 MHz	0	100	–	–	
Setup time of restart condition	t <sub>SU:STA</sub>		4.7		0.6		μs
Hold time <sup>Note 1</sup>	t <sub>HD:STA</sub>		4.0		0.6		μs
Hold time when SCLA0 = "L"	t <sub>LOW</sub>		4.7		1.3		μs
Hold time when SCLA0 = "H"	t <sub>HIGH</sub>		4.0		0.6		μs
Data setup time (reception)	t <sub>SU:DAT</sub>		250		100		ns
Data hold time (transmission) <sup>Note 2</sup>	t <sub>HD:DAT</sub>		0 <sup>Note 3</sup>	3.45	0 <sup>Note 3</sup>	0.9	μs
Setup time of stop condition	t <sub>SU:STO</sub>		4.0		0.6		μs
Bus-free time	t <sub>BUF</sub>		4.7		1.3		μs

- Notes**
- The first clock pulse is generated after this period when the start/restart condition is detected.
  - The maximum value (MAX.) of t<sub>HD:DAT</sub> is during normal transfer and a wait state is inserted in the ACK (acknowledge) timing.

**Remark** The maximum value of C<sub>b</sub> (communication line capacitance) and the value of R<sub>b</sub> (communication line pull-up resistor) at that time in each mode are as follows.

Standard mode: C<sub>b</sub> = 400 pF, R<sub>b</sub> = 2.7 kΩ

Fast mode: C<sub>b</sub> = 320 pF, R<sub>b</sub> = 1.1 kΩ

IICA serial transfer timing

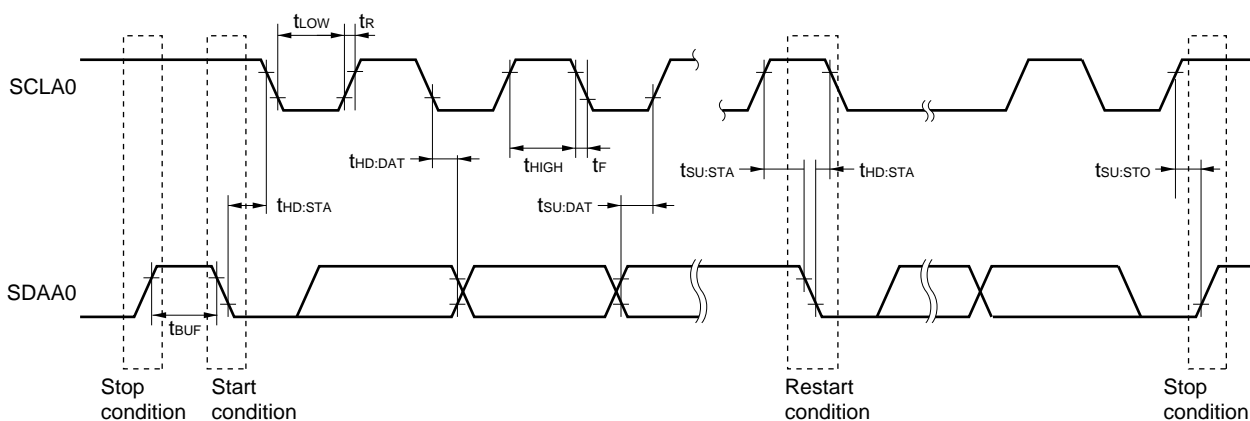

### 3.6 Analog Characteristics

#### 3.6.1 A/D converter characteristics

##### Classification of A/D converter characteristics

Reference Voltage Input channel	Reference voltage (+) = $AV_{REFP}$ Reference voltage (-) = $AV_{REFM}$	Reference voltage (+) = $V_{DD}$ Reference voltage (-) = $V_{SS}$	Reference voltage (+) = $V_{BGR}$ Reference voltage (-) = $AV_{REFM}$
ANI0, ANI1	–	See 3.6.1 (2).	See 3.6.1 (3).
ANI16 to ANI25	See 3.6.1 (1).		
Internal reference voltage Temperature sensor output voltage	See 3.6.1 (1).		–

(1) When reference voltage (+) =  $AV_{REFP}/ANI0$  ( $ADREFP1 = 0$ ,  $ADREFP0 = 1$ ), reference voltage (-) =  $AV_{REFM}/ANI1$  ( $ADREFM = 1$ ), target pins: ANI16 to ANI25, internal reference voltage, and temperature sensor output voltage

( $T_A = -40$  to  $+105^\circ\text{C}$ ,  $2.4\text{ V} \leq V_{DD} \leq 5.5\text{ V}$ ,  $V_{SS} = 0\text{ V}$ , Reference voltage (+) =  $AV_{REFP}$ , Reference voltage (-) =  $AV_{REFM} = 0\text{ V}$ )

Parameter	Symbol	Conditions	MIN.	TYP.	MAX.	Unit
Resolution	RES		8		10	bit
Overall error <sup>Note 1</sup>	AINL	10-bit resolution $AV_{REFP} = V_{DD}$ <sup>Note 3</sup>	$2.4\text{ V} \leq V_{DD} \leq 5.5\text{ V}$	1.2	$\pm 5.0$	LSB
Conversion time	$t_{CONV}$	10-bit resolution Target pin: ANI16 to ANI25	$3.6\text{ V} \leq V_{DD} \leq 5.5\text{ V}$	2.125	39	$\mu\text{s}$
			$2.7\text{ V} \leq V_{DD} \leq 5.5\text{ V}$	3.1875	39	$\mu\text{s}$
			$2.4\text{ V} \leq V_{DD} \leq 5.5\text{ V}$	17	39	$\mu\text{s}$
		10-bit resolution Target pin: Internal reference voltage, and temperature sensor output voltage (HS (high-speed main) mode)	$3.6\text{ V} \leq V_{DD} \leq 5.5\text{ V}$	2.375	39	$\mu\text{s}$
			$2.7\text{ V} \leq V_{DD} \leq 5.5\text{ V}$	3.5625	39	$\mu\text{s}$
			$2.4\text{ V} \leq V_{DD} \leq 5.5\text{ V}$	17	39	$\mu\text{s}$
Zero-scale error <sup>Notes 1, 2</sup>	$E_{ZS}$	10-bit resolution $AV_{REFP} = V_{DD}$ <sup>Note 3</sup>	$2.4\text{ V} \leq V_{DD} \leq 5.5\text{ V}$		$\pm 0.35$	%FSR
Full-scale error <sup>Notes 1, 2</sup>	$E_{FS}$	10-bit resolution $AV_{REFP} = V_{DD}$ <sup>Note 3</sup>	$2.4\text{ V} \leq V_{DD} \leq 5.5\text{ V}$		$\pm 0.35$	%FSR
Integral linearity error <sup>Note 1</sup>	ILE	10-bit resolution $AV_{REFP} = V_{DD}$ <sup>Note 3</sup>	$2.4\text{ V} \leq V_{DD} \leq 5.5\text{ V}$		$\pm 3.5$	LSB
Differential linearity error <sup>Note 1</sup>	DLE	10-bit resolution $AV_{REFP} = V_{DD}$ <sup>Note 3</sup>	$2.4\text{ V} \leq V_{DD} \leq 5.5\text{ V}$		$\pm 2.0$	LSB
Analog input voltage	$V_{AIN}$	ANI16 to ANI25	0		$AV_{REFP}$	V
		Internal reference voltage ( $2.4\text{ V} \leq V_{DD} \leq 5.5\text{ V}$ , HS (high-speed main) mode))		$V_{BGR}$ <sup>Note 4</sup>		V
		Temperature sensor output voltage ( $2.4\text{ V} \leq V_{DD} \leq 5.5\text{ V}$ , HS (high-speed main) mode))		$V_{TMPS25}$ <sup>Note 4</sup>		V

(Notes are listed on the next page.)

**Notes** 1. Excludes quantization error ( $\pm 1/2$  LSB).

2. This value is indicated as a ratio (%FSR) to the full-scale value.

3. When  $AV_{\text{REFP}} < V_{\text{DD}}$ , the MAX. values are as follows.

Overall error: Add  $\pm 4$  LSB to the MAX. value when  $AV_{\text{REFP}} = V_{\text{DD}}$ .

Zero-scale error/Full-scale error: Add  $\pm 0.2\%$ FSR to the MAX. value when  $AV_{\text{REFP}} = V_{\text{DD}}$ .

Integral linearity error/ Differential linearity error: Add  $\pm 2$  LSB to the MAX. value when  $AV_{\text{REFP}} = V_{\text{DD}}$ .

4. See 3.6.2 Temperature sensor/internal reference voltage characteristics.

(2) When reference voltage (+) =  $V_{\text{DD}}$  (ADREFP1 = 0, ADREFP0 = 0), reference voltage (-) =  $V_{\text{SS}}$  (ADREFM = 0), target pins: ANI0, ANI1, ANI16 to ANI25, internal reference voltage, and temperature sensor output voltage

( $T_A = -40$  to  $+105^\circ\text{C}$ ,  $2.4\text{ V} \leq V_{\text{DD}} \leq 5.5\text{ V}$ ,  $V_{\text{SS}} = 0\text{ V}$ , Reference voltage (+) =  $V_{\text{DD}}$ , Reference voltage (-) =  $V_{\text{SS}}$ )

Parameter	Symbol	Conditions		MIN.	TYP.	MAX.	Unit
Resolution	RES			8		10	bit
Overall error <sup>Note 1</sup>	AINL	10-bit resolution	$2.4\text{ V} \leq V_{\text{DD}} \leq 5.5\text{ V}$		1.2	$\pm 7.0$	LSB
Conversion time	$t_{\text{CONV}}$	10-bit resolution Target pin: ANI0, ANI1, ANI16 to ANI25	$3.6\text{ V} \leq V_{\text{DD}} \leq 5.5\text{ V}$	2.125		39	$\mu\text{s}$
			$2.7\text{ V} \leq V_{\text{DD}} \leq 5.5\text{ V}$	3.1875		39	$\mu\text{s}$
			$2.4\text{ V} \leq V_{\text{DD}} \leq 5.5\text{ V}$	17		39	$\mu\text{s}$
		10-bit resolution Target pin: Internal reference voltage, and temperature sensor output voltage (HS (high-speed main) mode)	$3.6\text{ V} \leq V_{\text{DD}} \leq 5.5\text{ V}$	2.375		39	$\mu\text{s}$
			$2.7\text{ V} \leq V_{\text{DD}} \leq 5.5\text{ V}$	3.5625		39	$\mu\text{s}$
			$2.4\text{ V} \leq V_{\text{DD}} \leq 5.5\text{ V}$	17		39	$\mu\text{s}$
Zero-scale error <sup>Notes 1, 2</sup>	E <sub>ZS</sub>	10-bit resolution	$2.4\text{ V} \leq V_{\text{DD}} \leq 5.5\text{ V}$			$\pm 0.60$	%FSR
Full-scale error <sup>Notes 1, 2</sup>	E <sub>FS</sub>	10-bit resolution	$2.4\text{ V} \leq V_{\text{DD}} \leq 5.5\text{ V}$			$\pm 0.60$	%FSR
Integral linearity error <sup>Note 1</sup>	ILE	10-bit resolution	$2.4\text{ V} \leq V_{\text{DD}} \leq 5.5\text{ V}$			$\pm 4.0$	LSB
Differential linearity error <sup>Note 1</sup>	DLE	10-bit resolution	$2.4\text{ V} \leq V_{\text{DD}} \leq 5.5\text{ V}$			$\pm 2.0$	LSB
Analog input voltage	$V_{\text{AIN}}$	ANI0, ANI1, ANI16 to ANI25		0		$V_{\text{DD}}$	V
		Internal reference voltage ( $2.4\text{ V} \leq V_{\text{DD}} \leq 5.5\text{ V}$ , HS (high-speed main) mode))			$V_{\text{BGR}}$ <sup>Note 3</sup>		V
		Temperature sensor output voltage ( $2.4\text{ V} \leq V_{\text{DD}} \leq 5.5\text{ V}$ , HS (high-speed main) mode))			$V_{\text{TMPS25}}$ <sup>Note 3</sup>		

**Notes** 1. Excludes quantization error ( $\pm 1/2$  LSB).

2. This value is indicated as a ratio (%FSR) to the full-scale value.

3. See 3.6.2 Temperature sensor/internal reference voltage characteristics.

(3) When reference voltage (+) = internal reference voltage (ADREFP1 = 1, ADREFP0 = 0), reference voltage (-) = AVREFM/ANI1 (ADREFM = 1), target pins: ANI0, ANI16 to ANI25

( $T_A = -40$  to  $+105^\circ\text{C}$ ,  $2.4\text{ V} \leq V_{DD} \leq 5.5\text{ V}$ ,  $V_{SS} = 0\text{ V}$ , Reference voltage (+) =  $V_{BGR}$ <sup>Note 3</sup>,  
Reference voltage (-) =  $AV_{REFM}$ <sup>Note 4</sup> = 0 V, HS (high-speed main) mode)

Parameter	Symbol	Conditions		MIN.	TYP.	MAX.	Unit
Resolution	RES			8			bit
Conversion time	$t_{CONV}$	8-bit resolution	$2.4\text{ V} \leq V_{DD} \leq 5.5\text{ V}$	17		39	$\mu\text{s}$
Zero-scale error <sup>Notes 1, 2</sup>	E <sub>ZS</sub>	8-bit resolution	$2.4\text{ V} \leq V_{DD} \leq 5.5\text{ V}$			$\pm 0.60$	%FSR
Integral linearity error <sup>Note 1</sup>	ILE	8-bit resolution	$2.4\text{ V} \leq V_{DD} \leq 5.5\text{ V}$			$\pm 2.0$	LSB
Differential linearity error <sup>Note 1</sup>	DLE	8-bit resolution	$2.4\text{ V} \leq V_{DD} \leq 5.5\text{ V}$			$\pm 1.0$	LSB
Analog input voltage	$V_{AIN}$			0		$V_{BGR}$ <sup>Note 3</sup>	V

**Notes** 1. Excludes quantization error ( $\pm 1/2$  LSB).

2. This value is indicated as a ratio (%FSR) to the full-scale value.

3. See 3.6.2 Temperature sensor/internal reference voltage characteristics.

4. When reference voltage (-) =  $V_{SS}$ , the MAX. values are as follows.

Zero-scale error: Add  $\pm 0.35\%$ FSR to the  $AV_{REFM}$  MAX. value.

Integral linearity error: Add  $\pm 0.5$  LSB to the  $AV_{REFM}$  MAX. value.

Differential linearity error: Add  $\pm 0.2$  LSB to the  $AV_{REFM}$  MAX. value.

### 3.6.2 Temperature sensor/internal reference voltage characteristics

( $T_A = -40$  to  $+105^\circ\text{C}$ ,  $2.4\text{ V} \leq V_{DD} \leq 5.5\text{ V}$ ,  $V_{SS} = 0\text{ V}$ , HS (high-speed main) mode)

Parameter	Symbol	Conditions	MIN.	TYP.	MAX.	Unit
Temperature sensor output voltage	$V_{TMPS25}$	ADS register = 80H, $T_A = +25^\circ\text{C}$		1.05		V
Internal reference output voltage	$V_{BGR}$	ADS register = 81H	1.38	1.45	1.5	V
Temperature coefficient	$F_{VTMPS}$	Temperature sensor that depends on the temperature		-3.6		mV/ $^\circ\text{C}$
Operation stabilization wait time	$t_{AMP}$				5	$\mu\text{s}$



## 3.6.3 Comparator

 $(T_A = -40$  to  $+105^\circ\text{C}$ ,  $2.4\text{ V} \leq V_{DD} \leq 5.5\text{ V}$ ,  $V_{SS} = 0\text{ V}$ )

Parameter	Symbol	Conditions	MIN.	TYP.	MAX.	Unit
Input voltage range	Ivref		0		$V_{DD} - 1.4$	V
	Ivcmp		-0.3		$V_{DD} + 0.3$	V
Output delay	td	$V_{DD} = 3.0\text{ V}$ Input slew rate $> 50\text{ mV}/\mu\text{s}$	Comparator high-speed mode, standard mode		1.2	$\mu\text{s}$
			Comparator high-speed mode, window mode		2.0	$\mu\text{s}$
			Comparator low-speed mode, standard mode		3.0	5.0
High-electric-potential reference voltage	VTW+	Comparator high-speed mode, window mode	$0.66V_{DD}$	$0.76V_{DD}$	$0.86V_{DD}$	V
Low-electric-potential reference voltage	VTW-	Comparator high-speed mode, window mode	$0.14V_{DD}$	$0.24V_{DD}$	$0.34V_{DD}$	V
Operation stabilization wait time	tCMP		100			$\mu\text{s}$
Internal reference output voltage <sup>Note</sup>	V <sub>BGR</sub>	$2.4\text{ V} \leq V_{DD} \leq 5.5\text{ V}$ , HS (high-speed main) mode	1.38	1.45	1.50	V

**Note** Cannot be used in subsystem clock operation and STOP mode.

## 3.6.4 POR circuit characteristics

 $(T_A = -40$  to  $+105^\circ\text{C}$ ,  $V_{SS} = 0\text{ V}$ )

Parameter	Symbol	Conditions	MIN.	TYP.	MAX.	Unit
Detection voltage	V <sub>POR</sub>	When power supply rises	1.45	1.51	1.57	V
	V <sub>PDR</sub>	When power supply falls	1.44	1.50	1.56	V
Minimum pulse width <sup>Note</sup>	T <sub>PW</sub>		300			$\mu\text{s}$

**Note** This is the time required for the POR circuit to execute a reset operation when  $V_{DD}$  falls below  $V_{PDR}$ . When the microcontroller enters STOP mode and when the main system clock ( $f_{\text{MAIN}}$ ) has been stopped by setting bit 0 (HIOSTOP) and bit 7 (MSTOP) of the clock operation status control register (CSC), this is the time required for the POR circuit to execute a reset operation between when  $V_{DD}$  falls below  $0.7\text{ V}$  and when  $V_{DD}$  rises to  $V_{POR}$  or higher.

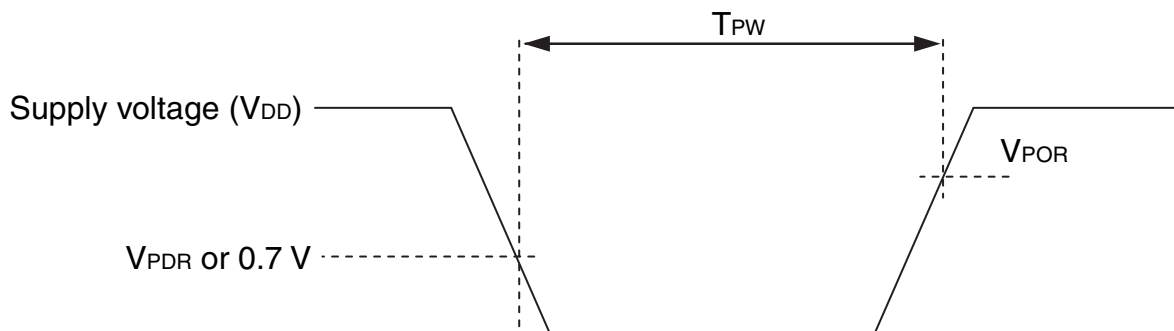

## 3.6.5 LVD circuit characteristics

**LVD Detection Voltage of Reset Mode and Interrupt Mode** $(T_A = -40$  to  $+105^\circ\text{C}$ ,  $V_{PDR} \leq V_{DD} \leq 5.5$  V,  $V_{SS} = 0$  V)

Parameter		Symbol	Conditions	MIN.	TYP.	MAX.	Unit
Detection voltage	Supply voltage level	$V_{LVD0}$	When power supply rises	3.90	4.06	4.22	V
			When power supply falls	3.83	3.98	4.13	V
		$V_{LVD1}$	When power supply rises	3.60	3.75	3.90	V
			When power supply falls	3.53	3.67	3.81	V
		$V_{LVD2}$	When power supply rises	3.01	3.13	3.25	V
			When power supply falls	2.94	3.06	3.18	V
		$V_{LVD3}$	When power supply rises	2.90	3.02	3.14	V
			When power supply falls	2.85	2.96	3.07	V
		$V_{LVD4}$	When power supply rises	2.81	2.92	3.03	V
			When power supply falls	2.75	2.86	2.97	V
		$V_{LVD5}$	When power supply rises	2.71	2.81	2.92	V
			When power supply falls	2.64	2.75	2.86	V
		$V_{LVD6}$	When power supply rises	2.61	2.71	2.81	V
			When power supply falls	2.55	2.65	2.75	V
		$V_{LVD7}$	When power supply rises	2.51	2.61	2.71	V
			When power supply falls	2.45	2.55	2.65	V
Minimum pulse width		$t_{LW}$		300			$\mu\text{s}$
Detection delay time						300	$\mu\text{s}$

**LVD Detection Voltage of Interrupt & Reset Mode** $(T_A = -40$  to  $+105^\circ\text{C}$ ,  $V_{PDR} \leq V_{DD} \leq 5.5$  V,  $V_{SS} = 0$  V)

Parameter	Symbol	Conditions	MIN.	TYP.	MAX.	Unit	
Interrupt and reset mode	$V_{LVD5}$	$V_{POC2}, V_{POC1}, V_{POC0} = 0, 1, 1$ , falling reset voltage	2.64	2.75	2.86	V	
	$V_{LVD4}$	LVIS1, LVIS0 = 1, 0	Rising release reset voltage	2.81	2.92	3.03	V
			Falling interrupt voltage	2.75	2.86	2.97	V
	$V_{LVD3}$	LVIS1, LVIS0 = 0, 1	Rising release reset voltage	2.90	3.02	3.14	V
			Falling interrupt voltage	2.85	2.96	3.07	V
	$V_{LVD0}$	LVIS1, LVIS0 = 0, 0	Rising release reset voltage	3.90	4.06	4.22	V
Falling interrupt voltage			3.83	3.98	4.13	V	

## 3.6.6 Supply voltage rise time

 $(T_A = -40$  to  $+105^\circ\text{C}$ ,  $V_{SS} = 0$  V)

Parameter	Symbol	Conditions	MIN.	TYP.	MAX.	Unit
$V_{DD}$ rise slope	$SV_{DD}$				54	V/ms

**Caution** Make sure to keep the internal reset state by the LVD circuit or an external reset until  $V_{DD}$  reaches the operating voltage range shown in 3.4 AC Characteristics.

## 3.7 LCD Characteristics

## 3.7.1 External resistance division method

## (1) Static display mode

 $(T_A = -40$  to  $+105^\circ\text{C}$ ,  $V_{L4} (\text{MIN.}) \leq V_{DD} \leq 5.5 \text{ V}$ ,  $V_{SS} = 0 \text{ V}$ )

Parameter	Symbol	Conditions	MIN.	TYP.	MAX.	Unit
LCD drive voltage	$V_{L4}$		2.0		$V_{DD}$	V

## (2) 1/2 bias method, 1/4 bias method

 $(T_A = -40$  to  $+105^\circ\text{C}$ ,  $V_{L4} (\text{MIN.}) \leq V_{DD} \leq 5.5 \text{ V}$ ,  $V_{SS} = 0 \text{ V}$ )

Parameter	Symbol	Conditions	MIN.	TYP.	MAX.	Unit
LCD drive voltage	$V_{L4}$		2.7		$V_{DD}$	V

## (3) 1/3 bias method

 $(T_A = -40$  to  $+105^\circ\text{C}$ ,  $V_{L4} (\text{MIN.}) \leq V_{DD} \leq 5.5 \text{ V}$ ,  $V_{SS} = 0 \text{ V}$ )

Parameter	Symbol	Conditions	MIN.	TYP.	MAX.	Unit
LCD drive voltage	$V_{L4}$		2.5		$V_{DD}$	V

## 3.7.2 Internal voltage boosting method

## (1) 1/3 bias method

 $(T_A = -40$  to  $+105^\circ\text{C}$ ,  $2.4\text{ V} \leq V_{DD} \leq 5.5\text{ V}$ ,  $V_{SS} = 0\text{ V})$ 

Parameter	Symbol	Conditions	MIN.	TYP.	MAX.	Unit	
LCD output voltage variation range	$V_{L1}$	C1 to C4 <sup>Note 1</sup> = $0.47\ \mu\text{F}$ <sup>Note 2</sup>	VLCD = 04H	0.90	1.00	1.08	V
			VLCD = 05H	0.95	1.05	1.13	V
			VLCD = 06H	1.00	1.10	1.18	V
			VLCD = 07H	1.05	1.15	1.23	V
			VLCD = 08H	1.10	1.20	1.28	V
			VLCD = 09H	1.15	1.25	1.33	V
			VLCD = 0AH	1.20	1.30	1.38	V
			VLCD = 0BH	1.25	1.35	1.43	V
			VLCD = 0CH	1.30	1.40	1.48	V
			VLCD = 0DH	1.35	1.45	1.53	V
			VLCD = 0EH	1.40	1.50	1.58	V
			VLCD = 0FH	1.45	1.55	1.63	V
			VLCD = 10H	1.50	1.60	1.68	V
			VLCD = 11H	1.55	1.65	1.73	V
VLCD = 12H	1.60	1.70	1.78	V			
VLCD = 13H	1.65	1.75	1.83	V			
Doubler output voltage	$V_{L2}$	C1 to C4 <sup>Note 1</sup> = $0.47\ \mu\text{F}$	$2 V_{L1} - 0.10$	$2 V_{L1}$	$2 V_{L1}$	V	
Tripler output voltage	$V_{L4}$	C1 to C4 <sup>Note 1</sup> = $0.47\ \mu\text{F}$	$3 V_{L1} - 0.15$	$3 V_{L1}$	$3 V_{L1}$	V	
Reference voltage setup time <sup>Note 2</sup>	$t_{\text{WAIT1}}$		5			ms	
Voltage boost wait time <sup>Note 3</sup>	$t_{\text{WAIT2}}$	C1 to C4 <sup>Note 1</sup> = $0.47\ \mu\text{F}$	500			ms	

**Notes** 1. This is a capacitor that is connected between voltage pins used to drive the LCD.

C1: A capacitor connected between CAPH and CAPL

C2: A capacitor connected between  $V_{L1}$  and GND

C3: A capacitor connected between  $V_{L2}$  and GND

C4: A capacitor connected between  $V_{L4}$  and GND

$C1 = C2 = C3 = C4 = 0.47\ \mu\text{F} \pm 30\%$

- This is the time required to wait from when the reference voltage is specified by using the VLCD register (or when the internal voltage boosting method is selected (by setting the MDSET1 and MDSET0 bits of the LCDM0 register to 01B) if the default value reference voltage is used) until voltage boosting starts (VLCON = 1).
- This is the wait time from when voltage boosting is started (VLCON = 1) until display is enabled (LCDON = 1).

**(2) 1/4 bias method****( $T_A = -40$  to  $+105^\circ\text{C}$ ,  $2.4\text{ V} \leq V_{DD} \leq 5.5\text{ V}$ ,  $V_{SS} = 0\text{ V}$ )**

Parameter	Symbol	Conditions	MIN.	TYP.	MAX.	Unit	
LCD output voltage variation range	$V_{L1}$	C1 to C5 <sup>Note 1</sup> = $0.47\ \mu\text{F}$ <sup>Note 2</sup>	VLCD = 04H	0.90	1.00	1.08	V
			VLCD = 05H	0.95	1.05	1.13	V
			VLCD = 06H	1.00	1.10	1.18	V
			VLCD = 07H	1.05	1.15	1.23	V
			VLCD = 08H	1.10	1.20	1.28	V
			VLCD = 09H	1.15	1.25	1.33	V
			VLCD = 0AH	1.20	1.30	1.38	V
Doubler output voltage	$V_{L2}$	C1 to C5 <sup>Note 1</sup> = $0.47\ \mu\text{F}$	$2 V_{L1} - 0.08$	$2 V_{L1}$	$2 V_{L1}$	V	
Tripler output voltage	$V_{L3}$	C1 to C5 <sup>Note 1</sup> = $0.47\ \mu\text{F}$	$3 V_{L1} - 0.12$	$3 V_{L1}$	$3 V_{L1}$	V	
Quadruply output voltage	$V_{L4}$	C1 to C5 <sup>Note 1</sup> = $0.47\ \mu\text{F}$	$4 V_{L1} - 0.16$	$4 V_{L1}$	$4 V_{L1}$	V	
Reference voltage setup time <sup>Note 2</sup>	$t_{\text{WAIT1}}$		5			ms	
Voltage boost wait time <sup>Note 3</sup>	$t_{\text{WAIT2}}$	C1 to C5 <sup>Note 1</sup> = $0.47\ \mu\text{F}$	500			ms	

**Notes** 1. This is a capacitor that is connected between voltage pins used to drive the LCD.

C1: A capacitor connected between CAPH and CAPL

C2: A capacitor connected between  $V_{L1}$  and GND

C3: A capacitor connected between  $V_{L2}$  and GND

C4: A capacitor connected between  $V_{L3}$  and GND

C5: A capacitor connected between  $V_{L4}$  and GND

$C1 = C2 = C3 = C4 = C5 = 0.47\ \mu\text{F} \pm 30\%$

2. This is the time required to wait from when the reference voltage is specified by using the VLCD register (or when the internal voltage boosting method is selected (by setting the MDSET1 and MDSET0 bits of the LCDM0 register to 01B) if the default value reference voltage is used) until voltage boosting starts (VLCON = 1).

3. This is the wait time from when voltage boosting is started (VLCON = 1) until display is enabled (LCDON = 1).

## 3.7.3 Capacitor split method

**(1) 1/3 bias method****( $T_A = -40$  to  $+105^\circ\text{C}$ ,  $2.4\text{ V} \leq V_D \leq 5.5\text{ V}$ ,  $V_{SS} = 0\text{ V}$ )**

Parameter	Symbol	Conditions	MIN.	TYP.	MAX.	Unit
$V_{L4}$ voltage	$V_{L4}$	C1 to C4 = $0.47\ \mu\text{F}$ <sup>Note 2</sup>		$V_{DD}$		V
$V_{L2}$ voltage	$V_{L2}$	C1 to C4 = $0.47\ \mu\text{F}$ <sup>Note 2</sup>	$\frac{2}{3} V_{L4} - 0.1$	$\frac{2}{3} V_{L4}$	$\frac{2}{3} V_{L4} + 0.1$	V
$V_{L1}$ voltage	$V_{L1}$	C1 to C4 = $0.47\ \mu\text{F}$ <sup>Note 2</sup>	$\frac{1}{3} V_{L4} - 0.1$	$\frac{1}{3} V_{L4}$	$\frac{1}{3} V_{L4} + 0.1$	V
Capacitor split wait time <sup>Note 1</sup>	$t_{\text{WAIT}}$		100			ms

**Notes** 1. This is the wait time from when voltage bucking is started (VLCON = 1) until display is enabled (LCDON = 1).

2. This is a capacitor that is connected between voltage pins used to drive the LCD.

C1: A capacitor connected between CAPH and CAPL

C2: A capacitor connected between  $V_{L1}$  and GND

C3: A capacitor connected between  $V_{L2}$  and GND

C4: A capacitor connected between  $V_{L4}$  and GND

$C1 = C2 = C3 = C4 = 0.47\ \mu\text{F} \pm 30\%$

### 3.8 RAM Data Retention Characteristics

<R>

( $T_A = -40$  to  $+105^\circ\text{C}$ )

Parameter	Symbol	Conditions	MIN.	TYP.	MAX.	Unit
Data retention supply voltage	$V_{DDDR}$		1.44 <sup>Note</sup>		5.5	V

<R> **Note** This depends on the POR detection voltage. For a falling voltage, data in RAM are retained until the voltage reaches the level that triggers a POR reset but not once it reaches the level at which a POR reset is generated.

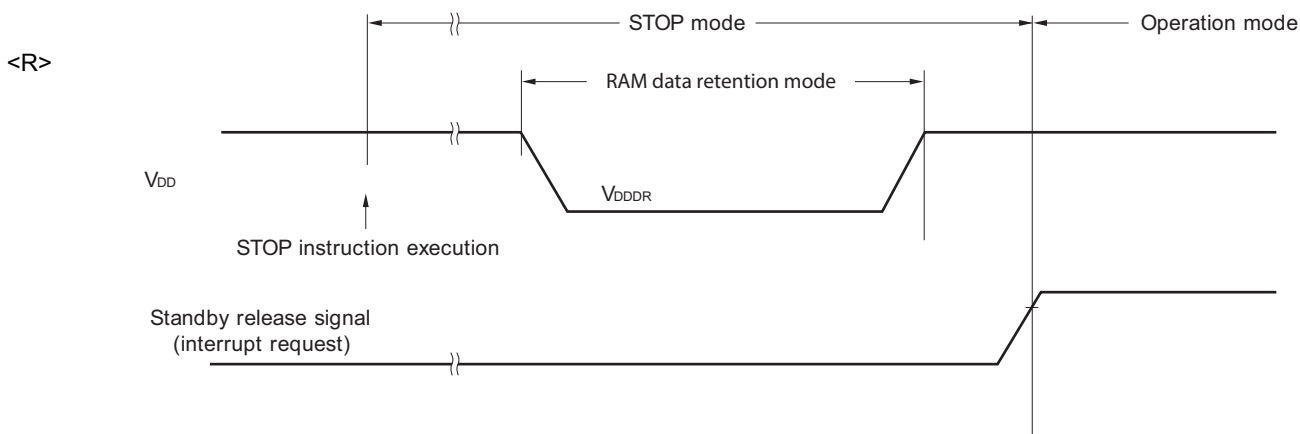

### 3.9 Flash Memory Programming Characteristics

( $T_A = -40$  to  $+105^\circ\text{C}$ ,  $2.4\text{ V} \leq V_{DD} \leq 5.5\text{ V}$ ,  $V_{SS} = 0\text{ V}$ )

Parameter	Symbol	Conditions	MIN.	TYP.	MAX.	Unit
System clock frequency	$f_{CLK}$	$2.4\text{ V} \leq V_{DD} \leq 5.5\text{ V}$	1		24	MHz
Number of code flash rewrites <sup>Note 1, 2, 3</sup>	$C_{erwr}$	Retained for 20 years $T_A = 85^\circ\text{C}$ <sup>Note 4</sup>	1,000			Times
Number of data flash rewrites <sup>Note 1, 2, 3</sup>		Retained for 1 year $T_A = 25^\circ\text{C}$		1,000,000		
		Retained for 5 years $T_A = 85^\circ\text{C}$ <sup>Note 4</sup>	100,000			
		Retained for 20 years $T_A = 85^\circ\text{C}$ <sup>Note 4</sup>	10,000			

- Notes**
1. 1 erase + 1 write after the erase is regarded as 1 rewrite. The retaining years are until next rewrite after the rewrite.
  2. When using flash memory programmer and Renesas Electronics self programming library
  3. This characteristic indicates the flash memory characteristic and based on Renesas Electronics reliability test.
  4. This temperature is the average value at which data are retained.

**Remark** When updating data multiple times, use the flash memory as one for updating data.

### 3.10 Dedicated Flash Memory Programmer Communication (UART)

( $T_A = -40$  to  $+105^\circ\text{C}$ ,  $2.4\text{ V} \leq V_{DD} \leq 5.5\text{ V}$ ,  $V_{SS} = 0\text{ V}$ )

Parameter	Symbol	Conditions	MIN.	TYP.	MAX.	Unit
Transfer rate		During serial programming	115,200		1,000,000	bps

### 3.11 Timing Specifications for Switching Flash Memory Programming Modes

( $T_A = -40$  to  $+105^\circ\text{C}$ ,  $2.4\text{ V} \leq V_{DD} \leq 5.5\text{ V}$ ,  $V_{SS} = 0\text{ V}$ )

Parameter	Symbol	Conditions	MIN.	TYP.	MAX.	Unit
Time to complete the communication for the initial setting after the external reset is released	$t_{\text{SUNIT}}$	POR and LVD reset must be released before the external reset is released.			100	ms
Time to release the external reset after the TOOL0 pin is set to the low level	$t_{\text{SU}}$	POR and LVD reset must be released before the external reset is released.	10			$\mu\text{s}$
Time to hold the TOOL0 pin at the low level after the external reset is released (excluding the processing time of the firmware to control the flash memory)	$t_{\text{HD}}$	POR and LVD reset must be released before the external reset is released.	1			ms

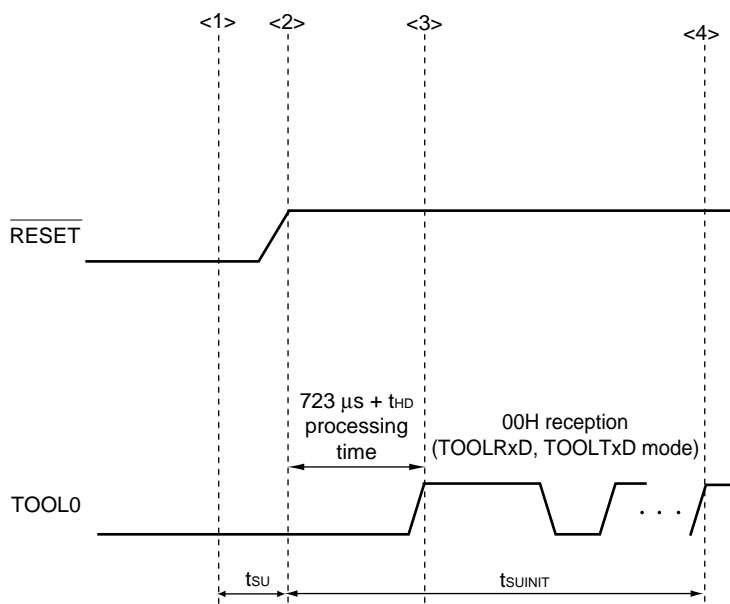

- <1> The low level is input to the TOOL0 pin.
- <2> The external reset is released (POR and LVD reset must be released before the external reset is released.).
- <3> The TOOL0 pin is set to the high level.
- <4> Setting of the flash memory programming mode by UART reception and completion the baud rate setting.

**Remark**  $t_{\text{SUNIT}}$ : Communication for the initial setting must be completed within 100 ms after the external reset is released during this period.

$t_{\text{SU}}$ : Time to release the external reset after the TOOL0 pin is set to the low level

$t_{\text{HD}}$ : Time to hold the TOOL0 pin at the low level after the external reset is released (excluding the processing time of the firmware to control the flash memory)

### 4. PACKAGE DRAWINGS

#### 4.1 64-pin Products

R5F10WLAFA, R5F10WLCAFA, R5F10WLDAFA, R5F10WLEAFA, R5F10WLFafa, R5F10WLGafa

JEITA Package Code	RENESAS Code	Previous Code	MASS (TYP.) [g]
P-LQFP64-12x12-0.65	PLQP0064JA-A	P64GK-65-UET-2	0.51

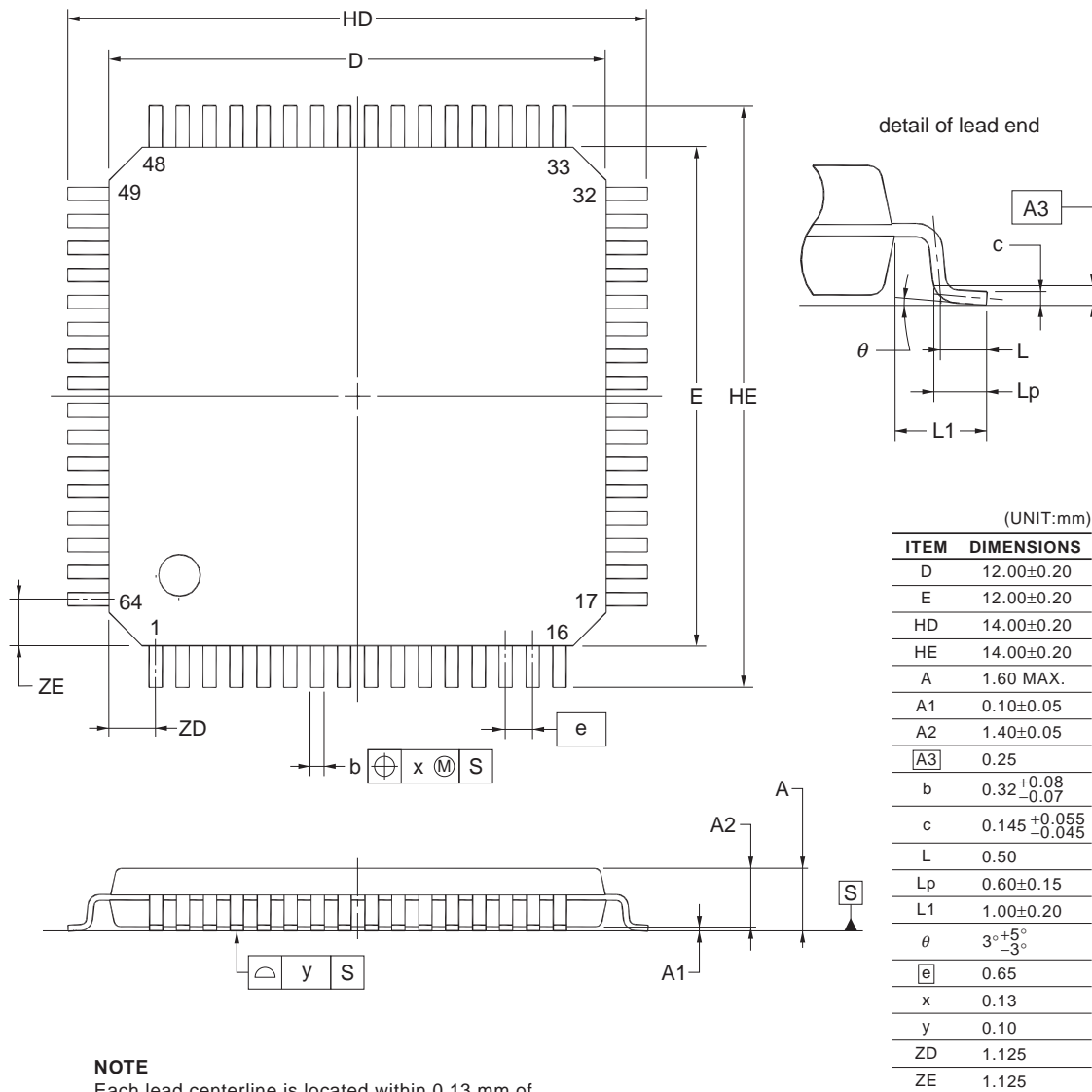

**NOTE**  
Each lead centerline is located within 0.13 mm of its true position at maximum material condition.

©2012 Renesas Electronics Corporation. All rights reserved.



R5F10WLAAFB, R5F10WLCAFB, R5F10WLDAFB, R5F10WLEAFB, R5F10WLFafb, R5F10WLGafb, R5F10WLAGfb, R5F10WLCGfb, R5F10WLDGfb, R5F10WLEgfb, R5F10WLFgfb, R5F10WLGgfb

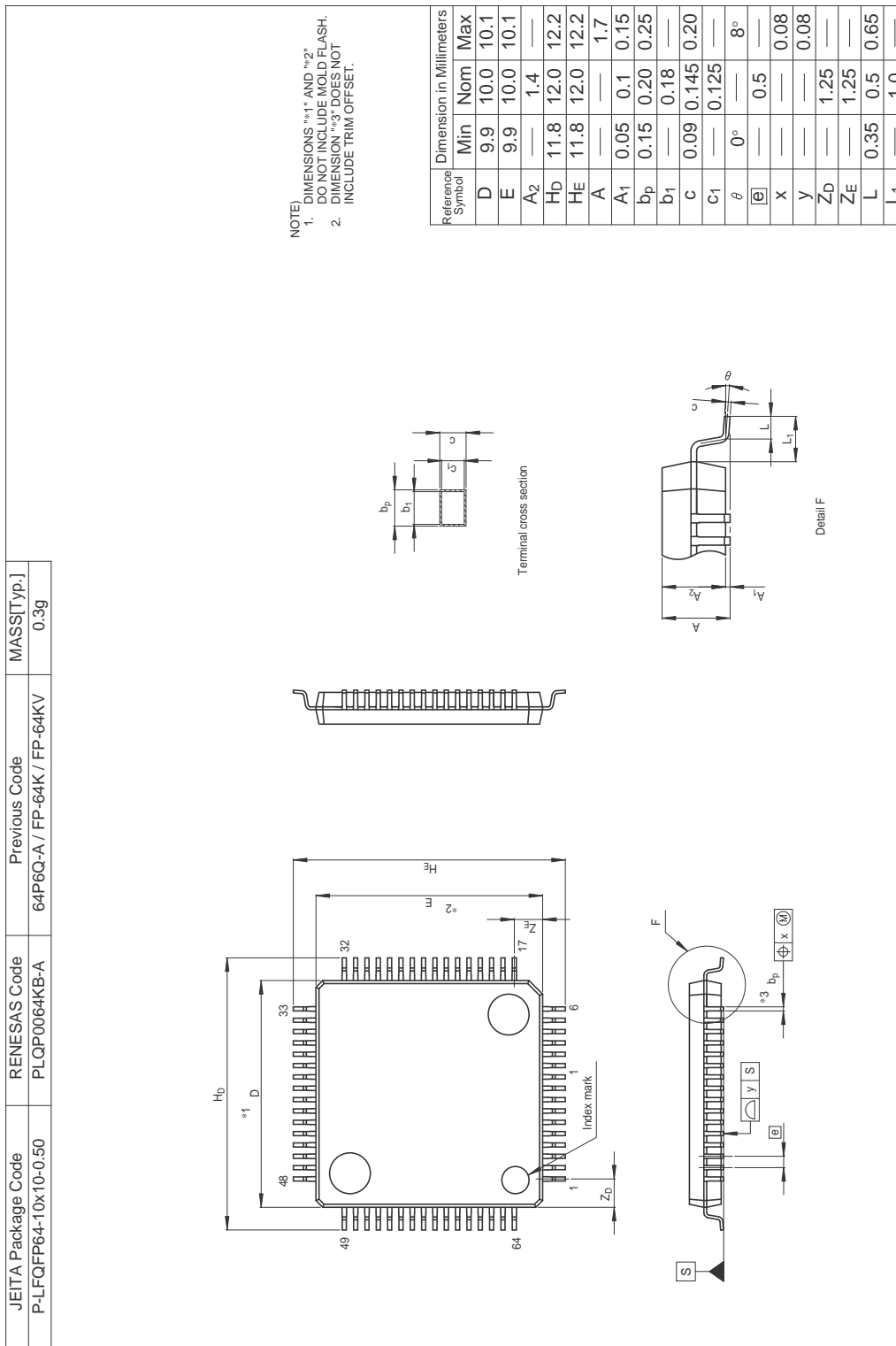

4.2 80-pin Products

R5F10WMAAFA, R5F10WMCAFA, R5F10WMDAFA, R5F10WMEAFA, R5F10WMFAFA, R5F10WMGAFA

JEITA Package Code	RENESAS Code	Previous Code	MASS (TYP.) [g]
P-LQFP80-14x14-0.65	PLQP0080JB-E	P80GC-65-UBT-2	0.69

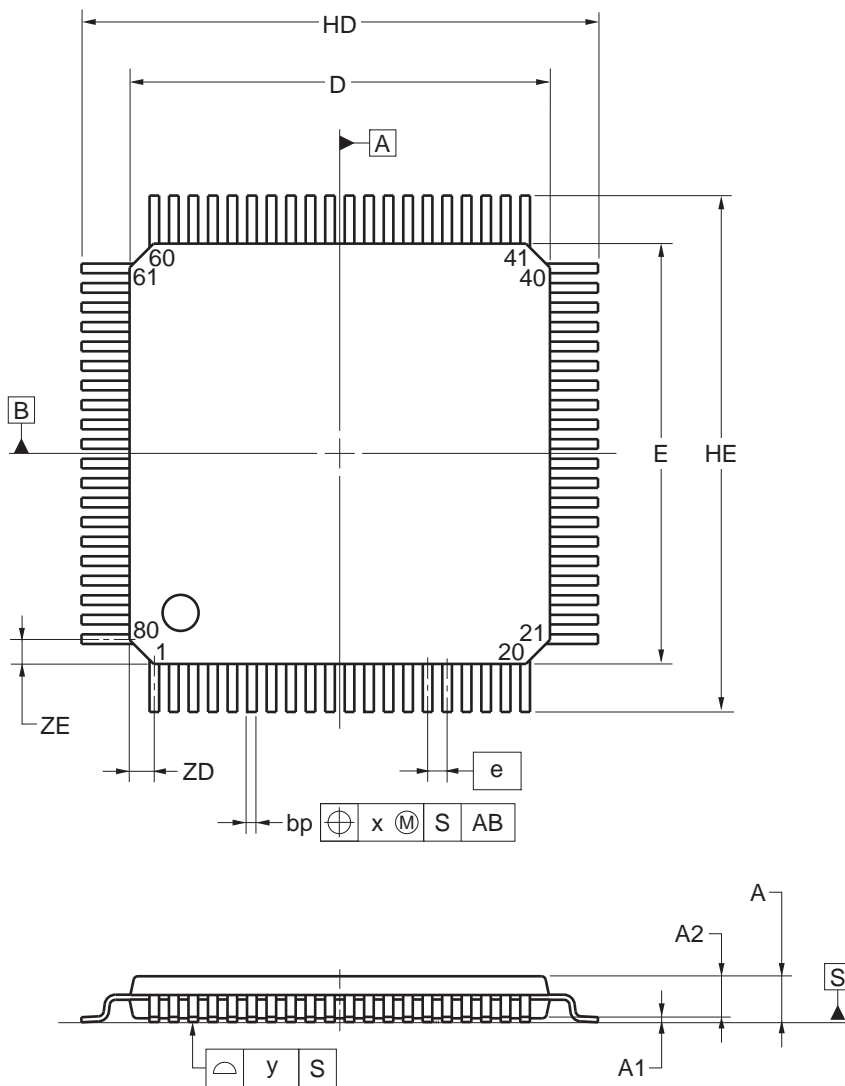

Reference Symbol	Dimension in Millimeters		
	Min	Nom	Max
D	13.80	14.00	14.20
E	13.80	14.00	14.20
HD	17.00	17.20	17.40
HE	17.00	17.20	17.40
A	—	—	1.70
A1	0.05	0.125	0.20
A2	1.35	1.40	1.45
A3	—	0.25	—
bp	0.26	0.32	0.38
c	0.10	0.145	0.20
L	—	0.80	—
Lp	0.736	0.886	1.036
L1	1.40	1.60	1.80
	0°	3°	8°
e	—	0.65	—
x	—	—	0.13
y	—	—	0.10
ZD	—	0.825	—
ZE	—	0.825	—

R5F10WMAAFB, R5F10WMCAFB, R5F10WMDAFB, R5F10WMEAFB, R5F10WMFAFB, R5F10WMGAFB,  
 R5F10WMAGFB, R5F10WMCGB, R5F10WMDGFB, R5F10WMEGFB, R5F10WMFGFB, R5F10WMGGFB

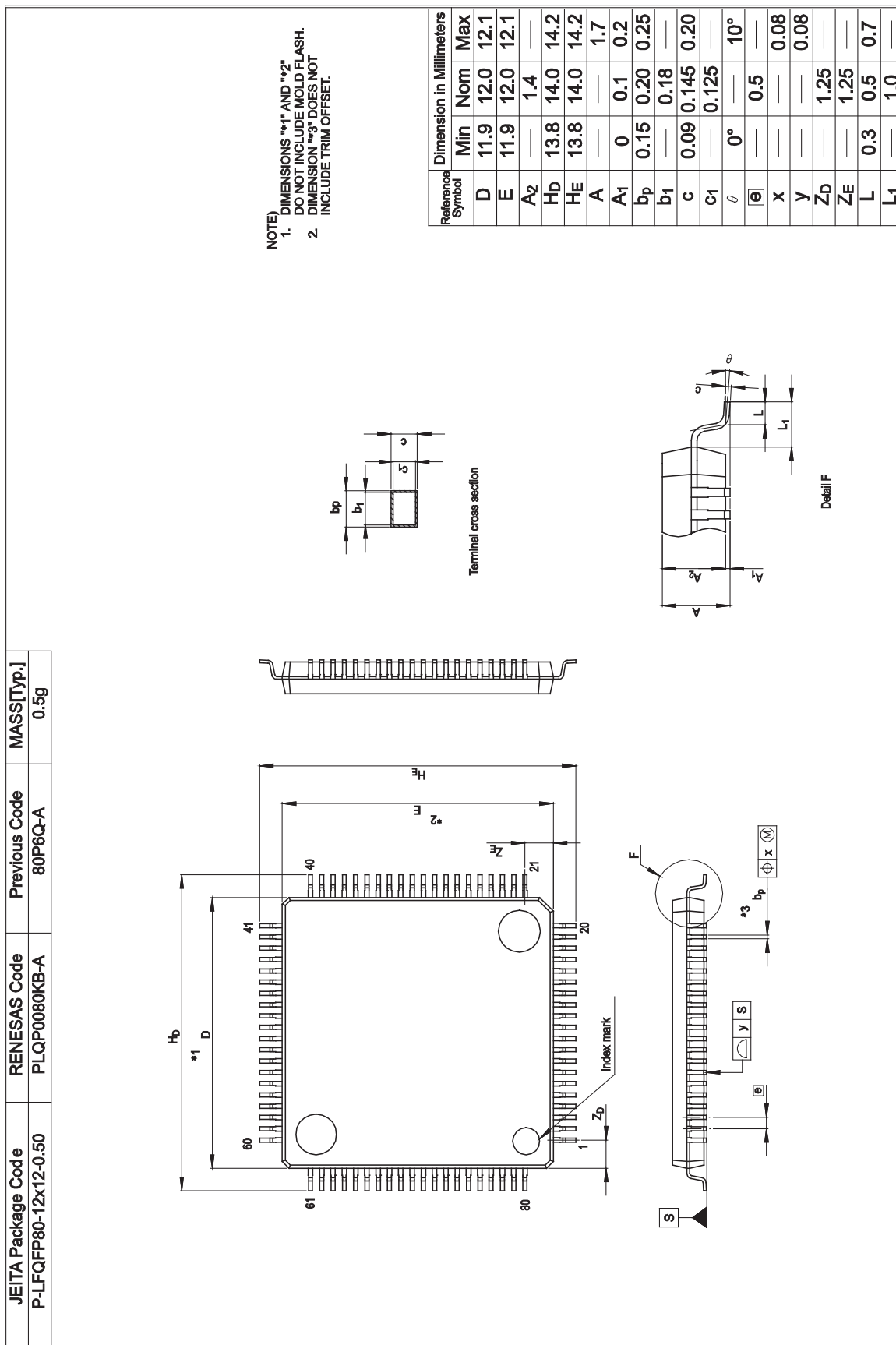

<b>Revision History</b>	<b>RL78/L13 Data Sheet</b>
-------------------------	----------------------------

Rev.	Date	Description	
		Page	Summary
0.01	Apr 13, 2012	-	First Edition issued
0.02	Oct 31, 2012	-	Change of the number of segment pins <ul style="list-style-type: none"> <li>• 64-pin products: 36 pins</li> <li>• 80-pin products: 51 pins</li> </ul>
2.10	Aug 12, 2016	1	Modification of features of 16-bit timer and 16-bit timer KB20 (IH) in 1.1 Features
		5	Addition of product name (RL78/L13) and description (Top View) in 1.3.1 64-pin products
		6	Addition of product name (RL78/L13) and description (Top View) in 1.3.2 80-pin products
		10	Modification of functional overview of main system clock in 1.6 Outline of Functions
		15	Modification of description in Absolute Maximum Ratings (3/3)
		17, 18	Modification of description in 2.3.1 Pin characteristics
		38	Modification of remark 3 in 2.5.1 (4) During communication at same potential (simplified I <sup>2</sup> C mode)
		68	Modification of the title and note, and addition of caution in 2.8 RAM Data Retention Characteristics
		70	Addition of Remark
		74	Modification of description in Absolute Maximum Ratings (T <sub>A</sub> = 25 °C) (3/3)
		76	Modification of description in 3.3.1 Pin characteristics
		95	Modification of remark 3 in 3.5.1 (4) During communication at same potential (simplified I <sup>2</sup> C mode)
118	Modification of the title and note, and addition of caution in 3.8 RAM Data Retention Characteristics		

All trademarks and registered trademarks are the property of their respective owners.

SuperFlash is a registered trademark of Silicon Storage Technology, Inc. in several countries including the United States and Japan.

Caution: This product uses SuperFlash<sup>®</sup> technology licensed from Silicon Storage Technology, Inc.

## NOTES FOR CMOS DEVICES

- (1) **VOLTAGE APPLICATION WAVEFORM AT INPUT PIN:** Waveform distortion due to input noise or a reflected wave may cause malfunction. If the input of the CMOS device stays in the area between  $V_{IL}$  (MAX) and  $V_{IH}$  (MIN) due to noise, etc., the device may malfunction. Take care to prevent chattering noise from entering the device when the input level is fixed, and also in the transition period when the input level passes through the area between  $V_{IL}$  (MAX) and  $V_{IH}$  (MIN).
- (2) **HANDLING OF UNUSED INPUT PINS:** Unconnected CMOS device inputs can be cause of malfunction. If an input pin is unconnected, it is possible that an internal input level may be generated due to noise, etc., causing malfunction. CMOS devices behave differently than Bipolar or NMOS devices. Input levels of CMOS devices must be fixed high or low by using pull-up or pull-down circuitry. Each unused pin should be connected to VDD or GND via a resistor if there is a possibility that it will be an output pin. All handling related to unused pins must be judged separately for each device and according to related specifications governing the device.
- (3) **PRECAUTION AGAINST ESD:** A strong electric field, when exposed to a MOS device, can cause destruction of the gate oxide and ultimately degrade the device operation. Steps must be taken to stop generation of static electricity as much as possible, and quickly dissipate it when it has occurred. Environmental control must be adequate. When it is dry, a humidifier should be used. It is recommended to avoid using insulators that easily build up static electricity. Semiconductor devices must be stored and transported in an anti-static container, static shielding bag or conductive material. All test and measurement tools including work benches and floors should be grounded. The operator should be grounded using a wrist strap. Semiconductor devices must not be touched with bare hands. Similar precautions need to be taken for PW boards with mounted semiconductor devices.
- (4) **STATUS BEFORE INITIALIZATION:** Power-on does not necessarily define the initial status of a MOS device. Immediately after the power source is turned ON, devices with reset functions have not yet been initialized. Hence, power-on does not guarantee output pin levels, I/O settings or contents of registers. A device is not initialized until the reset signal is received. A reset operation must be executed immediately after power-on for devices with reset functions.
- (5) **POWER ON/OFF SEQUENCE:** In the case of a device that uses different power supplies for the internal operation and external interface, as a rule, switch on the external power supply after switching on the internal power supply. When switching the power supply off, as a rule, switch off the external power supply and then the internal power supply. Use of the reverse power on/off sequences may result in the application of an overvoltage to the internal elements of the device, causing malfunction and degradation of internal elements due to the passage of an abnormal current. The correct power on/off sequence must be judged separately for each device and according to related specifications governing the device.
- (6) **INPUT OF SIGNAL DURING POWER OFF STATE :** Do not input signals or an I/O pull-up power supply while the device is not powered. The current injection that results from input of such a signal or I/O pull-up power supply may cause malfunction and the abnormal current that passes in the device at this time may cause degradation of internal elements. Input of signals during the power off state must be judged separately for each device and according to related specifications governing the device.

## Notice

1. Descriptions of circuits, software and other related information in this document are provided only to illustrate the operation of semiconductor products and application examples. You are fully responsible for the incorporation of these circuits, software, and information in the design of your equipment. Renesas Electronics assumes no responsibility for any losses incurred by you or third parties arising from the use of these circuits, software, or information.
2. Renesas Electronics has used reasonable care in preparing the information included in this document, but Renesas Electronics does not warrant that such information is error free. Renesas Electronics assumes no liability whatsoever for any damages incurred by you resulting from errors in or omissions from the information included herein.
3. Renesas Electronics does not assume any liability for infringement of patents, copyrights, or other intellectual property rights of third parties by or arising from the use of Renesas Electronics products or technical information described in this document. No license, express, implied or otherwise, is granted hereby under any patents, copyrights or other intellectual property rights of Renesas Electronics or others.
4. You should not alter, modify, copy, or otherwise misappropriate any Renesas Electronics product, whether in whole or in part. Renesas Electronics assumes no responsibility for any losses incurred by you or third parties arising from such alteration, modification, copy or otherwise misappropriation of Renesas Electronics product.
5. Renesas Electronics products are classified according to the following two quality grades: "Standard" and "High Quality". The recommended applications for each Renesas Electronics product depends on the product's quality grade, as indicated below.  
"Standard": Computers; office equipment; communications equipment; test and measurement equipment; audio and visual equipment; home electronic appliances; machine tools; personal electronic equipment; and industrial robots etc.  
"High Quality": Transportation equipment (automobiles, trains, ships, etc.); traffic control systems; anti-disaster systems; anti-crime systems; and safety equipment etc.  
Renesas Electronics products are neither intended nor authorized for use in products or systems that may pose a direct threat to human life or bodily injury (artificial life support devices or systems, surgical implantations etc.), or may cause serious property damages (nuclear reactor control systems, military equipment etc.). You must check the quality grade of each Renesas Electronics product before using it in a particular application. You may not use any Renesas Electronics product for any application for which it is not intended. Renesas Electronics shall not be in any way liable for any damages or losses incurred by you or third parties arising from the use of any Renesas Electronics product for which the product is not intended by Renesas Electronics.
6. You should use the Renesas Electronics products described in this document within the range specified by Renesas Electronics, especially with respect to the maximum rating, operating supply voltage range, movement power voltage range, heat radiation characteristics, installation and other product characteristics. Renesas Electronics shall have no liability for malfunctions or damages arising out of the use of Renesas Electronics products beyond such specified ranges.
7. Although Renesas Electronics endeavors to improve the quality and reliability of its products, semiconductor products have specific characteristics such as the occurrence of failure at a certain rate and malfunctions under certain use conditions. Further, Renesas Electronics products are not subject to radiation resistance design. Please be sure to implement safety measures to guard them against the possibility of physical injury, and injury or damage caused by fire in the event of the failure of a Renesas Electronics product, such as safety design for hardware and software including but not limited to redundancy, fire control and malfunction prevention, appropriate treatment for aging degradation or any other appropriate measures. Because the evaluation of microcomputer software alone is very difficult, please evaluate the safety of the final products or systems manufactured by you.
8. Please contact a Renesas Electronics sales office for details as to environmental matters such as the environmental compatibility of each Renesas Electronics product. Please use Renesas Electronics products in compliance with all applicable laws and regulations that regulate the inclusion or use of controlled substances, including without limitation, the EU RoHS Directive. Renesas Electronics assumes no liability for damages or losses occurring as a result of your noncompliance with applicable laws and regulations.
9. Renesas Electronics products and technology may not be used for or incorporated into any products or systems whose manufacture, use, or sale is prohibited under any applicable domestic or foreign laws or regulations. You should not use Renesas Electronics products or technology described in this document for any purpose relating to military applications or use by the military, including but not limited to the development of weapons of mass destruction. When exporting the Renesas Electronics products or technology described in this document, you should comply with the applicable export control laws and regulations and follow the procedures required by such laws and regulations.
10. It is the responsibility of the buyer or distributor of Renesas Electronics products, who distributes, disposes of, or otherwise places the product with a third party, to notify such third party in advance of the contents and conditions set forth in this document, Renesas Electronics assumes no responsibility for any losses incurred by you or third parties as a result of unauthorized use of Renesas Electronics products.
11. This document may not be reproduced or duplicated in any form, in whole or in part, without prior written consent of Renesas Electronics.
12. Please contact a Renesas Electronics sales office if you have any questions regarding the information contained in this document or Renesas Electronics products, or if you have any other inquiries.

(Note 1) "Renesas Electronics" as used in this document means Renesas Electronics Corporation and also includes its majority-owned subsidiaries.

(Note 2) "Renesas Electronics product(s)" means any product developed or manufactured by or for Renesas Electronics.



### SALES OFFICES

Renesas Electronics Corporation

<http://www.renesas.com>

Refer to "<http://www.renesas.com/>" for the latest and detailed information.

#### Renesas Electronics America Inc.

2801 Scott Boulevard Santa Clara, CA 95050-2549, U.S.A.  
Tel: +1-408-588-6000, Fax: +1-408-588-6130

#### Renesas Electronics Canada Limited

9251 Yonge Street, Suite 8309 Richmond Hill, Ontario Canada L4C 9T3  
Tel: +1-905-237-2004

#### Renesas Electronics Europe Limited

Dukes Meadow, Millboard Road, Bourne End, Buckinghamshire, SL8 5FH, U.K.  
Tel: +44-1628-585-100, Fax: +44-1628-585-900

#### Renesas Electronics Europe GmbH

Arcadiastrasse 10, 40472 Düsseldorf, Germany  
Tel: +49-211-6503-0, Fax: +49-211-6503-1327

#### Renesas Electronics (China) Co., Ltd.

Room 1709, Quantum Plaza, No.27 ZhiChunLu Haidian District, Beijing 100191, P.R.China  
Tel: +86-10-8235-1155, Fax: +86-10-8235-7679

#### Renesas Electronics (Shanghai) Co., Ltd.

Unit 301, Tower A, Central Towers, 555 Langao Road, Putuo District, Shanghai, P. R. China 200333  
Tel: +86-21-2226-0888, Fax: +86-21-2226-0999

#### Renesas Electronics Hong Kong Limited

Unit 1601-1611, 16/F., Tower 2, Grand Century Place, 193 Prince Edward Road West, Mongkok, Kowloon, Hong Kong  
Tel: +852-2265-6688, Fax: +852 2886-9022

#### Renesas Electronics Taiwan Co., Ltd.

13F, No. 363, Fu Shing North Road, Taipei 10543, Taiwan  
Tel: +886-2-8175-9600, Fax: +886 2-8175-9670

#### Renesas Electronics Singapore Pte. Ltd.

80 Bendemeer Road, Unit #06-02 Hyflux Innovation Centre, Singapore 339949  
Tel: +65-6213-0200, Fax: +65-6213-0300

#### Renesas Electronics Malaysia Sdn.Bhd.

Unit 1207, Block B, Menara Amcorp, Amcorp Trade Centre, No. 18, Jln Persiaran Barat, 46050 Petaling Jaya, Selangor Darul Ehsan, Malaysia  
Tel: +60-3-7955-9390, Fax: +60-3-7955-9510

#### Renesas Electronics India Pvt. Ltd.

No.77C, 100 Feet Road, HAL II Stage, Indiranagar, Bangalore, India  
Tel: +91-80-67208700, Fax: +91-80-67208777

#### Renesas Electronics Korea Co., Ltd.

12F., 234 Teheran-ro, Gangnam-Gu, Seoul, 135-080, Korea  
Tel: +82-2-558-3737, Fax: +82-2-558-5141

# Mouser Electronics

Authorized Distributor

Click to View Pricing, Inventory, Delivery & Lifecycle Information:

## Renesas Electronics:

[R5F10WLCGFB#30](#) [R5F10WMDAFB#30](#) [R5F10WMFAFB#50](#) [R5F10WMFAFB#30](#) [R5F10WMGAFB#50](#)  
[R5F10WLEGFB#50](#) [R5F10WLDAFB#30](#) [R5F10WLGAFB#30](#) [R5F10WLDAFA#30](#) [R5F10WLCAFB#30](#)  
[R5F10WMFAFA#30](#) [R5F10WLAFA#30](#) [R5F10WLDAFB#50](#) [R5F10WMDAFA#30](#) [R5F10WMGAFA#30](#)  
[R5F10WMEAFA#30](#) [R5F10WLFafa#30](#) [R5F10WLCafa#30](#) [R5F10WLFafb#30](#) [R5F10WMGafb#30](#)  
[R5F10WMAAFB#30](#) [R5F10WMAAFB#50](#) [R5F10WMAGFB#30](#) [R5F10WMEAFB#30](#) [R5F10WMCAFA#30](#)  
[R5F10WLAafb#50](#) [R5F10WLCAFB#50](#) [R5F10WLEAFB#50](#) [R5F10WMAAFA#50](#) [R5F10WLGAFB#50](#)  
[R5F10WLCGFB#50](#) [R5F10WLGAFB#V0](#) [R5F10WLGAFB#30](#) [R5F10WMAAFA#30](#) [R5F10WLAafb#30](#)  
[R5F10WLEAFA#30](#) [R5F10WLEGFB#30](#) [R5F10WLEAFA#50](#) [R5F10WLGFB#30](#) [R5F10WMCAFA#50](#)  
[R5F10WMCAFB#30](#) [R5F10WLEAFB#30](#) [R5F10WMEAFB#50](#) [R5F10WLAFA#50](#) [R5F10WMCAFB#50](#)  
[R5F10WLFafa#50](#) [R5F10WLFGB#30](#) [R5F10WLFGB#50](#) [R5F10WLAGFB#30](#) [R5F10WLAGFB#50](#)  
[R5F10WLCafa#50](#) [R5F10WLDAFA#50](#) [R5F10WLDGFB#30](#) [R5F10WLDGFB#50](#) [R5F10WMGGFB#50](#)  
[R5F10WMEGFB#50](#) [R5F10WMFAFA#50](#) [R5F10WMFGFB#30](#) [R5F10WMFGFB#50](#) [R5F10WMGAFA#50](#)  
[R5F10WMGGFB#30](#) [R5F10WMDAFA#50](#) [R5F10WMDAFB#50](#) [R5F10WMDGFB#30](#) [R5F10WMDGFB#50](#)  
[R5F10WMEAFA#50](#) [R5F10WMEGFB#30](#) [R5F10WLFafb#50](#) [R5F10WLGafa#50](#) [R5F10WLGFB#50](#)  
[R5F10WMAGFB#50](#) [R5F10WMCGB#30](#) [R5F10WMCGB#50](#)

Компания «Океан Электроники» предлагает заключение долгосрочных отношений при поставках импортных электронных компонентов на взаимовыгодных условиях!

Наши преимущества:

- Поставка оригинальных импортных электронных компонентов напрямую с производств Америки, Европы и Азии, а так же с крупнейших складов мира;
- Широкая линейка поставок активных и пассивных импортных электронных компонентов (более 30 млн. наименований);
- Поставка сложных, дефицитных, либо снятых с производства позиций;
- Оперативные сроки поставки под заказ (от 5 рабочих дней);
- Экспресс доставка в любую точку России;
- Помощь Конструкторского Отдела и консультации квалифицированных инженеров;
- Техническая поддержка проекта, помощь в подборе аналогов, поставка прототипов;
- Поставка электронных компонентов под контролем ВП;
- Система менеджмента качества сертифицирована по Международному стандарту ISO 9001;
- При необходимости вся продукция военного и аэрокосмического назначения проходит испытания и сертификацию в лаборатории (по согласованию с заказчиком);
- Поставка специализированных компонентов военного и аэрокосмического уровня качества (Xilinx, Altera, Analog Devices, Intersil, Interpoint, Microsemi, Actel, Aeroflex, Peregrine, VPT, Syfer, Eurofarad, Texas Instruments, MS Kennedy, Miteq, Cobham, E2V, MA-COM, Hittite, Mini-Circuits, General Dynamics и др.);

Компания «Океан Электроники» является официальным дистрибьютором и эксклюзивным представителем в России одного из крупнейших производителей разъемов военного и аэрокосмического назначения «**JONHON**», а так же официальным дистрибьютором и эксклюзивным представителем в России производителя высокотехнологичных и надежных решений для передачи СВЧ сигналов «**FORSTAR**».



## JONHON

«**JONHON**» (основан в 1970 г.)

Разъемы специального, военного и аэрокосмического назначения:

(Применяются в военной, авиационной, аэрокосмической, морской, железнодорожной, горно- и нефтедобывающей отраслях промышленности)

«**FORSTAR**» (основан в 1998 г.)

ВЧ соединители, коаксиальные кабели, кабельные сборки и микроволновые компоненты:

(Применяются в телекоммуникациях гражданского и специального назначения, в средствах связи, РЛС, а так же военной, авиационной и аэрокосмической отраслях промышленности).



Телефон: 8 (812) 309-75-97 (многоканальный)

Факс: 8 (812) 320-03-32

Электронная почта: [ocean@oceanchips.ru](mailto:ocean@oceanchips.ru)

Web: <http://oceanchips.ru/>

Адрес: 198099, г. Санкт-Петербург, ул. Калинина, д. 2, корп. 4, лит. А