

**HIGH REPEATABILITY,
BROADBAND TO-5 RELAYS
DPDT**



| SERIES | RELAY TYPE |
|--------|----------------------|
| RF300 | Repeatable, RF relay |

DESCRIPTION

The ultraminiature RF300 relays are designed to provide improved RF signal switching repeatability over the frequency range. These relays are engineered for use in RF attenuator, RF switch matrices, ATE and other applications that require dependable high frequency signal fidelity and performance.

The RF300 features:

- High repeatability
- Broader bandwidth
- Metal enclosure for EMI shielding
- High isolation between control and signal paths
- High resistance to ESD

The following unique construction features and manufacturing techniques provide excellent robustness to environmental extremes and overall high reliability:

- Uniframe motor design provides high magnetic efficiency and mechanical rigidity
- Minimum mass components and welded construction provide maximum resistance to shock and vibration
- Advanced cleaning techniques provide maximum assurance of internal cleanliness
- Hermetically sealed
- Solder Dipped Leads, (RoHS compliant solder option available)

| ENVIRONMENTAL AND PHYSICAL SPECIFICATIONS | | |
|---|------------------|--------------------------|
| Temperature (Ambient) | Storage | -65°C to +125°C |
| | Operating | -55°C to +85°C |
| Vibration (General Note I) | | 10 g's to 500 Hz |
| Shock (General Note I) | | 30 g's, 6ms half sine |
| Enclosure | | Hermetically sealed |
| Weight | RF300 | 0.09 oz. (2.55g) max. |

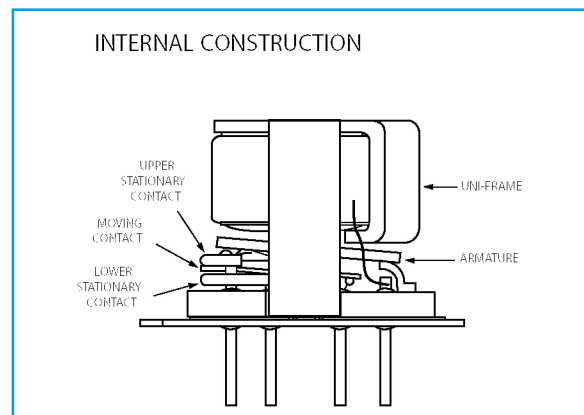

SERIES RF300
TYPICAL RF CHARACTERISTICS (See RF Notes)

Isolation Across Contacts (RF Note 4)

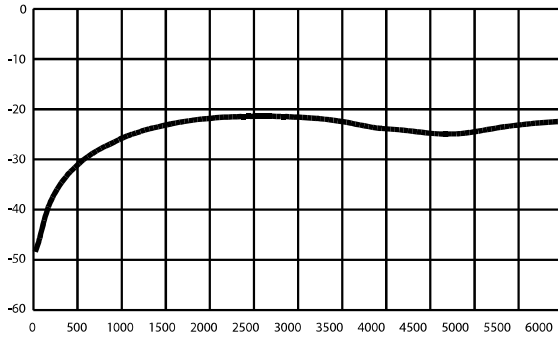

Isolation Pole to Pole (RF Note 5)

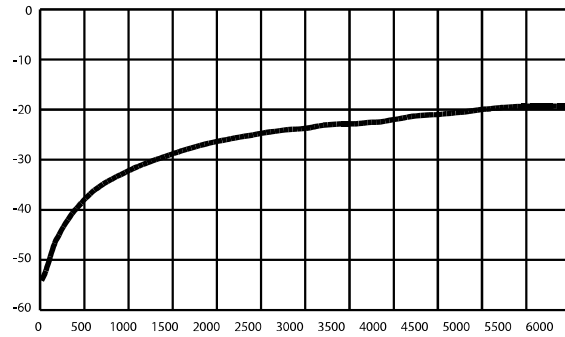

Insertion Loss (RF Note 6)

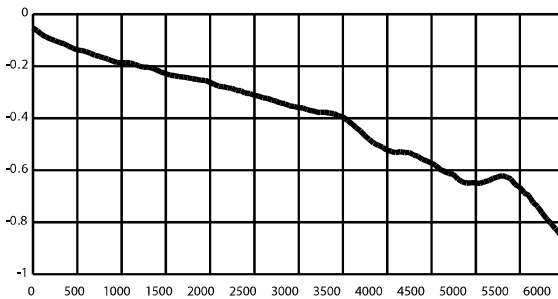

VSWR (RF Note 6)

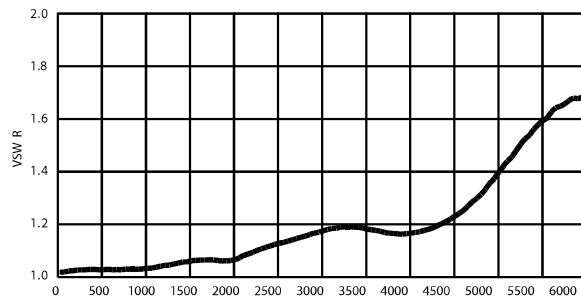

RF300 Time Response (RF Note 6)

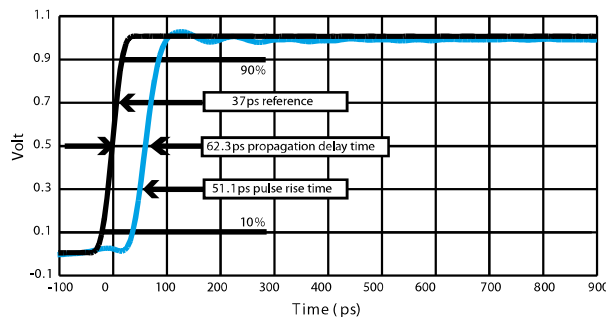

RF NOTES

- Test conditions:
 - Fixture: .031" copper clad, reinforced PTFE, RT/duroid® 6002 with SMA connectors. (RT/duroid® is a registered trademark of Rogers Corporation.)
 - Room ambient temperature.
 - Terminals not tested were terminated with 50-ohm load.
 - Contact signal level: -10 dBm.
 - No. of test samples: 4.
- Data presented herein represents typical characteristics and is not intended for use as specification limits.
- Data is per pole, except for pole-to-pole data.
- Data is the average from readings taken on all open contacts.
- Data is the average from readings taken on poles with coil energized and de-energized.
- Data is the average from readings taken on all closed contacts.
- Test fixture effect de-embedded from frequency and time response data.

SERIES RF300
TYPICAL RF REPEATABILITY PERFORMANCE (See RF Notes 1,2 and 3)

1 Million Cycle Repeatability ±0.1 dB from DC to 3GHz

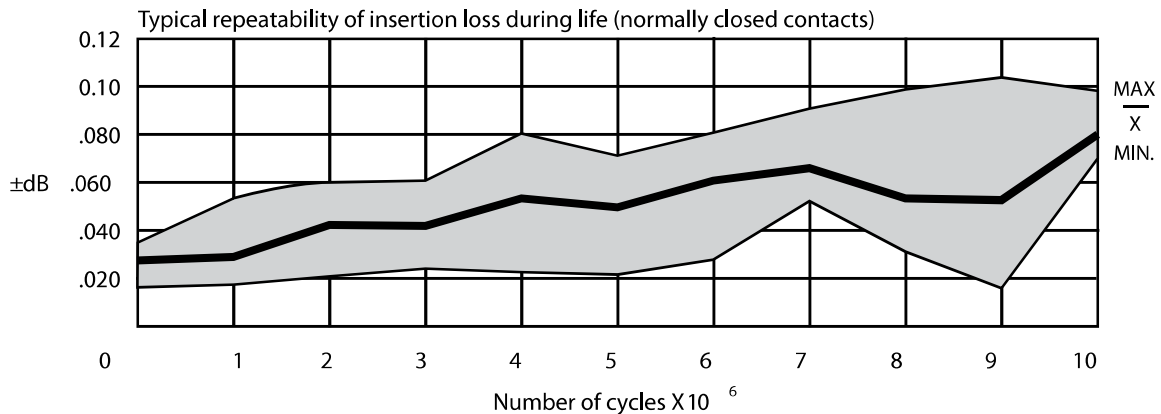
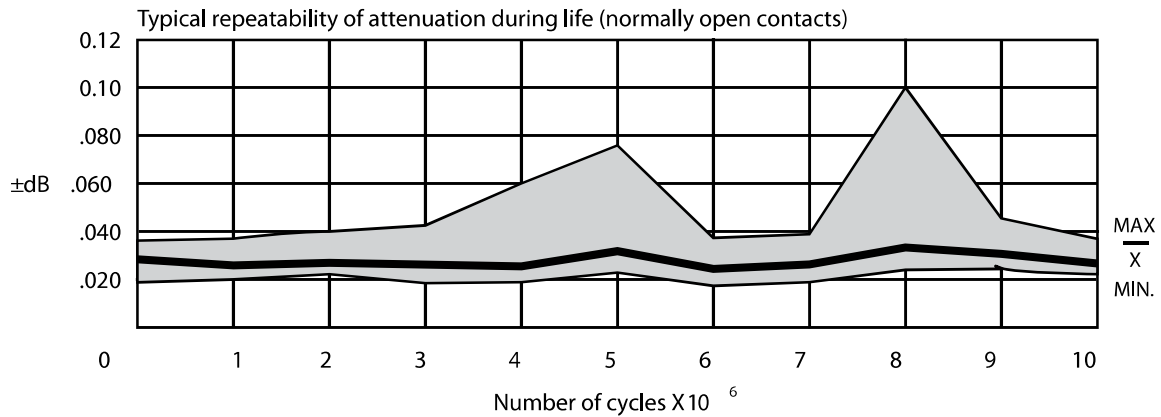

RF NOTES

1. One million cycle repeatability data is based upon 396 observations with an average repeatability ±0.033 dB and a range of ±0.093 dB.
2. Repeatability of attenuation values were obtained from tests conducted in a 20 dB attenuator network with a 0 dBm input signal.
3. Relay operates at frequencies higher than 3 GHz with reduced RF performance characteristics.
4. Curves were developed from tests performed on a 0.031" copper clad, reinforced PTFE circuit board at 20°C (ref). The unutilized contacts were terminated in 50 ohms; characteristic impedance of measuring equipment is 50 ohms. The relays were mounted flush to the circuit board ground plane without the relay header soldered to the ground plane.

SERIES RF300
GENERAL ELECTRICAL SPECIFICATIONS (@25°C)

| | | |
|---------------------------------|---|---------------------------------|
| Contact Arrangement | 2 Form C (DPDT) | |
| Rated Duty | Continuous | |
| Contact Resistance | 0.15 Ω max. | |
| Contact Load Rating | Resistive: 1Amp/28Vdc Low level: 10 to 50 μA @ 10 to 50 mV | |
| Contact Life Ratings | 10,000,000 cycles (typical) at low level | |
| Coil Operating Power | RF300-5: 500 mW @ nominal coil | RF300-12: 370 mW @ nominal coil |
| Operate Time | RF300: 4.0 mS max. | |
| Release Time | RF300: 3.0 mS max. | |
| Intercontact Capacitance | 0.4 pf typical | |
| Insulation Resistance | 1,000 MΩ min. between mutually isolated terminals | |
| Dielectric Strength | 350 Vrms (60 Hz) @ atmospheric pressure | |

DETAILED ELECTRICAL SPECIFICATIONS (@25°C)

| BASE PART NUMBERS (RF300) | | RF300-5 | RF300-12 |
|------------------------------------|--------------|----------------|-----------------|
| Coil Voltage, Nominal (Vdc) | | 5.0 | 12.0 |
| Coil Resistance (Ohms ±20%) | RF300 | 50 | 390 |
| Pick-up Voltage (Vdc max.) | RF300 | 3.6 | 9.0 |

SERIES RF300
OUTLINE DIMENSIONS

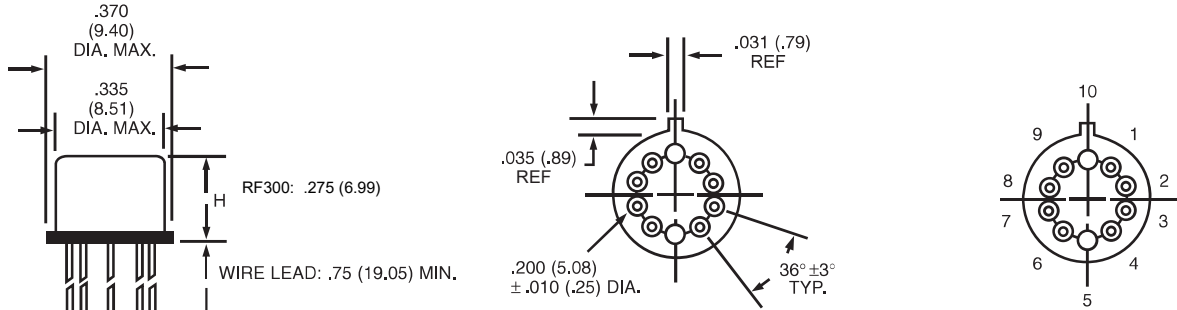

DIMENSIONS ARE SHOWN IN INCHES (MILLIMETERS)
(Viewed from Terminals)

SCHEMATIC DIAGRAMS

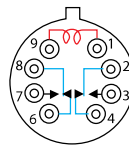

RF300

NOTES:

1. DIMENSIONS ARE IN INCHES, METRIC EQUIVALENTS SHOWN IN ().
2. POSITIONS 5 AND 10 ARE FOR UNINSULATED CASE GROUND OPTIONS.
3. NO PROTRUSION BELOW BOTTOM OF HEADER WHEN GROUND PINS ARE INSTALLED
4. TO ORDER THE CASE GROUND OPTION, AFTER THE SERIES DESIGNATOR, ADD "Y" TO THE PART NUMBER FOR POSITION 5 OR "Z" TO THE PART NUMBER FOR POSITION 10.

Teledyne Part Numbering System for RF300 Relays

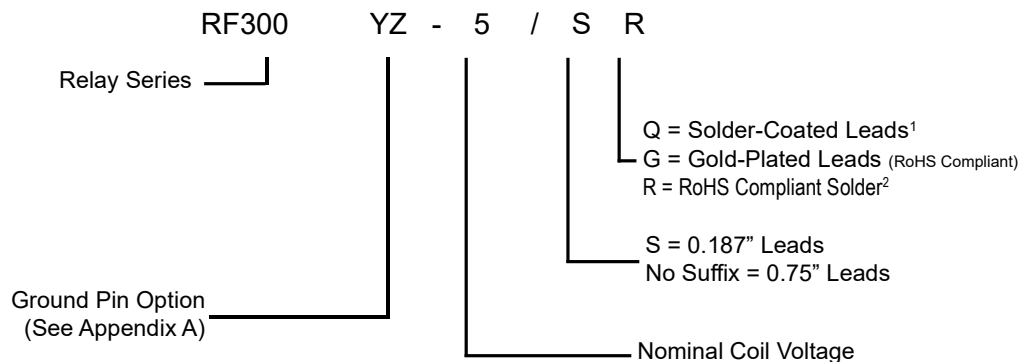

Note: Parts ordered without suffix may be supplied with Solder-Coated or Gold-Plated leads

¹ Parts ordered with Solder-Coated leads will have (Sn60/Pb40)

² Parts ordered with RoHS Solder-Coated leads will have (Sn99.3/Cu0.7)

³ The slash and characters appearing after the slash are not marked on the relay.

GENERAL NOTES

- Relays will exhibit no contact chatter in excess of 10 μsec or transfer in excess of 1 μsec.
- For reference only. Coil resistance not directly measureable at relay terminals due to internal series diode.

SERIES RF300
TYPICAL SIGNAL INTEGRITY CHARACTERISTICS @ 10 Gbps

Normally Closed (Typ.)

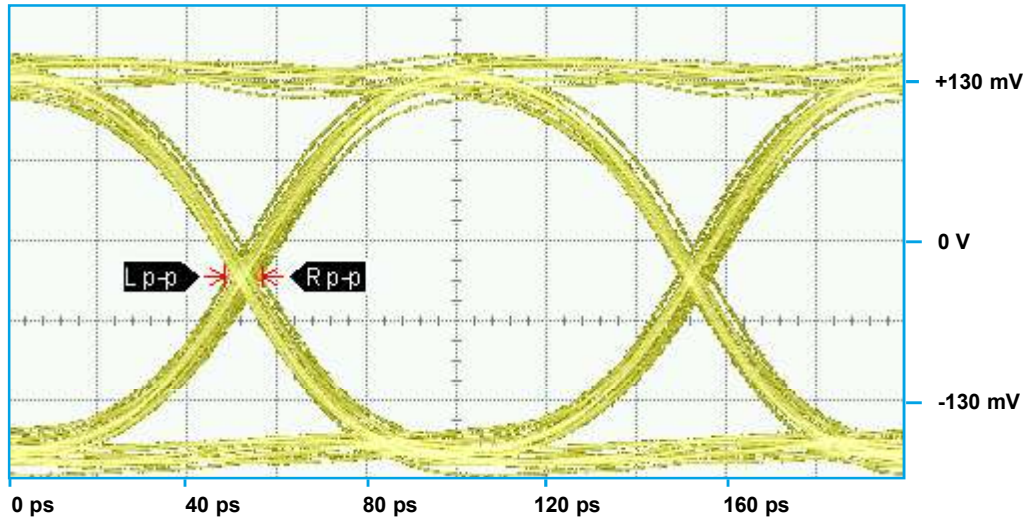

| Bit Rate | Eye Height | Eye Width | Jitter _{P-P} |
|----------|------------|-----------|-----------------------|
| 10 Gbps | 254.7 mV | 90.38 ps | 8.44 ps |

Normally Open (Typ.)

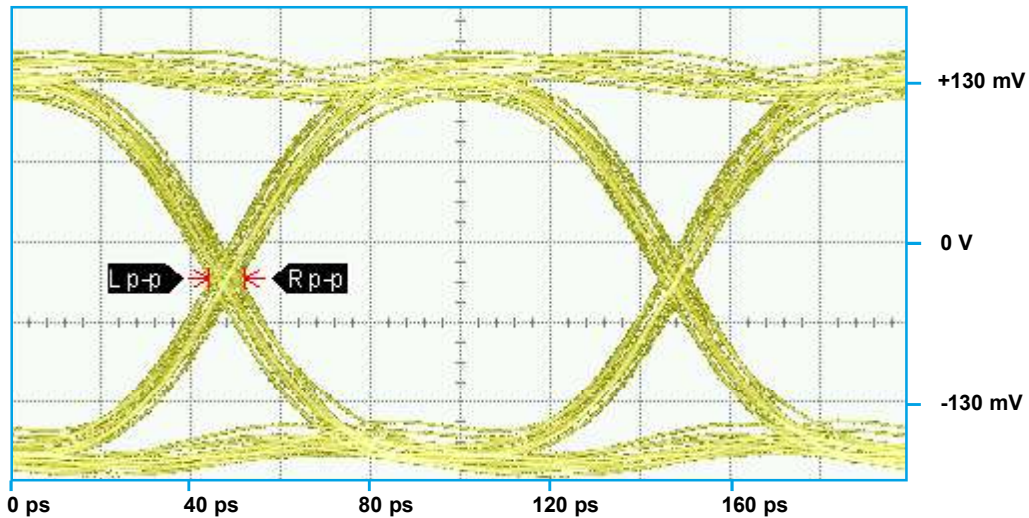

| Bit Rate | Eye Height | Eye Width | Jitter _{P-P} |
|----------|------------|-----------|-----------------------|
| 10 Gbps | 250.9 mV | 88.21 ps | 8.00 ps |

PATTERN GENERATOR SETTINGS

- 10 Gbps Random Pulse Pattern Generator
- $2^{31} - 1$ PRBS signal
- PRBS output of 300 mV_{P-P} (nominal)
- RF PCB effect (negligible) not removed from measurement
- Data shown is typical of both poles

SERIES RF300
TYPICAL SIGNAL INTEGRITY CHARACTERISTICS @ 18 Gbps

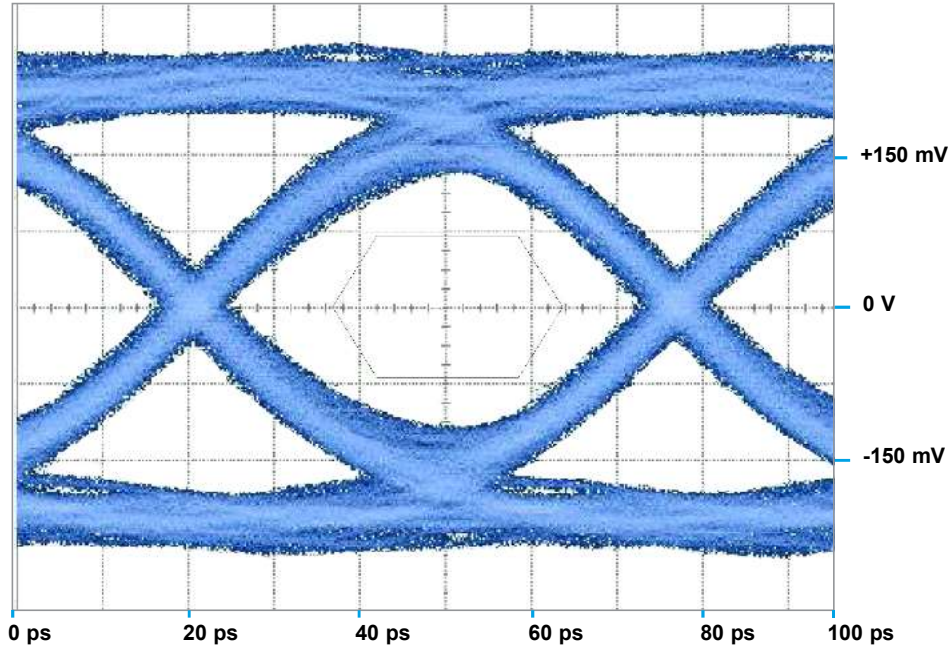

| Bit Rate | Eye Height | Eye Width | Jitter _{P-P} |
|----------|------------|-----------|-----------------------|
| 18 Gbps | 185 mV | 46.4 ps | 10.44 ps |

PATTERN GENERATOR SETTINGS

- 18 Gbps Random Pulse Pattern Generator
- $2^{31} - 1$ PRBS signal
- PRBS output of 500 mV_{P-P} (nominal)
- RF PCB effect (negligible) not removed from measurement
- Data shown is typical of both poles

APPENDIX A : Spacer Pads

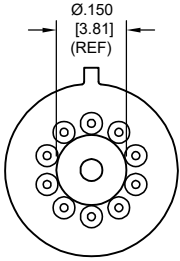
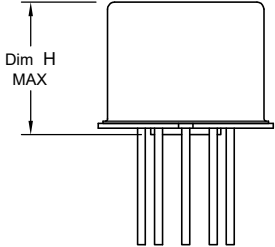
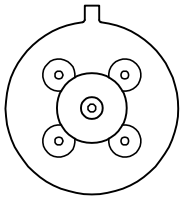
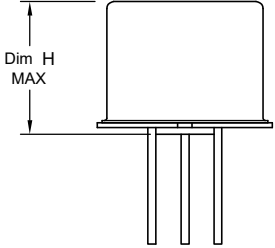
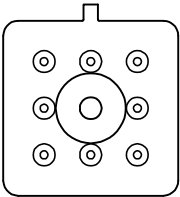
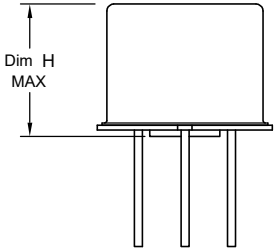
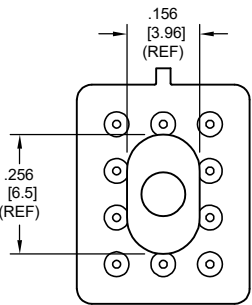
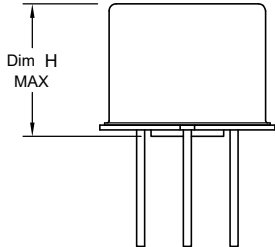
| Pad designation and bottom view dimensions | Height | For use with the following: | Dim. H Max. |
|--|---|------------------------------|--------------|
|  <p style="text-align: center;">"M4" Spacer Pad for TO-5</p> |  | ER412 | .295 (7.49) |
| | | 712, RF300, RF, RF700, RF703 | .300 (7.62) |
| | | ER422, 722 | .305 (7.75) |
| | | ER432 | .400 (10.16) |
| | | 732, RF303 | .410 (10.41) |
| | | RF312 | .350 (8.89) |
|  <p style="text-align: center;">"M4" Spacer Pad for TO-5</p> |  | ER411 | .295 (7.49) |
| | | RF311 | .300 (7.62) |
| | | RF331 | .410 (10.41) |
|  <p style="text-align: center;">"M4" Spacer Pad for Centigrid®</p> |  | 172 | .305 (7.75) |
| | | ER114, J114 | .300 (7.62) |
| | | ER134, J134 | .400 (10.16) |
| | | RF100 | .315 (8.00) |
| | | RF103 | .420 (10.67) |
|  <p style="text-align: center;">"M9" Spacer Pad for Centigrid®</p> |  | 122C, A152 | .320 (8.13) |
| | | ER116C, J116C | .300 (7.62) |
| | | ER136C, J136C | .400 (10.16) |
| | | RF180 | .325 (8.25) |
| | | A150 | .305 (7.75) |

Notes:

1. Spacer pad material: Polyester film.
2. To specify an "M4" or "M9" spacer pad, refer to the mounting variants portion of the part numbering example in the applicable datasheet.
3. Dimensions are in inches (mm).
4. Unless otherwise specified, tolerance is $\pm .010"$ (.25 mm).
5. Add 10 m Ω to the contact resistance shown in the datasheet.
6. Add 0.01 oz. (0.25 g) to the weight of the relay assembly shown in the datasheet.

APPENDIX A : Spreader Pads

Pad designation and bottom view dimensions

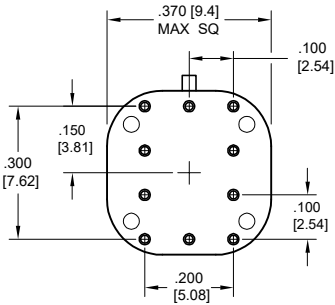

"M" Spreader Pad 5/ 6/

Height

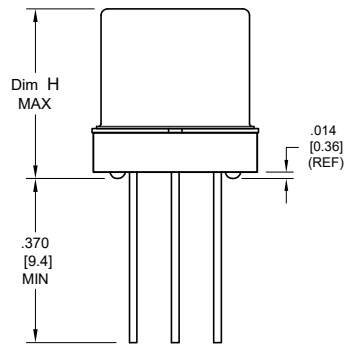

For use with the following:

Dim. H Max.

| | |
|------------------------|--------------|
| ER411T, ER412, J412 | .388 (9.86) |
| 712 | .393 (9.99) |
| ER432, J432 | .493 (12.52) |
| 732 | .503 (12.78) |
| J421, J422, ER422, 722 | .398 (10.11) |

Notes:

1. Spreader pad material: Diallyl Phthalate.
2. To specify an "M", "M2" or "M3" spreader pad, refer to the mounting variants portion of the part number example in the applicable datasheet.
3. Dimensions are in inches (mm).
4. Unless otherwise specified, tolerance is $\pm .010$ " (0.25 mm).
- 5/. Add 25 m Ω to the contact resistance shown in the datasheet.
- 6/. Add .01 oz. (0.25 g) to the weight of the relay assembly shown in the datasheet.
- 7/. Add 50 m Ω to the contact resistance shown in the datasheet.
- 8/. Add 0.025 oz (0.71 g) to the weight of the relay assembly shown in the datasheet.
- 9/. M3 pad to be used only when the relay has a center pin (e.g. ER411M3-12A, 722XM3-26.)

APPENDIX A : Ground Pin Positions

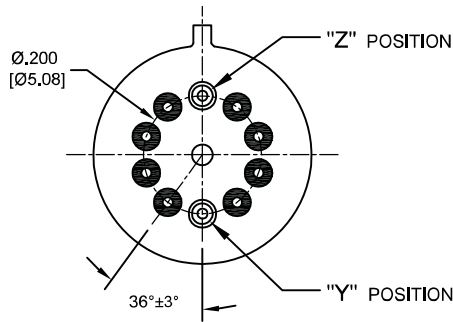

TO-5 Relays:

ER412, ER412T, ER422, ER432, ER432T, 712, 712TN, 400H, 400K, 400V, RF300, RF303, RF341, RF312, RF332, RF310, RF313, RF320, RF323, SI800, SI803, RF700, RF703

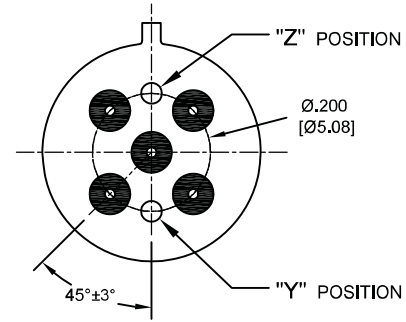

TO-5 Relays:

ER411, RF311, RF331

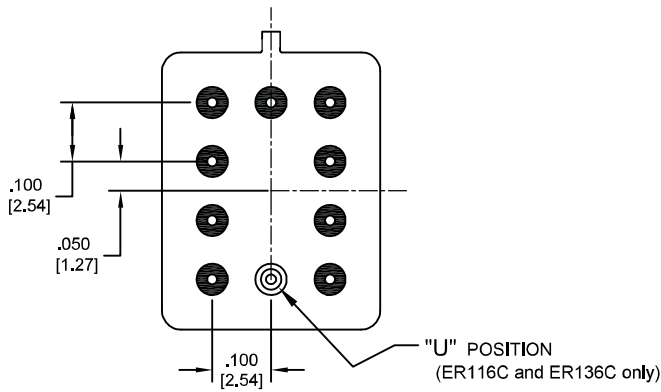

Centigrad® Relays:

RF180, ER116C, 122C, ER136C

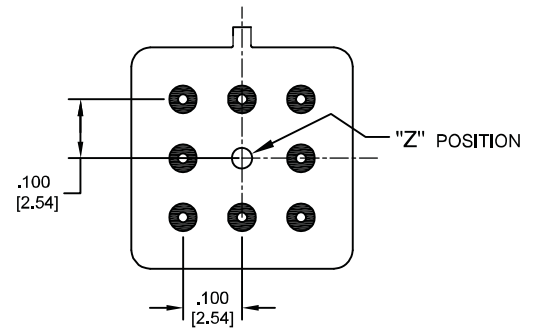

Centigrad® Relays:

RF100, RF103, ER114, ER134, 172

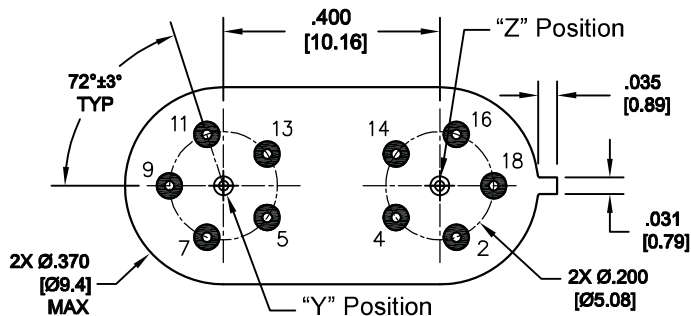

Loopback Relays:

LB363

- Indicates ground pin position
- Indicates glass insulated lead position
- ◎ Indicates ground pin or lead position depending on relay type

NOTES

1. Terminal views shown
2. Dimensions are in inches (mm)
3. Tolerances: $\pm .010$ ($\pm .25$) unless otherwise specified
4. Ground pin positions are within .015 (0.38) dia. of true position
5. Ground pin head dia., 0.035 (0.89) ref: height 0.010 (0.25) ref.
6. Lead dia. 0.017 (0.43) nom.

Компания «Океан Электроники» предлагает заключение долгосрочных отношений при поставках импортных электронных компонентов на взаимовыгодных условиях!

Наши преимущества:

- Поставка оригинальных импортных электронных компонентов напрямую с производств Америки, Европы и Азии, а так же с крупнейших складов мира;
- Широкая линейка поставок активных и пассивных импортных электронных компонентов (более 30 млн. наименований);
- Поставка сложных, дефицитных, либо снятых с производства позиций;
- Оперативные сроки поставки под заказ (от 5 рабочих дней);
- Экспресс доставка в любую точку России;
- Помощь Конструкторского Отдела и консультации квалифицированных инженеров;
- Техническая поддержка проекта, помощь в подборе аналогов, поставка прототипов;
- Поставка электронных компонентов под контролем ВП;
- Система менеджмента качества сертифицирована по Международному стандарту ISO 9001;
- При необходимости вся продукция военного и аэрокосмического назначения проходит испытания и сертификацию в лаборатории (по согласованию с заказчиком);
- Поставка специализированных компонентов военного и аэрокосмического уровня качества (Xilinx, Altera, Analog Devices, Intersil, Interpoint, Microsemi, Actel, Aeroflex, Peregrine, VPT, Syfer, Eurofarad, Texas Instruments, MS Kennedy, Miteq, Cobham, E2V, MA-COM, Hittite, Mini-Circuits, General Dynamics и др.);

Компания «Океан Электроники» является официальным дистрибьютором и эксклюзивным представителем в России одного из крупнейших производителей разъемов военного и аэрокосмического назначения «**JONHON**», а так же официальным дистрибьютором и эксклюзивным представителем в России производителя высокотехнологичных и надежных решений для передачи СВЧ сигналов «**FORSTAR**».



JONHON

«**JONHON**» (основан в 1970 г.)

Разъемы специального, военного и аэрокосмического назначения:

(Применяются в военной, авиационной, аэрокосмической, морской, железнодорожной, горно- и нефтедобывающей отраслях промышленности)

«**FORSTAR**» (основан в 1998 г.)

ВЧ соединители, коаксиальные кабели, кабельные сборки и микроволновые компоненты:

(Применяются в телекоммуникациях гражданского и специального назначения, в средствах связи, РЛС, а так же военной, авиационной и аэрокосмической отраслях промышленности).



Телефон: 8 (812) 309-75-97 (многоканальный)

Факс: 8 (812) 320-03-32

Электронная почта: ocean@oceanchips.ru

Web: <http://oceanchips.ru/>

Адрес: 198099, г. Санкт-Петербург, ул. Калинина, д. 2, корп. 4, лит. А