

## CUTE-3-M

~25° medium beam with 1.5 mm high location pins

### TECHNICAL SPECIFICATIONS:

Dimensions	Ø 35.0 mm
Height	15 mm
Fastening	glue, pin
ROHS compliant	yes ⓘ

### MATERIAL SPECIFICATIONS:

Component	Type	Material	Colour	Finish
CUTE-3-M	Multi-lens	PMMA	clear	



### ORDERING INFORMATION:

Component	Qty in box	MOQ	MPQ	Box weight (kg)
C11334_CUTE-3-M » Box size: 480 x 280 x 300 mm	630	90	45	6.8

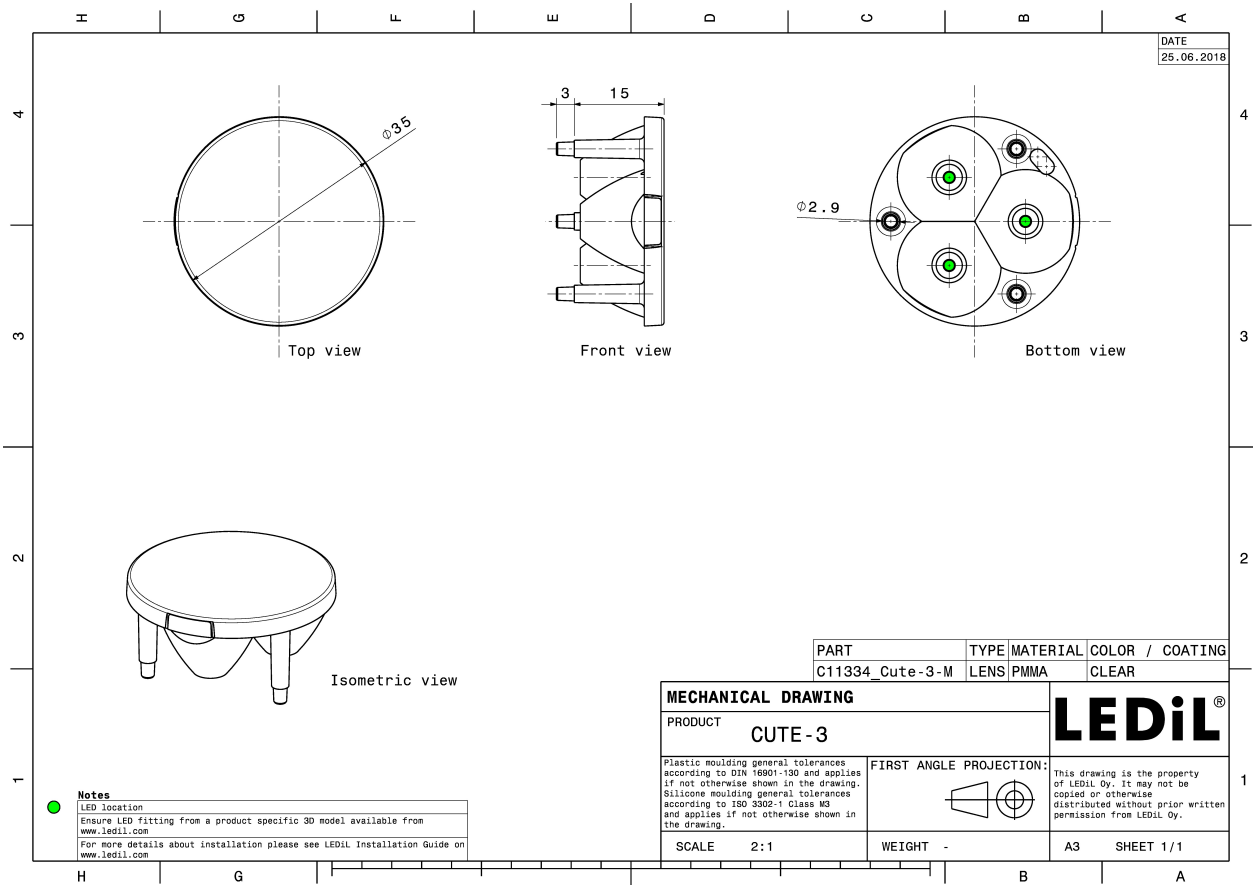

**PHOTOMETRIC DATA (MEASURED):**

**CREE** 

LED XM-L  
FWHM 25.0°  
Efficiency 90 %  
Peak intensity cd/lm  
LEDs/each optic 1  
Light colour White  
Required components:

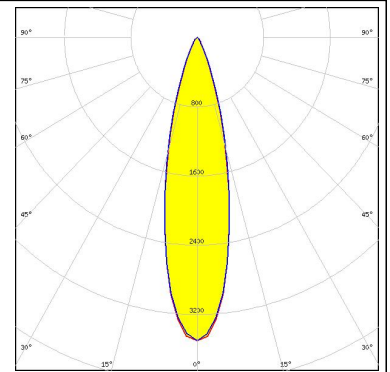
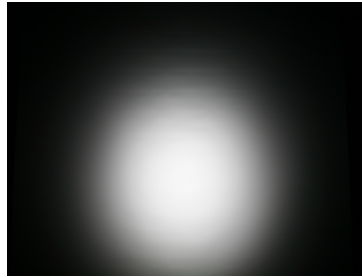

**CREE** 

LED XM-L2  
FWHM 26.0°  
Efficiency 89 %  
Peak intensity 3.700 cd/lm  
LEDs/each optic 1  
Light colour White  
Required components:

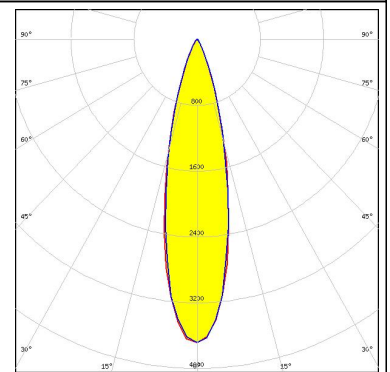
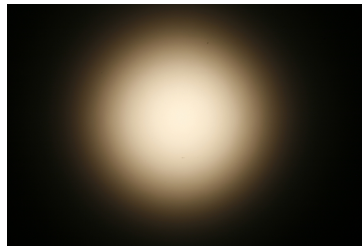

**CREE** 

LED XP-E  
FWHM 22.0°  
Efficiency 91 %  
Peak intensity cd/lm  
LEDs/each optic 1  
Light colour White  
Required components:

**CREE** 

LED XP-G  
FWHM 24.0°  
Efficiency 91 %  
Peak intensity cd/lm  
LEDs/each optic 1  
Light colour White  
Required components:

## PHOTOMETRIC DATA (MEASURED):

### **CREE**

LED XP-L HD  
FWHM 24.0°  
Efficiency 88 %  
Peak intensity 3.900 cd/lm  
LEDs/each optic 1  
Light colour White  
Required components:



### **LUMILEDS**

LED LUXEON A  
FWHM 24.0°  
Efficiency %  
Peak intensity cd/lm  
LEDs/each optic 1  
Light colour White  
Required components:

### **LUMILEDS**

LED LUXEON Rebel  
FWHM 22.0°  
Efficiency 91 %  
Peak intensity cd/lm  
LEDs/each optic 1  
Light colour White  
Required components:

### **LUMILEDS**

LED LUXEON Rebel ES  
FWHM 24.0°  
Efficiency 92 %  
Peak intensity cd/lm  
LEDs/each optic 1  
Light colour White  
Required components:

**PHOTOMETRIC DATA (MEASURED):**

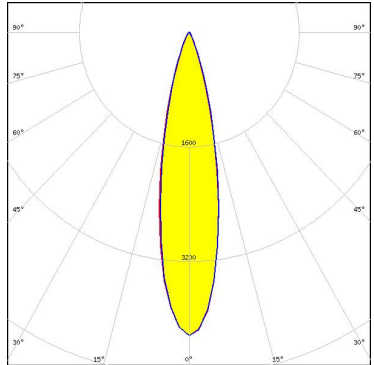
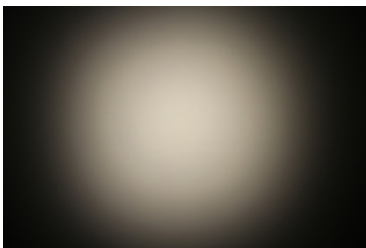
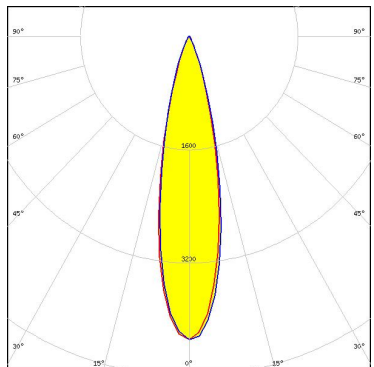
<p><b>LUMILEDS</b></p> <p>LED LUXEON T            FWHM 23.0°            Efficiency 89 %            Peak intensity 4.200 cd/lm            LEDs/each optic 1            Light colour White            Required components:</p>		
<p><b>LUMILEDS</b></p> <p>LED LUXEON TX            FWHM 25.0°            Efficiency 88 %            Peak intensity 4.300 cd/lm            LEDs/each optic 1            Light colour White            Required components:</p>		
<p><b>NICHIA</b></p> <p>LED NCSxx19A            FWHM 25.0°            Efficiency 88 %            Peak intensity cd/lm            LEDs/each optic 1            Light colour White            Required components:</p>		
<p><b>NICHIA</b></p> <p>LED NVSxx19A            FWHM 25.0°            Efficiency 88 %            Peak intensity cd/lm            LEDs/each optic 1            Light colour White            Required components:</p>		

#### PHOTOMETRIC DATA (MEASURED):

##### OSRAM

Opto Semiconductors

LED OSLON SSL 150  
FWHM 24.0°  
Efficiency %  
Peak intensity cd/lm  
LEDs/each optic 1  
Light colour White  
Required components:

##### OSRAM

Opto Semiconductors

LED OSLON SSL 80  
FWHM 22.0°  
Efficiency 89 %  
Peak intensity cd/lm  
LEDs/each optic 1  
Light colour White  
Required components:

##### TOSHIBA

Leading Innovation >>>

LED TL1L3  
FWHM 26.0°  
Efficiency 86 %  
Peak intensity 2.600 cd/lm  
LEDs/each optic 1  
Light colour White  
Required components:

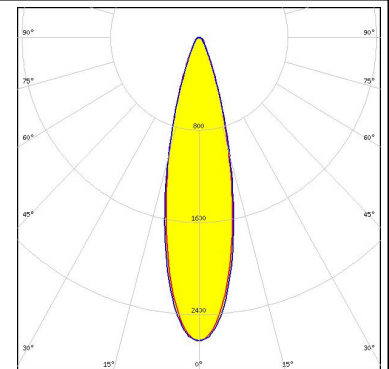
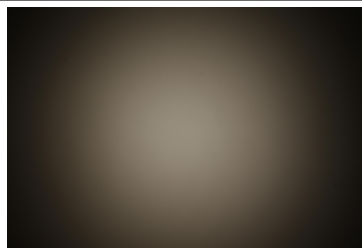

**PHOTOMETRIC DATA (SIMULATED):**



LED XM-L HVW  
 FWHM 33.0°  
 Efficiency %  
 Peak intensity cd/lm  
 LEDs/each optic 1  
 Light colour White  
 Required components:



LED XT-E HVW  
 FWHM 30.0°  
 Efficiency %  
 Peak intensity cd/lm  
 LEDs/each optic 1  
 Light colour White  
 Required components:



LED LUXEON H50-2  
 FWHM 30.0°  
 Efficiency 90 %  
 Peak intensity 2.700 cd/lm  
 LEDs/each optic 1  
 Light colour White  
 Required components:

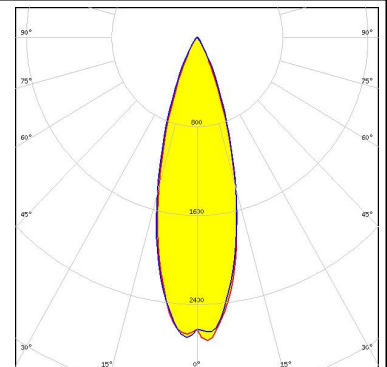

LED NVSxx19B/NVSxx19C  
 FWHM 30.0°  
 Efficiency 89 %  
 Peak intensity 2.530 cd/lm  
 LEDs/each optic 1  
 Light colour White  
 Required components:

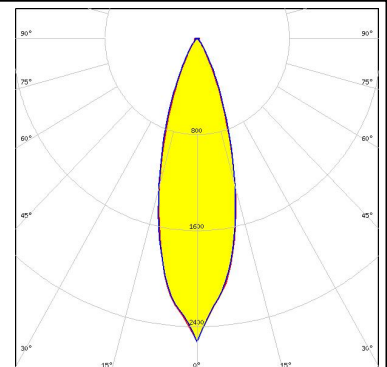

## PHOTOMETRIC DATA (SIMULATED):

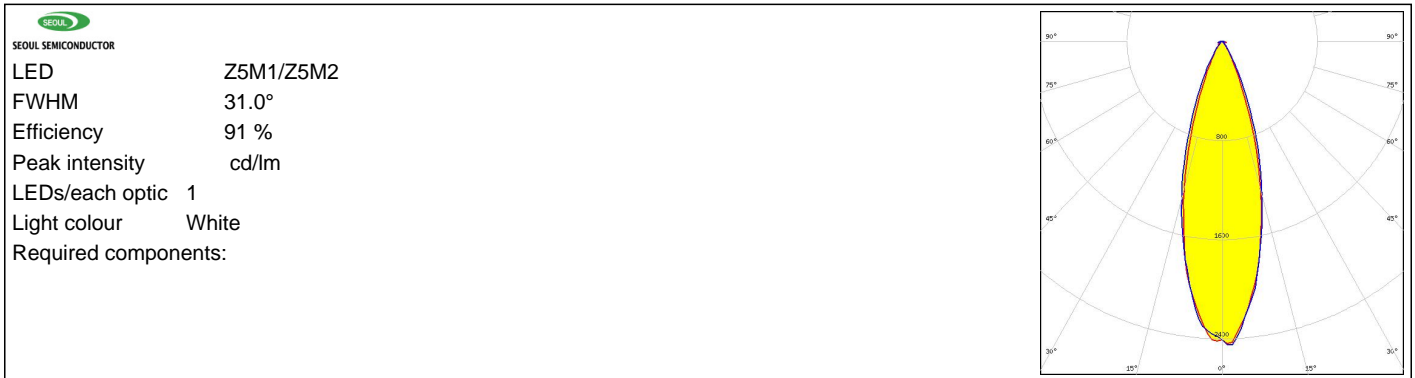



### GENERAL INFORMATION:

NOTE: The typical beam angle will be changed by different color, chip size and chip position tolerance. The typical total beam angle is the full angle measured where the luminous intensity is half of the peak value.

### MATERIALS:

As part of our continuous research and improvement processes, and to ensure the best possible quality and availability of our products, LEDiL reserves the right to change material grades without notice.

### PRODUCT DATA USER AGREEMENT AND DISCLAIMER:

The measured data in the provided downloadable LEDiL Product Datasheets and Mechanical 2D-Drawings is rounded and provided as reference for planning. LEDiL Oy's optical specifications have been verified by conducting performance testing of the products in accordance with the company's quality system. The reported data are averaged results of multiple measurements with typical variation. LEDiL Oy reserves the right to without prior notification make changes and improvements to its products.

LEDiL Oy assumes neither warranty, nor guarantee nor any other liability of any kind for the contents and correctness of the provided data. The provided data has been generated with highest diligence but the provided data may in reality not represent the complete possible variation range of all intrinsic parameters. Therefore, in certain cases a deviation from the provided data could occur.

LEDiL Oy reserves the right to undertake technical changes of its products without further notification which could lead to changes in the provided data. LEDiL Oy assumes no liability of any kind for the possible deviation from any provided data or any other damage resulting from the usage of the provided data.

The user agrees to this disclaimer and user agreement with the download or usage of the provided files.

#### LEDiL Oy

Joensuunkatu 13  
FI-24240 SALO  
Finland

#### LEDiL Inc.

228 West Page Street  
Suite D  
Sycamore IL 60178  
USA

#### Local sales and technical support

[www.ledil.com/  
where\\_to\\_buy](http://www.ledil.com/where_to_buy)

#### Shipping locations

Salo, Finland  
Hong Kong, China

#### Distribution Partners

[www.ledil.com/  
where\\_to\\_buy](http://www.ledil.com/where_to_buy)

Компания «Океан Электроники» предлагает заключение долгосрочных отношений при поставках импортных электронных компонентов на взаимовыгодных условиях!

Наши преимущества:

- Поставка оригинальных импортных электронных компонентов напрямую с производств Америки, Европы и Азии, а так же с крупнейших складов мира;
- Широкая линейка поставок активных и пассивных импортных электронных компонентов (более 30 млн. наименований);
- Поставка сложных, дефицитных, либо снятых с производства позиций;
- Оперативные сроки поставки под заказ (от 5 рабочих дней);
- Экспресс доставка в любую точку России;
- Помощь Конструкторского Отдела и консультации квалифицированных инженеров;
- Техническая поддержка проекта, помощь в подборе аналогов, поставка прототипов;
- Поставка электронных компонентов под контролем ВП;
- Система менеджмента качества сертифицирована по Международному стандарту ISO 9001;
- При необходимости вся продукция военного и аэрокосмического назначения проходит испытания и сертификацию в лаборатории (по согласованию с заказчиком);
- Поставка специализированных компонентов военного и аэрокосмического уровня качества (Xilinx, Altera, Analog Devices, Intersil, Interpoint, Microsemi, Actel, Aeroflex, Peregrine, VPT, Syfer, Eurofarad, Texas Instruments, MS Kennedy, Miteq, Cobham, E2V, MA-COM, Hittite, Mini-Circuits, General Dynamics и др.);

Компания «Океан Электроники» является официальным дистрибьютором и эксклюзивным представителем в России одного из крупнейших производителей разъемов военного и аэрокосмического назначения «JONHON», а так же официальным дистрибьютором и эксклюзивным представителем в России производителя высокотехнологичных и надежных решений для передачи СВЧ сигналов «FORSTAR».



## JONHON

«JONHON» (основан в 1970 г.)

Разъемы специального, военного и аэрокосмического назначения:

(Применяются в военной, авиационной, аэрокосмической, морской, железнодорожной, горно- и нефтедобывающей отраслях промышленности)

«FORSTAR» (основан в 1998 г.)

ВЧ соединители, коаксиальные кабели, кабельные сборки и микроволновые компоненты:

(Применяются в телекоммуникациях гражданского и специального назначения, в средствах связи, РЛС, а так же военной, авиационной и аэрокосмической отраслях промышленности).



Телефон: 8 (812) 309-75-97 (многоканальный)

Факс: 8 (812) 320-03-32

Электронная почта: [ocean@oceanchips.ru](mailto:ocean@oceanchips.ru)

Web: <http://oceanchips.ru/>

Адрес: 198099, г. Санкт-Петербург, ул. Калинина, д. 2, корп. 4, лит. А