



Index

Series 18

	Description	Page 431
	Product Assembly	Page 432
	Product Range	
	- pushbuttons for standard mounting	Page 433
	- pushbuttons for flush mounting	Page 434
	- accessories / spare parts	Page 435
	Technical Data	Page 438
	Technical Drawing / Dimension / Layout	Page 439
Circuit Drawing	Page 442	

General Notes

The series 18 comprises compact indicators for direct connection to 2.2, 12 or 24 VDC and illuminated pushbuttons with maintained or momentary action.

The illuminated pushbuttons are equipped with a snap-action switching system with normally open or normally closed contacts.

The dimensions of the front are 9 x 14 mm, 9 x 9 mm or 9 mm dia. Indicators and illuminated pushbuttons for use with overhanging lenses 14 x 14 mm or 14 mm dia. are also available for recessed front mounting.

Mounting

Mounting from the front through the mounting aperture 8 mm dia. (15.8 x 15.8 mm resp. 16 mm dia. for recessed versions) is assured even with the wiring already attached (mounting dimensions and spacing see pages 440).

The units are provided with soldering or plug-in terminals.

Lenses

The flat lenses, which are made of PMMA, PS, are available in various colours and a transparent version. The surface is nonreflecting (matt).

Illumination

Perfect illumination of the lenses, which can be supplied in various colours, is assured by bipin T1 LEDs in the colours red, yellow and green.

(Compact indicators for connection to 12 or 24 VDC.)

The bipin T1 LED are already integrated in the lenses.

Position Indication

When a switch with maintained action is actuated, the lens remains in the depressed position mechanically. The state of the switch is apparent at all times from the position of the lens.

Number structure

18-XXX.OX5X

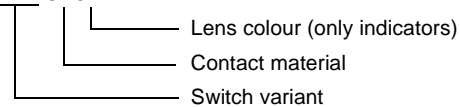

18-9XX.X

Lens

18-9XX.X

Other accessories

Example:

-Illuminated pushbutton; round, momentary action, gold contact; soldering terminals
18-137.035

-Lens red, circular

18-931.2

All dimensions in mm.

We reserve the right to modify technical data.

illuminated-/pushbutton



- 1 lens
- 2 switch housing
- 3 fixing nut

illuminated-/pushbutton, round for flush mounting

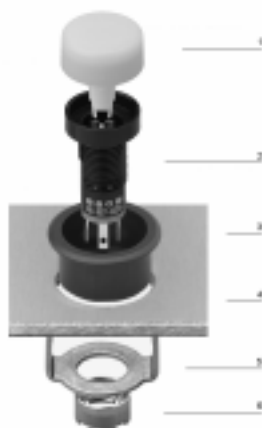

- 1 lens
- 2 switch housing
- 3 front panel
- 4 front ring bezel
- 5 front ring bezel bracket
- 6 fixing nut

indicator



recommended accessories:

	voltage/current	colour of lens	connection method	9 x 14 mm part no.	9 x 9 mm part no.	9 mm dia. part no.	circuit drawing	technical drawing	mounting dimension	components layout	
indicator incl. LED, with built-in series resistor for direct connection	12 VDC/20 mA	green	ST	18-041.0055	18-051.0055	18-031.0055	1	1	1	1	0,002
		red	ST	18-041.0052	18-051.0052	18-031.0052	1	1	1	1	0,002
		yellow	ST	18-041.0054	18-051.0054	18-031.0054	1	1	1	1	0,002
	24 VDC/20 mA	green	ST	18-042.0055	18-052.0055	18-032.0055	1	1	1	1	0,002
		red	ST	18-042.0052	18-052.0052	18-032.0052	1	1	1	1	0,002
		yellow	ST	18-042.0054	18-052.0054	18-032.0054	1	1	1	1	0,002
including LED, without built-in series resistor	2,2 VDC/20 mA	green	ST	18-040.0055	18-050.0055	18-030.0055	1	1	1	1	0,002
		red	ST	18-040.0052	18-050.0052	18-030.0052	1	1	1	1	0,002
		yellow	ST	18-040.0054	18-050.0054	18-030.0054	1	1	1	1	0,002

connection method: ST = soldering terminal; PCB plug-in base page 437

technical drawing as of page 439, mounting dimensions, components layouts as of page 440, circuit drawing as of page 442

illuminated-/pushbutton



recommended accessories:

lens → 435; lens with LED → 435

	switching system	contacts	switching action	connection method	9 x 14 mm part no.	9 x 9 mm part no.	9 mm dia. part no.	circuit drawing	technical drawing	mounting dimension	components layout	
illuminated-/pushbutton	SA	1NC	main	ST	18-248.035	18-258.035	18-238.035	2	2	1	1	0,002
			mom	ST	18-148.035	18-158.035	18-138.035	4	2	1	1	0,002
		1NO	main	ST	18-247.035	18-257.035	18-237.035	3	2	1	1	0,002
			mom	ST	18-147.035	18-157.035	18-137.035	5	2	1	1	0,002

switching system: SA = snap-action switching element

switching action: main = maintained action, mom = momentary action

connection method: ST = soldering terminal; PCB plug-in base page 437

contacts: NC = normally closed, NO = normally open

technical drawing as of page 439, mounting dimensions, components layouts as of page 440, circuit drawing as of page 442

indicator for flush mounting



recommended accessories:

front bezel-set for flush mounting → 436

	voltage/current	colour of lens	connection method	14 x 14 mm part no.	14 mm dia. part no.	circuit drawing	technical drawing	mounting dimension	components layout	
indicator for flush mounting incl. LED, with built-in series resistor for direct connection	12 VDC/20 mA	green	ST	18-081.0055	18-061.0055	1	3	2	2	0,003
		red	ST	18-081.0052	18-061.0052	1	3	2	2	0,003
		yellow	ST	18-081.0054	18-061.0054	1	3	2	2	0,003
	24 VDC/20 mA	green	ST	18-082.0055	18-062.0055	1	3	2	2	0,003
		red	ST	18-082.0052	18-062.0052	1	3	2	2	0,003
		yellow	ST	18-082.0054	18-062.0054	1	3	2	2	0,003
including LED, without built-in series resistor	2,2 VDC/20 mA	green	ST	18-080.0055	18-060.0055	1	3	2	2	0,002
		red	ST	18-080.0052	18-060.0052	1	3	2	2	0,002
		yellow	ST	18-080.0054	18-060.0054	1	3	2	2	0,002

connection method: ST = soldering terminal; PCB plug-in base page 437

[technical drawing as of page 439](#), [mounting dimensions](#), [components layouts as of page 440](#), [circuit drawing as of page 442](#)

illuminated-/pushbutton for flush mounting



recommended accessories:

lens overhanging → 435; lens overhanging with LED → 436

front bezel-set for flush mounting → 436

	switching system	contacts	switching action	connection method	19 mm dia. part no.	19 x 19 mm part no.	circuit drawing	technical drawing	mounting dimension	components layout	
illuminated-/pushbutton for flush mounting	SA	1NC	main	ST	18-268.035	18-288.035	2	4	2	2	0,002
			mom	ST	18-168.035	18-188.035	4	4	2	2	0,002
		1NO	main	ST	18-267.035	18-287.035	3	4	2	2	0,002
			mom	ST	18-167.035	18-187.035	5	4	2	2	0,002

switching system: SA = snap-action switching element

switching action: main = maintained action, mom = momentary action





connection method: ST = soldering terminal; PCB plug-in base page 437

contacts: NC = normally closed, NO = normally open





[technical drawing as of page 439](#), [mounting dimensions](#), [components layouts as of page 440](#), [circuit drawing as of page 442](#)

at front

lens



	shape	lens	colour	 9 x 14 mm part no.	 9 x 9 mm part no.	9 mm dia. part no.		
lens plastic	flat	translucent, matt	black	18-942.0	18-952.0	18-932.0	0,001	
			green	18-942.5	18-952.5	18-932.5	0,001	
			grey	18-942.8	18-952.8	18-932.8	0,001	
			red	18-942.2	18-952.2	18-932.2	0,001	
			white	18-942.9	18-952.9	18-932.9	0,001	
			yellow	18-942.4	18-952.4	18-932.4	0,001	

lens with LED

	shape	lens	colour	 9 x 14 mm part no.	 9 x 9 mm part no.	9 mm dia. part no.		
lens with LED plastic, without built-in series resistor, typ. forward voltage 2.2 VDC/20 mA	flat	translucent, matt	green	18-941.5	18-951.5	18-931.5	0,001	
			red	18-941.2	18-951.2	18-931.2	0,001	
			yellow	18-941.4	18-951.4	18-931.4	0,001	



lens overhanging

for flush mounting

	shape	lens	colour	19 mm dia. part no.	 19 x 19 mm part no.		
lens overhanging plastic	flat	translucent, matt	black	18-962.0	18-982.0	0,001	
			green	18-962.5	18-982.5	0,001	
			grey	18-962.8	18-982.8	0,001	
			red	18-962.2	18-982.2	0,001	
			white	18-962.9	18-982.9	0,001	
			yellow	18-962.4	18-982.4	0,001	



lens overhanging with LED

for flush mounting

	shape	lens	colour	19 mm dia. part no.	\varnothing 19 x 19 mm part no.		
lens overhanging with LED plastic, without built-in series resistor, typ. forward voltage 2.2 VDC/20 mA	flat	translucent, matt	green	18-961.5	18-981.5	0,001	
			red	18-961.2	18-981.2	0,001	
			yellow	18-961.4	18-981.4	0,001	

front bezel-set for flush mounting

for overhanging lenses



	material	colour	19 mm dia. part no.	\varnothing 19 x 19 mm part no.		
front bezel-set for flush mounting for lens round	plastic	black	18-920.3	18-920.2	0,006	
for lens square	plastic	black		18-920.1	0,006	

blind plug

	colour	\varnothing 9 x 9 mm part no.	9 mm dia. part no.		
blind plug	black	19-948.0	19-949.0	0,001	

at back



PCB plug-in base

	for	pin orientation	part no.	technical drawing	components layout		
PCB plug-in base	soldering terminal	axial	18-945	5	3	0,001	 
		right-angled	18-946	6	4	0,001	



technical drawing as of page 439. components layouts as of page 440

assembling

lens remover

	part no.		
lens remover	18-910	0,002	

mounting tool

	part no.		
mounting tool for tightening (or loosening) fixing nuts starting torque fixing nut max. 20 Ncm	19-905	0,011	

actuator with snap-action switching element

switching system

The snap-action switching system was designed for switching low powers in electronic circuits.
Single-break snap-action contact.

material

actuator case

polyamide; colour black

lens

polymethylacrylate PMMA, polycarbonate PC

material of contacts

gold contact on nickel plating

switch rating

10 μ A/100 μ V to 100 mA at 42 VAC/VDC

volume resistance

\leq 100 m Ω starting value (initial)
IEC 512-2, Test 2 b

mechanical characteristics

actuating force

1.4 N

ambient air temperature

-25°C to +65°C
(as per DIN IEC 68-)

connection method

The terminals can be used as soldering terminals.
max.wire diameter: 2 of 0.5 mm²
max.wire ccross-section of stranded cable: 1 x 0.75 mm²
wire cross-section of terminal: 1.6 x 0.4 mm

degree of protection

front as per IEC 529: IP 40

mechanical life

as per IEC 512-5, test 9a
momentary action 2 mio. cycles of operation
maintained action 1 mio. cycles of operation

rebound time

\leq 2.5 ms

resistance to shock

(single impacts, semi-sinusoidal)
50 g for 11 ms as per IEC 68-2-27

resistance to vibration

(sinusoidal) 10 g at 10-2000 Hz, amplitude 0.75 mm as per IEC 512-4-4

starting torque

for fixing nut max. 20 Ncm

storage temperature

-40°C to +80°C
(as per DIN IEC 68-)

travel

2.2 mm \pm 0.2 mm

electrical characteristics

electric strength

500 VAC, 50 Hz, 1 min. between all terminals and earth, as per IEC 512-2-11

electrical life

\geq 500.000 cycles of operation at 30 VDC/100 mA to IEC 512-5, Test 9c

power consumption

20 mA

technical drawing

1 indicator

page 433

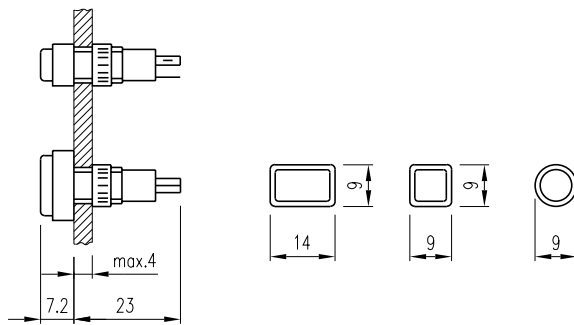

2 illuminated-/pushbutton

page 433

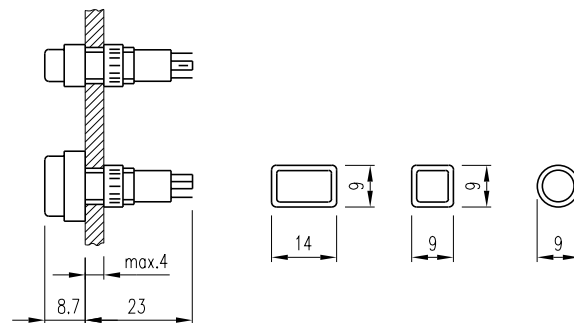

3 indicator for flush mounting

page 434

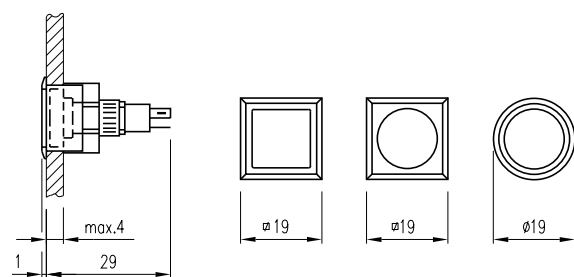

4 illuminated-/pushbutton for flush mounting

page 434

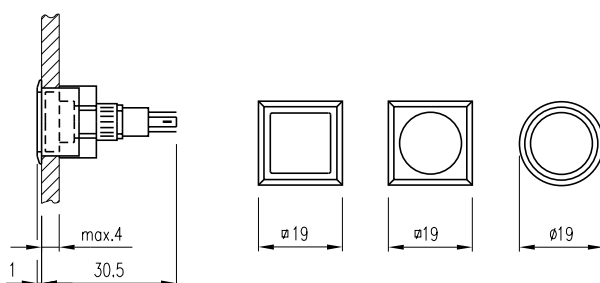

5 PCB plug-in base
page 437

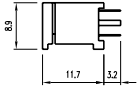

6 PCB plug-in base
page 437

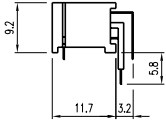

mounting dimension

1 indicator, illuminated-/pushbutton
page 433

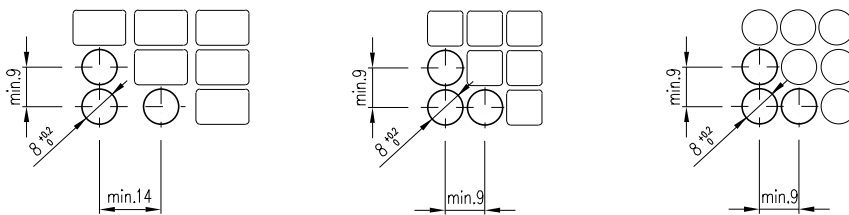

2 indicator for flush mounting, illuminated-/pushbutton for flush mounting
page 434

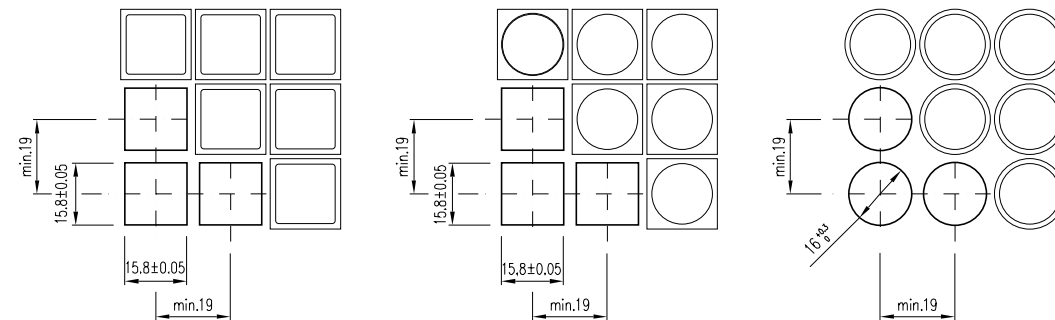

components layouts

1 indicator, illuminated-/pushbutton
page 433



2 indicator for flush mounting, illuminated-/pushbutton for flush mounting
page 434

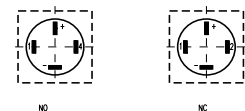

3 PCB plug-in base

page 437

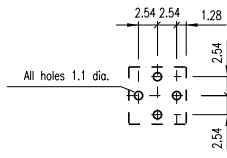

4 PCB plug-in base

page 437

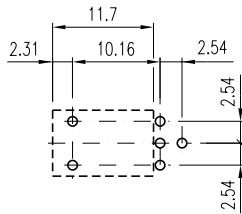

	circuit drawing
1	
2	
3	
4	
5	

Компания «Океан Электроники» предлагает заключение долгосрочных отношений при поставках импортных электронных компонентов на взаимовыгодных условиях!

Наши преимущества:

- Поставка оригинальных импортных электронных компонентов напрямую с производств Америки, Европы и Азии, а так же с крупнейших складов мира;
- Широкая линейка поставок активных и пассивных импортных электронных компонентов (более 30 млн. наименований);
- Поставка сложных, дефицитных, либо снятых с производства позиций;
- Оперативные сроки поставки под заказ (от 5 рабочих дней);
- Экспресс доставка в любую точку России;
- Помощь Конструкторского Отдела и консультации квалифицированных инженеров;
- Техническая поддержка проекта, помощь в подборе аналогов, поставка прототипов;
- Поставка электронных компонентов под контролем ВП;
- Система менеджмента качества сертифицирована по Международному стандарту ISO 9001;
- При необходимости вся продукция военного и аэрокосмического назначения проходит испытания и сертификацию в лаборатории (по согласованию с заказчиком);
- Поставка специализированных компонентов военного и аэрокосмического уровня качества (Xilinx, Altera, Analog Devices, Intersil, Interpoint, Microsemi, Actel, Aeroflex, Peregrine, VPT, Syfer, Eurofarad, Texas Instruments, MS Kennedy, Miteq, Cobham, E2V, MA-COM, Hittite, Mini-Circuits, General Dynamics и др.);

Компания «Океан Электроники» является официальным дистрибьютором и эксклюзивным представителем в России одного из крупнейших производителей разъемов военного и аэрокосмического назначения «JONHON», а так же официальным дистрибьютором и эксклюзивным представителем в России производителя высокотехнологичных и надежных решений для передачи СВЧ сигналов «FORSTAR».



JONHON

«JONHON» (основан в 1970 г.)

Разъемы специального, военного и аэрокосмического назначения:

(Применяются в военной, авиационной, аэрокосмической, морской, железнодорожной, горно- и нефтедобывающей отраслях промышленности)

«FORSTAR» (основан в 1998 г.)

ВЧ соединители, коаксиальные кабели, кабельные сборки и микроволновые компоненты:

(Применяются в телекоммуникациях гражданского и специального назначения, в средствах связи, РЛС, а так же военной, авиационной и аэрокосмической отраслях промышленности).



Телефон: 8 (812) 309-75-97 (многоканальный)

Факс: 8 (812) 320-03-32

Электронная почта: ocean@oceanchips.ru

Web: <http://oceanchips.ru/>

Адрес: 198099, г. Санкт-Петербург, ул. Калинина, д. 2, корп. 4, лит. А