

## **NTC thermistors for temperature measurement**

SMD NTC thermistors,  
EIA case size 0603 (1608), standard series

**Series/Type:** B573\*\*V2  
**Date:** February 2019

### SMD

#### Applications

- Temperature measurement and compensation

#### Features

- Multilayer SMD NTC with inner electrodes
- Nickel barrier termination
- For temperature measurement up to 125 °C
- Excellent long-term aging stability in high temperature environment
- High mechanical robustness
- Short response time
- 100% Pb free
- UL approval (E69802)

#### Options

- Alternative resistance ratings, resistance tolerances and B value tolerances available on request.

#### Delivery mode

Cardboard tape, 180-mm reel (standard);  
330-mm reel (on request)

#### General technical data

|                               |                    |                    |                       |      |
|-------------------------------|--------------------|--------------------|-----------------------|------|
| Operating temperature range   |                    | $T_{op}$           | -55 ... 125           | °C   |
| Max. power                    | (at 25 °C, on PCB) | $P_{25}^{1)}$      | 180                   | mW   |
| Resistance tolerance          |                    | $\Delta R_R / R_R$ | $\pm 1, \pm 3, \pm 5$ | %    |
| Rated temperature             |                    | $T_R$              | 25                    | °C   |
| Dissipation factor            | (on PCB)           | $\delta_{th}^{1)}$ | approx. 3             | mW/K |
| Thermal cooling time constant | (on PCB)           | $\tau_c^{1)}$      | approx. 4             | s    |
| Heat capacity                 |                    | $C_{th}^{1)}$      | approx. 12            | mJ/K |

#### Dimensional drawing



Termination

TNT0396-Y-E

Dimensions in mm  
Approx. weight 6 mg

1) Depends on mounting situation

**SMD**
**Electrical specification and ordering codes**

| $R_{25}$<br>$\Omega$ | $\Delta R_R/R_R$<br>% | No. of R/T<br>characteristic | $B_{25/50}$<br>K | $B_{25/65}$<br>K | $B_{25/100}$<br>K | Ordering code   |
|----------------------|-----------------------|------------------------------|------------------|------------------|-------------------|-----------------|
| 1.0 k                | $\pm 3, \pm 5$        | 8502                         | 3940             | 3980             | 4000 $\pm 3\%$    | B57321V2102+060 |
| 2.2 k                | $\pm 3, \pm 5$        | 8502                         | 3940             | 3980             | 4000 $\pm 3\%$    | B57321V2222+060 |
| 4.7 k                | $\pm 3, \pm 5$        | 8500                         | 3590             | 3635             | 3650 $\pm 3\%$    | B57301V2472+060 |
| 6.8 k                | $\pm 3, \pm 5$        | 8507                         | 4386             | 4455             | 4480 $\pm 3\%$    | B57371V2682+060 |
| 10 k                 | $\pm 1, \pm 3, \pm 5$ | 8509                         | 3380             | 3435             | 3455 $\pm 1\%$    | B57330V2103+260 |
| 10 k                 | $\pm 3, \pm 5$        | 8500                         | 3590             | 3635             | 3650 $\pm 3\%$    | B57301V2103+060 |
| 10 k                 | $\pm 3, \pm 5$        | 8502                         | 3940             | 3980             | 4000 $\pm 3\%$    | B57321V2103+060 |
| 10 k                 | $\pm 3, \pm 5$        | 8507                         | 4386             | 4455             | 4480 $\pm 3\%$    | B57371V2103+060 |
| 22 k                 | $\pm 3, \pm 5$        | 8502                         | 3940             | 3980             | 4000 $\pm 3\%$    | B57321V2223+060 |
| 22 k                 | $\pm 3, \pm 5$        | 8507                         | 4386             | 4455             | 4480 $\pm 3\%$    | B57371V2223+060 |
| 47 k                 | $\pm 3, \pm 5$        | 8502                         | 3940             | 3980             | 4000 $\pm 3\%$    | B57321V2473+060 |
| 47 k                 | $\pm 1, \pm 3, \pm 5$ | 8551                         | 4050             | 4108             | 4131 $\pm 1.5\%$  | B57357V2473+560 |
| 47 k                 | $\pm 3, \pm 5$        | 8551                         | 4050             | 4108             | 4131 $\pm 2\%$    | B57358V2473+560 |
| 47 k                 | $\pm 3, \pm 5$        | 8507                         | 4386             | 4455             | 4480 $\pm 3\%$    | B57371V2473+060 |
| 68 k                 | $\pm 3, \pm 5$        | 8507                         | 4386             | 4455             | 4480 $\pm 3\%$    | B57371V2683+060 |
| 100 k                | $\pm 1, \pm 3, \pm 5$ | 8512                         | 4200             | 4260             | 4282 $\pm 1\%$    | B57350V2104+460 |
| 100 k                | $\pm 3, \pm 5$        | 8552                         | 4250             | 4311             | 4334 $\pm 2\%$    | B57358V2104+360 |
| 100 k                | $\pm 1, \pm 3, \pm 5$ | 8507                         | 4386             | 4455             | 4480 $\pm 1\%$    | B57374V2104+060 |
| 100 k                | $\pm 3, \pm 5$        | 8507                         | 4386             | 4455             | 4480 $\pm 3\%$    | B57371V2104+060 |
| 470 k                | $\pm 3, \pm 5$        | 8507                         | 4386             | 4455             | 4480 $\pm 3\%$    | B57371V2474+060 |

+ = Resistance tolerance

F =  $\pm 1\%$

H =  $\pm 3\%$

J =  $\pm 5\%$

**SMD**
**Reliability data**

SMD NTC thermistors are tested in accordance with IEC 60068. The parts are mounted on a standardized PCB in accordance with IEC 60539-1.

| Test                               | Standard                        | Test conditions   | $\Delta R_{25}/R_{25}$<br>(typical) | Remarks                    |
|------------------------------------|---------------------------------|---|-------------------------------------|----------------------------|
| Storage in dry heat                | IEC<br>60068-2-2<br>JIS C 0021  | Storage at upper category temperature<br>T: (125 ±2) °C<br>t: 1000 h  | < 2%                                |                            |
| Storage in damp heat, steady state | IEC<br>60068-2-78<br>JIS C 0022 | Temperature of air: (40 ±2) °C<br>Relative humidity of air:<br>(93 +2/−3)%<br>Duration: 56 days                                     | < 2%                                |                            |
| Rapid temperature cycling          | IEC<br>60068-2-14<br>JIS C 0025 | Lower test temperature: −55 °C<br>Upper test temperature: 125 °C<br>Number of cycles: 100   | < 2%                                |                            |
| Endurance                          |                                 | $P_{max}$ : 180 mW<br>T: (65 ±2) °C<br>t: 1000 h  | < 2%                                |                            |
| Solderability                      | IEC<br>60068-2-58<br>JIS C 0054 | Solderability:<br>(215 ±3) °C, (3 ±0.3) s<br>(245 ±5) °C, (3 ±0.3) s<br><br>Resistance to soldering heat:<br>(260 ±5) °C, (10 ±1) s |                                     | 95% of terminations wetted |
| Resistance drift after soldering   |                                 | Reflow soldering profile<br>Wave soldering profile  | < 1%                                |                            |

**SMD**
**R/T characteristics**

| R/T No. | <b>8500</b>                     |         | <b>8502</b>                     |         | <b>8507</b>                     |         |
|---------|---------------------------------|---------|---------------------------------|---------|---------------------------------|---------|
| T (°C)  | B <sub>25/100</sub> = 3650 K    |         | B <sub>25/100</sub> = 4000 K    |         | B <sub>25/100</sub> = 4480 K    |         |
|         | R <sub>T</sub> /R <sub>25</sub> | α (%/K) | R <sub>T</sub> /R <sub>25</sub> | α (%/K) | R <sub>T</sub> /R <sub>25</sub> | α (%/K) |
| -55.0   | 63.917                          | 6.8     | 96.158                          | 7.4     | 142.71                          | 7.9     |
| -50.0   | 45.889                          | 6.5     | 66.892                          | 7.1     | 96.913                          | 7.6     |
| -45.0   | 33.344                          | 6.3     | 47.127                          | 6.9     | 66.637                          | 7.4     |
| -40.0   | 24.504                          | 6.1     | 33.606                          | 6.6     | 46.366                          | 7.1     |
| -35.0   | 18.201                          | 5.8     | 24.243                          | 6.4     | 32.629                          | 6.9     |
| -30.0   | 13.657                          | 5.6     | 17.681                          | 6.2     | 23.213                          | 6.7     |
| -25.0   | 10.347                          | 5.5     | 13.032                          | 6.0     | 16.686                          | 6.5     |
| -20.0   | 7.9114                          | 5.3     | 9.702                           | 5.8     | 12.115                          | 6.3     |
| -15.0   | 6.1019                          | 5.1     | 7.2923                          | 5.6     | 8.8803                          | 6.1     |
| -10.0   | 4.7454                          | 4.9     | 5.5314                          | 5.4     | 6.5692                          | 5.9     |
| -5.0    | 3.7198                          | 4.8     | 4.2325                          | 5.3     | 4.9025                          | 5.8     |
| 0.0     | 2.938                           | 4.6     | 3.2657                          | 5.1     | 3.6896                          | 5.6     |
| 5.0     | 2.3372                          | 4.5     | 2.54                            | 4.9     | 2.7994                          | 5.4     |
| 10.0    | 1.8722                          | 4.4     | 1.9907                          | 4.8     | 2.1406                          | 5.3     |
| 15.0    | 1.5096                          | 4.2     | 1.5716                          | 4.7     | 1.6492                          | 5.1     |
| 20.0    | 1.2249                          | 4.1     | 1.2494                          | 4.5     | 1.2798                          | 5.0     |
| 25.0    | 1.0000                          | 4.0     | 1.0000                          | 4.4     | 1.0000                          | 4.9     |
| 30.0    | 0.82111                         | 3.9     | 0.80552                         | 4.3     | 0.78663                         | 4.7     |
| 35.0    | 0.67798                         | 3.8     | 0.65288                         | 4.1     | 0.62277                         | 4.6     |
| 40.0    | 0.56279                         | 3.7     | 0.53229                         | 4.0     | 0.4961                          | 4.5     |
| 45.0    | 0.46958                         | 3.6     | 0.43645                         | 3.9     | 0.39757                         | 4.4     |
| 50.0    | 0.39374                         | 3.5     | 0.35981                         | 3.8     | 0.32044                         | 4.3     |
| 55.0    | 0.33171                         | 3.4     | 0.29819                         | 3.7     | 0.2597                          | 4.1     |
| 60.0    | 0.28073                         | 3.3     | 0.24837                         | 3.6     | 0.21161                         | 4.0     |
| 65.0    | 0.23863                         | 3.2     | 0.20787                         | 3.5     | 0.17331                         | 3.9     |
| 70.0    | 0.2037                          | 3.1     | 0.17479                         | 3.4     | 0.14265                         | 3.8     |
| 75.0    | 0.17459                         | 3.0     | 0.14763                         | 3.3     | 0.11799                         | 3.8     |
| 80.0    | 0.15022                         | 3.0     | 0.12523                         | 3.2     | 0.098035                        | 3.7     |
| 85.0    | 0.12975                         | 2.9     | 0.10667                         | 3.2     | 0.081823                        | 3.6     |
| 90.0    | 0.11247                         | 2.8     | 0.091227                        | 3.1     | 0.068589                        | 3.5     |
| 95.0    | 0.097838                        | 2.8     | 0.078319                        | 3.0     | 0.057735                        | 3.4     |
| 100.0   | 0.085396                        | 2.7     | 0.067488                        | 2.9     | 0.048796                        | 3.3     |
| 105.0   | 0.074781                        | 2.6     | 0.058363                        | 2.9     | 0.041403                        | 3.2     |
| 110.0   | 0.065691                        | 2.6     | 0.050647                        | 2.8     | 0.035263                        | 3.2     |
| 115.0   | 0.057883                        | 2.5     | 0.044098                        | 2.7     | 0.030143                        | 3.1     |
| 120.0   | 0.051153                        | 2.4     | 0.03852                         | 2.7     | 0.025858                        | 3.0     |
| 125.0   | 0.045335                        | 2.4     | 0.033752                        | 2.6     | 0.022258                        | 3.0     |
| 130.0   | 0.040289                        | 2.3     | 0.029663                        | 2.6     | 0.019223                        | 2.9     |
| 135.0   | 0.0359                          | 2.3     | 0.026146                        | 2.5     | 0.016655                        | 2.8     |
| 140.0   | 0.032071                        | 2.2     | 0.023111                        | 2.4     | 0.014476                        | 2.8     |
| 145.0   | 0.028723                        | 2.2     | 0.020484                        | 2.4     | 0.012619                        | 2.7     |
| 150.0   | 0.025786                        | 2.1     | 0.018203                        | 2.3     | 0.011033                        | 2.7     |

**SMD**
**R/T characteristics**

| R/T No. | <b>8509</b>                     |         | <b>8512</b>                     |         | <b>8551</b>                     |         |
|---------|---------------------------------|---------|---------------------------------|---------|---------------------------------|---------|
| T (°C)  | B <sub>25/100</sub> = 3455 K    |         | B <sub>25/100</sub> = 4282 K    |         | B <sub>25/100</sub> = 4131 K    |         |
|         | R <sub>T</sub> /R <sub>25</sub> | α (%/K) | R <sub>T</sub> /R <sub>25</sub> | α (%/K) | R <sub>T</sub> /R <sub>25</sub> | α (%/K) |
| -55.0   | 44.605                          | 5.9     | 130.38                          | 8.0     | 111.73                          | 7.8     |
| -50.0   | 33.281                          | 5.8     | 88.097                          | 7.7     | 76.28                           | 7.5     |
| -45.0   | 25.044                          | 5.6     | 60.444                          | 7.4     | 52.88                           | 7.2     |
| -40.0   | 19.003                          | 5.4     | 42.065                          | 7.1     | 37.187                          | 6.9     |
| -35.0   | 14.536                          | 5.3     | 29.666                          | 6.9     | 26.498                          | 6.7     |
| -30.0   | 11.206                          | 5.1     | 21.185                          | 6.6     | 19.117                          | 6.4     |
| -25.0   | 8.7041                          | 5.0     | 15.307                          | 6.4     | 13.954                          | 6.2     |
| -20.0   | 6.8104                          | 4.8     | 11.183                          | 6.2     | 10.297                          | 6.0     |
| -15.0   | 5.3665                          | 4.7     | 8.2558                          | 6.0     | 7.677                           | 5.8     |
| -10.0   | 4.2576                          | 4.6     | 6.1553                          | 5.8     | 5.780                           | 5.6     |
| -5.0    | 3.4001                          | 4.4     | 4.6324                          | 5.6     | 4.3916                          | 5.4     |
| 0.0     | 2.7326                          | 4.3     | 3.5175                          | 5.4     | 3.3661                          | 5.2     |
| 5.0     | 2.2096                          | 4.2     | 2.6935                          | 5.3     | 2.6014                          | 5.1     |
| 10.0    | 1.7973                          | 4.1     | 2.0792                          | 5.1     | 2.0262                          | 4.9     |
| 15.0    | 1.4703                          | 4.0     | 1.6173                          | 4.9     | 1.5901                          | 4.8     |
| 20.0    | 1.2093                          | 3.9     | 1.2673                          | 4.8     | 1.2567                          | 4.6     |
| 25.0    | 1.0000                          | 3.7     | 1.0000                          | 4.7     | 1.0000                          | 4.5     |
| 30.0    | 0.83113                         | 3.6     | 0.79435                         | 4.5     | 0.8009                          | 4.4     |
| 35.0    | 0.69418                         | 3.6     | 0.63504                         | 4.4     | 0.6454                          | 4.3     |
| 40.0    | 0.58255                         | 3.5     | 0.51079                         | 4.3     | 0.5232                          | 4.1     |
| 45.0    | 0.49112                         | 3.4     | 0.41327                         | 4.2     | 0.42650                         | 4.0     |
| 50.0    | 0.41587                         | 3.3     | 0.33625                         | 4.1     | 0.34959                         | 3.9     |
| 55.0    | 0.35365                         | 3.2     | 0.27507                         | 4.0     | 0.28804                         | 3.8     |
| 60.0    | 0.30197                         | 3.1     | 0.22618                         | 3.9     | 0.23851                         | 3.7     |
| 65.0    | 0.25888                         | 3.0     | 0.18692                         | 3.8     | 0.19844                         | 3.6     |
| 70.0    | 0.22278                         | 3.0     | 0.15521                         | 3.7     | 0.16587                         | 3.5     |
| 75.0    | 0.19243                         | 2.9     | 0.12948                         | 3.6     | 0.13926                         | 3.5     |
| 80.0    | 0.16681                         | 2.8     | 0.10850                         | 3.5     | 0.11742                         | 3.4     |
| 85.0    | 0.1451                          | 2.8     | 0.091301                        | 3.4     | 0.09941                         | 3.3     |
| 90.0    | 0.12663                         | 2.7     | 0.077149                        | 3.3     | 0.08449                         | 3.2     |
| 95.0    | 0.11088                         | 2.6     | 0.065451                        | 3.2     | 0.07209                         | 3.1     |
| 100.0   | 0.097381                        | 2.6     | 0.055740                        | 3.2     | 0.06174                         | 3.1     |
| 105.0   | 0.085788                        | 2.5     | 0.047647                        | 3.1     | 0.05305                         | 3.0     |
| 110.0   | 0.075795                        | 2.4     | 0.040874                        | 3.0     | 0.04575                         | 2.9     |
| 115.0   | 0.067155                        | 2.4     | 0.035186                        | 3.0     | 0.039583                        | 2.9     |
| 120.0   | 0.059663                        | 2.3     | 0.030391                        | 2.9     | 0.034356                        | 2.8     |
| 125.0   | 0.053146                        | 2.3     | 0.026334                        | 2.8     | 0.029912                        | 2.7     |
| 130.0   | 0.047463                        | 2.2     | 0.022890                        | 2.8     | 0.026120                        | 2.7     |
| 135.0   | 0.042493                        | 2.2     | 0.019957                        | 2.7     | 0.022875                        | 2.6     |
| 140.0   | 0.038134                        | 2.1     | 0.017451                        | 2.7     | 0.020089                        | 2.6     |
| 145.0   | 0.034302                        | 2.1     | 0.015303                        | 2.6     | 0.017690                        | 2.5     |
| 150.0   | 0.030925                        | 2.1     | 0.013456                        | 2.5     | 0.015619                        | 2.5     |

**SMD**
**R/T characteristics**

| R/T No. | <b>8552</b>                     |         |        |                                 |         |        |                                 |         |
|---------|---------------------------------|---------|--------|---------------------------------|---------|--------|---------------------------------|---------|
| T (°C)  | B <sub>25/100</sub> = 4334 K    |         | T (°C) | B <sub>25/100</sub> = 4334 K    |         | T (°C) | B <sub>25/100</sub> = 4334 K    |         |
|         | R <sub>T</sub> /R <sub>25</sub> | α (%/K) |        | R <sub>T</sub> /R <sub>25</sub> | α (%/K) |        | R <sub>T</sub> /R <sub>25</sub> | α (%/K) |
| -55.0   | 138.15                          | 8.1     | 15.0   | 1.6266                          | 5.0     | 85.0   | 0.088735                        | 3.4     |
| -50.0   | 92.920                          | 7.8     | 20.0   | 1.2709                          | 4.9     | 90.0   | 0.074831                        | 3.4     |
| -45.0   | 63.468                          | 7.5     | 25.0   | 1.0000                          | 4.7     | 95.0   | 0.063360                        | 3.3     |
| -40.0   | 43.979                          | 7.2     | 30.0   | 0.79218                         | 4.6     | 100.0  | 0.053856                        | 3.2     |
| -35.0   | 30.888                          | 6.9     | 35.0   | 0.63161                         | 4.5     | 105.0  | 0.045950                        | 3.1     |
| -30.0   | 21.969                          | 6.7     | 40.0   | 0.50672                         | 4.3     | 110.0  | 0.039346                        | 3.1     |
| -25.0   | 15.812                          | 6.5     | 45.0   | 0.40894                         | 4.2     | 115.0  | 0.033810                        | 3.0     |
| -20.0   | 11.509                          | 6.2     | 50.0   | 0.33191                         | 4.1     | 120.0  | 0.029151                        | 2.9     |
| -15.0   | 8.4659                          | 6.0     | 55.0   | 0.27087                         | 4.0     | 125.0  | 0.025217                        | 2.9     |
| -10.0   | 6.2899                          | 5.8     | 60.0   | 0.22222                         | 3.9     | 130.0  | 0.021882                        | 2.8     |
| -5.0    | 4.7178                          | 5.7     | 65.0   | 0.18322                         | 3.8     | 135.0  | 0.019047                        | 2.7     |
| 0.0     | 3.5705                          | 5.5     | 70.0   | 0.15181                         | 3.7     | 140.0  | 0.016628                        | 2.7     |
| 5.0     | 2.7255                          | 5.3     | 75.0   | 0.12637                         | 3.6     | 145.0  | 0.014559                        | 2.6     |
| 10.0    | 2.0974                          | 5.2     | 80.0   | 0.10566                         | 3.5     | 150.0  | 0.012782                        | 2.6     |

**SMD**
**Taping and packing**
**1 Taping of SMD NTC thermistors**

Tape and reel packing according to IEC 60286-3.

Tape material: Cardboard or blister, tape width  $8 \pm 0.30$  mm

**2 Reel packing**



KKE0058-I-E

**Dimensions in mm**

|       | 8-mm tape     |               |
|-------|---------------|---------------|
|       | 180-mm reel   | 330-mm reel   |
| A     | 180 $+0/-3$   | 330 $+0/-2.0$ |
| $W_1$ | 8.4 $+1.5/-0$ | 8.4 $+1.5/-0$ |
| $W_2$ | 14.4 max.     | 14.4 max.     |

**Leader, trailer**

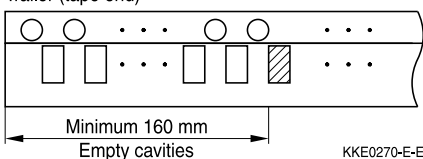
Trailer (tape end)



KKE0270-E-E

Leader



KKE0289-Q-E



**SMD**
**Packing units for discrete chip**

|           |  |  |              |  |  |
|-----------|---|---|--------------|---|--|
| Case size | Chip thickness  | Cardboard tape  | Blister tape | Ø 180-mm reel   | Ø 330-mm reel  |
| inch/mm   | th  | W   | W            | pcs.  | pcs.   |
| 0402/1005 | 0.5 mm  | 8 mm  | –            | 10000   | 50000  |
| 0603/1608 | 0.8 mm  | 8 mm  | 8 mm         | 4000  | 16000  |
| 0805/2012 | 0.8 mm  | –   | 8 mm         | 2000/ 4000  | 16000  |
|           | 1.2 mm  | –   | 8 mm         |   |  |
| 1206/3216 | 0.8 mm  | –   | 8 mm         | 2000  | 12000  |
|           | 1.2 mm  | –   | 8 mm         |   |  |

**3 Packing codes**

The last two digits of the complete ordering code state the packing mode:

| Last two digits |     |                |                     |
|-----------------|-----|----------------|---------------------|
| 60              | SMD | Cardboard tape | 180-mm reel packing |
| 62              | SMD | Blister tape   | 180-mm reel packing |
| 70              | SMD | Cardboard tape | 330-mm reel packing |
| 72              | SMD | Blister tape   | 330-mm reel packing |

**SMD**
**4 Taping of radial leaded NTC thermistors**
**Dimensions and tolerances**

 Lead spacing  $F = 2.5 \text{ mm}$  and  $5.0 \text{ mm}$  (taping to IEC 60286-2)

**Dimensions (mm)**

|            | Lead spacing<br>2.5 mm | Lead spacing<br>5 mm | Tolerance of<br>lead spacing<br>2.5/5 mm | Remarks                                |
|------------|------------------------|----------------------|--|--|
| w          | 11.0                   | 11.5                 | max.                                     |  |
| th         | 5.0                    | 6.0                  | max.                                     |  |
| d          | 0.5/0.6                | 0.5/0.6              | $\pm 0.05$                               |  |
| $P_0$      | 12.7                   | 12.7                 | $\pm 0.3$                                | $\pm 1 \text{ mm}$ / 20 sprocket holes |
| $P_1$      | 5.1                    | 3.85                 | $\pm 0.7$                                |  |
| F          | 2.5                    | 5.0                  | $+0.6/-0.1$                              |  |
| $\Delta h$ | 0                      | 0                    | $\pm 2.0$                                | measured at top of component body      |
| $\Delta p$ | 0                      | 0                    | $\pm 1.3$                                |  |
| W          | 18.0                   | 18.0                 | $\pm 0.5$                                |  |
| $W_0$      | 5.5                    | 5.5                  | min.                                     | peel-off force $\geq 5 \text{ N}$      |
| $W_1$      | 9.0                    | 9.0                  | $+0.75/-0.5$                             |  |
| $W_2$      | 3.0                    | 3.0                  | max.                                     |  |
| H          | 18.0                   | 18.0                 | $+2.0/-0$                                |  |
| $H_0$      | 16.0                   | 16.0                 | $\pm 0.5$                                |  |
| $H_1$      | 32.2                   | 32.2                 | max.                                     |  |
| $D_0$      | 4.0                    | 4.0                  | $\pm 0.2$                                |  |
| t          | 0.9                    | 0.9                  | max.                                     | without wires                          |
| L          | 11.0                   | 11.0                 | max.                                     |  |
| $L_1$      | 4.0                    | 4.0                  | max.                                     |  |

**SMD**
**Types of packing**

Ammo packing



| Ammo type | x  | y   | z   |
|-----------|----|-----|-----|
| I         | 80 | 240 | 210 |

**Packing unit:** 1000 - 2000 pcs./reel

Reel packing

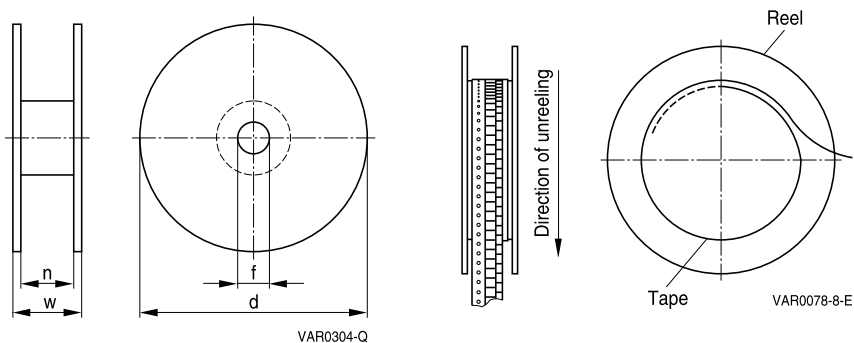
**Packing unit:** 1000 - 2000 pcs./reel

**Reel dimensions (in mm)**

| Reel type | d        | f     | n          | w       |
|-----------|----------|-------|------------|---------|
| I         | 360 max. | 31 ±1 | approx. 45 | 54 max. |

**SMD**
**Cassette packing**

TPT0532-B

**Packing unit:** 1000 - 2000 pcs./cassette

**Bulk packing**

The components are packed in cardboard boxes, the size of which depends on the order quantity.

**SMD**
**5 Packing codes**

The last two digits of the complete ordering code state the packing mode:

| Last two digits                      |                        |                |                     |
|--------------------------------------|------------------------|----------------|---------------------|
| 00, 01, 02, 03,04,<br>05, 06, 07, 08 | –                      | Bulk           | –                   |
| 40, 41                               | –                      | Bulk           | –                   |
| 45                                   | –                      | Bulk           | –                   |
| 50                                   | Radial leads, kinked   | Cardboard tape | Cassette packing    |
| 51                                   | Radial leads, kinked   | Cardboard tape | 360-mm reel packing |
| 52                                   | Radial leads, straight | Cardboard tape | Cassette packing    |
| 53                                   | Radial leads, straight | Cardboard tape | 360-mm reel packing |
| 54                                   | Radial leads, kinked   | Cardboard tape | AMMO packing        |
| 55                                   | Radial leads, straight | Cardboard tape | AMMO packing        |

(If no packing code is indicated, this corresponds to 40)

|            |                 |                                  |
|------------|-----------------|----------------------------------|
| Example 1: | B57164K0102J000 | Bulk                             |
|            | B57164K0102J052 | Cardboard tape, cassette packing |
| Example 2: | B57881S0103F002 | Bulk                             |
|            | B57881S0103F251 | Cardboard tape, reel packing     |

**SMD**
**Mounting instructions**
**1 Soldering**
**1.1 Leaded NTC thermistors**

Leaded thermistors comply with the solderability requirements specified by CECC.

When soldering, care must be taken that the NTC thermistors are not damaged by excessive heat. The following maximum temperatures, maximum time spans and minimum distances have to be observed:

|                          | <i>Dip soldering</i> | <i>Iron soldering</i> |
|--------------------------|----------------------|-----------------------|
| Bath temperature         | max. 260 °C          | max. 360 °C           |
| Soldering time           | max. 4 s             | max. 2 s              |
| Distance from thermistor | min. 6 mm            | min. 6 mm             |

Under more severe soldering conditions the resistance may change.

**1.1.1 Wave soldering**

Temperature characteristic at component terminal with dual wave soldering



## SMD

### 1.2 Leadless NTC thermistors

In case of NTC thermistors without leads, soldering is restricted to devices which are provided with a solderable metallization. The temperature shock caused by the application of hot solder may produce fine cracks in the ceramic, resulting in changes in resistance.

To prevent leaching of the metallization, solder with silver additives or with a low tin content should be used. In addition, soldering methods should be employed which permit short soldering times.

### 1.3 SMD NTC thermistors

SMD NTC thermistors can be provided with a nickel barrier termination or on special request with silver-palladium termination. The use of no-clean solder products is recommended. In any case mild, non-activated fluxes should be used. Flux residues after soldering should be minimized.

- SMD NTCs with AgPd termination are not approved for lead-free soldering.
- Nickel barrier termination



Figure 1  
SMD NTC thermistors, structure of nickel barrier termination

The nickel barrier layer of the silver/nickel/tin termination (see figure 1) prevents leaching of the silver base metallization layer. This allows great flexibility in the selection of soldering parameters.

The tin prevents the nickel layer from oxidizing and thus ensures better wetting by the solder. The nickel barrier termination is tested for all commonly-used soldering methods according to IEC 60068-2-58. Insufficient preheating may cause ceramic cracks. Rapid cooling by dipping in solvent is not recommended.

The following test and process conditions apply for nickel barrier termination.

**SMD**
**1.3.1 Solderability (test to IEC 60068-2-58)**

Preconditioning: Immersion into flux F-SW 32.

 Evaluation criterion: Wetting of soldering areas  $\geq 95\%$ .

| Solder                               | Bath temperature (°C) | Dwell time (s) |
|--------------------------------------|-----------------------|----------------|
| SnPb 60/40                           | 215 $\pm$ 3           | 3 $\pm$ 0.3    |
| SnAg (3.0 ... 4.0), Cu (0.5 ... 0.9) | 245 $\pm$ 3           | 3 $\pm$ 0.3    |

**1.3.2 Resistance to soldering heat (test to IEC 60068-2-58)**

Preconditioning: Immersion into flux F-SW 32.

 Evaluation criterion: Leaching of side edges  $\leq 1/3$ .

| Solder                               | Bath temperature (°C) | Dwell time (s) |
|--------------------------------------|-----------------------|----------------|
| SnPb 60/40                           | 260 $\pm$ 5           | 10 $\pm$ 1     |
| SnAg (3.0 ... 4.0), Cu (0.5 ... 0.9) | 260 $\pm$ 5           | 10 $\pm$ 1     |

**1.3.3 Reflow soldering**

Temperature ranges for reflow soldering acc. to IEC 60068-2-58 recommendations.

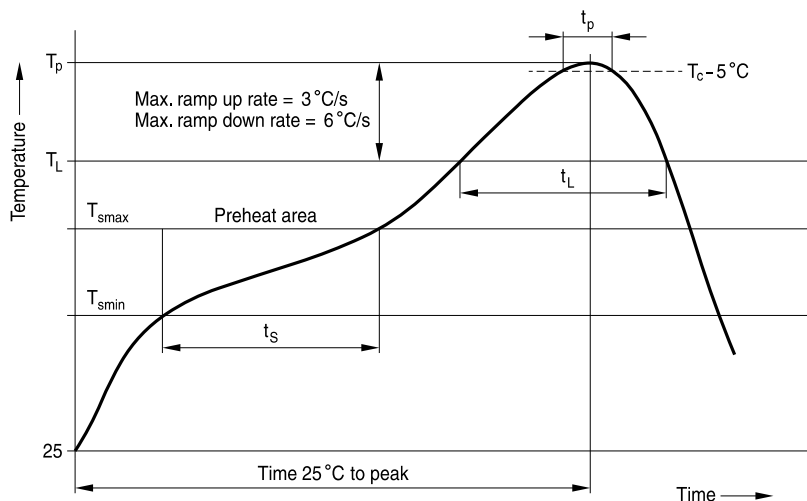

TNT0660-P-E



**SMD**

| Profile feature                |                          | Sn-Pb eutectic assembly         | Pb-free assembly  |
|--------------------------------|--------------------------|---------------------------------|-------------------|
| Preheat and soak               |                          |                                 |                   |
| - Temperature min              | $T_{smin}$               | 100 °C                          | 150 °C            |
| - Temperature max              | $T_{smax}$               | 150 °C                          | 200 °C            |
| - Time                         | $t_{smin}$ to $t_{smax}$ | 60 ... 120 s                    | 60 ... 120 s      |
| Average ramp-up rate           | $T_{smax}$ to $T_p$      | 3 °C/ s max.                    | 3 °C/ s max.      |
| Liquidous temperature          | $T_L$                    | 183 °C                          | 217 °C            |
| Time at liquidous              | $t_L$                    | 40 ... 150 s                    | 40 ... 150 s      |
| Peak package body temperature  | $T_p$                    | 215 °C ... 260 °C <sup>1)</sup> | 235 °C ... 260 °C |
| Time above ( $T_p - 5$ °C)     | $t_p$                    | 10 ... 40 s                     | 10 ... 40 s       |
| Average ramp-down rate         | $T_p$ to $T_{smax}$      | 6 °C/ s max.                    | 6 °C/ s max.      |
| Time 25 °C to peak temperature |                          | max. 8 minutes                  | max. 8 minutes    |

1) Depending on package thickness.

**Notes:** All temperatures refer to topside of the package, measured on the package body surface.

Number of reflow cycles: 3

Iron soldering should be avoided, hot air methods are recommended for repair purposes.

**Solder joint profiles for silver/nickel/tin terminations**

Good solder joint

TNT0565-G-E



Too much solder  
Pad geometry too large

KKE0071-A-E



Poor wetting

KKE0072-I-E

**SMD**
**1.3.4 Recommended geometry of solder pads**

Recommended maximum dimensions (mm)

| Case size<br>inch/mm | A   | B   | C   |
|----------------------|-----|-----|-----|
| 0402/1005            | 0.6 | 0.6 | 1.7 |
| 0603/1608            | 1.0 | 1.0 | 3.0 |
| 0805/2012            | 1.3 | 1.2 | 3.4 |
| 1206/3216            | 1.8 | 1.2 | 4.5 |

**2 Conductive adhesion**

An alternative to soldering for silver-palladium terminated components is the gluing of thermistors with conductive adhesives. The benefit of this method is that it involves no thermal stress. The adhesives used must be chemically inert.

**3 Clamp contacting**

Pressure contacting by means of clamps is particularly suitable for applications involving frequent switching and high turn-on powers.

**4 Robustness of terminations (leaded types)**

The leads meet the requirements of IEC 60068-2-21. They may not be bent closer than 4 mm from the solder joint on the thermistor body or from the point at which they leave the feed-throughs. During bending, any mechanical stress at the outlet of the leads must be removed. The bending radius should be at least 0.75 mm.

**SMD**

Tensile strength: Test Ua1:

Value of applied force for Ua1 test:

| Diameter (d) of corresponding round leads | Force with tolerance of $\pm 10\%$ |
|---|------------------------------------|
| $\varnothing \leq 0.25$ mm                | 1.0 N                              |
| $0.25 < \varnothing \leq 0.35$ mm         | 2.5 N                              |
| $0.35 < \varnothing \leq 0.50$ mm         | 5.0 N                              |
| $0.50 < \varnothing \leq 0.80$ mm         | 10.0 N                             |

Bending strength: Test Ub:

Two 90°-bends in opposite directions

Value of applied force for Ub test:

| Diameter (d) of corresponding round leads | Force with tolerance of $\pm 10\%$ |
|---|------------------------------------|
| $\varnothing \leq 0.25$ mm                | 0.5 N                              |
| $0.25 < \varnothing \leq 0.35$ mm         | 1.25 N                             |
| $0.35 < \varnothing \leq 0.50$ mm         | 2.5 N                              |
| $0.50 < \varnothing \leq 0.80$ mm         | 5 N                                |

Torsional strength: Test Uc: severity 2

The lead is bent by 90° at a distance of 6 to 6.5 mm from the thermistor body.

The bending radius of the leads should be approx. 0.75 mm. Two torsions of 180° each (severity 2).

When subjecting leads to mechanical stress, the following should be observed:

*Tensile stress on leads*

During mounting and operation tensile forces on the leads are to be avoided.

*Bending of leads*

Bending of the leads directly on the thermistor body is not permissible.

A lead may be bent at a minimum distance of twice the wire's diameter +4 mm from the solder joint on the thermistor body. During bending the wire must be mechanically relieved at its outlet. The bending radius should be at least 0.75 mm.

## SMD

### 5 Sealing and potting

Sealing or potting processes can affect the reliability of the component.

When thermistors are sealed, potted or overmolded, there must be no mechanical stress caused by thermal expansion during the production process (curing / overmolding process) and during later operation. The upper category temperature of the thermistor must not be exceeded. Ensure that the materials used (sealing / potting compound and plastic material) are chemically neutral. As thermistors are temperature sensitive components it should be considered that molding can affect the thermal surrounding and may influence e.g. the response time.

Extensive testing is encouraged in order to determine whether overmolding or potting influences the functionality and/ or reliability of the component.

### 6 Cleaning

Cleaning processes can affect the reliability of the component.

If cleaning is necessary, mild cleaning agents are recommended. Cleaning agents based on water are not allowed. Washing processes may damage the product due to the possible static or cyclic mechanical loads (e.g. ultrasonic cleaning). They may cause cracks which might lead to reduced reliability and/ or lifetime.

### 7 Storage

In order to maintain their solderability, thermistors must be stored in a non-corrosive atmosphere. Humidity, temperature and container materials are critical factors.

Do not store SMDs where they are exposed to heat or direct sunlight. Otherwise, the packing material may be deformed or SMDs may stick together, causing problems during mounting. After opening the factory seals, such as polyvinyl-sealed packages, use the SMDs as soon as possible.

The components should be left in the original packing. Touching the metallization of unsoldered thermistors may change their soldering properties.

Storage temperature: –25 °C up to 45 °C

Relative humidity (without condensation): ≤75% annual mean

<95%, maximum 30 days per annum

Solder the thermistors listed in this data book after shipment from TDK within the time specified:

SMDs with AgPd termination: 6 months

SMDs with nickel barrier termination: 12 months

Leadless components: 12 months

Leaded components: 24 months

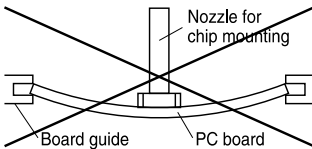
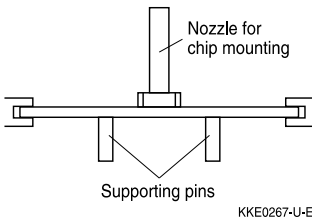
**SMD**
**8 Placement and orientation of SMD NTC thermistors on PCB**
**a) Component placement**
**Incorrect**

**Correct**

It is recommended that the PC board should be held by means of some adequate supporting pins such as shown left to prevent the SMDs from being damaged or cracked.

**b) Cracks**

SMDs located near an easily warped area

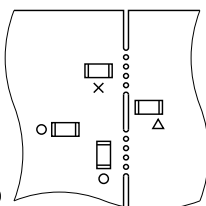
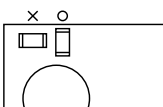
SMD breakage probability due to stress at a breakaway



O = correct  
 X = incorrect  
 Δ = incorrect  
 (under certain conditions)

KKE0268-3-E

When placing a component near an area which is apt to bend or a grid groove on the PC board, it is advisable to have both electrodes subjected to uniform stress, or to position the component's electrodes at right angles to the grid groove or bending line (see c) Component orientation).

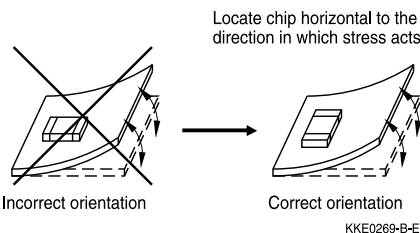
**c) Component orientation**

Choose a mounting position that minimizes the stress imposed on the chip during flexing or bending of the board.

## SMD

### Cautions and warnings

#### General

See "Important notes" at the end of this document.

#### Storage

- Store thermistors only in original packaging. Do not open the package prior to processing.
- Storage conditions in original packaging: storage temperature  $-25\text{ }^{\circ}\text{C} \dots +45\text{ }^{\circ}\text{C}$ , relative humidity  $\leq 75\%$  annual mean,  $< 95\%$  maximum 30 days per annum, dew precipitation is inadmissible.
- Do not store thermistors where they are exposed to heat or direct sunlight. Otherwise, the packing material may be deformed or components may stick together, causing problems during mounting.
- Avoid contamination of thermistor surface during storage, handling and processing.
- Avoid storage of thermistors in harmful environments like corrosive gases ( $\text{SO}_x$ , Cl etc).
- Use the components as soon as possible after opening the original packaging.
- Solder thermistors within the time specified after shipment from TDK.  
For leaded components this is 24 months, for SMD components with nickel barrier termination 12 months, for leadless components this is 12 months, for SMD components with AgPd termination 6 months.

#### Handling

- NTC thermistors must not be dropped. Chip-offs or any other damage must not be caused during handling of NTCs.
- Do not touch components with bare hands. Gloves are recommended.
- Avoid contamination of thermistor surface during handling.
- Washing processes may damage the product due to the possible static or cyclic mechanical loads (e.g. ultrasonic cleaning). They may cause cracks to develop on the product and its parts, which might lead to reduced reliability or lifetime.

#### Bending / twisting leads

- A lead (wire) may be bent at a minimum distance of twice the wire's diameter plus 4 mm from the component head or housing. When bending ensure the wire is mechanically relieved at the component head or housing. The bending radius should be at least 0.75 mm.

#### Soldering

- Use resin-type flux or non-activated flux.
- Insufficient preheating may cause ceramic cracks.
- Rapid cooling by dipping in solvent is not recommended.
- Complete removal of flux is recommended.

SMD**Mounting**

- Ensure that no thermo-mechanical stress occurs due to production processes (curing or overmolding processes) when thermistors are sealed, potted or overmolded or during their subsequent operation. The maximum temperature of the thermistor must not be exceeded. Ensure that the materials used (sealing/potting compound and plastic material) are chemically neutral.
- Electrodes/contacts must not be scratched or damaged before/during/after the mounting process.
- Contacts and housing used for assembly with the thermistor must be clean before mounting.
- Ensure that adjacent materials are designed for operation at temperatures comparable to the surface temperature of the thermistor. Be sure that surrounding parts and materials can withstand the temperature.
- Avoid contamination of the thermistor surface during processing.
- The connections of sensors (e.g. cable end, wire end, plug terminal) may only be exposed to an environment with normal atmospheric conditions.
- Tensile forces on cables or leads must be avoided during mounting and operation.
- Bending or twisting of cables or leads directly on the thermistor body is not permissible.
- Avoid using chemical substances as mounting aids. It must be ensured that no water or other liquids enter the NTC thermistors (e.g. through plug terminals). In particular, water based substances (e.g. soap suds) must not be used as mounting aids for sensors.
- The use of no-clean solder products is recommended. In any case mild, non-activated fluxes should be used. Flux residues after soldering should be minimized.

**Operation**

- Use thermistors only within the specified operating temperature range.
- Use thermistors only within the specified power range.
- Environmental conditions must not harm the thermistors. Only use the thermistors under normal atmospheric conditions or within the specified conditions.
- Contact of NTC thermistors with any liquids and solvents shall be prevented. It must be ensured that no water enters the NTC thermistors (e.g. through plug terminals). For measurement purposes (checking the specified resistance vs. temperature), the component must not be immersed in water but in suitable liquids (e.g. perfluoropolyethers such as Galden).
- Avoid dewing and condensation unless thermistor is specified for these conditions.
- Bending or twisting of cables and/or wires is not permissible during operation of the sensor in the application.
- Be sure to provide an appropriate fail-safe function to prevent secondary product damage caused by malfunction.

This listing does not claim to be complete, but merely reflects the experience of TDK.

SMD**Display of ordering codes for TDK Electronics products**

The ordering code for one and the same product can be represented differently in data sheets, data books, other publications, on the company website, or in order-related documents such as shipping notes, order confirmations and product labels. The varying representations of the ordering codes are due to different processes employed and do not affect the specifications of the respective products.

Detailed information can be found on the Internet under [www.tdk-electronics.tdk.com/orderingcodes](http://www.tdk-electronics.tdk.com/orderingcodes).



**SMD**
**Symbols and terms**

| Symbol              | English  | German  |
|---------------------|--|---|
| A                   | Area   | Fläche  |
| AWG                 | American Wire Gauge  | Amerikanische Norm für Drahtquerschnitte                                  |
| B                   | B value  | B-Wert  |
| B <sub>25/100</sub> | B value determined by resistance measurement at 25 °C and 100 °C         | B-Wert, ermittelt durch Widerstandsmessungen bei 25 °C und 100 °C         |
| C <sub>th</sub>     | Heat capacitance   | Wärmekapazität  |
| I                   | Current  | Strom   |
| N                   | Number (integer)   | Anzahl (ganzzahliger Wert)  |
| P <sub>25</sub>     | Maximum power at 25 °C   | Maximale Leistung bei 25 °C   |
| P <sub>diss</sub>   | Power dissipation  | Verlustleistung   |
| P <sub>el</sub>     | Electrical power   | Elektrische Leistung  |
| P <sub>max</sub>    | Maximum power within stated temperature range                            | Maximale Leistung im angegebenen Temperaturbereich                        |
| $\Delta R_B/R_B$    | Resistance tolerance caused by spread of B value                         | Widerstandstoleranz, die durch die Streuung des B-Wertes verursacht wird  |
| R <sub>ins</sub>    | Insulation resistance  | Isolationswiderstand  |
| R <sub>P</sub>      | Parallel resistance  | Parallelwiderstand  |
| R <sub>R</sub>      | Rated resistance   | Nennwiderstand  |
| $\Delta R_R/R_R$    | Resistance tolerance   | Widerstandstoleranz   |
| R <sub>S</sub>      | Series resistance  | Serienwiderstand  |
| R <sub>T</sub>      | Resistance at temperature T (e.g. R <sub>25</sub> = resistance at 25 °C) | Widerstand bei Temperatur T (z.B. R <sub>25</sub> = Widerstand bei 25 °C) |
| T                   | Temperature  | Temperatur  |
| $\Delta T$          | Temperature tolerance  | Temperaturtoleranz  |
| t                   | Time   | Zeit  |
| T <sub>A</sub>      | Ambient temperature  | Umgebungstemperatur   |
| T <sub>max</sub>    | Upper category temperature   | Obere Grenztemperatur (Kategorietemperatur)                               |
| T <sub>min</sub>    | Lower category temperature   | Untere Grenztemperatur (Kategorietemperatur)                              |
| T <sub>op</sub>     | Operating temperature  | Betriebstemperatur  |
| T <sub>R</sub>      | Rated temperature  | Nenntemperatur  |
| T <sub>surf</sub>   | Surface temperature  | Oberflächentemperatur   |
| V                   | Voltage  | Spannung  |
| V <sub>ins</sub>    | Insulation test voltage  | Isolationsprüfspannung  |
| V <sub>op</sub>     | Operating voltage  | Betriebsspannung  |
| V <sub>test</sub>   | Test voltage   | Prüfspannung  |

**SMD**

| Symbol        | English                       | German                         |
|---------------|-------------------------------|--------------------------------|
| $\alpha$      | Temperature coefficient       | Temperaturkoeffizient          |
| $\Delta$      | Tolerance, change             | Toleranz, Änderung             |
| $\delta_{th}$ | Dissipation factor            | Wärmeleitwert                  |
| $\tau_c$      | Thermal cooling time constant | Thermische Abkühlzeitkonstante |
| $\tau_a$      | Thermal time constant         | Thermische Zeitkonstante       |

**Abbreviations / Notes**

| Symbol            | English  | German  |
|-------------------|--|---|
| <u><b>SMD</b></u> | Surface-mounted devices  | Oberflächenmontierbares Bauelement  |
| *                 | To be replaced by a number in ordering codes, type designations etc.   | Platzhalter für Zahl im Bestellnummerncode oder für die Typenbezeichnung.   |
| +                 | To be replaced by a letter.<br>All dimensions are given in mm.<br>The commas used in numerical values denote decimal points. | Platzhalter für einen Buchstaben.<br>Alle Maße sind in mm angegeben.<br>Verwendete Kommas in Zahlenwerten bezeichnen Dezimalpunkte. |

## Important notes

The following applies to all products named in this publication:

1. Some parts of this publication contain **statements about the suitability of our products for certain areas of application**. These statements are based on our knowledge of typical requirements that are often placed on our products in the areas of application concerned. We nevertheless expressly point out **that such statements cannot be regarded as binding statements about the suitability of our products for a particular customer application**. As a rule, we are either unfamiliar with individual customer applications or less familiar with them than the customers themselves. For these reasons, it is always ultimately incumbent on the customer to check and decide whether a product with the properties described in the product specification is suitable for use in a particular customer application.
2. We also point out that **in individual cases, a malfunction of electronic components or failure before the end of their usual service life cannot be completely ruled out in the current state of the art, even if they are operated as specified**. In customer applications requiring a very high level of operational safety and especially in customer applications in which the malfunction or failure of an electronic component could endanger human life or health (e.g. in accident prevention or lifesaving systems), it must therefore be ensured by means of suitable design of the customer application or other action taken by the customer (e.g. installation of protective circuitry or redundancy) that no injury or damage is sustained by third parties in the event of malfunction or failure of an electronic component.
3. **The warnings, cautions and product-specific notes must be observed.**
4. In order to satisfy certain technical requirements, **some of the products described in this publication may contain substances subject to restrictions in certain jurisdictions (e.g. because they are classed as hazardous)**. Useful information on this will be found in our Material Data Sheets on the Internet ([www.tdk-electronics.tdk.com/material](http://www.tdk-electronics.tdk.com/material)). Should you have any more detailed questions, please contact our sales offices.
5. We constantly strive to improve our products. Consequently, **the products described in this publication may change from time to time**. The same is true of the corresponding product specifications. Please check therefore to what extent product descriptions and specifications contained in this publication are still applicable before or when you place an order. We also **reserve the right to discontinue production and delivery of products**. Consequently, we cannot guarantee that all products named in this publication will always be available. The aforementioned does not apply in the case of individual agreements deviating from the foregoing for customer-specific products.
6. Unless otherwise agreed in individual contracts, **all orders are subject to our General Terms and Conditions of Supply**.

## Important notes

7. **Our manufacturing sites serving the automotive business apply the IATF 16949 standard.** The IATF certifications confirm our compliance with requirements regarding the quality management system in the automotive industry. Referring to customer requirements and customer specific requirements (“CSR”) TDK always has and will continue to have the policy of respecting individual agreements. Even if IATF 16949 may appear to support the acceptance of unilateral requirements, we hereby like to emphasize that **only requirements mutually agreed upon can and will be implemented in our Quality Management System.** For clarification purposes we like to point out that obligations from IATF 16949 shall only become legally binding if individually agreed upon.
8. The trade names EPCOS, CeraCharge, CeraDiode, CeraLink, CeraPad, CeraPlas, CSMP, CTVS, DeltaCap, DigiSiMic, ExoCore, FilterCap, FormFit, LeaXield, MiniBlue, MiniCell, MKD, MKK, MotorCap, PCC, PhaseCap, PhaseCube, PhaseMod, PhiCap, PowerHap, PQSine, PQvar, SIFERRIT, SIFI, SIKOREL, SilverCap, SIMDAD, SiMic, SIMID, SineFormer, SIOV, ThermoFuse, WindCap are **trademarks registered or pending** in Europe and in other countries. Further information will be found on the Internet at [www.tdk-electronics.tdk.com/trademarks](http://www.tdk-electronics.tdk.com/trademarks).

Release 2018-10

# Mouser Electronics

Authorized Distributor

Click to View Pricing, Inventory, Delivery & Lifecycle Information:

## EPCOS / TDK:

[B57321V2102H060](#) [B57321V2222H060](#) [B57301V2472H060](#) [B57321V2103H060](#) [B57321V2473H060](#)  
[B57301V2472J060](#) [B57321V2103J060](#) [B57321V2223J060](#) [B57371V2104J060](#) [B57371V2474J060](#)  
[B57321V2223H060](#) [B57371V2103H060](#) [B57371V2103J060](#) [B57371V2104H060](#) [B57371V2223H060](#)  
[B57371V2223J060](#) [B57371V2473H060](#) [B57371V2473J060](#) [B57371V2474H060](#) [B57371V2682H060](#)  
[B57371V2682J060](#) [B57371V2683H060](#) [B57371V2683J060](#) [B57321V2102J060](#) [B57321V2473J060](#)  
[B57330V2103J260](#) [B57330V2103F260](#) [B57321V2222J060](#) [B57374V2104F060](#) [B57330V2103H260](#)  
[B57301V2103J060](#) [B57374V2104H060](#) [B57301V2103H060](#) [B57358V2473J560](#) [B57357V2473F560](#)  
[B57350V2104F460](#) [B57374V2104J060](#) [B57357V2473J560](#) [B57358V2473H560](#) [B57357V2473H560](#)  
[B57358V2104H360](#) [B57350V2104H460](#) [B57350V2104J460](#) [B57358V2104J360](#)

Компания «Океан Электроники» предлагает заключение долгосрочных отношений при поставках импортных электронных компонентов на взаимовыгодных условиях!

Наши преимущества:

- Поставка оригинальных импортных электронных компонентов напрямую с производств Америки, Европы и Азии, а так же с крупнейших складов мира;
- Широкая линейка поставок активных и пассивных импортных электронных компонентов (более 30 млн. наименований);
- Поставка сложных, дефицитных, либо снятых с производства позиций;
- Оперативные сроки поставки под заказ (от 5 рабочих дней);
- Экспресс доставка в любую точку России;
- Помощь Конструкторского Отдела и консультации квалифицированных инженеров;
- Техническая поддержка проекта, помощь в подборе аналогов, поставка прототипов;
- Поставка электронных компонентов под контролем ВП;
- Система менеджмента качества сертифицирована по Международному стандарту ISO 9001;
- При необходимости вся продукция военного и аэрокосмического назначения проходит испытания и сертификацию в лаборатории (по согласованию с заказчиком);
- Поставка специализированных компонентов военного и аэрокосмического уровня качества (Xilinx, Altera, Analog Devices, Intersil, Interpoint, Microsemi, Actel, Aeroflex, Peregrine, VPT, Syfer, Eurofarad, Texas Instruments, MS Kennedy, Miteq, Cobham, E2V, MA-COM, Hittite, Mini-Circuits, General Dynamics и др.);

Компания «Океан Электроники» является официальным дистрибьютором и эксклюзивным представителем в России одного из крупнейших производителей разъемов военного и аэрокосмического назначения «JONHON», а так же официальным дистрибьютором и эксклюзивным представителем в России производителя высокотехнологичных и надежных решений для передачи СВЧ сигналов «FORSTAR».



## JONHON

«JONHON» (основан в 1970 г.)

Разъемы специального, военного и аэрокосмического назначения:

(Применяются в военной, авиационной, аэрокосмической, морской, железнодорожной, горно- и нефтедобывающей отраслях промышленности)

«FORSTAR» (основан в 1998 г.)

ВЧ соединители, коаксиальные кабели,  
кабельные сборки и микроволновые компоненты:

(Применяются в телекоммуникациях гражданского и специального назначения, в средствах связи, РЛС, а так же военной, авиационной и аэрокосмической отраслях промышленности).



Телефон: 8 (812) 309-75-97 (многоканальный)

Факс: 8 (812) 320-03-32

Электронная почта: [ocean@oceanchips.ru](mailto:ocean@oceanchips.ru)

Web: <http://oceanchips.ru/>

Адрес: 198099, г. Санкт-Петербург, ул. Калинина, д. 2, корп. 4, лит. А