

DESCRIPTION

The MP2637A is a highly-integrated, flexible, switch-mode battery charger with system power path management designed for single-cell Li-ion or Li-polymer batteries for use in a wide range of applications.

The MP2637A can operate in both charge mode and boost mode to allow for full system and battery power management.

When the input power is present, the MP2637A operates in charge mode. The MP2637A detects the battery voltage automatically and charges the battery in three phases: trickle current, constant current, and constant voltage. Other features include charge termination and auto-recharge. The MP2637A also integrates both input current limit and input voltage regulation to manage the input power and meet the system power demand priority.

In the absence of an input source, the MP2637A switches to boost mode through MODE to power the SYS pins from the battery. The OLIM pin programs the output current limit in boost mode. The MP2637A also allows for output short-circuit protection (SCP) to disconnect the battery completely from the load in the event of a short-circuit fault. Normal operation resumes once the short-circuit fault is removed. The MP2637A provides full operating status indication to distinguish charge mode from boost mode.

To guarantee safe operation, the MP2637A limits the die temperature to a preset value of 120°C. Other safety features include input over-voltage protection (OVP), battery over-voltage protection (OVP), thermal shutdown, battery temperature monitoring, and a programmable timer to prevent prolonged charging of a dead battery.

The MP2637A is available in a QFN-24 (4mmx4mm) package.

FEATURES

- Up to 16V Sustainable Input Voltage
- 4.5V to 6V Operating Input Voltage Range
- Power Management Function, Integrated Input Current Limit, Input Voltage Regulation
- Up to 2.5A Programmable Charge Current
- Trickle-Charge Function
- Selectable 4.20V/4.055V Charge Voltage with 0.5% Accuracy
- Negative Temperature Coefficient Pin (NTC) for Battery Temperature Monitoring
- Programmable Timer Back-Up Protection
- Thermal Regulation and Thermal Shutdown
- Internal Battery Reverse Leakage Blocking
- Integrated Over-Voltage Protection (OVP) and Over-Current Protection (OCP) for Pass-Through Path
- Reverse Boost Operation Mode for System Power
- Up to 2.4A Programmable Output Current Limit for Boost Mode
- Integrated Short-Circuit Protection (SCP) and Output Over-Voltage Protection (OVP) for Boost Mode
- Available in a QFN-24 (4mmx4mm) Package

APPLICATIONS

- Sub-Battery Applications
- Power-Bank Applications for Smartphones, Tablet, and Other Portable Devices

All MPS parts are lead-free, halogen-free, and adhere to the RoHS directive. For MPS green status, please visit the MPS website under Quality Assurance. "MPS" and "The Future of Analog IC Technology" are registered trademarks of Monolithic Power Systems, Inc.

TYPICAL APPLICATION

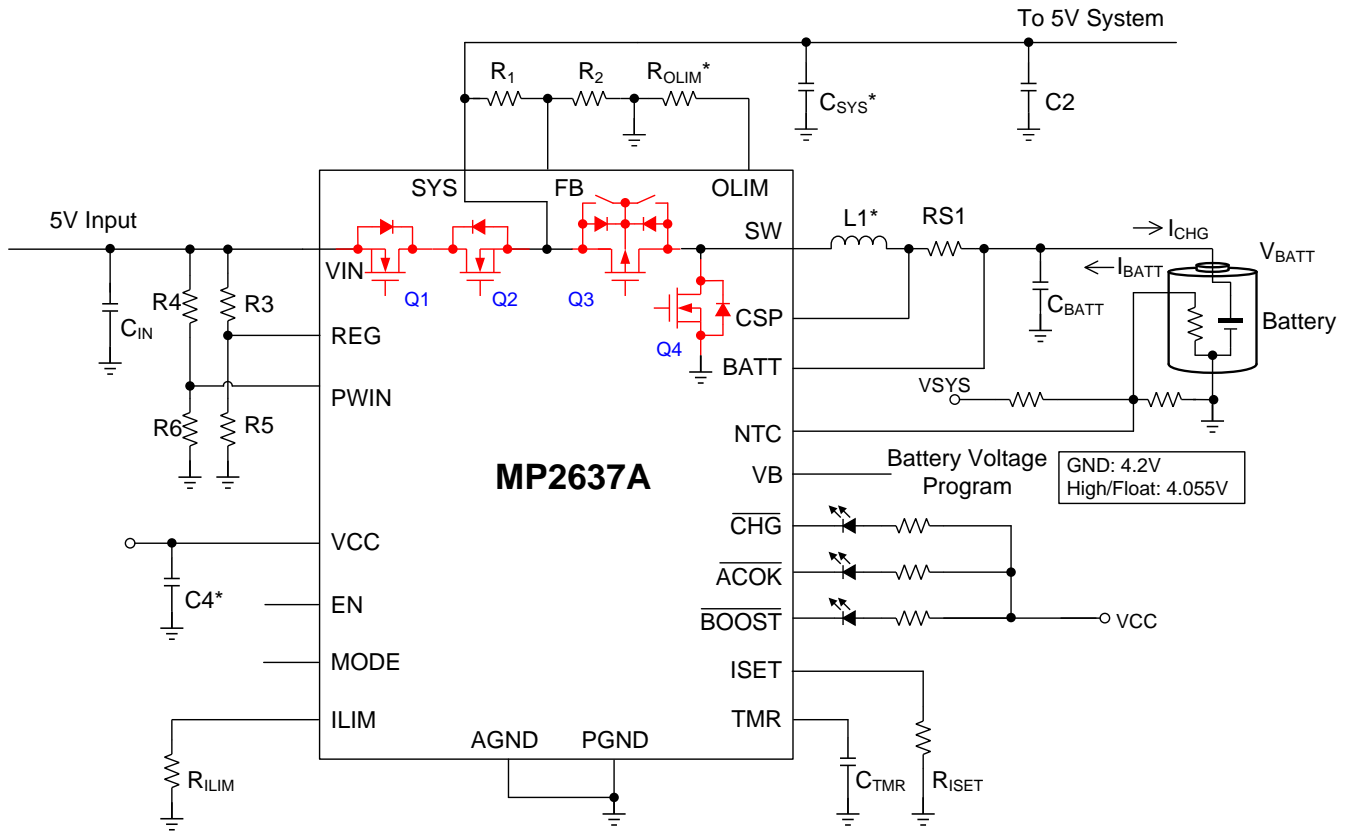

***NOTES:**

1. R_{OLIM} cannot be lower than 47.5k Ω . R_{OLIM} is for the boost output current loop setting. Refer to the Application Information section on page 31 for details.
2. Place C_{SYS} as close to SYS and PGND as possible. The capacitor is recommended to be at least 22 μ F. $C_{SYS} + C2$ should not be less than 44 μ F. Ceramic capacitors are recommended; E-caps are not recommended.
3. The VCC cap should not exceed 100nF (recommend 47nF or 100nF).
4. The inductor should not exceed 2.2 μ H (recommend 1.5 μ H or 2.2 μ H).

Table 1: Operation Mode

Power Source		MODE	EN	Operating Mode	$\overline{\text{ACOK}}$	Q1, Q2	Q3	Q4
VIN	PWIN							
$V_{IN} > V_{BATT} + 300\text{mV}$	$0.8\text{V} < P_{WIN} < 1.15\text{V}$	X	Low	Only pass-through mode	Low	On	Off	Off
			High	Charging mode		On	SW	SW
X	$P_{WIN} < 0.8\text{V}$ or $P_{WIN} > 1.15\text{V}$	High	X	Boost discharge mode	High	Off	SW	SW
$V_{IN} < V_{BATT} + 300\text{mV}$	X							
X	$P_{WIN} < 0.8\text{V}$ or $P_{WIN} > 1.15\text{V}$	Low	X	SYS force-off mode	High	Off	Off	Off
$V_{IN} < 2\text{V}$	X	Low	X	Sleep mode	High	Off	Off	Off

X: does not matter
 On: fully turn on
 Off: fully off
 SW: switching

ORDERING INFORMATION

Part Number*	Package	Top Marking
MP2637AGR	QFN-24 (4mmx4mm)	See Below

* For Tape & Reel, add suffix -Z (e.g. MP2637AGR-Z)

TOP MARKING

MPSYWW

M2637A

LLLLLL

MPS: MPS prefix
 Y: Year code
 WW: Week code
 M2637A: First six digits of the part number
 LLLLLL: Lot number

PACKAGE REFERENCE

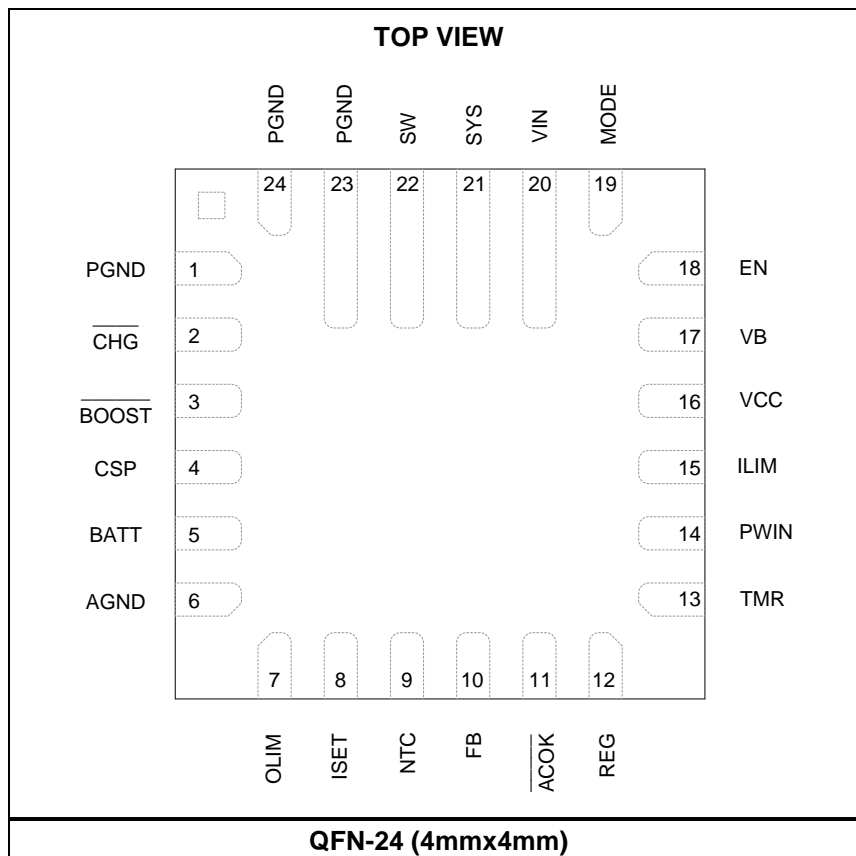

ABSOLUTE MAXIMUM RATINGS (1)

V _{VIN}	-0.3V to 20V
SYS	-0.3V to 6.5V
SW	0.3V (-2V for <20ns) to 6.5V (8.5V for <20ns)
BATT	-0.3V to 6.5V
ACOK, CHG, BOOST	-0.3V to 6.5V
All other pins	-0.3V to 6.5V
Junction temperature	150°C
Lead temperature	260°C
Continuous power dissipation (T _A = +25°C) (2)	2.97W
Junction temperature	150°C
Storage temperature	-65°C to +150°C

Recommended Operating Conditions (3)

Supply voltage (V _{VIN}).....	4.5V to 6V
Battery voltage (V _{BATT})	2.5V to 4.35V
Operating junction temp. (T _J) ..	-40°C to +125°C

Thermal Resistance (4)	θ_{JA}	θ_{JC}
QFN-24 (4mmx4mm)	42.....	9 °C/W

NOTES:

- 1) Exceeding these ratings may damage the device.
- 2) The maximum allowable power dissipation is a function of the maximum junction temperature T_J (MAX), the junction-to-ambient thermal resistance θ_{JA}, and the ambient temperature T_A. The maximum allowable continuous power dissipation at any ambient temperature is calculated by P_D (MAX) = (T_J (MAX)-T_A)/θ_{JA}. Exceeding the maximum allowable power dissipation produces an excessive die temperature, causing the regulator to go into thermal shutdown. Internal thermal shutdown circuitry protects the device from permanent damage.
- 3) The device is not guaranteed to function outside of its operating conditions.
- 4) Measured on JESD51-7, 4-layer PCB.

ELECTRICAL CHARACTERISTICS

$V_{IN} = 5.0V$, $T_A = 25^{\circ}C$, unless otherwise noted.

Parameter	Symbol	Condition	Min	Typ	Max	Units
IN-to-SYS N-FET on resistance	$R_{IN\ to\ SYS}$	$V_{CC} = 5V$		65		m Ω
High-side P-FET on resistance	R_{H_DS}	$V_{CC} = 5V$		30		m Ω
Low-side N-FET on resistance	R_{L_DS}	$V_{CC} = 5V$		30		m Ω
High-side P-FET peak current limit	I_{PEAK_HS}	CC charge mode/boost mode		6.5		A
		TC charge mode		3.2		A
Low-side N-FET peak current limit	I_{PEAK_LS}			6.3		A
Switching frequency	f_{sw}		510	620	720	kHz
VCC UVLO	V_{CC_UVLO}		1.95	2.15	2.35	V
VCC UVLO hysteresis				100		mV
PWIN lower threshold	V_{PWIN_L}	Rising	0.72	0.77	0.82	V
Lower threshold hysteresis				50		mV
PWIN upper threshold	V_{PWIN_H}	Rising	1.05	1.10	1.15	V
Upper threshold hysteresis				50		mV
Charge Mode						
Input quiescent current	I_{IN}	EN = 5V, battery floating			2.5	mA
		EN = 0V			1.5	mA
Input current limit	I_{IN_LIMIT}	$R_{ILIM} = 100k\Omega$	400	450	500	mA
		$R_{ILIM} = 56k\Omega$	720	810	900	
		$R_{ILIM} = 16.5k\Omega$	2400	2700	3000	
Input over-current threshold	$I_{IN(OCP)}$			4.2		A
Input over-current blanking time ⁽⁵⁾	$T_{INOCBLK}$			120		μ s
Input over-current recover time ⁽⁵⁾	$T_{INRECVR}$			100		ms
Terminal battery voltage	V_{BATT_FULL}	Connect VB to GND	4.179	4.200	4.221	V
		Leave VB floating or connect to logic high	4.034	4.055	4.075	
Recharge threshold	V_{RECH}	Connect to VB to GND	3.98	4.04	4.10	V
		Leave VB floating or connect to logic high	3.84	3.90	3.96	
Recharge threshold hysteresis				150		mV
Battery over-voltage threshold		As a percentage of V_{BATT_FULL}		102.5%		V_{BATT_FULL}
Constant charge (CC) current	I_{CC}	$RS1 = 20m\Omega$, $R_{ISET} = 120k\Omega$	850	1000	1150	mA
		$RS1 = 20m\Omega$, $R_{ISET} = 60.4k\Omega$	1725	1987	2250	
		$RS1 = 20m\Omega$, $R_{ISET} = 47.5k\Omega$	2225	2525	2825	
Trickle charge current	I_{TC}		125	250		mA
Trickle charge voltage threshold	V_{BATT_TC}	Connect to VB to GND	2.9	3.0	3.1	V
		Leave VB floating or connect to high logic	2.8	2.9	3.0	

ELECTRICAL CHARACTERISTICS (continued)
 $V_{IN} = 5.0V$, $T_A = 25^{\circ}C$, unless otherwise noted.

Parameter	Symbol	Condition	Min	Typ	Max	Units
Trickle charge hysteresis				200		mV
Termination charge current	I_{BF}	$RS1 = 20m\Omega$, $R_{ISET} = 60.4k\Omega$	2.5%	10%	17.5%	I_{CC}
		$RS1 = 20m\Omega$, $R_{ISET} = 47.5k\Omega$	2.5%	10%	17.5%	I_{CC}
Input-voltage-regulation reference	V_{REG}		1.13	1.15	1.17	V
Boost Mode						
SYS voltage range			4.2		6	V
Feedback voltage			1.13	1.15	1.17	V
Feedback input current		$V_{FB} = 1V$			200	nA
Boost SYS over-voltage protection threshold	$V_{SYS(OVP)}$	Threshold over V_{SYS} to turn off the converter during boost mode	5.40	5.55	5.70	V
SYS over-voltage protection threshold hysteresis		V_{SYS} falling from $V_{SYS(OVP)}$		125		mV
Boost quiescent current		$I_{SYS} = 0A$, $MODE = 5V$			1.4	mA
Programmable boost output current limit accuracy	I_{OLIM}	$RS1 = 20m\Omega$, $R_{OLIM} = 57.6k\Omega$	1.875	2.083	2.290	A
		$RS1 = 20m\Omega$, $R_{OLIM} = 51k\Omega$	2.1			
SYS over-current blanking time ⁽⁵⁾	$T_{SYSOCBLK}$			120		μs
SYS over-current recover time ⁽⁵⁾	$T_{SYSRECVR}$			1		ms
Weak battery threshold	$V_{BATT(LOW)}$	During boosting		2.40		V
		Before boost starts		2.75	2.90	V
Sleep Mode						
Battery leakage current	$I_{LEAKAGE}$	$V_{BATT} = 4.2V$, SYS floating, $V_{IN} = 0V$, $MODE = 0V$		15	30	μA
Indication and Logic						
ACOK, CHG, BOOST pin output low voltage		Sinking 1.5mA			400	mV
ACOK, CHG, BOOST pin leakage current		Connected to 5V			1	μA
NTC and time-out fault blinking frequency ⁽⁵⁾		$C_{TMR} = 0.1\mu F$, $I_{CHG} = 1A$		12.5		Hz
EN input logic low voltage					0.4	V
EN input high voltage			1.4			V
Mode input logic low voltage					0.4	V
Mode input logic high voltage			1.4			V

ELECTRICAL CHARACTERISTICS *(continued)*

V_{IN} = 5.0V, T_A = 25°C, unless otherwise noted.

Parameter	Symbol	Condition	Min	Typ	Max	Units
Protection						
Total charge time		C _{TMR} = 0.1μF, I _{CHG} = 1A		336		min
NTC low temp, rising threshold		R _{NTC} = NCP18XH103 (0°C)	65.6%	66.6%	67.6%	V _{sys}
NTC low temp, rising threshold hysteresis				1.0%		
NTC high temp, rising threshold		R _{NTC} = NCP18XH103 (50°C)	34%	35%	36%	
NTC high temp, rising threshold hysteresis				1.0%		
Charging current foldback threshold ⁽⁵⁾		Charge mode		120		°C
Thermal shutdown threshold ⁽⁵⁾				150		°C

NOTES:

5) Guaranteed by design.

TYPICAL CHARACTERISTICS

$C_{IN} = C_{BATT} = C_{SYS} = C_2 = 22\mu F$, $L_1 = 2.2\mu H$, $RS1 = 20m\Omega$, $C_4 = C_{TMR} = 0.1\mu F$, battery simulator, unless otherwise noted.

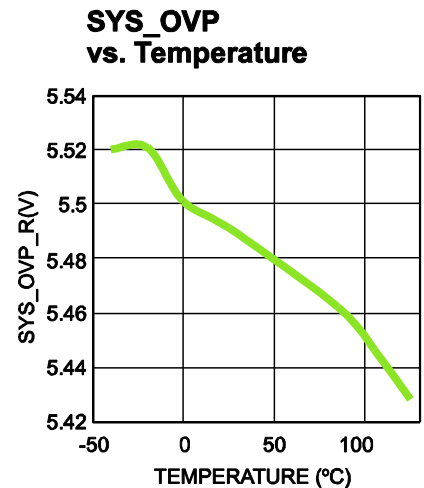
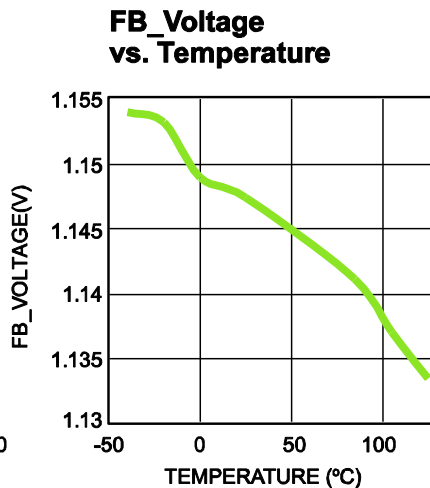
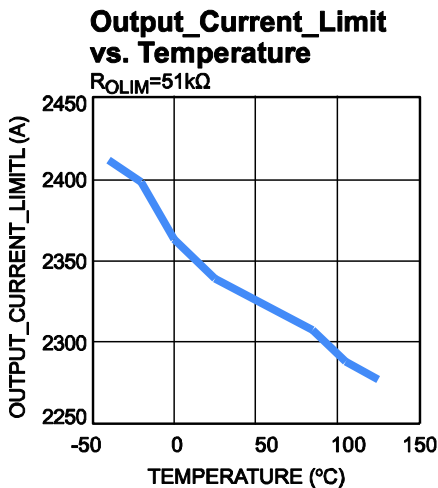
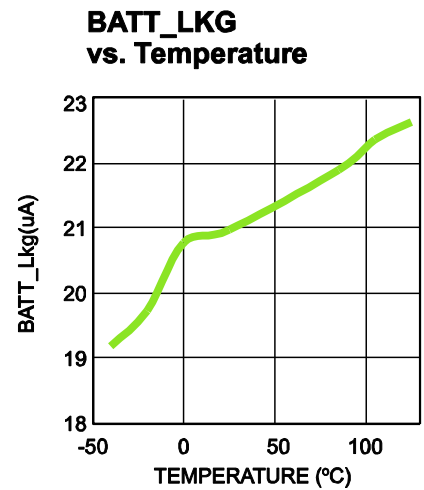
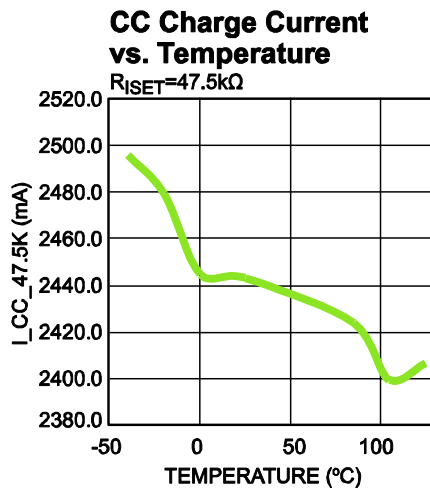
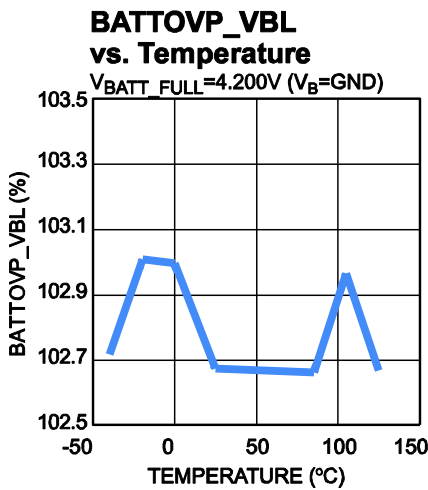
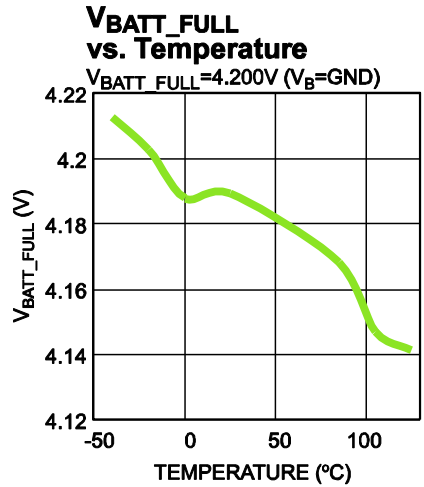
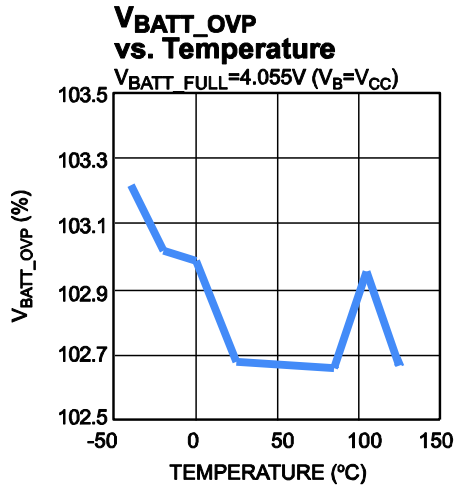
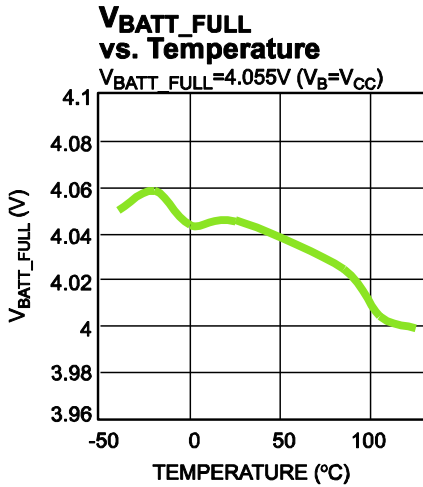

TYPICAL PERFORMANCE CHARACTERISTICS

For Charge Mode: $V_{IN} = 5V$, $I_{CHG} = 2.5A$, $L_{IN_LIM} = 2.7A$, $I_{SYS} = 0A$

For Boost Mode: $V_{BATT} = 3.7V$, $V_{SYS_SET} = 5V$, $I_{OLIM} = 2.1A$

$C_{IN} = C_{BATT} = C_{SYS} = C_2 = 22\mu F$, $L_1 = 2.2\mu H$, $RS1 = 20m\Omega$, $C_4 = C_{TMR} = 0.1\mu F$, battery simulator, unless otherwise noted.

Battery Charge Curve

$V_{BATT_FULL} = 4.2V$

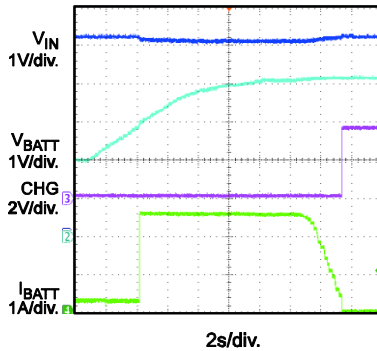

Auto Recharge

$V_{BATT_FULL} = 4.2V$

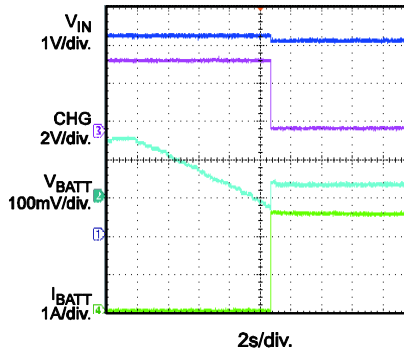

Battery Float Steady State

$V_{BATT_FULL} = 4.2V$

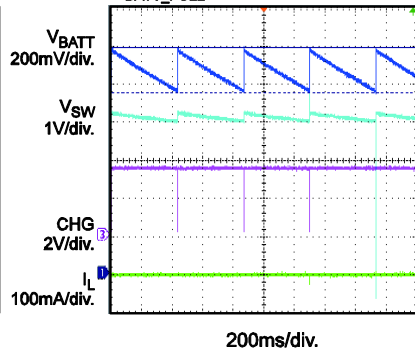

TC Charge Steady State

$V_{BATT_FULL} = 4.2V$, $V_{BATT} = 2V$,
 $f_{SW} = 600KHz$

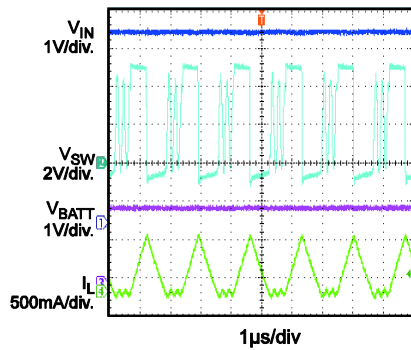

CC Charge Steady State

$V_{BATT_FULL} = 4.2V$, $V_{BATT} = 3.7V$,
 $f_{SW} = 600KHz$

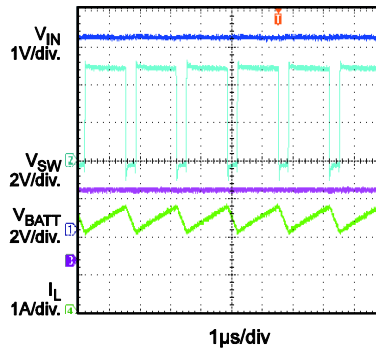

CV Charge Steady State

$V_{BATT_FULL} = 4.2V$, $V_{BATT} = 4.2V$,
 $f_{SW} = 600KHz$

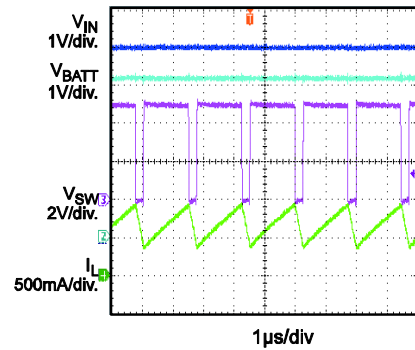

Constant Current Charge Efficiency

$V_{BATT_FULL} = 4.2V$, $V_{BATT} = 0.5-4.2V$,
 $f_{SW} = 600kHz$

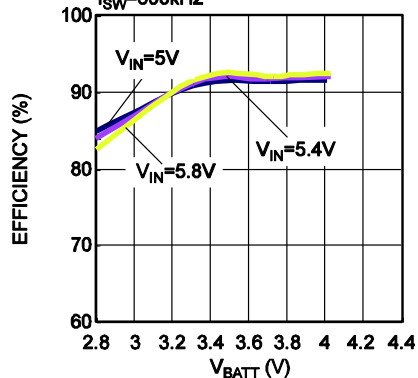

Constant Voltage Charge Efficiency

$V_{BATT_FULL} = 4.2V$, $V_{BATT} = 4.2V$,
 $f_{SW} = 600kHz$

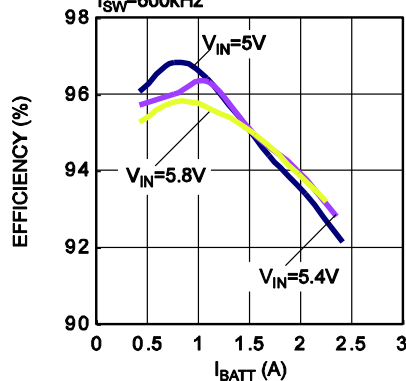

TYPICAL PERFORMANCE CHARACTERISTICS (continued)

For Charge Mode: $V_{IN} = 5V$, $I_{CHG} = 2.5A$, $L_{IN_LIM} = 2.7A$, $I_{SYS} = 0A$

For Boost Mode: $V_{BATT} = 3.7V$, $V_{SYS_SET} = 5V$, $I_{OLIM} = 2.1A$

$C_{IN} = C_{BATT} = C_{SYS} = C_2 = 22\mu F$, $L_1 = 2.2\mu H$, $RS1 = 20m\Omega$, $C_4 = C_{TMR} = 0.1\mu F$, battery simulator, unless otherwise noted.

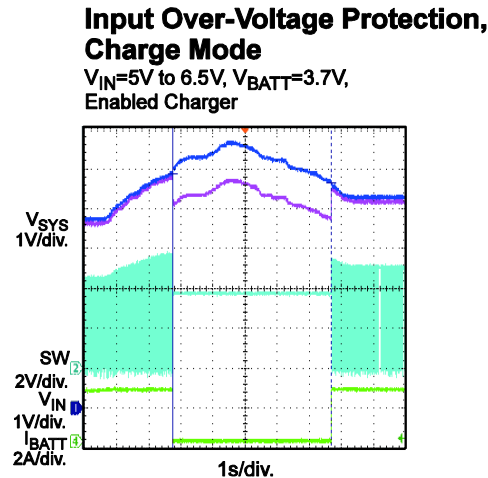
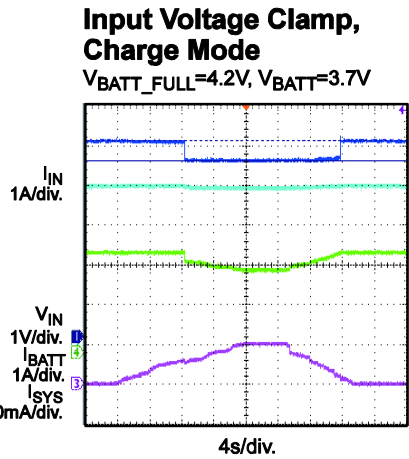
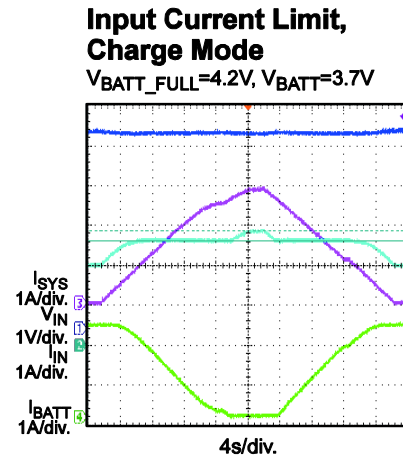
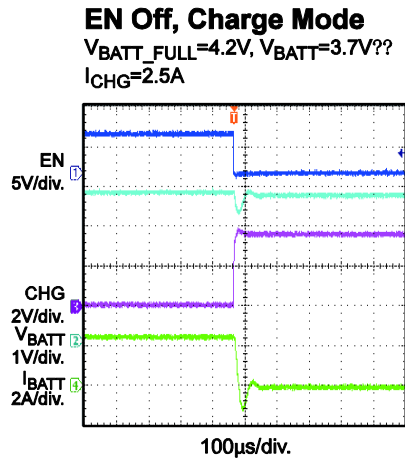
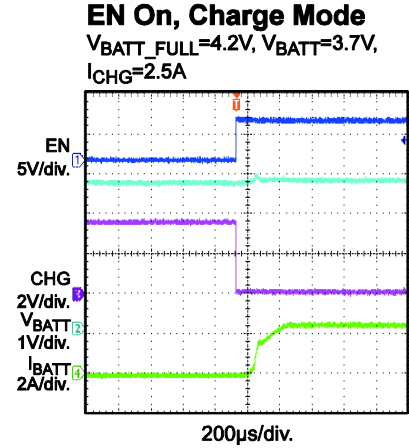
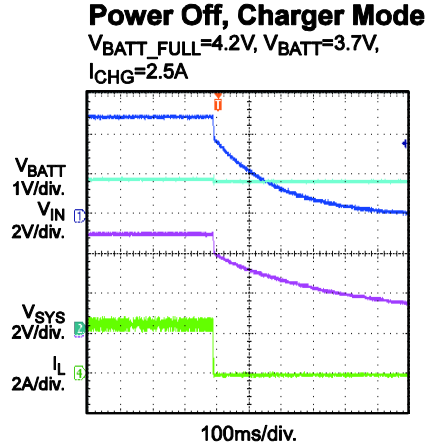
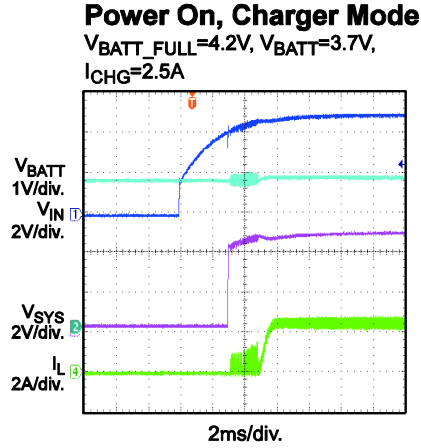

TYPICAL PERFORMANCE CHARACTERISTICS (continued)

For Charge Mode: $V_{IN} = 5V$, $I_{CHG} = 2.5A$, $L_{IN_LIM} = 2.7A$, $I_{SYS} = 0A$

For Boost Mode: $V_{BATT} = 3.7V$, $V_{SYS_SET} = 5V$, $I_{OLIM} = 2.1A$

$C_{IN} = C_{BATT} = C_{SYS} = C_2 = 22\mu F$, $L_1 = 2.2\mu H$, $R_{S1} = 20m\Omega$, $C_4 = C_{TMR} = 0.1\mu F$, battery simulator, unless otherwise noted.

Power On, Boost Mode

$V_{SYS_SET}=5V$, $V_{BATT}=3.7V$,
No SYS Load

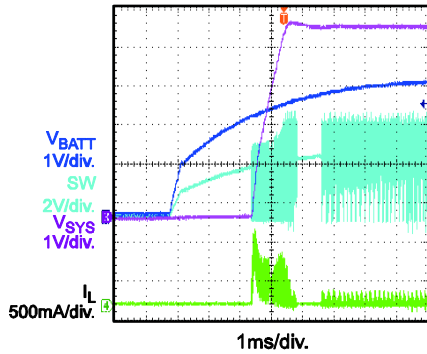

Power Off, Boost Mode

$V_{SYS_SET}=5V$, $V_{BATT}=3.7V$,
No SYS Load

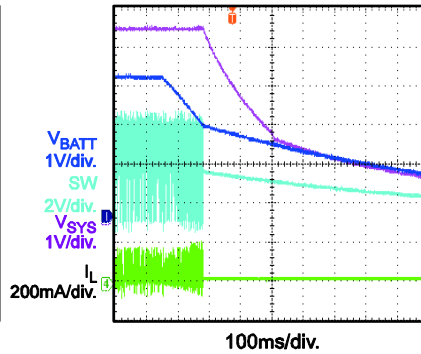

Power On, Boost Mode

$V_{SYS_SET}=5V$, $V_{BATT}=3V$,
 $R_{SYS_LOAD}=2.5\Omega$

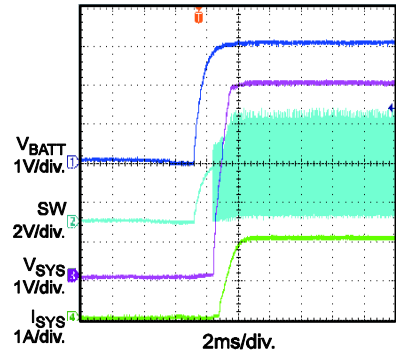

Power Off, Boost Mode

$V_{SYS_SET}=5V$, $V_{BATT}=3V$,
 $R_{SYS_LOAD}=2.5\Omega$

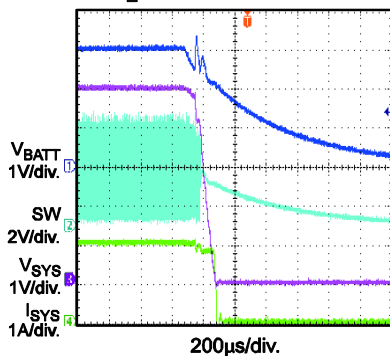

Mode On, Boost Mode

$V_{SYS_SET}=5V$, $V_{BATT}=3.7V$,
No SYS Load

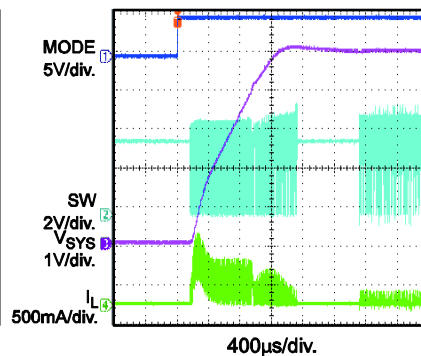

Mode Off, Boost Mode

$V_{SYS_SET}=5V$, $V_{BATT}=3.7V$,
No SYS Load

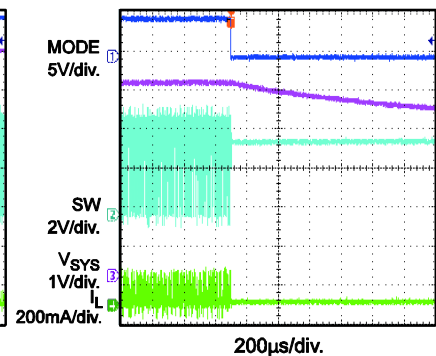

Mode On, Boost Mode

$V_{SYS_SET}=5V$, $V_{BATT}=3.7V$,
 $R_{SYS_LOAD}=2\Omega$

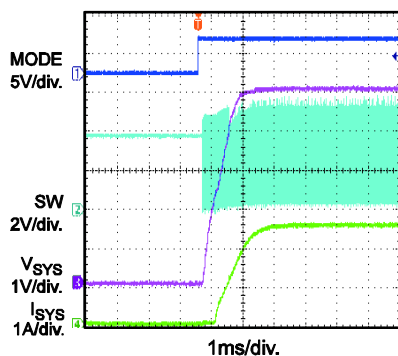

Mode Off, Boost Mode

$V_{SYS_SET}=5V$, $V_{BATT}=3.7V$,
 $R_{SYS_LOAD}=2\Omega$

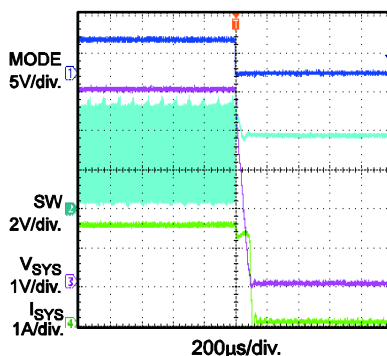

SYS Output Current Limit

$V_{SYS_SET}=5V$, $V_{BATT}=3.7V$,
 $I_{OLIM_SET}=2.5A$

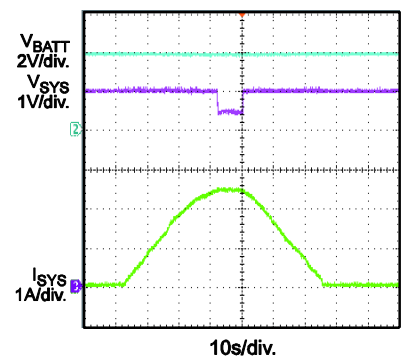

TYPICAL PERFORMANCE CHARACTERISTICS *(continued)*

For Charge Mode: $V_{IN} = 5V$, $I_{CHG} = 2.5A$, $L_{IN_LIM} = 2.7A$, $I_{SYS} = 0A$

For Boost Mode: $V_{BATT} = 3.7V$, $V_{SYS_SET} = 5V$, $I_{OLIM} = 2.1A$

$C_{IN} = C_{BATT} = C_{SYS} = C_2 = 22\mu F$, $L_1 = 2.2\mu H$, $RS1 = 20m\Omega$, $C_4 = C_{TMR} = 0.1\mu F$, battery simulator, unless otherwise noted.

SYS Short-Circuit Entry
 $V_{SYS_SET}=5V$, $V_{BATT}=3.7V$

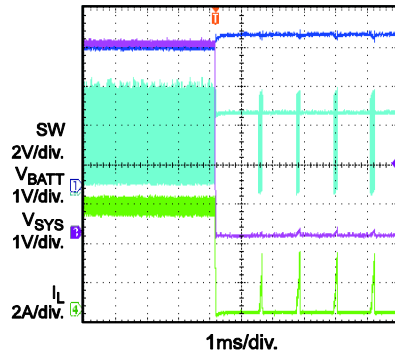

SYS Short-Circuit Recovery
 $V_{SYS_SET}=5V$, $V_{BATT}=3.7V$,

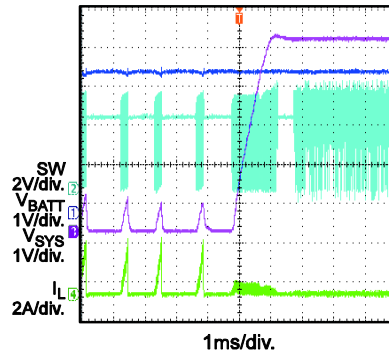

SYS Over-Voltage Protection
 $V_{SYS_SET}=6.5V$, $V_{BATT}=3.7V$

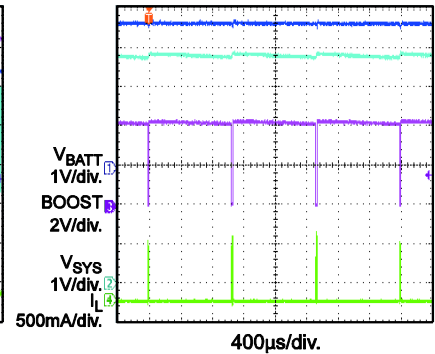

SYS Load Transient
 $V_{SYS_SET}=5V$, $V_{BATT}=3V$,
 $I_{SYS}=80mA$ to $1A$

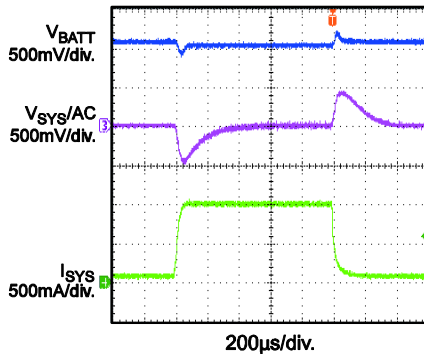

SYS Load Transient
 $V_{SYS_SET}=5V$, $V_{BATT}=3.7V$,
 $I_{SYS}=1A$ to $2.2A$

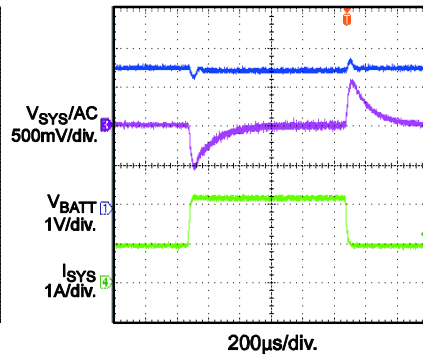

SYS Load Transient
 $V_{SYS_SET}=5V$, $V_{BATT}=3.7V$,
 $I_{SYS}=0.3A$ to $2.2A$

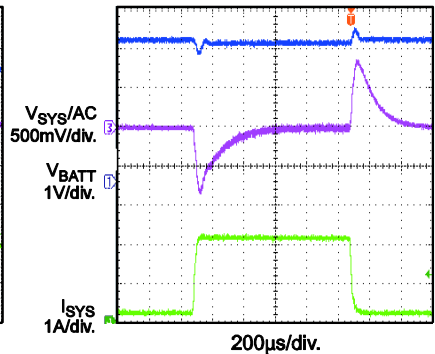

Efficiency
 $V_{SYS_SET}=5V$, $V_{SYS}=5V$, $F_S=600kHz$

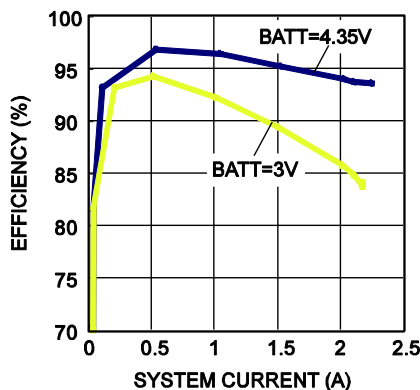

Boost Output V-I Curve
 $V_{BATT}=3.7V$, $V_{SYS}=5V$

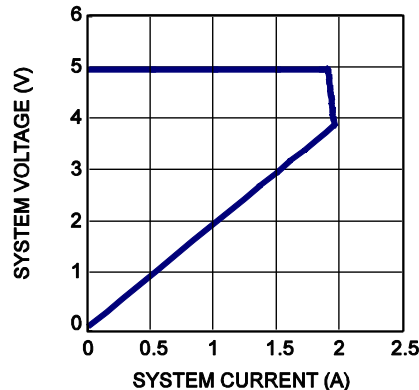

Programmable Output Current Limit vs. Battery
 $R_{OLIM}=59k\Omega$, $V_{SYS}=5V$

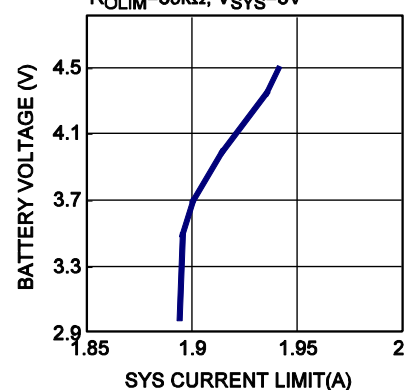

PIN FUCTIONS

Pin #	Name	Description
1, 23, 24	PGND	Power ground.
2	CHG	Charge completion indicator. CHG at logic low indicates charge mode. CHG is an open-drain pin when the charge is complete or suspended.
3	BOOST	Boost mode indicator. BOOST at logic low indicates boost mode. BOOST is an open-drain pin during charge mode or sleep mode operation.
4	CSP	Battery charge current sense positive input.
5	BATT	Positive battery terminal/battery charge current sense negative input.
6	AGND	Analog ground.
7	OLIM	Programmable output current limit for boost mode. Connect an external resistor to GND to program the system current in boost mode. R_{OLIM} cannot be lower than 47.5k Ω .
8	ISET	Programmable charge current. Connect an external resistor from ISET to GND to program the charge current.
9	NTC	Negative temperature coefficient (NTC) thermistor.
10	FB	System voltage feedback input.
11	ACOK	Valid input supply indicator. ACOK at logic low indicates the presence of a valid power supply.
12	REG	Input voltage feedback for the input voltage regulation loop. Connect REG to the tap of an external resistor divider from VIN to GND to program the input voltage regulation. Once the voltage at REG drops to the inner threshold, the charge current is reduced to maintain the input voltage at the regulation value.
13	TMR	Oscillator period timer. Connect a timing capacitor between TMR and GND to set the oscillator period. Short TMR to GND to disable the timer function.
14	PWIN	Input pin to detect the presence of valid input power. Pull PWIN to GND to turn off the IN-to-SYS pass-through FET
15	ILIM	Input current set. Connect ILIM to GND with an external resistor to program the input current limit in charge mode.
16	VCC	Internal circuit power supply. Bypass VCC to GND with a ceramic capacitor no higher than 100nF. VCC cannot carry an external load higher than 5mA.
17	VB	Programmable battery-full voltage. Leave VB floating or connect VB to logic high for 4.2V. Connect VB to GND for 4.35V.
18	EN	Charge control input. EN at logic high enables charging. EN at logic low disables charging. EN is active only when ACOK is low (input power is OK).
19	MODE	Mode selection. Set MODE to logic high to operate the device in boost mode. Set MODE to logic low to operate the device in sleep mode. MODE is active only when ACOK is high (input power is not available).
20	VIN	Adapter input. Place a bypass capacitor close to VIN to prevent large input voltage spikes.
21	SYS	System output. A minimum 22 μ F ceramic capacitor is required to be placed as close to SYS and PGND as possible. The total capacitance should not be lower than 44 μ F.
22	SW	Switch output node. Do not to place vias on the SW plane during PCB layout.

BLOCK DIAGRAM

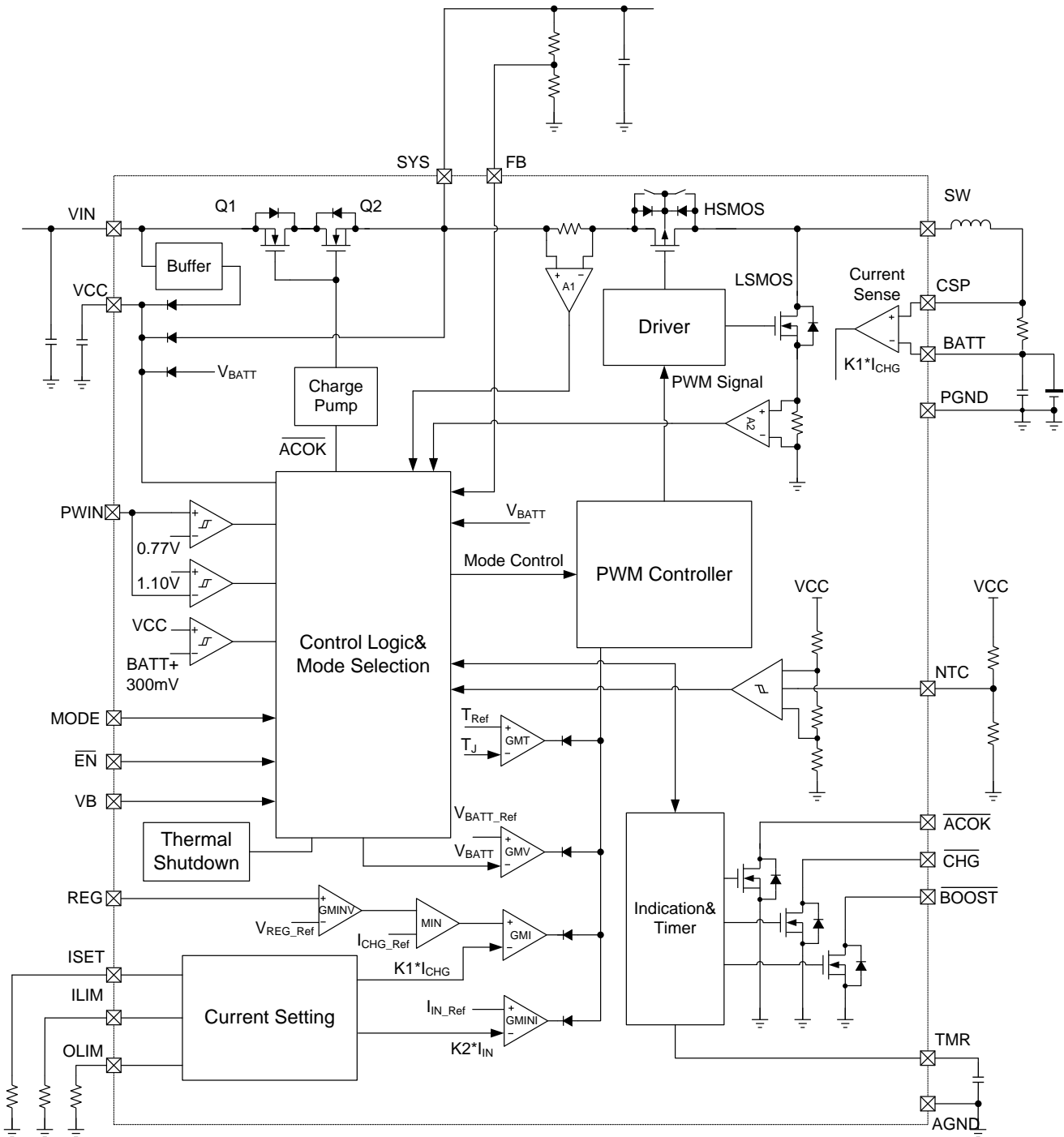

Figure 1: Functional Block Diagram in Charge Mode

BLOCK DIAGRAM (continued)

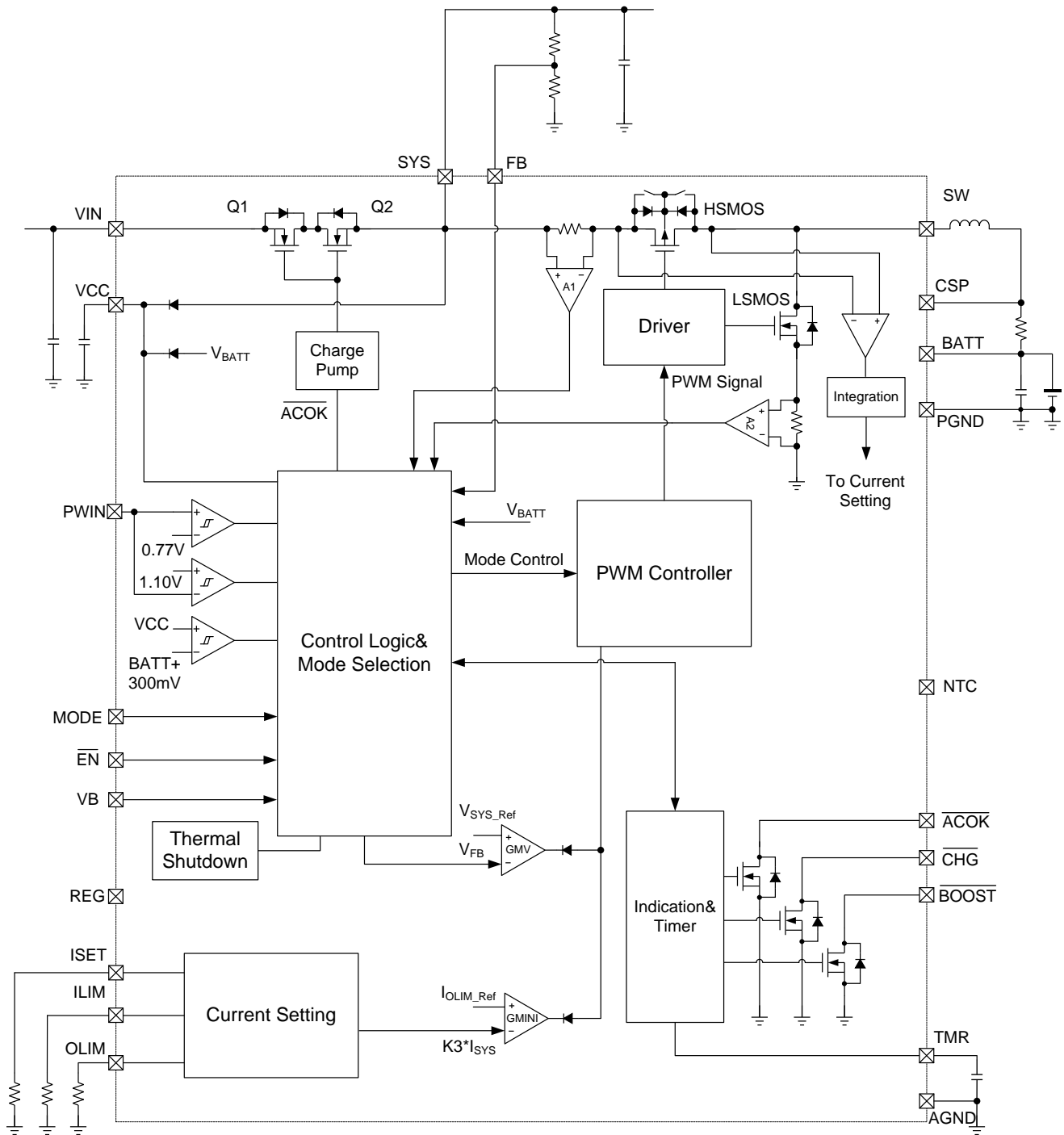

Figure 2: Functional Block Diagram in Boost Mode

OPERATION FLOW CHART

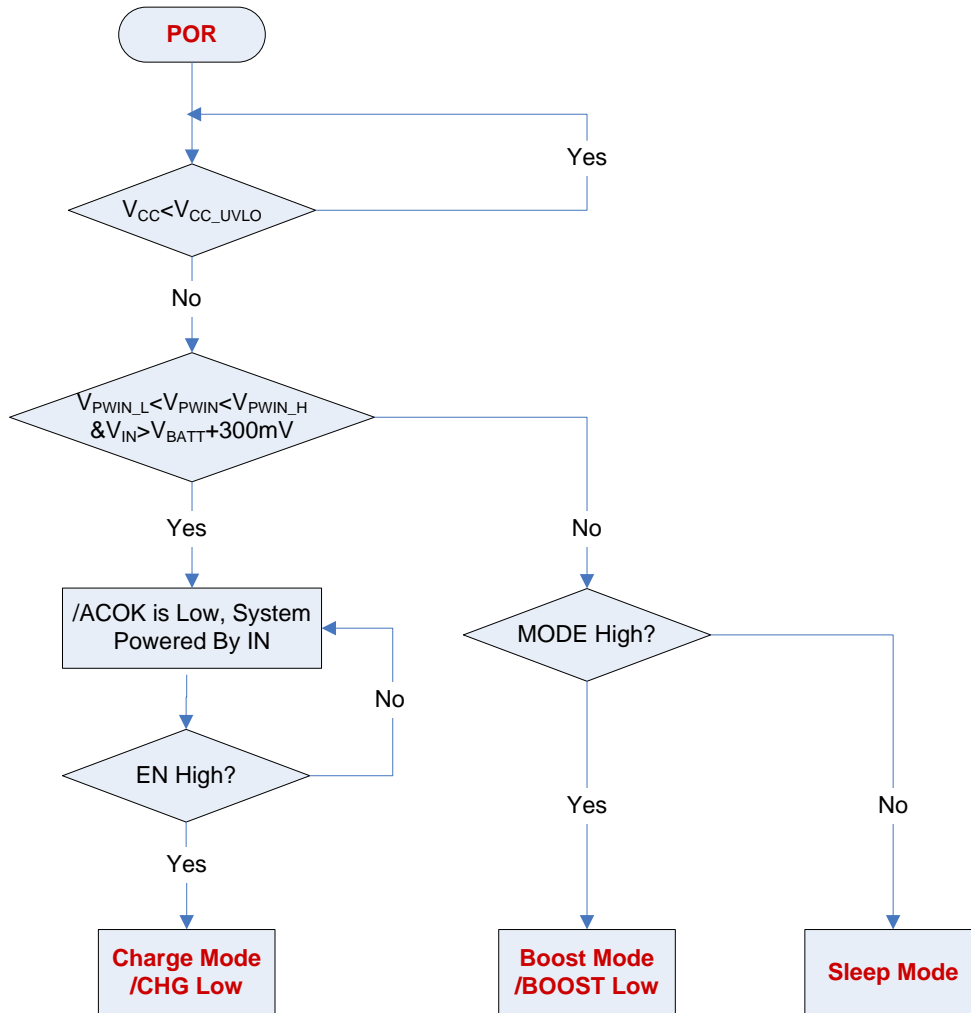

Figure 3: Mode Selection Flow Chart

OPERATION FLOW CHART (continued)

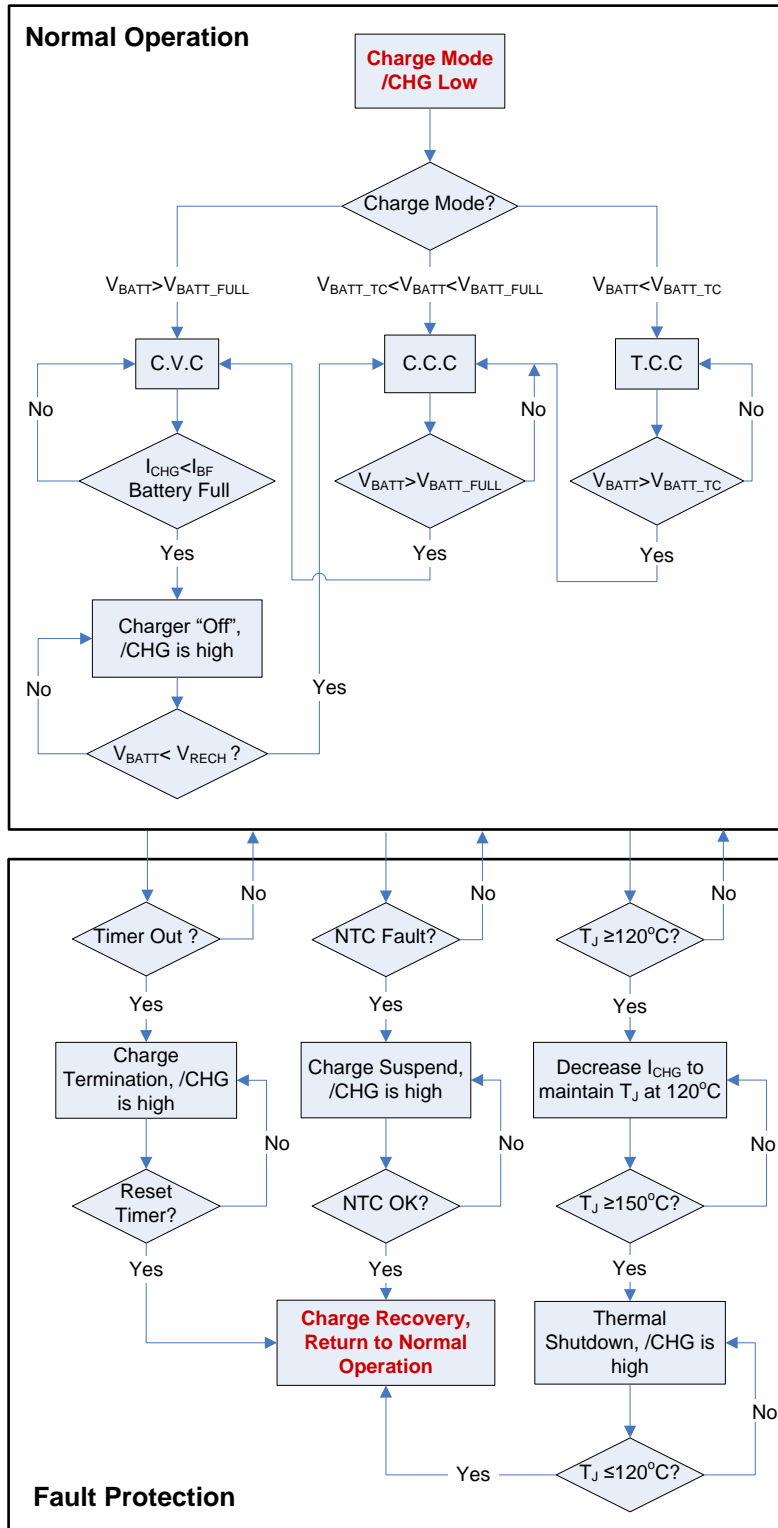

Figure 4: Normal Operation and Fault Protection in Charge Mode

OPERATION FLOW CHART (continued)

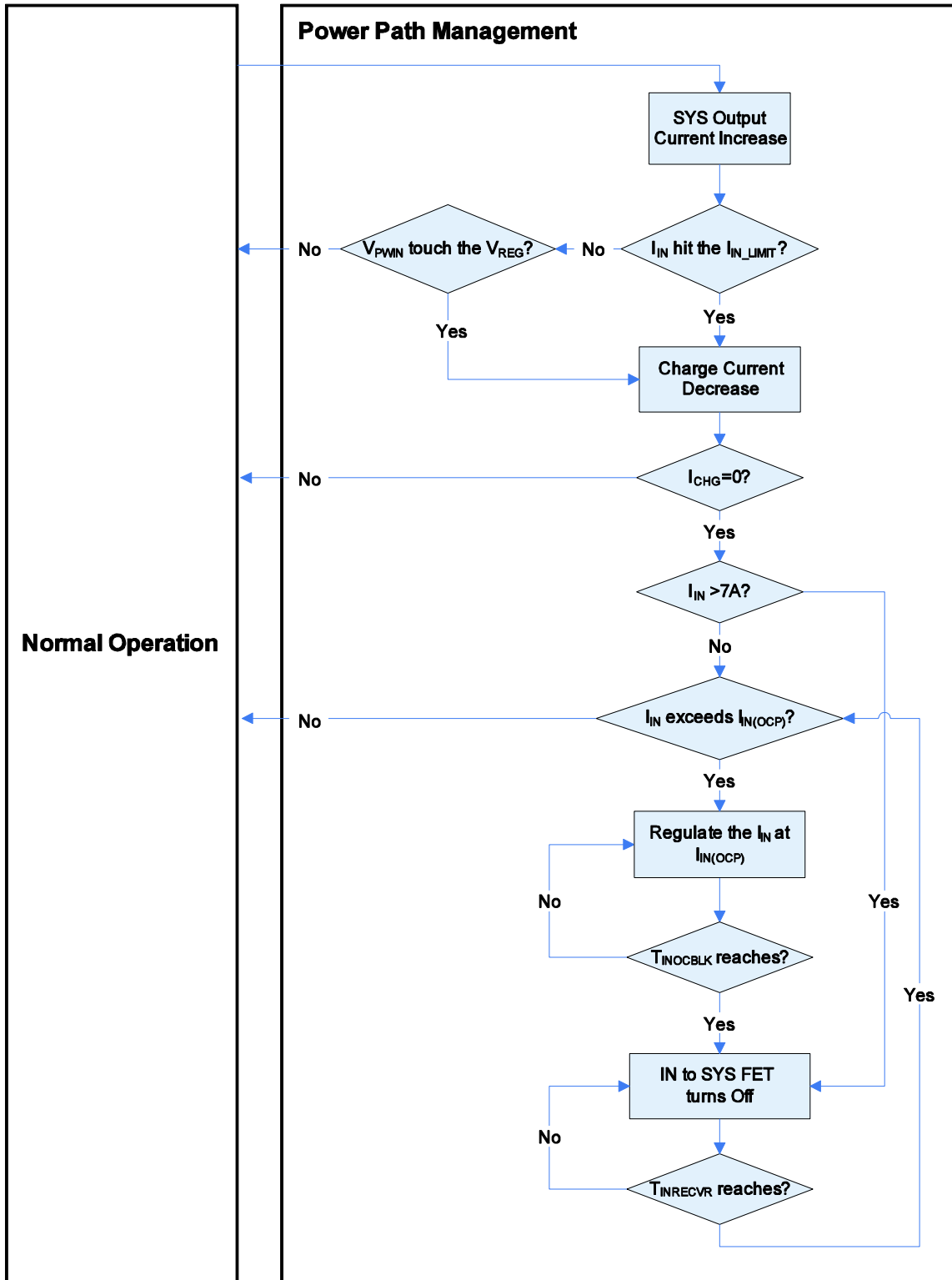

Figure 5: Power-Path Management in Charge Mode

OPERATION FLOW CHART (continued)

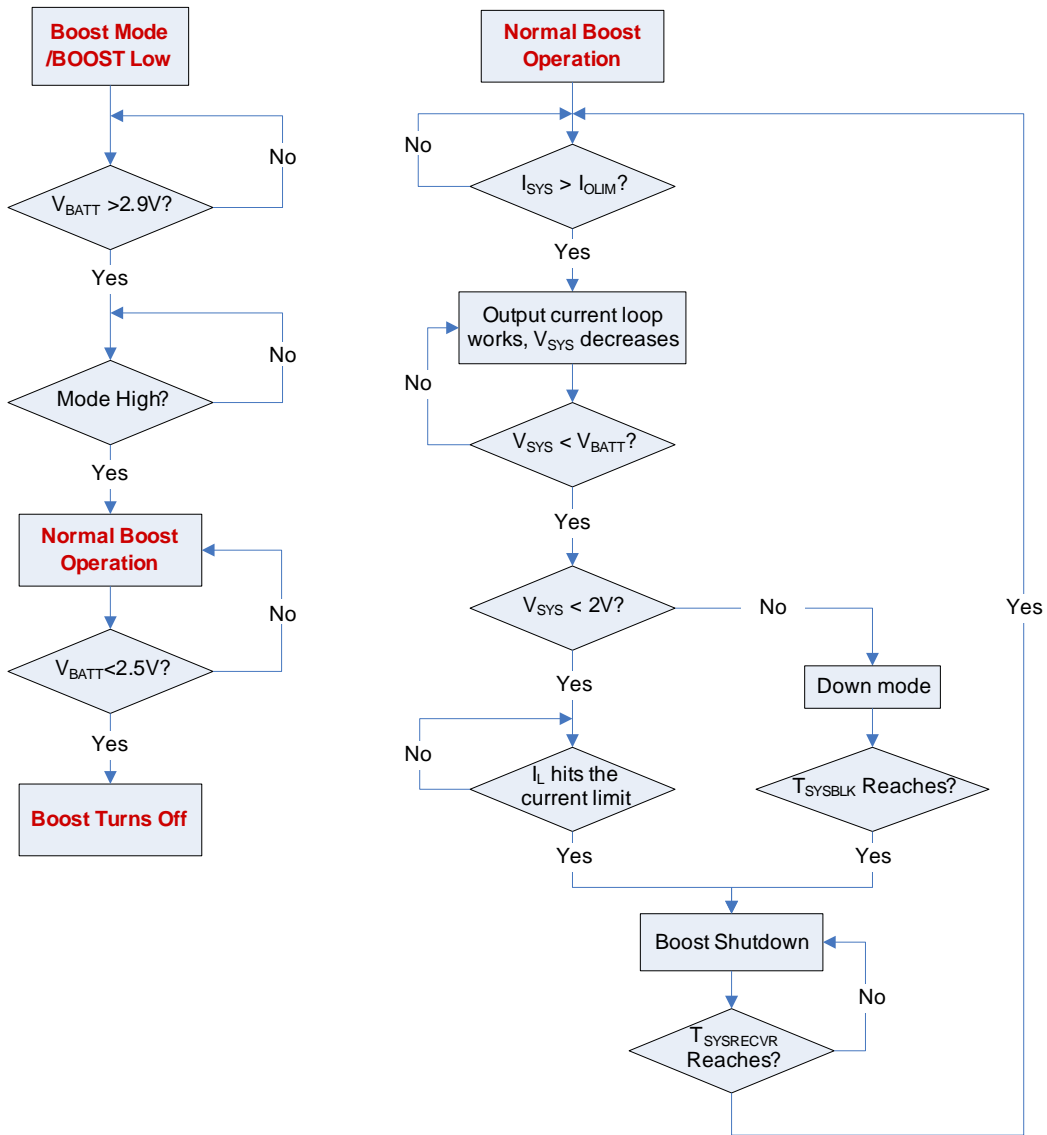

Figure 6: Operation Flow Chart in Boost Mode

START-UP TIME FLOW IN CHARGE MODE

Condition: EN = 5V, MODE = 0V, ACOK and CHG are always pulled up to an external 5V.

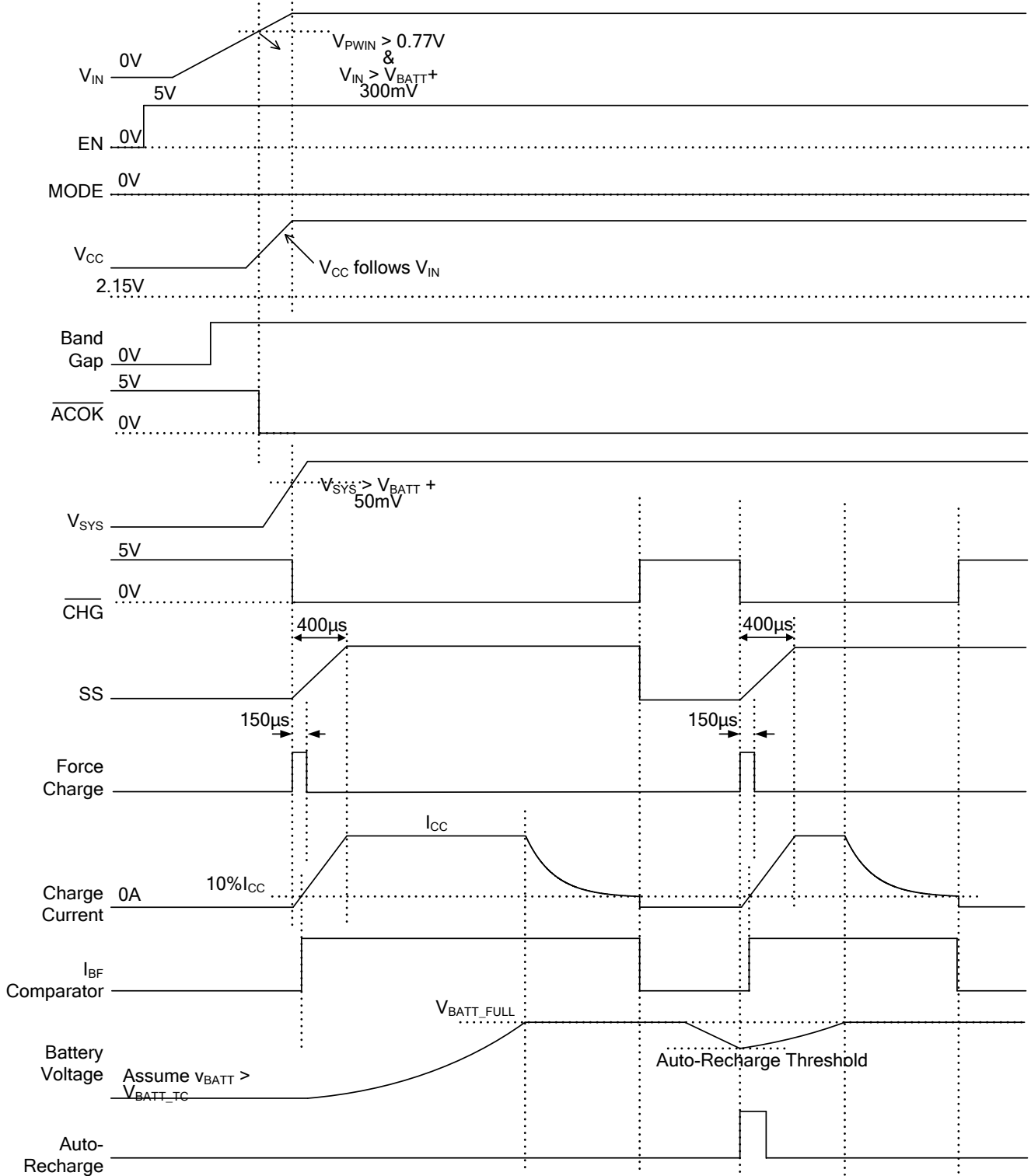

Figure 7: Input Power Start-Up Time Flow in Charge Mode

START-UP TIME FLOW IN CHARGE MODE (continued)

Condition: EN = 5V, MODE = 0V, ACOK and CHG are always pulled up to an external 5V.

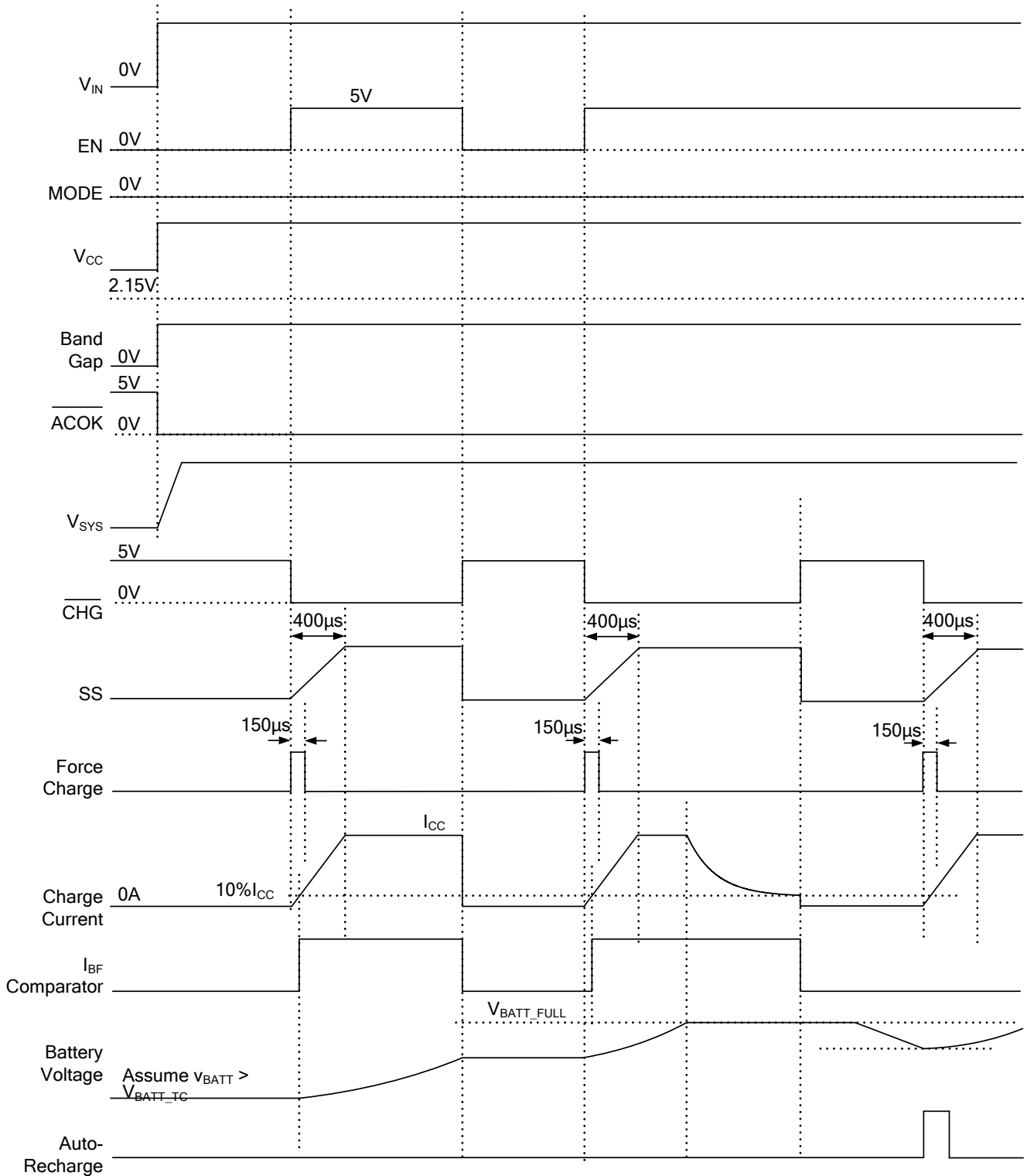

Figure 8: EN Start-Up Time Flow in Charge Mode

START-UP TIME FLOW IN BOOST MODE (continued)

Condition: $V_{IN} = 0V$, Mode = 5V, BOOST is always pulled up to an external constant 5V.

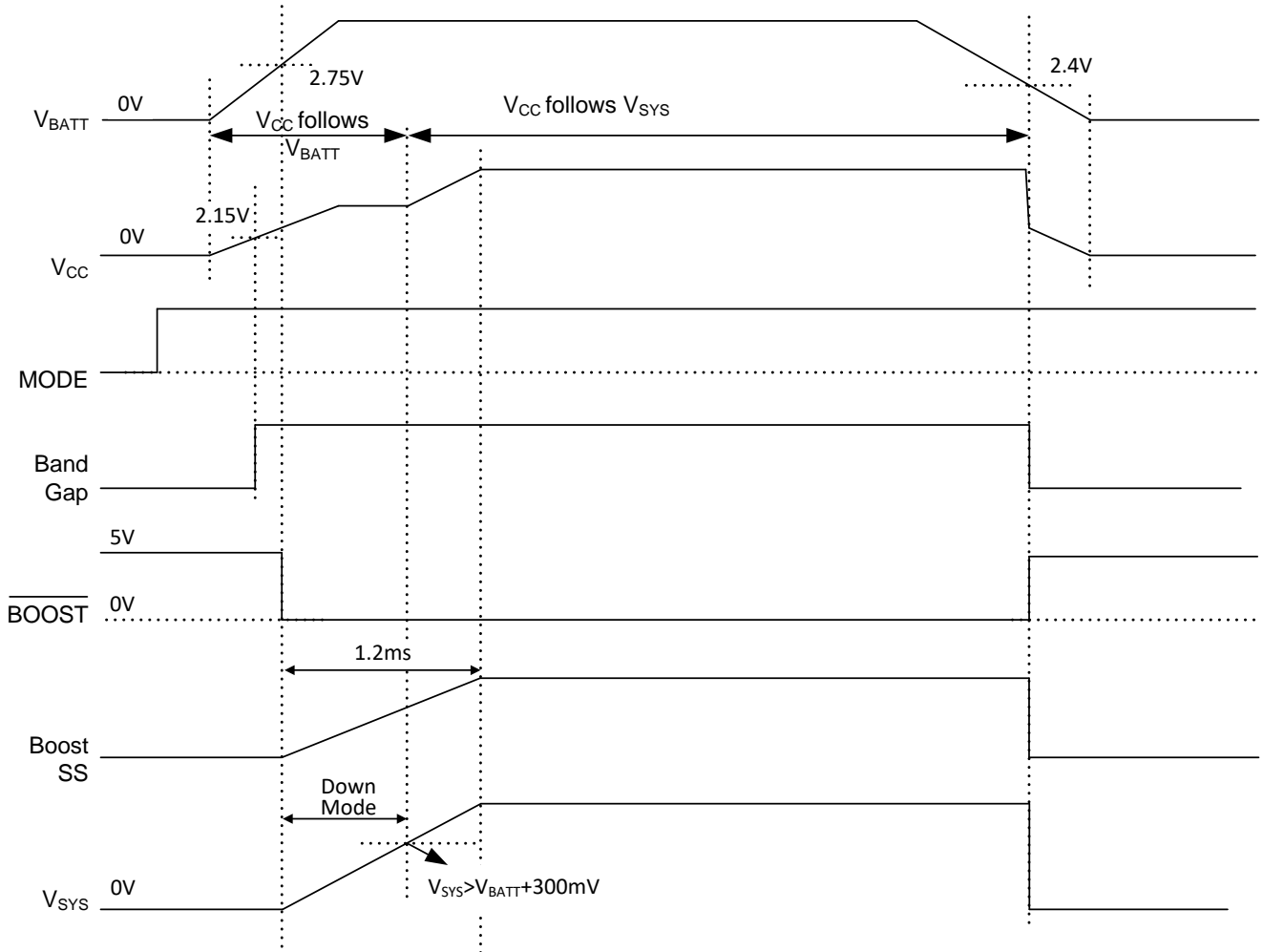

Figure 9: Battery Power Start-Up Time Flow in Boost Mode

START-UP TIME FLOW IN BOOST MODE (continued)

Condition: $V_{IN} = 0V$, BOOST is always pulled up to an external constant 5V.

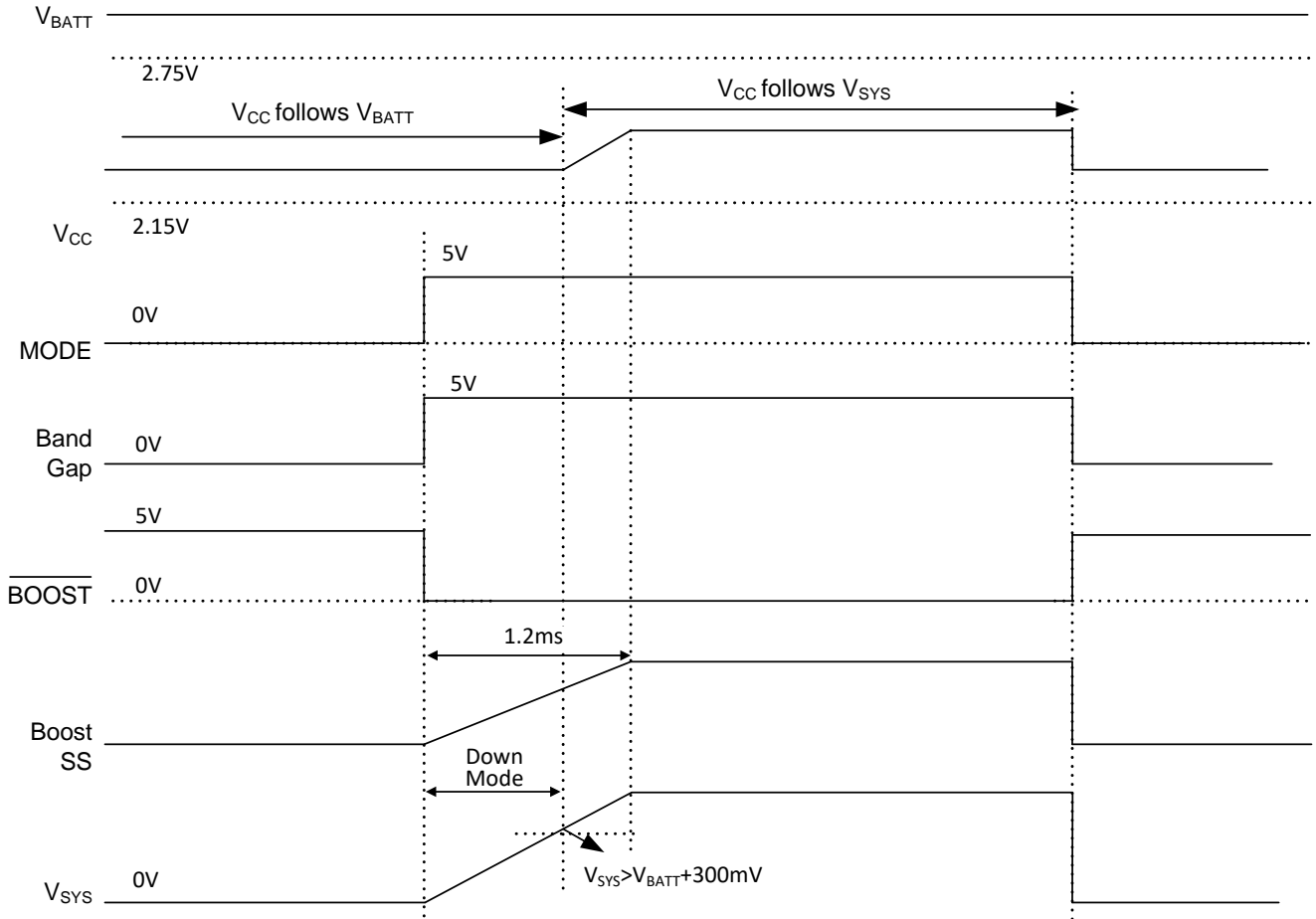

Figure 10: Mode Start-Up Time Flow in Boost Mode

OPERATION

The MP2637A is a highly-integrated, flexible, switch-mode battery charger with system power path management designed for single-cell Li-ion or Li-polymer batteries for use in a wide range of applications. Depending on the status of the input, the MP2637A can operate in three different modes: charge mode, boost mode, or sleep mode.

In charge mode, the MP2637A can work with a single cell Li-ion or Li-polymer battery. In boost mode, the MP2637A boosts the battery voltage to V_{SYS_SET} to power higher voltage system rails. In sleep mode, both charging and boost operations are disabled and the device enters power-saving mode to help reduce the overall power consumption. The MP2637A monitors V_{IN} to allow for a smooth transition between different modes of operation.

CHARGE MODE OPERATION

Charge Cycle (Trickle Charge → CC Charge → CV Charge)

In charge mode, the MP2637A has five control loops to regulate the input current, input voltage, charge current, charge voltage, and device junction temperature. The MP2637A charges the battery in three phases: trickle current (TC), constant current (CC), and constant voltage (CV). While charge operation is enabled, all five loops are active, but only one determines the IC behavior. A typical battery charge profile is shown in Figure 11a. The charger remains in TC charge mode until the battery voltage reaches the TC-to-CC threshold. Otherwise, the charger enters CC charge mode. When the battery voltage rises to the CV mode threshold, the charger operates in CV mode. Figure 11b shows a typical charge profile when the input current limit loop dominates during CC charge mode. In this case, the charger maximizes the charging current due to the switching mode charging solution, resulting in faster charging than a traditional linear solution.

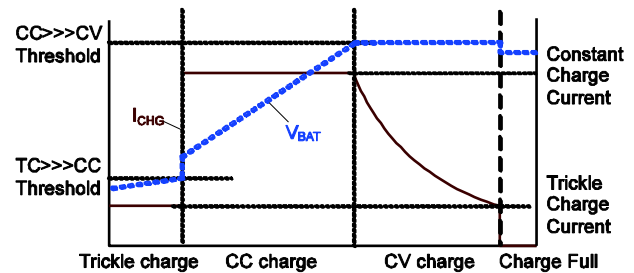

a) Without input current limit

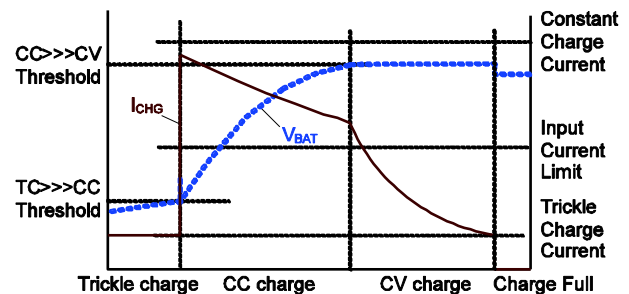

b) With input current limit

Figure 11: Typical Battery Charge Profile

Auto-Recharge

Once the battery charge cycle is completed, the charger remains off. During this time, the system load may consume battery power, or the battery may self-discharge. To ensure that the battery will not deplete, a new charge cycle begins automatically when the battery voltage falls below the auto-recharge threshold and the input power is present. The timer is reset when the auto-recharge cycle begins.

During the off state after the battery is fully charged, if the input power restarts or the EN signal refreshes, the charge cycle starts, and the timer resets, regardless of the battery voltage.

Battery Over-Voltage Protection (OVP)

The MP2637A has battery over-voltage protection (OVP). If the battery voltage exceeds the battery over-voltage threshold, (102.5% of the battery-full voltage), charging is disabled. Under this condition, an internal 5kΩ dummy load draws a current from BATT to decrease the battery voltage and protect the battery.

Timer Operation in Charge Mode

The MP2637A uses an internal timer to terminate the charging. The timer remains active during the charging process. An external capacitor between TMR and GND programs the charge cycle duration. The total charge time can be calculated with Equation (1):

$$\tau_{TOTAL_TMR} = \frac{3.4 \times 10^6 \times 1.6(V) \times C_{TMR}(\mu F)}{1.25 \times I_{CHG}(A) \times RS1(m\Omega) + 2(\mu A)} \text{ (s)} \quad (1)$$

Negative Temperature Coefficient (NTC) Input for Battery Temperature Monitoring

The MP2637A has a built-in NTC resistance window comparator which allows the MP2637A to monitor the battery temperature via the battery-integrated thermistor. Connect an appropriate resistor from V_{SYS} to the NTC pin, and connect the thermistor from the NTC pin to GND. The resistor divider determines the NTC voltage depending on the battery temperature. If the NTC voltage falls outside of the NTC window, the MP2637A stops charging. The charger restarts if the temperature goes back into NTC window range. Please refer to Application Information section on page 30 for the appropriate resistance selection.

Input Current Limiting in Charge Mode (ILIM)

The MP2637A has a dedicated pin (ILIM) used to program the input current limit. The current at ILIM is a fraction of the input current. The voltage at ILIM indicates the average input current of the switching regulator as determined by the resistor value between ILIM and GND. As the input current approaches the programmed input current limit, the charge current is reduced to give priority to the system power. Determine the input current-limit threshold with Equation (2):

$$I_{ILIM} = \frac{45(k\Omega)}{R_{ILIM}(k\Omega)} \text{ (A)} \quad (2)$$

Input Voltage Regulation in Charge Mode

In charge mode, if the input power source is not sufficient enough to support both the charge current and system load current, the input voltage decreases. As the input voltage approaches the programmed input voltage regulation value, the charge current is reduced to give priority to the system power and

maintain proper regulation of the input voltage. The input voltage can be regulated by a resistor divider from V_{IN} to REG to AGND, according to Equation (3):

$$V_{REG} = V_{IN_R} \times \frac{R5}{R3 + R5} \text{ (V)} \quad (3)$$

Where V_{REG} is the internal voltage reference (1.15V), and V_{IN_R} is the desired regulation voltage.

Integrated Over-Current Protection (OCP) and Over-Voltage Protection (OVP) for Pass-Through Path

The MP2637A has an integrated IN-to-SYS pass-through path to allow for direct connection of the input voltage to the system, even if charging is disabled. The MP2637A monitors both the input current and voltage continuously. In the event of over-load, the charge current is reduced to ensure priority of the system power requirements.

Additionally, the MP2637A also features input over-current and over-voltage protection for the IN-to-SYS pass-through path.

Input Over-Current Protection (OCP)

If the total input current exceeds 4.2A, Q2 is controlled linearly to regulate the current (see Figure 12). If the current continues to exceeds 4.2A after 120 μ s of blanking time, Q2 is turned off. If the input current exceeds 7A, Q2 is turned off almost instantaneously and without any blanking time to protect both Q1 and Q2.

Input Over-Voltage Protection (OVP)

The MP2637A uses the PWIN pin to sense the status of the input voltage. When the voltage at PWIN is lower than 0.77V or higher than 1.10V, an invalid input power source is detected by the MP2637A. At this time, the IN-to-SYS pass-through path is turned off. An OVP threshold can be programmed via PWIN to prevent an over-voltage event from occurring on the SYS side when plugging in an incorrect adapter.

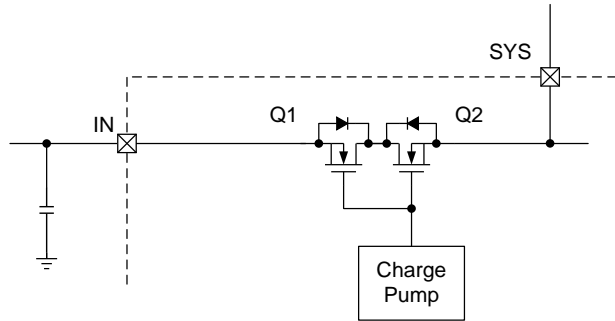

Figure 12: Integrated Pass-Through Path

Charge Current Setting

The external sense resistors (RS1 and R_{ISET}), program the battery charge current (I_{CHG}). Select R_{ISET} based on RS1 with Equation (4):

$$I_{CHG} (A) = \frac{2400}{R_{ISET} (k\Omega) \times RS1 (m\Omega)} \quad (4)$$

Battery Short Protection

The MP2637A has two current-limit thresholds. CC and CV modes have a peak-current limit threshold of 6.5A, while TC mode has a current-limit threshold of 3.2A. Therefore, the current-limit threshold decreases to 3.2A when the battery voltage drops below the TC threshold. Moreover, the switching frequency also decreases when the BATT voltage drops to 40% of the charge-full voltage.

Thermal Foldback Function

The MP2637A implements thermal protection to prevent thermal damage to the IC and the surrounding components. An internal thermal sense and feedback loop decrease the programmed charge current automatically when the die temperature reaches 120°C. This function is called charge current thermal foldback. This function protects against thermal damage and can also set the charge current based on requirements rather than worst-case conditions while ensuring safe operation. Furthermore, the MP2637A includes a thermal shutdown protection, where charging stops if the junction temperature rises to 150°C.

Non-Sync Operation Mode

During charging mode, the MP2637A monitors the total input current flowing from IN to SYS continuously. When the input current is lower than 170mA, the low-side switch operates as a non-synchronous FET.

Constant-Off-Time Control for Large Duty Charging Operation

The MP2637A has a built-in 600kHz frequency oscillator for the switching frequency. Unlike a traditional fixed frequency, the MP2637A features a constant-off-time control to support the constant-current charge, even when the input voltage is very close to the battery voltage. The MP2637A compares the high-side FET sense current with comp level continuously (see Figure 13). If the sense current does not reach the comp level within the original switching period, the next clock is delayed until the sense current reaches the comp level. As a result, the duty cycle is able to be extended as large as possible.

Full Operation Indication

The MP2637A integrates indicators for the following conditions shown in Table 2.

The blinking frequency can be calculated with Equation (5):

$$F_{Blinking} = \frac{1(\mu A)}{0.8 \times C_{TMR} (\mu F)} \quad (5)$$

Table 2: Indicator for Each Operation Mode

Operation		ACOK	CHG	BOOST
Charge mode	In Charging	Low	Low	High
	End of charge, charging disabled, battery OVP		High	
	NTC fault, timer out		Blinking	
Boost mode		High	High	Low
Sleep mode		High	High	High

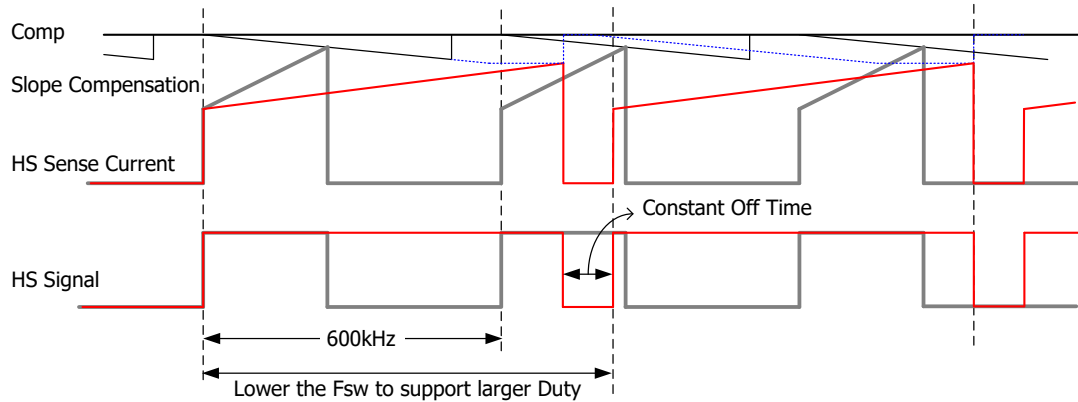

Figure 13: Constant-Off-Time Operation Profile

BOOST MODE OPERATION

Low-Voltage Start-Up

The minimum battery voltage required to start up the circuit in boost mode is 2.75V. Initially, when V_{SYS} is less than V_{BATT} , the MP2637A works in down mode. In this mode, the synchronous P-channel FET (P-FET) stops switching, and its gate connects to V_{BATT} statically. The P-FET stays off for as long as the voltage across the parasitic C_{DS} (V_{SW}) is lower than V_{BATT} . When the voltage across C_{DS} exceeds V_{BATT} , the synchronous P-FET enters linear mode, allowing the inductor current to decrease and flow into SYS. Once V_{SYS} exceeds V_{BATT} , the P-FET gate is released, and normal closed-loop pulse-width modulation (PWM) operation is initiated. In boost mode, the battery voltage can drop as low as 2.40V without affecting circuit operation.

SYS Disconnect and Inrush Limiting

The MP2637A allows for true output disconnect by eliminating body diode conduction of the internal P-FET rectifier. V_{SYS} can drop to 0V during shutdown, drawing no current from the input source. The MP2637A also allows for inrush current limiting at start-up, minimizing surge currents from the input supply. To optimize the benefits of the output disconnect, avoid connecting an external Schottky diode between SW and SYS.

Board layout is extremely critical for minimizing voltage overshoot at SW due to stray inductance. Keep the output filter capacitor as close as possible to SYS and use very low ESR/ESL ceramic capacitors tied to a good ground plane.

Boost Output Voltage Setting

In boost mode, the MP2637A programs the output voltage via the external resistor divider at FB and provides built-in output OVP to protect the device and other components against damage when V_{SYS} goes beyond 5.55V. Once output over-voltage occurs, the MP2637A turns off the boost converter. When the voltage on V_{SYS} drops to a normal level, the boost converter restarts as long as MODE remains in active status.

Boost Output Current Limiting

The MP2637A integrates a programmable output current limit function in boost mode. If the boost output current exceeds this programmable limit, the output current is limited at this level, and the SYS voltage starts to drop down. OLIM programs the current limit threshold up to 2.4A per Equation (6):

$$I_{OLIM}(A) = \frac{2400}{R_{OLIM}(k\Omega) \times RS1(m\Omega)} \quad (6)$$

SYS Output Over-Current Protection (OCP)

The MP2637A integrates three-phase output OCP.

1. Phase one (boost mode output current limit): When the output current exceeds the programmed output current limit, the output constant current loop controls the output current, the output current remains at its limit of I_{OLIM} , and V_{SYS} decreases.

2. Phase two (down mode): When V_{SYS} drops below $V_{BATT} + 100mV$ and the output current loop remains in control, the boost converter enters down mode and shuts down after $120\mu s$ of blanking time.
3. Phase three (short-circuit mode): When V_{SYS} drops below $3.75V$ ($2V$ during boost soft start), the boost converter shuts down immediately once the inductor current reaches the foldback peak current limit of the low-side N-channel FET (N-FET). The boost converter can also recover automatically after a $1ms$ deglitch period.

Thermal Shutdown Protection

Thermal shutdown protection is also active in boost mode. Once the junction temperature rises higher than $150^{\circ}C$, the MP2637A enters thermal shutdown. The MP2637A does not resume normal operation until the junction temperature drops below $120^{\circ}C$.

APPLICATION INFORMATION

Setting the Charge Current in Charge Mode

In charge mode, both the external sense resistor (RS1) and R_{ISET} connect to ISET to set the charge current (I_{CHG}) of the MP2637A. Given I_{CHG} and RS1, R_{ISET} can be calculated with Equation (7):

$$R_{ISET}(k\Omega) = \frac{2400}{I_{CHG}(A) \times RS1(m\Omega)} \quad (7)$$

For example, if I_{CHG} = 2.5A, and RS1 = 20mΩ, then R_{ISET} = 48kΩ.

Setting the Input Current Limiting in Charge Mode

In charge mode, connect a resistor from ILIM to AGND to program the input current limit. The relationship between the input current limit and setting resistor is shown in Equation (8):

$$R_{ILIM} = \frac{45}{I_{IN_LIM}(A)} (k\Omega) \quad (8)$$

Where R_{ILIM} must exceed 16.5kΩ so that I_{IN_LIM} is in the range of 0A to 2.7A.

For most applications, use R_{ILIM} = 50kΩ (I_{USB_LIM} = 900mA) for USB3.0 mode, and use R_{ILIM} = 90kΩ (I_{USB_LIM} = 500mA) for USB 2.0 mode.

Setting the Input Voltage Range for Different Operation Modes

A resistive voltage divider from the input to PWIN determines the operating mode of MP2637A and can be calculated with Equation (9):

$$V_{PWIN} = V_{IN} \times \frac{R6}{R4 + R6} (V) \quad (9)$$

If the voltage on PWIN is between 0.77V and 1.10V, the MP2637A works in charge mode. When the voltage on PWIN is outside the range of 0.77V to 1.10V and V_{IN} > 2V, the MP2637A works in boost mode (see Table 1).

For a wide operating range, use a maximum input voltage of 5.74V as the upper threshold for a voltage ratio shown in Equation (10):

$$\frac{V_{PWIN}}{V_{IN}} = \frac{1.10}{5.74} = \frac{R6}{R4 + R6} \quad (10)$$

With the given R6, R4 can then be calculated with Equation (11):

$$R4 = \frac{V_{IN} - V_{PWIN}}{V_{PWIN}} \times R6 \quad (11)$$

For a typical application, start with R6 = 5.1kΩ. R4 is then 21.5kΩ.

Setting the Input Voltage Regulation in Charge Mode

In charge mode, connect a resistor divider from VIN to AGND tapped to REG to program the input voltage regulation. Calculate V_{IN_R} with Equation (12):

$$V_{IN_R} = V_{REG} \times \frac{R3 + R5}{R5} (V) \quad (12)$$

With a given R5, R3 can then be calculated with Equation (13):

$$R3 = \frac{V_{IN_R} - V_{REG}}{V_{REG}} \times R5 (V) \quad (13)$$

For a preset input voltage regulation value (i.e.: 4.75V), start with R5 = 5.1kΩ. R3 is then 15.8kΩ.

NTC Function in Charge Mode

Figure 14 shows that an internal resistor divider sets the low temperature threshold (V_{TL}) and high temperature threshold (V_{TH}) at 66.6% · V_{SYS} and 35% · V_{SYS}, respectively.

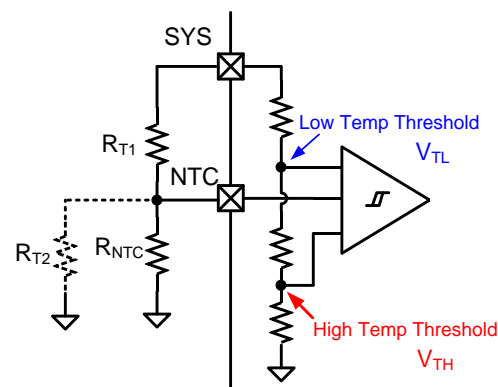

Figure 14: NTC Function Block

For a given NTC thermistor, select an appropriate R_{T1} and R_{T2} to set the NTC window with Equation (14) and Equation (15):

$$\frac{V_{TL}}{V_{SYS}} = \frac{R_{T2} // R_{NTC_Cold}}{R_{T1} + R_{T2} // R_{NTC_Cold}} = TL = 66.6\% \quad (14)$$

$$\frac{V_{TH}}{V_{SYS}} = \frac{R_{T2} // R_{NTC_Hot}}{R_{T1} + R_{T2} // R_{NTC_Hot}} = TH = 35\% \quad (15)$$

Where R_{NTC_Hot} is the value of the NTC resistor at the upper bound of its operating temperature range, and R_{NTC_Cold} is its lower bound.

The two resistors, R_{T1} and R_{T2} , determine the upper and lower temperature limits independently. This flexibility allows the MP2637A to operate with most NTC resistors for different temperature range requirements.

Calculate R_{T1} and R_{T2} with Equation (16) and Equation (17):

$$R_{T1} = \frac{R_{NTC_Hot} \times R_{NTC_Cold} \times (TL - TH)}{TH \times TL \times (R_{NTC_Cold} - R_{NTC_Hot})} \quad (16)$$

$$R_{T2} = \frac{(TL - TH) \times R_{NTC_Cold} \times R_{NTC_Hot}}{(1 - TL) \times TH \times R_{NTC_Cold} - (1 - TH) \times TL \times R_{NTC_Hot}} \quad (17)$$

For example, the NCP18XH103 thermistor has the following electrical characteristics:

- At 0°C, $R_{NTC_Cold} = 27.445k\Omega$
- At 50°C, $R_{NTC_Hot} = 4.1601k\Omega$.

Based on Equation (16) and Equation (17), $R_{T1} = 6.65k\Omega$ and $R_{T2} = 25.63k\Omega$ are suitable for an NTC window between 0°C and 50°C. Chose approximate values (e.g. $R_{T1} = 6.65k\Omega$ and $R_{T2} = 25.5k\Omega$).

If no external NTC is available, connect R_{T1} and R_{T2} to keep the voltage on NTC within the valid NTC window (e.g.: $R_{T1} = R_{T2} = 10k\Omega$).

For convenience, an NTC thermistor design spreadsheet has been provided.

Setting the System Voltage in Boost Mode

In boost mode, the system voltage can be regulated to the customer-required value between 4.2V to 6V by the resistor divider at FB. Calculate V_{SYS} with Equation (18):

$$V_{SYS} = 1.15 \times \frac{R1 + R2}{R2} \quad (18)$$

Where 1.15V is the voltage reference of SYS. With a typical value for $R2$ (10kΩ), $R1$ can be determined with Equation (19):

$$R1 = R2 \times \frac{V_{SYS} - 1.15}{1.15} \quad (19)$$

For example, for a 5V system voltage, $R2$ is 10kΩ, and $R1$ is 33kΩ.

Setting the Output Current Limit in Boost Mode

In boost mode, connect a resistor from OLIM to AGND to program the output current limit. The relationship between the output current limit and setting resistor is shown in Equation (20):

$$I_{OLIM}(A) = \frac{2400}{R_{OLIM}(k\Omega) \times RS1(m\Omega)} \quad (20)$$

The output current limit of the boost can be programmed up to 2.1A (min). Considering a 10% output current limit accuracy, a 2.3A output current limit is required, typically. According to Equation (20), given a 20mΩ sense resistor, a 52kΩ R_{OLIM} can achieve a 2.3A output current limit.

For safe operation, R_{OLIM} *cannot* be lower than 47.5kΩ

Selecting the Inductor

Inductor selection is a trade-off between cost, size, and efficiency. A lower inductance value results in a smaller size but also has higher current ripple, higher magnetic hysteretic losses, and higher output capacitances. However, a higher inductance value results in lower ripple current and smaller output filter capacitors but also has higher inductor DC resistance (DCR) loss. Choose an inductor that does not saturate under the worst-case load condition.

1. Selecting an Inductor in Charge Mode

When the MP2637A works in charge mode (as a buck converter), estimate the required inductance with Equation (21):

$$L = \frac{V_{IN} - V_{BATT}}{\Delta I_{L_MAX}} \times \frac{V_{BATT}}{V_{IN} \times f_{SW}} \quad (21)$$

Where V_{IN} is the typical input voltage, V_{BATT} is the typical CC charge threshold, f_s is the typical switching frequency, and ΔI_{L_MAX} is the maximum peak-to-peak inductor current (usually designed at 30 - 40% of the CC charge current).

With a typical 5V input voltage, a 35% inductor current ripple at the corner point between the trickle charge and CC charge ($V_{BATT} = 3V$, $I_{chg} = 2.5A$), the inductance 2.2 μ H.

2. Selecting an Inductor in Boost Mode

When the MP2637A is in boost mode (as a boost converter), the required inductance value can be calculated with Equation (22), Equation (23), and Equation (24):

$$L = \frac{V_{BATT} \times (V_{SYS} - V_{BATT})}{V_{SYS} \times f_{SW} \times \Delta I_{L_MAX}} \quad (22)$$

$$\Delta I_{L_MAX} = (30\% - 40\%) \times I_{BATT(MAX)} \quad (23)$$

$$I_{BATT(MAX)} = \frac{V_{SYS} \times I_{SYS}}{V_{BATT} \times \eta} \quad (24)$$

Where V_{BATT} is the minimum battery voltage, f_{SW} is the switching frequency, and ΔI_{L_MAX} is the peak-to-peak inductor ripple current (approximately 30% of the maximum battery current $I_{BATT(MAX)}$), $I_{SYS(MAX)}$ is the system current, and η is the efficiency.

In the worst-case scenario where the battery voltage is 3V, a 30% inductor current ripple, and a typical system voltage ($V_{SYS} = 5V$), the inductance is 1.5 μ H when the efficiency is 90%.

For best results, use an inductor with an inductance of 2.2 μ H and a DC current rating no lower than the peak current of the FET. For higher efficiency, minimize the inductor's DC resistance.

Selecting the Input Capacitor (C_{IN})

The input capacitor (C_{IN}) reduces both the surge current drawn from the input and the switching noise from the device. The input capacitor impedance at the switching frequency should be less than the input source impedance to prevent high-frequency switching current from passing to the input. For best results, ceramic capacitors with X7R dielectrics are recommended for their low ESR and small

temperature coefficients. For most applications, a 22 μ F capacitor is sufficient.

Selecting the System Capacitor (C_{SYS})

Select C_{SYS} based on the demand of the system current ripple.

1. Selecting a System Cap in Charge Mode

C_{SYS} acts as the input capacitor of the buck converter in charge mode. The input current ripple can be calculated with Equation (25):

$$I_{RMS_MAX} = I_{SYS_MAX} \times \frac{\sqrt{V_{TC} \times (V_{IN_MAX} - V_{TC})}}{V_{IN_MAX}} \quad (25)$$

2. Selecting a System Cap in Boost Mode

C_{SYS} is the output capacitor of boost converter. C_{SYS} keeps the system voltage ripple small and ensures feedback loop stability. The system current ripple is given by Equation (26):

$$I_{RMS_MAX} = I_{SYS_MAX} \times \frac{\sqrt{V_{TC} \times (V_{SYS_MAX} - V_{TC})}}{V_{SYS_MAX}} \quad (26)$$

Since the input voltage is passed to the system directly, $V_{IN_MAX} = V_{SYS_MAX}$, and both charge mode and boost mode have the same system current ripple.

For $I_{CC_MAX} = 2A$, $V_{TC} = 3V$, $V_{IN_MAX} = 6V$, the maximum ripple current is 1.25A. Select the system capacitors based on the ripple-current temperature rise not exceeding 10°C. For best results, use ceramic capacitors with X7R dielectrics with low ESR and small temperature coefficients. For most applications, use three 22 μ F capacitors.

Selecting the Battery Capacitor (C_{BATT})

C_{BATT} is in parallel with the battery to absorb the high-frequency switching ripple current.

1. Selecting a Battery Cap in Charge Mode

C_{BATT} is the output capacitor of the buck converter. The output voltage ripple can be calculated with Equation (27):

$$\Delta r_{BATT} = \frac{\Delta V_{BATT}}{V_{BATT}} = \frac{1 - V_{BATT}/V_{SYS}}{8 \times C_{BATT} \times f_{SW}^2 \times L} \quad (27)$$

2. Selecting a Battery Cap in Boost Mode

C_{BATT} is the input capacitor of the boost converter. The input voltage ripple is the same as the output voltage ripple from Equation (27).

Both charge mode and boost mode have the same battery voltage ripple. C_{BATT} can be calculated with Equation (28):

$$C_{BATT} = \frac{1 - V_{TC} / V_{SYS_MAX}}{8 \times \Delta r_{BATT_MAX} \times f_{SW}^2 \times L} \quad (28)$$

To guarantee a ±0.5% BATT voltage accuracy, the maximum BATT voltage ripple must not exceed 0.5% (e.g.: 0.2%). The worst-case scenario occurs at the minimum battery voltage of the CC charge with the maximum input voltage.

For V_{SYS_MAX} = 6V, V_{CC_MIN} = V_{TC} = 3V, L = 2.2µH, f_{SW} = 600kHz, Δr_{BATT_MAX} = 0.2%, and C_{BATT} is 39µF.

Two 22µF ceramic capacitors with X7R dielectrics capacitor in parallel are sufficient.

PCB Layout Guidelines

Efficient PCB layout is critical for specified noise, efficiency, and stability requirements. For best results, refer to Figure 15 and follow the guidelines below.

1. Route the power stage adjacent to its ground.
2. Minimize the high-side switching node (SW, inductor) trace lengths in the high-current paths.
3. Keep the switching node short and away from all small control signals, especially the feedback network.
4. Place the input capacitor as close to VIN and PGND as possible.
5. Place the local power input capacitors connected from SYS to PGND as close to the IC as possible.
6. Place the output inductor close to the IC.
7. Connect the output capacitor between the inductor and PGND of the IC.

8. Connect the power pads for IN, SYS, SW, BATT, and PGND to as many coppers planes on the board as possible for high-current applications.

This improves thermal performance because the board conducts heat away from the IC.

9. Connect a ground plane to the PCB directly to the return of all components through vias (e.g.: two vias per capacitor for power-stage capacitors, one via per capacitor for small-signal components).

10. Use a star ground design approach to keep circuit block currents isolated (power-signal/control-signal).

This reduces noise coupling and ground-bounce issues. A single ground plane for this design gives good results.

11. Place ISET, OLIM, and ILIM resistors very close to their respective IC pins.

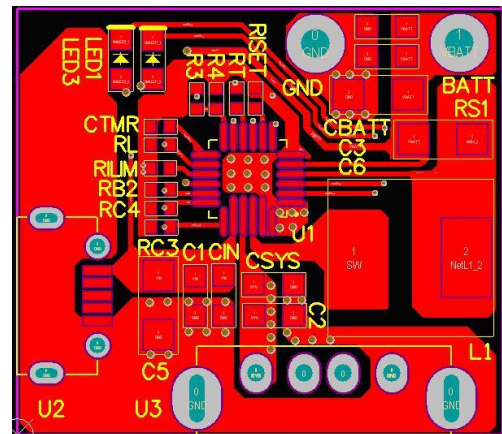

Top Layer

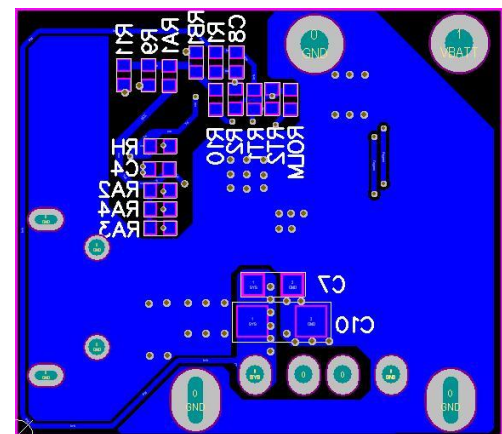

Bottom Layer

Figure 15: PCB Layout Example (Board Size is 22x25mm)

Design Example

Table 3 is a design example following the application guidelines for the specifications below.

Table 3: Design Example

V_{IN}	5V/500mA for USB 5V/3A for adapter
Charge	3.7V / 2.5A
Discharge	4.78V / 2.1A
f_{sw}	600kHz

Figure 16 shows the detailed application schematic. The typical performance characteristics section shows the typical performance and circuit waveforms. For more possible applications of this device, please refer to the related evaluation board datasheet.

TYPICAL APPLICATION CIRCUIT

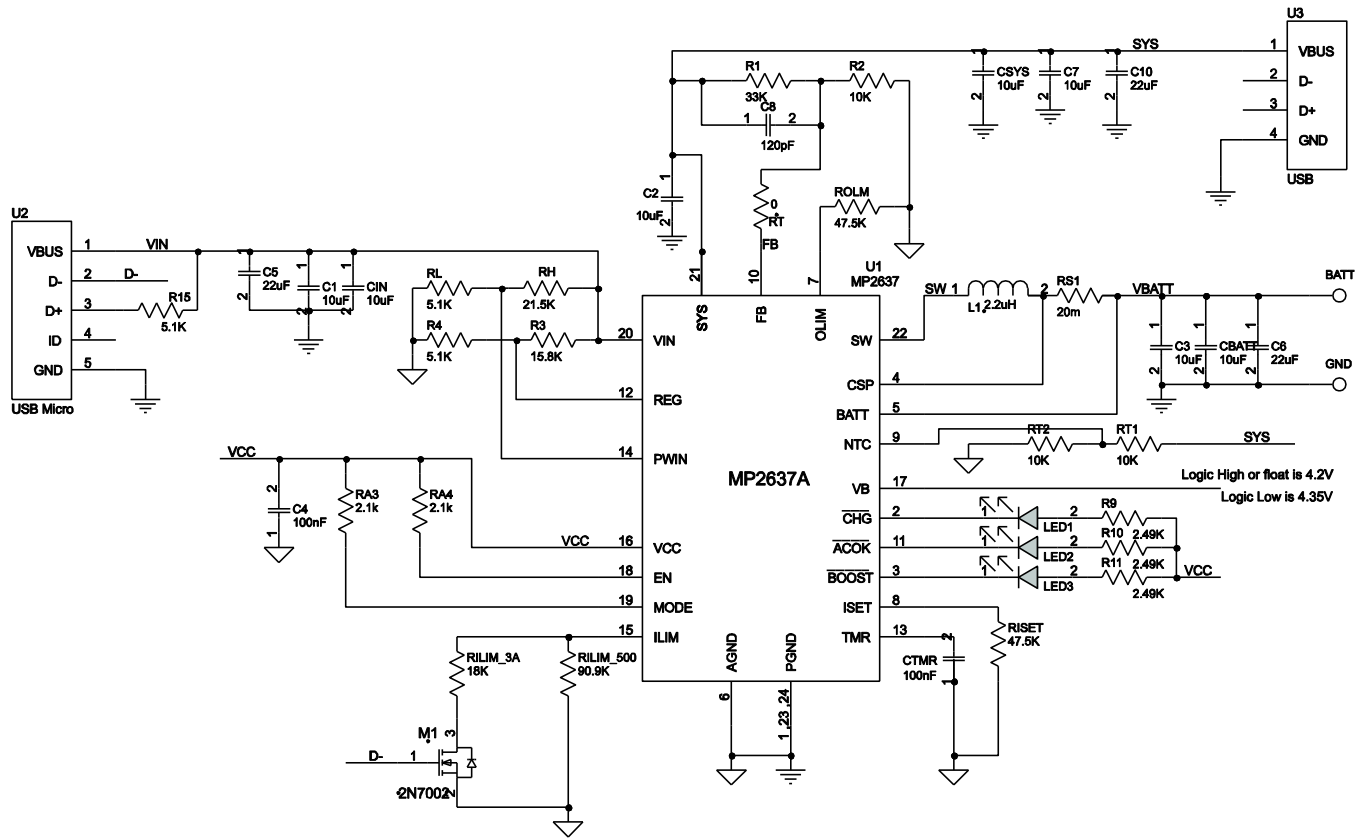
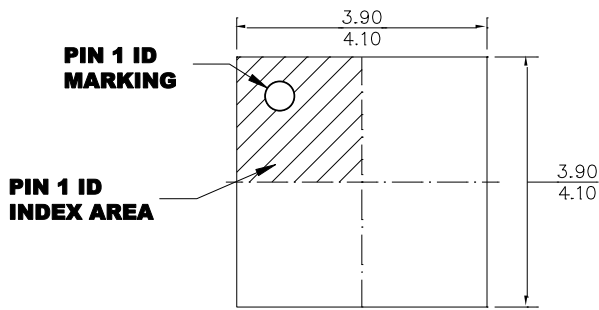

Figure 16: Typical Application Circuit of MP2637A with USB Connectors

PACKAGE INFORMATION

QFN-24 (4mmx4mm)



TOP VIEW

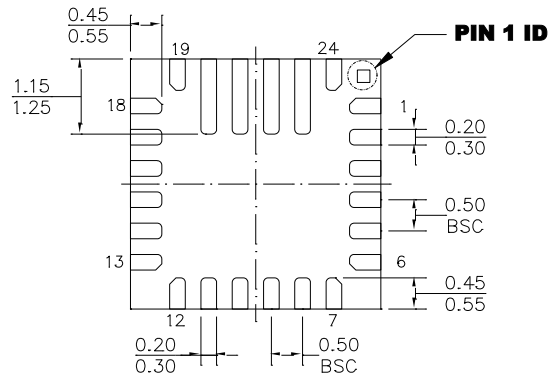

BOTTOM VIEW

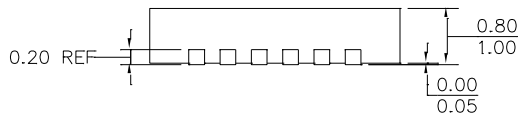

SIDE VIEW

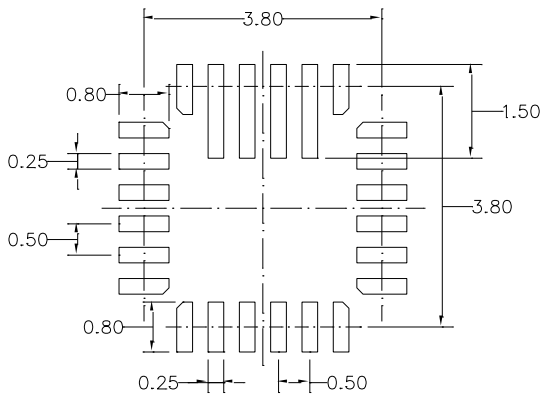

RECOMMENDED LAND PATTERN

NOTE:

- 1) ALL DIMENSIONS ARE IN MILLIMETERS.
- 2) EXPOSED PADDLE SIZE DOES NOT INCLUDE MOLD FLASH.
- 3) LEAD COPLANARITY SHALL BE 0.10 MILLIMETERS MAX.
- 4) JEDEC REFERENCE IS MO-220.
- 5) DRAWING IS NOT TO SCALE.

NOTICE: The information in this document is subject to change without notice. Users should warrant and guarantee that third party Intellectual Property rights are not infringed upon when integrating MPS products into any application. MPS will not assume any legal responsibility for any said applications.

Компания «Океан Электроники» предлагает заключение долгосрочных отношений при поставках импортных электронных компонентов на взаимовыгодных условиях!

Наши преимущества:

- Поставка оригинальных импортных электронных компонентов напрямую с производств Америки, Европы и Азии, а так же с крупнейших складов мира;
- Широкая линейка поставок активных и пассивных импортных электронных компонентов (более 30 млн. наименований);
- Поставка сложных, дефицитных, либо снятых с производства позиций;
- Оперативные сроки поставки под заказ (от 5 рабочих дней);
- Экспресс доставка в любую точку России;
- Помощь Конструкторского Отдела и консультации квалифицированных инженеров;
- Техническая поддержка проекта, помощь в подборе аналогов, поставка прототипов;
- Поставка электронных компонентов под контролем ВП;
- Система менеджмента качества сертифицирована по Международному стандарту ISO 9001;
- При необходимости вся продукция военного и аэрокосмического назначения проходит испытания и сертификацию в лаборатории (по согласованию с заказчиком);
- Поставка специализированных компонентов военного и аэрокосмического уровня качества (Xilinx, Altera, Analog Devices, Intersil, Interpoint, Microsemi, Actel, Aeroflex, Peregrine, VPT, Syfer, Eurofarad, Texas Instruments, MS Kennedy, Miteq, Cobham, E2V, MA-COM, Hittite, Mini-Circuits, General Dynamics и др.);

Компания «Океан Электроники» является официальным дистрибьютором и эксклюзивным представителем в России одного из крупнейших производителей разъемов военного и аэрокосмического назначения «JONHON», а так же официальным дистрибьютором и эксклюзивным представителем в России производителя высокотехнологичных и надежных решений для передачи СВЧ сигналов «FORSTAR».



JONHON

«JONHON» (основан в 1970 г.)

Разъемы специального, военного и аэрокосмического назначения:

(Применяются в военной, авиационной, аэрокосмической, морской, железнодорожной, горно- и нефтедобывающей отраслях промышленности)

«FORSTAR» (основан в 1998 г.)

ВЧ соединители, коаксиальные кабели,
кабельные сборки и микроволновые компоненты:

(Применяются в телекоммуникациях гражданского и специального назначения, в средствах связи, РЛС, а так же военной, авиационной и аэрокосмической отраслях промышленности).



Телефон: 8 (812) 309-75-97 (многоканальный)

Факс: 8 (812) 320-03-32

Электронная почта: ocean@oceanchips.ru

Web: <http://oceanchips.ru/>

Адрес: 198099, г. Санкт-Петербург, ул. Калинина, д. 2, корп. 4, лит. А