

TEC Series

Wakefield-Vette's **Peltier, thermoelectric coolers** can meet the requirement of higher current and large cooling. It is often applied to experimental, scientific and biomedical instruments, laboratory equipment, industry and electrical equipment and consumables. The ambient temperature can arrive 100C, long-term working temperature is recommended to be below 90C.



Features:

- All products are RoHS and REACH compliant, SGS ISO9001 verified
- Thermoelectric module material are UL certification
- Standard Wire is 150mm
- Thermoelectric module moisture protection standard is sealed by white RTV silicone, but also support select other moisture protection style, Such as translucent silicone, black epoxy.
- Thermoelectric module flatness tolerance support select 0.2mm, 0.13mm, 0.1mm.

WKV Part Number	Description	Current max (A)	Q max (W) @ 27°C	V max (V) @ 27°C	ΔT max (°C) @ 27°C	# of Couples	Outline (L/W/)	Height (mm)
TEC-30-40-127	PELTIER TEC 30X30 4MM 2.5A	2.5	21.4	15.4	68	127	30x30	4
TEC-30-32-127	PELTIER TEC 30X30 3.2MM 3.9A	3.9	33.4	15.4	68	127	30x30	3.2
TEC-40-47-127	PELTIER TEC 40X40 4.7MM 3.9A	3.9	33.4	15.4	69	127	40x40	4.7
TEC-40-33-127	PELTIER TEC 40X40 3.3MM 8.5A	8.5	72	15.4	69	127	40x40	3.3
TEC-30-36-127	PELTIER TEC 30X30 3.6MM 3.0A	3.0	25.7	15.4	68	127	30x30	3.6
TEC-30-47-71	PELTIER TEC 30X30 4.7MM 3.9A	3.9	18.7	8.6	69	71	30x30	4.7
TEC-30-38-71	PELTIER TEC 30X30 3.8MM 6.0A	6.0	28.7	8.6	69	71	30x30	3.8
TEC-40-38-127	PELTIER TEC 40X40 3.8MM 6.0A	6.0	51.4	15.4	69	127	40x40	3.8
TEC-20-33-31	PELTIER TEC 20X20 3.3MM 8.5A	8.5	16.8	3.75	69	31	20x20	3.3
TEC-30-33-71	PELTIER TEC 30X30 3.3MM 8.5A	8.5	72	15.4	69	71	30x30	3.3

Thermoelectric Cooler Performance Specifications



TEC-40-47-127

Hot Side Temperature(°C)	25 °C	50 °C
Qmax (Watts)	33.4	39
Delta Tmax(°C)	67	75
Imax (Amps)	4	4
Vmax (Volts)	15.4	16.4
ModuleResistance(Ohms)	3.22	3.63



**Tolerances for thermal and electrical parameters $\pm 10\%$.

Performance Curves Th=25 °C

Performance Curves Th=50 °C



Mechanical Drawing:



Operation Tips:

- **Maximum Operating Temperature: 90°C**
- **Do not exceed I_{max} or V_{max} when operating module**
- **Please consult Wakefield-Vette for moisture and corrosion protection options as well as specific application inquiries**

Thermoelectric Cooler Performance Specifications



TEC-30-32-127

Hot Side Temperature(°C)	25 °C	50 °C
Qmax (Watts)	33.4	36.6
Delta Tmax(°C)	67	75
I _{max} (Amps)	3.9	3.9
V _{max} (Volts)	15.4	16.4
Module Resistance(Ohms)	3.37	3.8

**Tolerances for thermal and electrical parameters ± 10%.

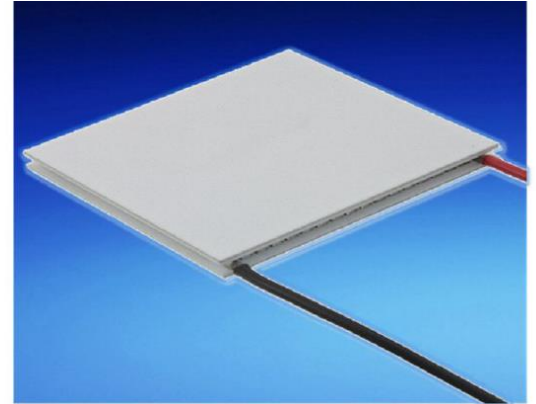

Performance Curves Th=25 °C

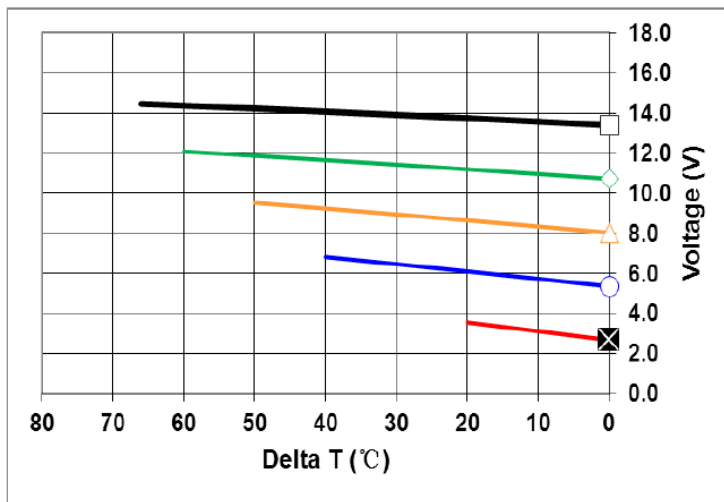

Performance Curves Th=50 °C

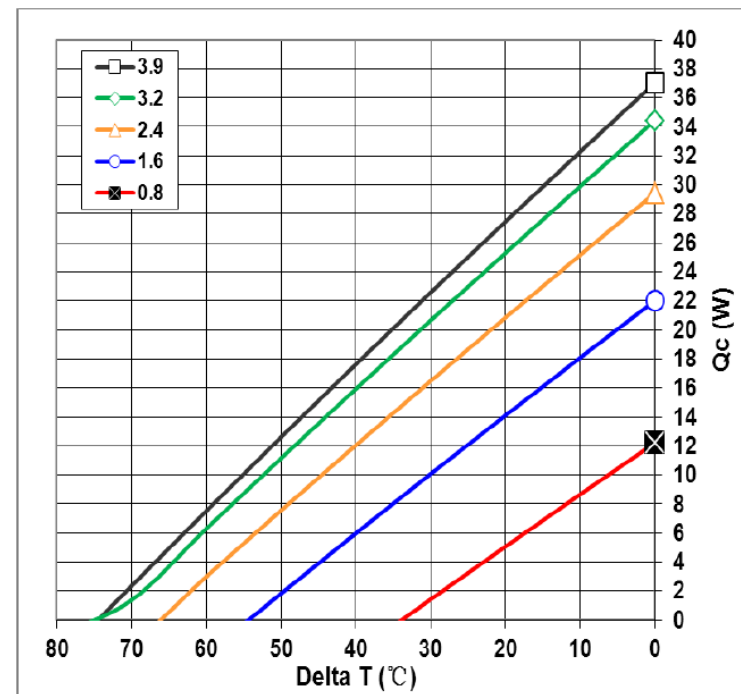
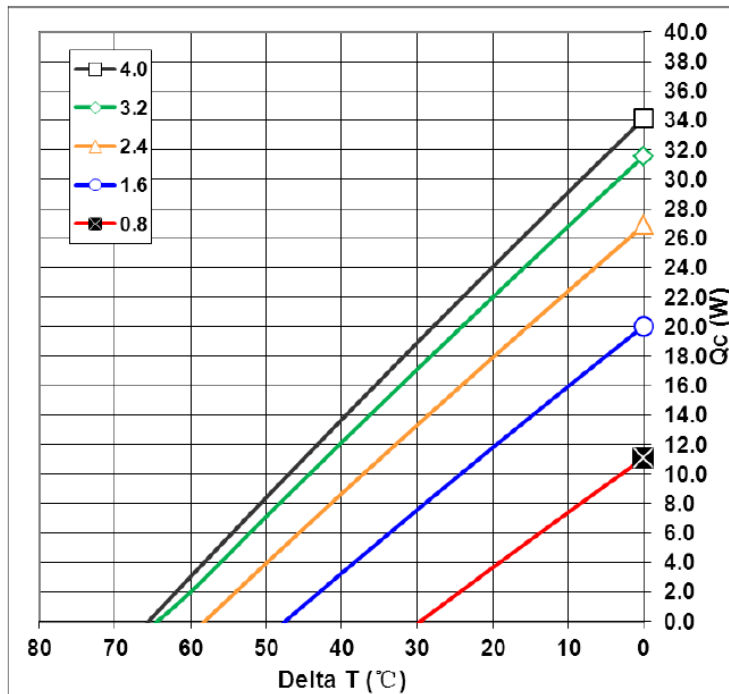
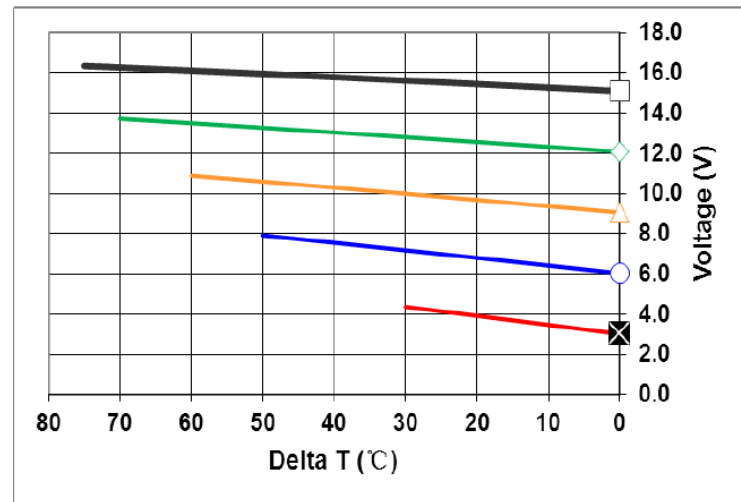

Mechanical Drawing:



Operation Tips:

- **Maximum Operating Temperature: 90°C**
- **Do not exceed I_{max} or V_{max} when operating module**
- **Please consult Wakefield-Vette for moisture and corrosion protection options as well as specific application inquiries**

Thermoelectric Cooler Performance Specifications



TEC-30-40-127

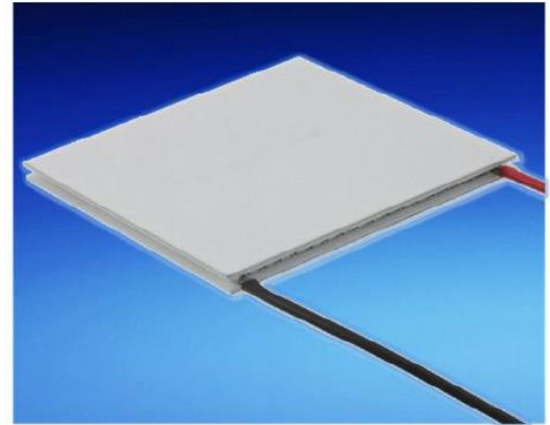

Hot Side Temperature(°C)	25 °C	50 °C
Qmax (Watts)	21.4	23.6
Delta Tmax(°C)	67	75
I _{max} (Amps)	2.5	2.5
V _{max} (Volts)	15.4	16.4
Module Resistance(Ohms)	5.38	6.07

**Tolerances for thermal and electrical parameters ± 10%.

Performance Curves Th=25 °C

Performance Curves Th=50 °C

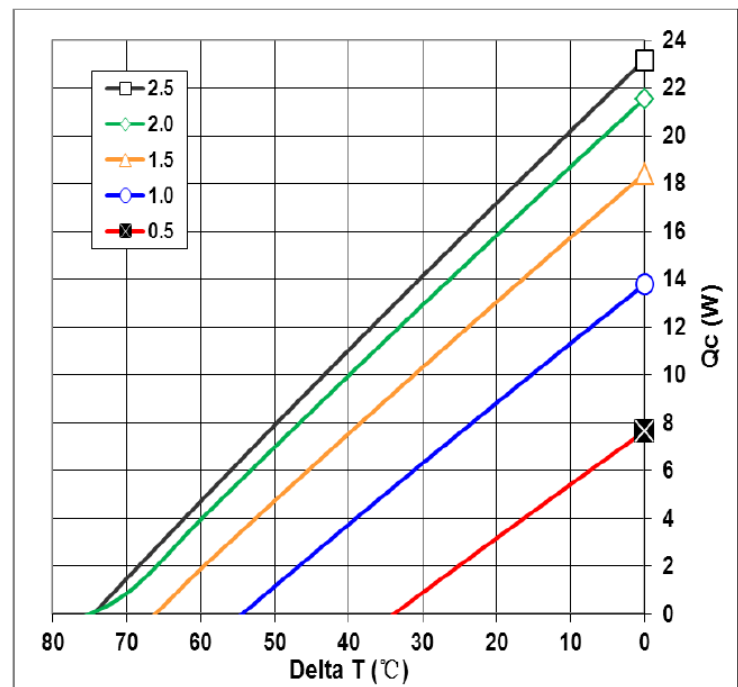
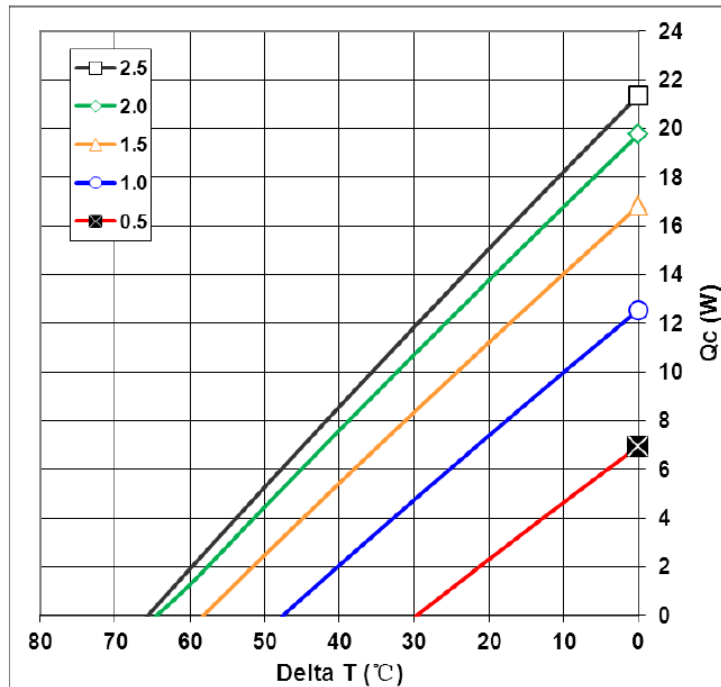
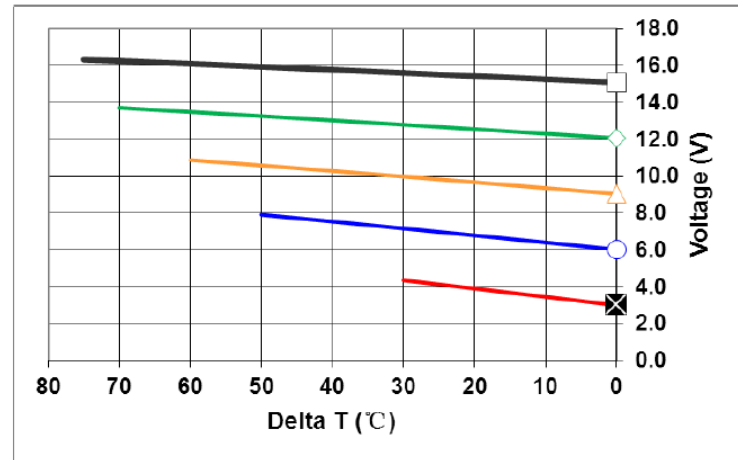
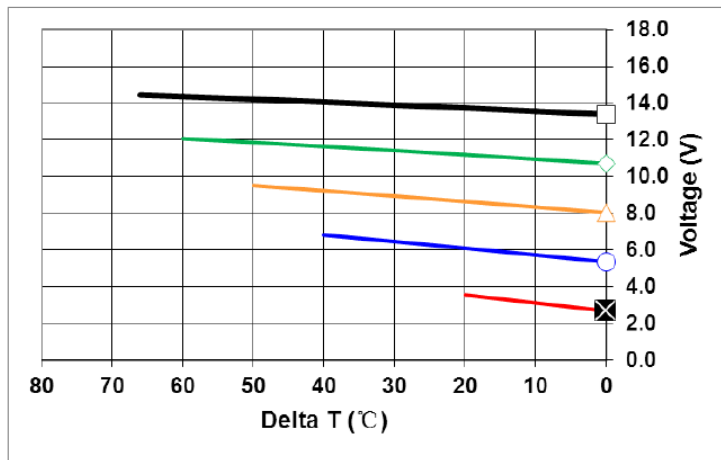

Wakefield-Vette reserves the right to change these specifications without notice

Mechanical Drawing:



Operation Tips:

- **Maximum Operating Temperature: 90°C**
- **Do not exceed I_{max} or V_{max} when operating module**
- **Please consult Wakefield-Vette for moisture and corrosion protection options as well as specific application inquiries**

Thermoelectric Cooler Performance Specifications



TEC-40-33-127

Hot Side Temperature(°C)	25 °C	50 °C
Qmax (Watts)	72	82
Delta Tmax(°C)	67	75
I _{max} (Amps)	8.5	8.5
V _{max} (Volts)	15.4	16.4
Module Resistance(Ohms)	1.54	1.74

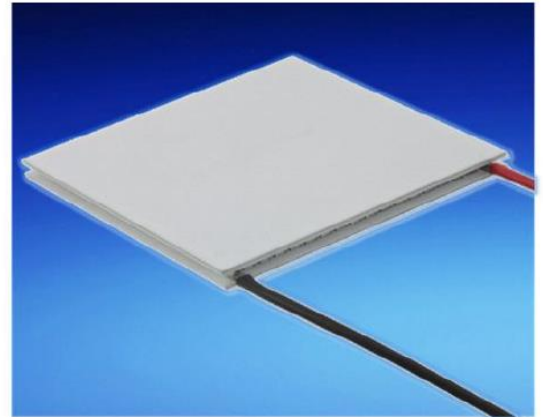

**Tolerances for thermal and electrical parameters ± 10%.

Performance Curves Th=25 °C

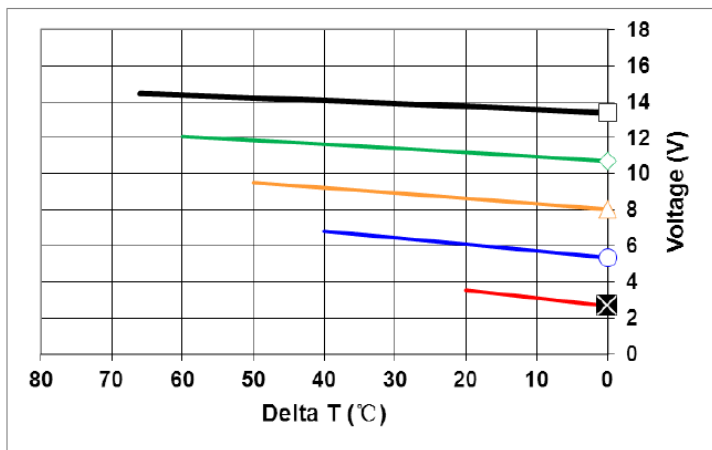

Performance Curves Th=50 °C



Mechanical Drawing:

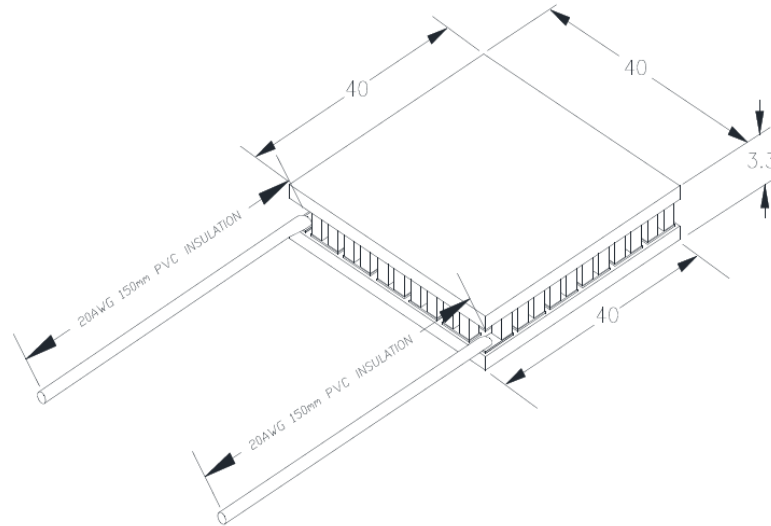

Operation Tips:

- **Maximum Operating Temperature: 90°C**
- **Do not exceed I_{max} or V_{max} when operating module**
- **Please consult Wakefield-Vette for moisture and corrosion protection options as well as specific application inquiries**

Thermoelectric Cooler Performance Specifications



TEC-30-36-127

Hot Side Temperature(°C)	25 °C	50 °C
Qmax (Watts)	25.7	29.8
Delta Tmax(°C)	67	75
I _{max} (Amps)	3	3
V _{max} (Volts)	15.4	16.4
Module Resistance(Ohms)	4.16	4.69

**Tolerances for thermal and electrical parameters ± 10%.



Performance Curves Th=25 °C



Performance Curves Th=50 °C



Mechanical Drawing:

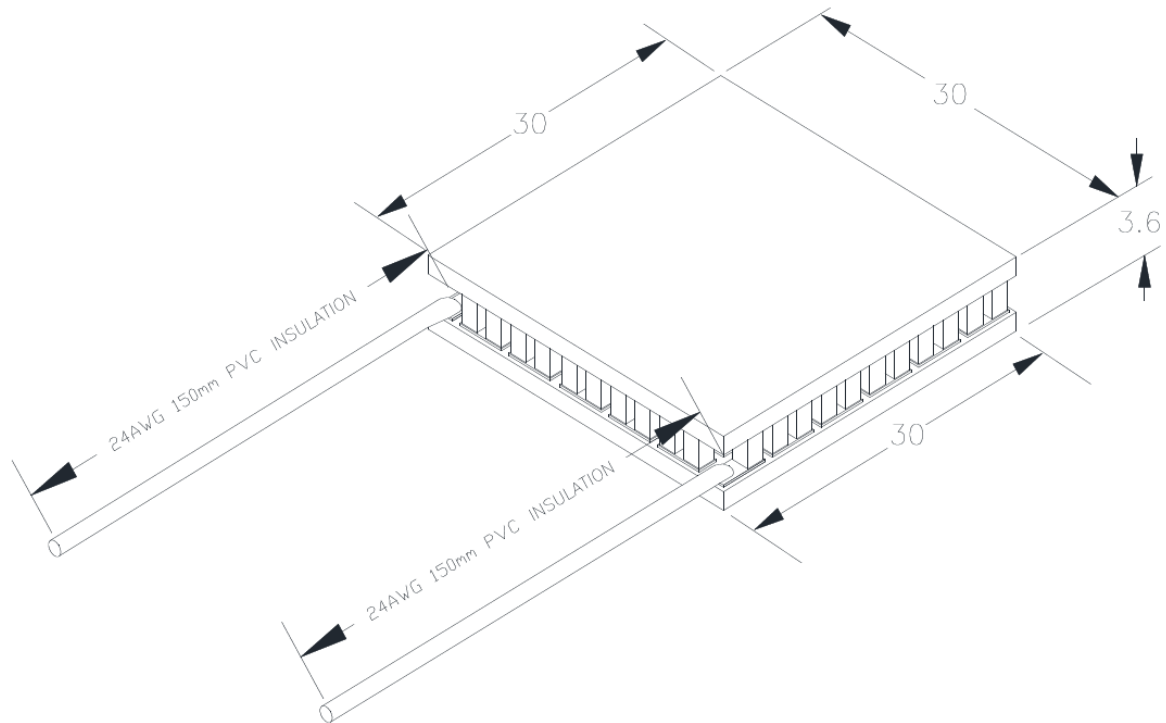

Operation Tips:

- **Maximum Operating Temperature: 90°C**
- **Do not exceed I_{max} or V_{max} when operating module**
- **Please consult Wakefield-Vette for moisture and corrosion protection options as well as specific application inquiries**

Thermoelectric Cooler Performance Specifications



TEC-30-47-71

Hot Side Temperature(°C)	25 °C	50 °C
Qmax (Watts)	18.7	21.9
Delta Tmax(°C)	67	75
I _{max} (Amps)	4	4
V _{max} (Volts)	8.6	9.6
Module Resistance(Ohms)	1.8	2.1

**Tolerances for thermal and electrical parameters ± 10%.



Performance Curves Th=25 °C

Performance Curves Th=50 °C



Mechanical Drawing:



Operation Tips:

- **Maximum Operating Temperature: 90°C**
- **Do not exceed I_{max} or V_{max} when operating module**
- **Please consult Wakefield-Vette for moisture and corrosion protection options as well as specific application inquiries**

Thermoelectric Cooler Performance Specifications



TEC-30-38-71

Hot Side Temperature(°C)	25 °C	50 °C
Qmax (Watts)	28.7	31.2
Delta Tmax(°C)	67	75
I _{max} (Amps)	6	6
V _{max} (Volts)	8.6	9.5
Module Resistance(Ohms)	0.55	0.62



**Tolerances for thermal and electrical parameters ± 10%.

Performance Curves Th=25 °C



Performance Curves Th=50 °C

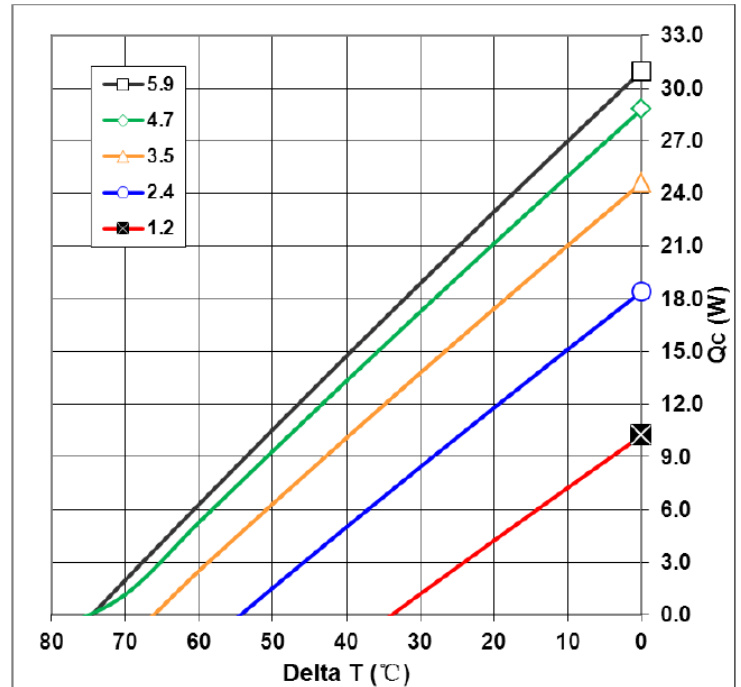
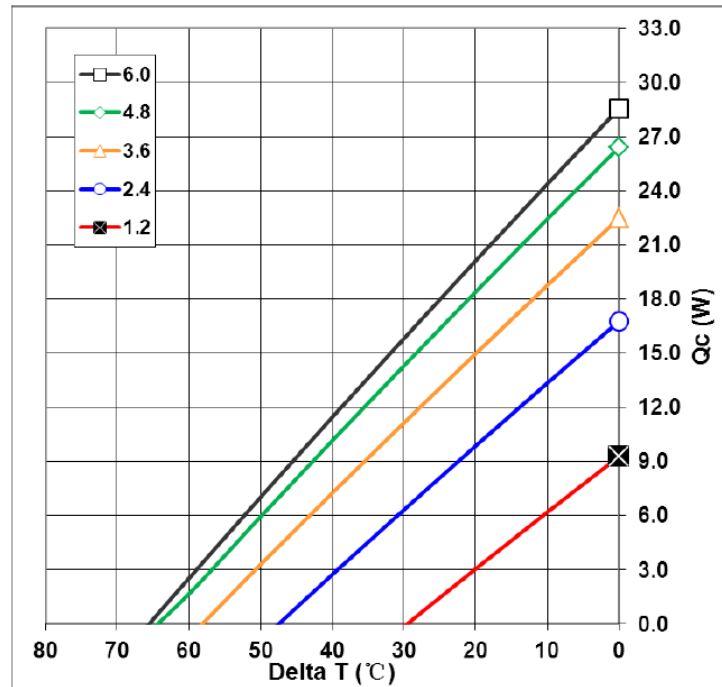
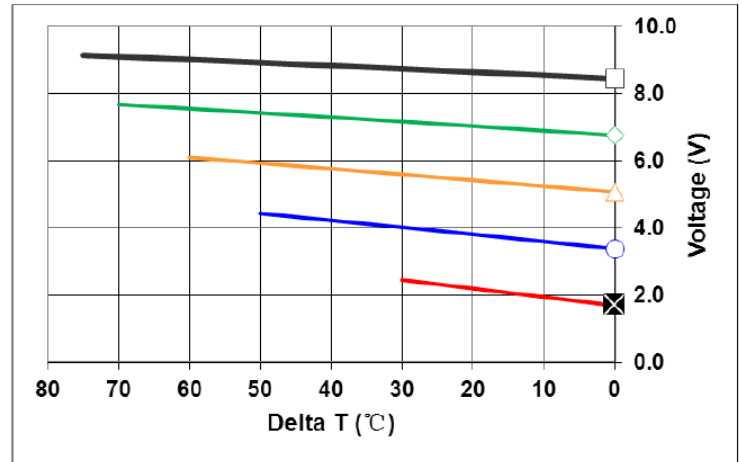

Mechanical Drawing:



Operation Tips:

- **Maximum Operating Temperature: 90°C**
- **Do not exceed I_{max} or V_{max} when operating module**
- **Please consult Wakefield-Vette for moisture and corrosion protection options as well as specific application inquiries**

Thermoelectric Cooler Performance Specifications



TEC-40-38-127

Hot Side Temperature(°C)	25 °C	50 °C
Qmax (Watts)	51.4	55
Delta Tmax(°C)	67	75
I _{max} (Amps)	6	6
V _{max} (Volts)	15.4	16.4
Module Resistance(Ohms)	2.25	2.54

**Tolerances for thermal and electrical parameters ± 10%.

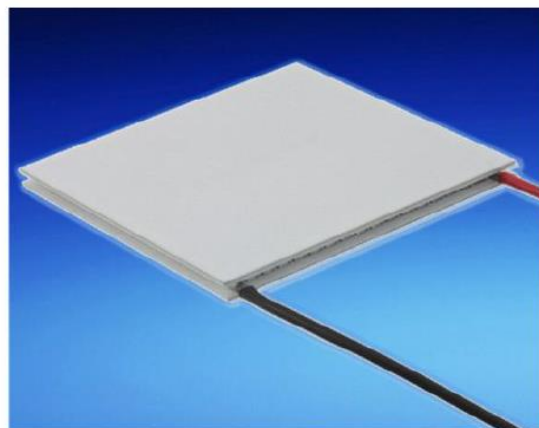

Performance Curves Th=25 °C

Performance Curves Th=50 °C

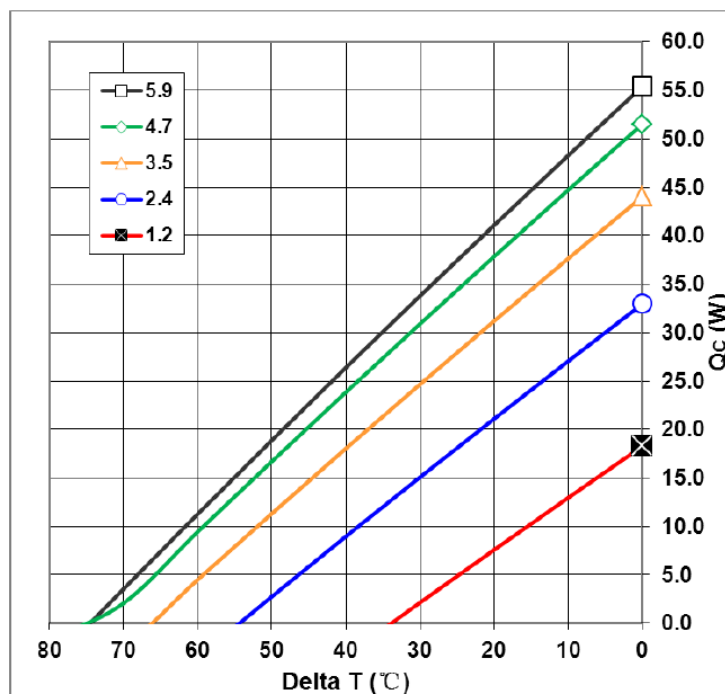
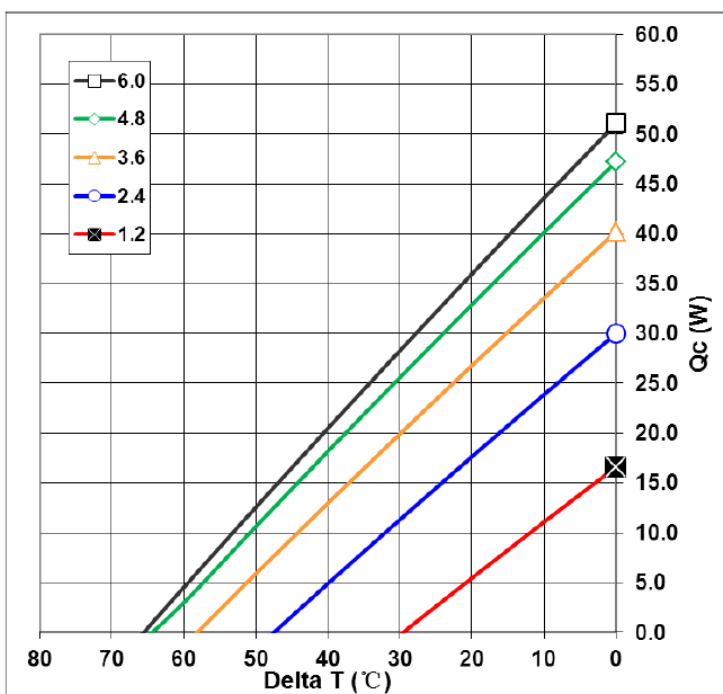
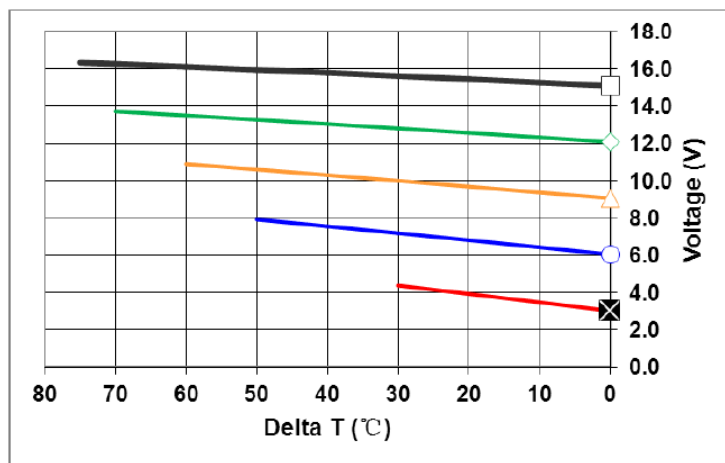
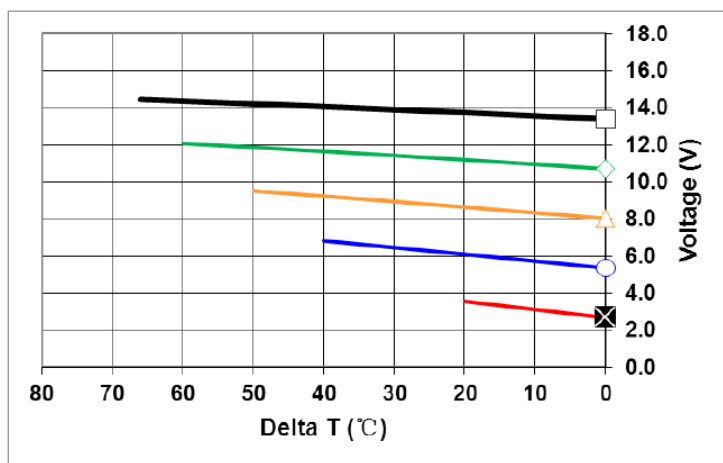

Wakefield-Vette reserves the right to change these specifications without notice

Mechanical Drawing:



Operation Tips:

- **Maximum Operating Temperature: 90°C**
- **Do not exceed I_{max} or V_{max} when operating module**
- **Please consult Wakefield-Vette for moisture and corrosion protection options as well as specific application inquiries**

Thermoelectric Cooler Performance Specifications



TEC-20-33-31

Hot Side Temperature(°C)	25 °C	50 °C
Qmax (Watts)	16.8	20.3
Delta Tmax(°C)	67	75
I _{max} (Amps)	8.5	8.5
V _{max} (Volts)	3.75	4.1
Module Resistance(Ohms)	0.38	0.42

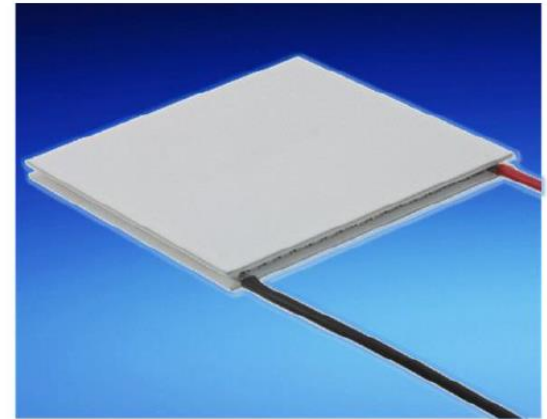

**Tolerances for thermal and electrical parameters ± 10%.

Performance Curves Th=25 °C

Performance Curves Th=50 °C

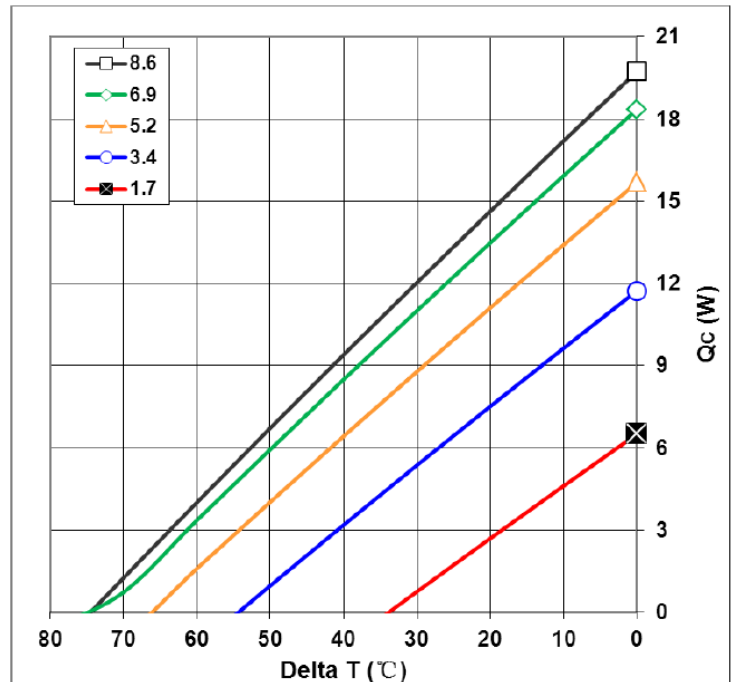
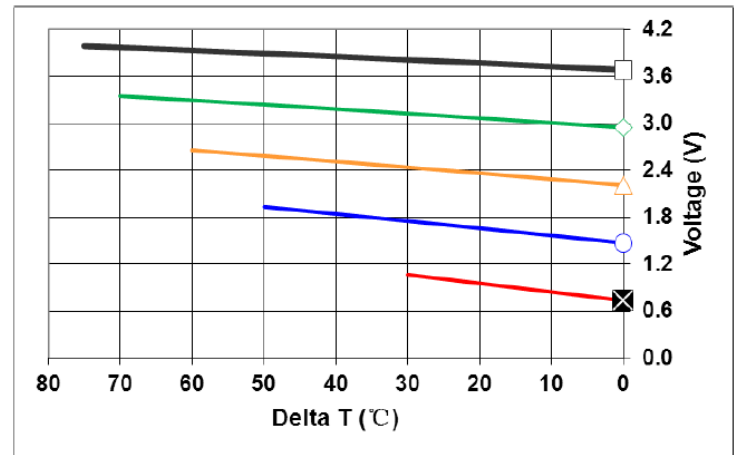
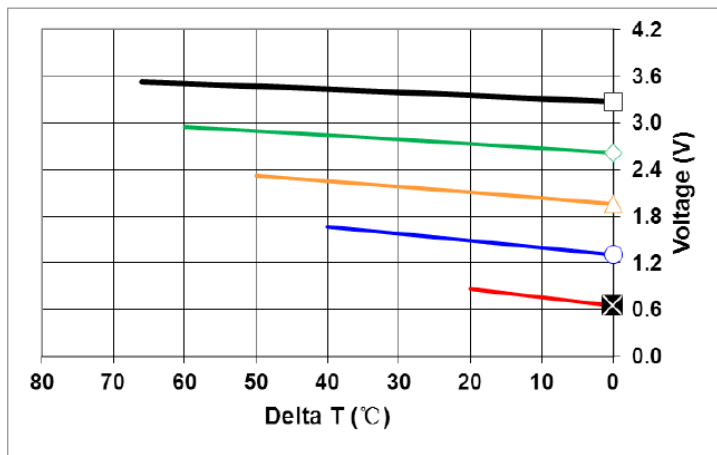

Mechanical Drawing:



Operation Tips:

- **Maximum Operating Temperature: 90°C**
- **Do not exceed I_{max} or V_{max} when operating module**
- **Please consult Wakefield-Vette for moisture and corrosion protection options as well as specific application inquiries**

Thermoelectric Cooler Performance Specifications



TEC-30-33-71

Hot Side Temperature(°C)	25 °C	50 °C
Qmax (Watts)	38.5	46
Delta Tmax(°C)	67	75
I _{max} (Amps)	8.5	8.5
V _{max} (Volts)	8.6	9.6
Module Resistance(Ohms)	0.86	0.97

**Tolerances for thermal and electrical parameters ± 10%.

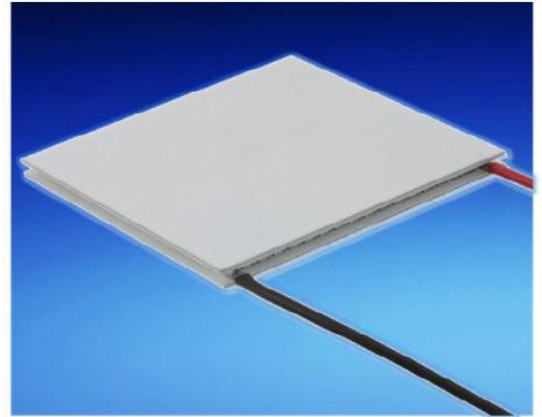

Performance Curves Th=25 °C

Performance Curves Th=50 °C

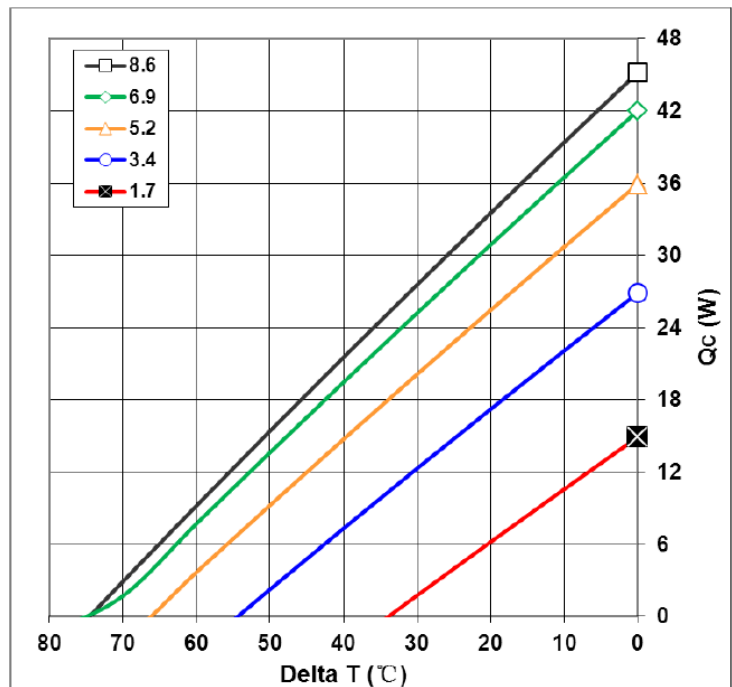
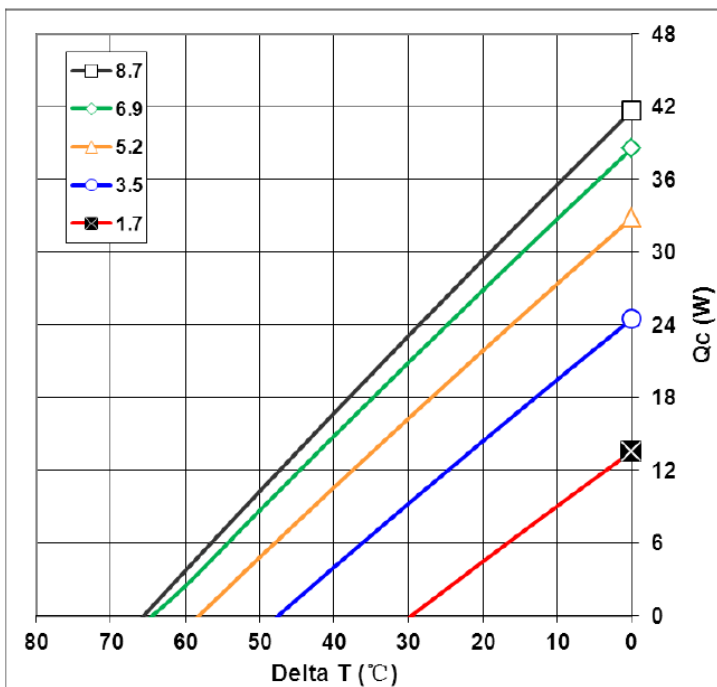
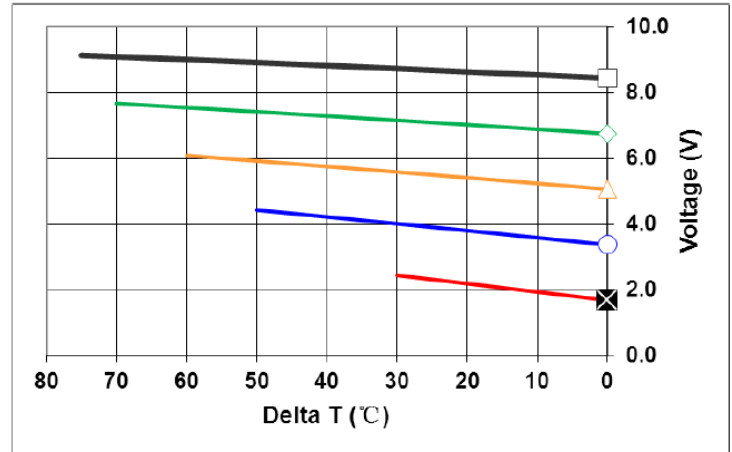

Mechanical Drawing:



Operation Tips:

- **Maximum Operating Temperature: 90°C**
- **Do not exceed I_{max} or V_{max} when operating module**
- **Please consult Wakefield-Vette for moisture and corrosion protection options as well as specific application inquiries**

Компания «Океан Электроники» предлагает заключение долгосрочных отношений при поставках импортных электронных компонентов на взаимовыгодных условиях!

Наши преимущества:

- Поставка оригинальных импортных электронных компонентов напрямую с производств Америки, Европы и Азии, а так же с крупнейших складов мира;
- Широкая линейка поставок активных и пассивных импортных электронных компонентов (более 30 млн. наименований);
- Поставка сложных, дефицитных, либо снятых с производства позиций;
- Оперативные сроки поставки под заказ (от 5 рабочих дней);
- Экспресс доставка в любую точку России;
- Помощь Конструкторского Отдела и консультации квалифицированных инженеров;
- Техническая поддержка проекта, помощь в подборе аналогов, поставка прототипов;
- Поставка электронных компонентов под контролем ВП;
- Система менеджмента качества сертифицирована по Международному стандарту ISO 9001;
- При необходимости вся продукция военного и аэрокосмического назначения проходит испытания и сертификацию в лаборатории (по согласованию с заказчиком);
- Поставка специализированных компонентов военного и аэрокосмического уровня качества (Xilinx, Altera, Analog Devices, Intersil, Interpoint, Microsemi, Actel, Aeroflex, Peregrine, VPT, Syfer, Eurofarad, Texas Instruments, MS Kennedy, Miteq, Cobham, E2V, MA-COM, Hittite, Mini-Circuits, General Dynamics и др.);

Компания «Океан Электроники» является официальным дистрибьютором и эксклюзивным представителем в России одного из крупнейших производителей разъемов военного и аэрокосмического назначения «JONHON», а так же официальным дистрибьютором и эксклюзивным представителем в России производителя высокотехнологичных и надежных решений для передачи СВЧ сигналов «FORSTAR».



JONHON

«JONHON» (основан в 1970 г.)

Разъемы специального, военного и аэрокосмического назначения:

(Применяются в военной, авиационной, аэрокосмической, морской, железнодорожной, горно- и нефтедобывающей отраслях промышленности)

«FORSTAR» (основан в 1998 г.)

ВЧ соединители, коаксиальные кабели, кабельные сборки и микроволновые компоненты:

(Применяются в телекоммуникациях гражданского и специального назначения, в средствах связи, РЛС, а так же военной, авиационной и аэрокосмической отраслях промышленности).



Телефон: 8 (812) 309-75-97 (многоканальный)

Факс: 8 (812) 320-03-32

Электронная почта: ocean@oceanchips.ru

Web: <http://oceanchips.ru/>

Адрес: 198099, г. Санкт-Петербург, ул. Калинина, д. 2, корп. 4, лит. А