



## Features

- RoHS compliant\*
- Conductive plastic or cermet
- Linear and audio tapers
- PC board and bushing mount
- Gangable
- Metal bushing and shaft
- Sealed for board washing



## 51/53 - Sealed 1/2" (12.5 mm) Square Control

| Electrical Characteristics <sup>1</sup>   | Conductive Plastic   | Cermet                |
|---|--|-----------------------|
| Standard Resistance Range   |  |                       |
| Linear .....  | 1 K ohms to 1 megohm.....  | 150 ohms to 1 megohm  |
| Audio .....   | 1 K ohms to 1 megohm.....  | 1 K ohms to 1 megohm  |
| Total Resistance Tolerance  |  |                       |
| Linear Tapers .....   | ±10 % or ±20 % .....   | ±10 % or ±5 %         |
| Audio Tapers .....  | ±10 % or ±20 % .....   | ±10 %                 |
| Independent Linearity .....   | ±5 % .....   | ±5 %                  |
| Absolute Minimum Resistance .....   | 2 ohms maximum .....   | 2 ohms maximum        |
| Effective Electrical Angle .....  | 270 ° ±5 ° .....   | 270 ° ±5 °            |
| Contact Resistance Variation .....  | 2 % .....  | 2 %                   |
| Dielectric Withstanding Voltage (MIL-STD-202 – Method 301)  |  |                       |
| Sea Level .....   | 1,500 VAC minimum .....  | 1,500 VAC minimum     |
| 70,000 .....  | 500 VAC minimum .....  | 500 VAC minimum       |
| Insulation Resistance .....   | 1,000 megohms minimum .....  | 1,000 megohms minimum |
| Power Rating At 70 °C (Derate To 0 At 125 °C)<br>(Voltage Limited By Power Dissipation or 350 VAC, Whichever Is Less) |  |                       |
| Linear Tapers .....   | 0.5 watt .....   | 1.0 watt              |
| Audio Tapers .....  | 0.25 watt .....  | 0.5 watt              |
| Theoretical Resolution .....  | Essentially infinite .....   | Essentially infinite  |
| <b>Environmental Characteristics<sup>1</sup></b>  |  |                       |
| Operating Temperature Range .....   | +1 °C to +125 °C .....   | +1 °C to +125 °C      |
| Storage Temperature Range .....   | -55 °C to +125 °C .....  | -55 °C to +125 °C     |
| Temperature Coefficient Over Storage Temperature Range .....  | ±1,000 ppm/°C .....  | ±150 ppm/°C           |
| Vibration (Single Section) .....  | 15 G .....   | 15 G                  |
| Total Resistance Shift .....  | ±2 % maximum .....   | ±2 % maximum          |
| Voltage Ratio Shift .....   | ±5 % maximum .....   | ±5 % maximum          |
| Shock (Single Section) .....  | 30 G .....   | 30 G                  |
| Total Resistance Shift .....  | +2 % maximum .....   | +2 % maximum          |
| Voltage Ratio Shift .....   | ±5 % maximum .....   | ±5 % maximum          |
| Load Life .....   | 1,000 hours .....  | 1,000 hours           |
| Total Resistance Shift .....  | ±10 % TRS maximum .....  | ±5 % TRS maximum      |
| Rotational Life (No Load) .....   | 50,000 cycles .....  | 25,000 cycles         |
| Total Resistance Shift .....  | ±10 % TRS maximum .....  | ±10 % TRS maximum     |
| Contact Resistance Variation @ 25,000 Cycles .....  | ±2 % .....   | ±4 %                  |
| Moisture Resistance (MIL-STD-202, Method 103, Condition B)  |  |                       |
| Total Resistance Shift .....  | ±10 % TRS .....  | ±5 % TRS              |
| IP Rating   |  |                       |
| Entire Unit .....   | IP64 .....   | IP64                  |
| Shaft/Bushing .....   | IP65 .....   | IP65                  |
| <b>Mechanical Characteristics</b>   |  |                       |
| Stop Strength .....   | 56 N-cm (5 lb.-in.)  |                       |
| Mechanical Angle .....  | 290 ° ±5 °   |                       |
| Torque  |  |                       |
| Starting (Dual Sections) .....  | +0.35 N-cm (+0.5 oz.-in.) maximum  |                       |
| Running (Single Section) .....  | 0.15 to 1.4 N-cm (0.2 to 2.0 oz.-in.)  |                       |
| Running (Dual Section) .....  | 0.35 to 1.8 N-cm (0.5 to 2.5 oz.-in.)  |                       |
| Detent (Single Section) .....   | 1.94 N-cm (2.75 oz.-in.) minimum   |                       |
| Mounting (Torque on Bushing) .....  | 1.7 to 2.0 N-m (15 to 18 lb.-in.) maximum  |                       |
| Weight (Single Section) .....   | 5.5 grams  |                       |
| (Additional Section) .....  | 3.0 grams  |                       |
| Terminals .....   | PC pin or solder lug   |                       |
| Soldering Condition .....   | Recommended hand soldering using Sn95/Ag5 no clean solder, 0.025" wire diameter.<br>Maximum temperature 399 °C (750 °F) for 3 seconds. No wash process to be used with no clean flux.<br>Part can be wave soldered at 260 °C (500 °F) for 5 seconds, no wash process with no clean flux. |                       |
| Marking .....   | Manufacturer's trademark, part number, resistance value and date code.   |                       |
| Ganging (Multiple Section Potentiometer) .....  | 2 sections maximum**   |                       |
| Hardware .....  | One lockwasher and one mounting nut is shipped with each potentiometer, except where noted in the part number.   |                       |

<sup>1</sup>At room ambient: +25 °C nominal and 50 % relative humidity nominal, except as noted.

\*\* Additional sections available on special request with higher minimum order quantities.

\*RoHS Directive 2002/95/EC Jan. 27, 2003 including annex and RoHS Recast 2011/65/EU June 8, 2011.

Specifications are subject to change without notice.

The device characteristics and parameters in this data sheet can and do vary in different applications and actual device performance may vary over time. Users should verify actual device performance in their specific applications.

# 51/53 - Sealed 1/2" (12.5 mm) Square Control

**BOURNS®**

## Product Dimensions

### PACKAGE DIMENSIONS

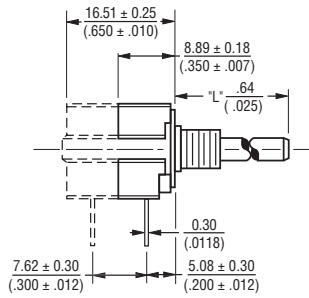

(SINGLE AND DUAL MODULE SHOWN)

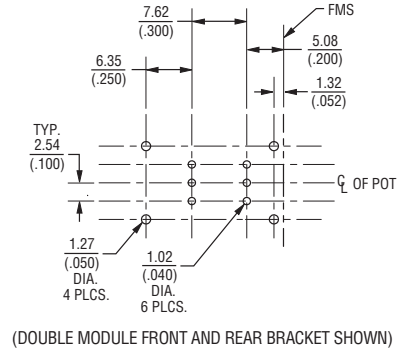
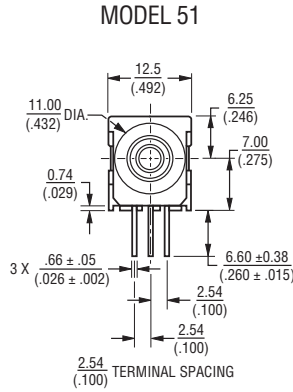

(DOUBLE MODULE FRONT AND REAR BRACKET SHOWN)

### PACKAGE DIMENSIONS PCB MOUNTING BRACKET

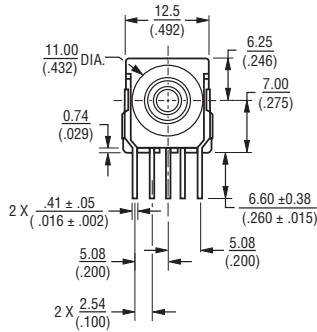
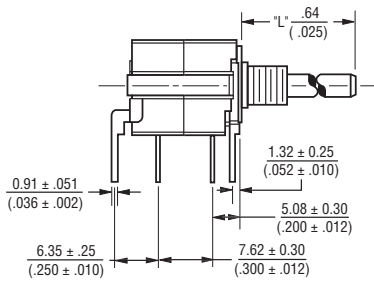

### SOLDER LUG TERMINALS MODEL 53

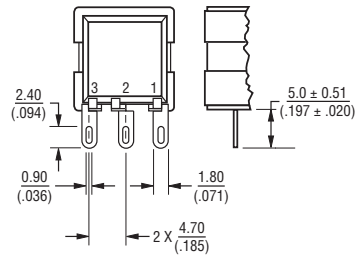

### ELECTRICAL SCHEMATIC



### ANTI-ROTATION LUG (Style "A" Shown)



### SHAFT FLAT ORIENTATION



### SUGGESTED PANEL LAYOUT



FOR TOLERANCES SHOWN: .XX = ± .25 (.010)  
 .XXX = ± .13 (.005)  
 SHAFT DIMENSIONS ± .80 (.132)

DIMENSIONS:  $\frac{\text{MM}}{\text{(INCHES)}}$

Specifications are subject to change without notice. The device characteristics and parameters in this data sheet can and do vary in different applications and actual device performance may vary over time. Users should verify actual device performance in their specific applications.

# 51/53 - Sealed 1/2" (12.5 mm) Square Control

# BOURNS®

## Shaft/Bushing Styles



**A Style Bushing**

| STD. LENGTH 'L' |
|-----------------|
| .500 (12.7)     |
| .625 (15.88)    |
| .750 (19.05)    |
| .875 (22.23)    |
| 1.000 (25.4)    |



**C Style Bushing**

| STD. LENGTH 'L' |
|-----------------|
| .375 (9.53)     |
| .500 (12.7)     |
| .625 (15.88)    |
| .750 (19.05)    |
| .875 (22.23)    |
| 1.000 (25.4)    |



**A Style Bushing - Flatted Shaft**

| STD. LENGTH 'L' |
|-----------------|
| .625 (15.88)    |
| .750 (19.05)    |
| .875 (22.23)    |
| 1.000 (25.4)    |



**S Style Bushing**

| STD. LENGTH 'L' |
|-----------------|
| .630 (16.0)     |
| .866 (22.0)     |
| .984 (25.0)     |



**U Style Bushing**

| STD. LENGTH 'L' |
|-----------------|
| .630 (16.0)     |
| .866 (22.0)     |
| .984 (25.0)     |



**R Style Bushing**

| STD. LENGTH 'L' |
|-----------------|
| .630 (16.0)     |
| .866 (22.0)     |
| .984 (25.0)     |

DIMENSIONS:  $\frac{\text{MM}}{\text{(INCHES)}}$

## How To Order

51 A A D - B 28 - A 15 / A15 L

Part number for multiple section potentiometers must have a taper and resistance value for each section.

RoHS IDENTIFIER  
L Compliant

**MOUNTING BRACKET/ ANTI-ROTATION LUG**

| Code | Description            |
|------|------------------------|
| A    | AR Lug 90° CW          |
| D    | No AR Lug or Bracket   |
| L    | Front Bracket          |
| M    | Rear Bracket           |
| N    | Front and Rear Bracket |

**# SECTIONS/DETENTS**

| Code | Description            |
|------|------------------------|
| A    | Single No Detent       |
| B    | Double No Detent       |
| E    | Single w/Center Detent |
| F    | Double w/Center Detent |

**BUSHING CONFIGURATION**

| Code | Description        |
|------|--------------------|
| A    | 3/8" D x 3/8" L    |
| C    | 1/4" D x 1/4" L    |
| R    | 10 mm D x 9.5 mm L |
| S    | 6 mm D x 8 mm L    |
| U    | 7 mm D x 8 mm L    |

**MODEL**

| Code | Description             |
|------|-------------------------|
| 51   | PC Pins (.100" centers) |
| 53   | Solder Lugs             |

| ELEMENT TAPER TYPE/TOLERANCE |                               | RESISTANCE (CODE) |              |
|------------------------------|-------------------------------|-------------------|--------------|
| Code                         | Description                   | VALUE IN OHMS     |              |
| (A)                          | Linear Cermet ±10 %           | (28) - 150        | (14) - 7.5 K |
| (H)                          | Linear Cermet ±5 %            | (06) - 200        | (15) - 10 K  |
|                              |                               | (07) - 250        | (30) - 15 K  |
|                              |                               | (08) - 500        | (16) - 20 K  |
|                              |                               | (09) - 750        | (17) - 25 K  |
|                              |                               | (10) - 1 K        | (18) - 50 K  |
|                              |                               | (29) - 1.5 K      | (19) - 75 K  |
|                              |                               | (11) - 2 K        | (20) - 100 K |
|                              |                               | (12) - 2.5 K      | (21) - 500 K |
|                              |                               | (13) - 5 K        | (25) - 1 M   |
| (B)                          | Linear C-P ±20 %              | (10) - 1 K        | (18) - 50 K  |
| (E)                          | Linear C-P ±10 %              | (12) - 2.5 K      | (20) - 100 K |
|                              |                               | (13) - 5 K        | (22) - 250 K |
|                              |                               | (15) - 10 K       | (23) - 500 K |
|                              |                               | (16) - 20 K       | (25) - 1 M   |
|                              |                               | (17) - 25 K       |              |
| (C)                          | CW Audio Cermet ±10 %         | (10) - 1 K        | (18) - 50 K  |
| (F)                          | CCW Audio Cermet ±10 %        | (12) - 2.5 K      | (20) - 100 K |
|                              |                               | (13) - 5 K        | (23) - 500 K |
|                              |                               | (15) - 10 K       | (25) - 1 M   |
|                              |                               | (17) - 25 K       |              |
| (D)                          | CW Audio C-P ±20 %            | (10) - 1 K        | (18) - 50 K  |
| (S)                          | CW Audio C-P ±10 %            | (12) - 2.5 K      | (20) - 100 K |
|                              |                               | (13) - 5 K        | (22) - 250 K |
|                              |                               | (15) - 10 K       | (23) - 500 K |
|                              |                               | (17) - 25 K       | (25) - 1 M   |
| (G)                          | CCW Audio C-P ±20 %           | (10) - 1 K        | (18) - 50 K  |
| (T)                          | CCW Audio C-P ±10 %           | (12) - 2.5 K      | (20) - 100 K |
|                              |                               | (13) - 5 K        | (22) - 250 K |
|                              |                               | (15) - 10 K       | (23) - 500 K |
|                              |                               | (17) - 25 K       | (25) - 1 M   |
| (Y)                          | CW Dual Audio Taper C-P ±20 % | (10) - 1 K        | (18) - 50 K  |
|                              |                               | (12) - 2.5 K      | (20) - 100 K |
|                              |                               | (13) - 5 K        | (22) - 250 K |
|                              |                               | (15) - 10 K       | (23) - 500 K |
|                              |                               | (17) - 25 K       | (25) - 1 M   |

| Code | SHAFT TYPE Description | AVAILABLE ONLY IN |                     |
|------|------------------------|-------------------|---------------------|
|      |                        | BUSHINGS Code     | LENGTHS Description |
| B    | Single Slotted 1/4" D  | A                 | 24,28               |
| C    | Single Flatted 1/4" D  | A                 | 20,24,28,32         |
| E    | Single Slotted 1/8" D  | C                 | 12,16,20,24,28      |
| R    | Single Slotted 6 mm D  | R                 | 16,22,25            |
| T    | Single Slotted 4 mm D  | U                 | 16,22,25            |
| U    | Single Slotted 3 mm D  | S                 | 16,22,25            |

| Code   | SHAFT LENGTH (FMS) Description | AVAILABLE ONLY IN BUSHING |             |
|--------|--------------------------------|---------------------------|-------------|
|        |                                | Code                      | Description |
| 12     | 3/8"                           | C                         |             |
| 16     | 1/2"                           | A, C                      |             |
| 20     | 5/8"                           | A, C                      |             |
| 24     | 3/4"                           | A, C                      |             |
| 28     | 7/8"                           | A, C                      |             |
| 32     | 1"                             | A, C                      |             |
| Metric |                                |                           |             |
| 16     | 16 mm                          | R, S, U                   |             |
| 22     | 22 mm                          | R, S, U                   |             |
| 25     | 25 mm                          | R, S, U                   |             |

Boldface features are Bourns standard options. All others are available with higher minimum order quantities.

Компания «Океан Электроники» предлагает заключение долгосрочных отношений при поставках импортных электронных компонентов на взаимовыгодных условиях!

Наши преимущества:

- Поставка оригинальных импортных электронных компонентов напрямую с производств Америки, Европы и Азии, а так же с крупнейших складов мира;
- Широкая линейка поставок активных и пассивных импортных электронных компонентов (более 30 млн. наименований);
- Поставка сложных, дефицитных, либо снятых с производства позиций;
- Оперативные сроки поставки под заказ (от 5 рабочих дней);
- Экспресс доставка в любую точку России;
- Помощь Конструкторского Отдела и консультации квалифицированных инженеров;
- Техническая поддержка проекта, помощь в подборе аналогов, поставка прототипов;
- Поставка электронных компонентов под контролем ВП;
- Система менеджмента качества сертифицирована по Международному стандарту ISO 9001;
- При необходимости вся продукция военного и аэрокосмического назначения проходит испытания и сертификацию в лаборатории (по согласованию с заказчиком);
- Поставка специализированных компонентов военного и аэрокосмического уровня качества (Xilinx, Altera, Analog Devices, Intersil, Interpoint, Microsemi, Actel, Aeroflex, Peregrine, VPT, Syfer, Eurofarad, Texas Instruments, MS Kennedy, Miteq, Cobham, E2V, MA-COM, Hittite, Mini-Circuits, General Dynamics и др.);

Компания «Океан Электроники» является официальным дистрибьютором и эксклюзивным представителем в России одного из крупнейших производителей разъемов военного и аэрокосмического назначения «JONHON», а так же официальным дистрибьютором и эксклюзивным представителем в России производителя высокотехнологичных и надежных решений для передачи СВЧ сигналов «FORSTAR».



## JONHON

«JONHON» (основан в 1970 г.)

Разъемы специального, военного и аэрокосмического назначения:

(Применяются в военной, авиационной, аэрокосмической, морской, железнодорожной, горно- и нефтедобывающей отраслях промышленности)

«FORSTAR» (основан в 1998 г.)

ВЧ соединители, коаксиальные кабели,  
кабельные сборки и микроволновые компоненты:

(Применяются в телекоммуникациях гражданского и специального назначения, в средствах связи, РЛС, а так же военной, авиационной и аэрокосмической отраслях промышленности).



Телефон: 8 (812) 309-75-97 (многоканальный)

Факс: 8 (812) 320-03-32

Электронная почта: [ocean@oceanchips.ru](mailto:ocean@oceanchips.ru)

Web: <http://oceanchips.ru/>

Адрес: 198099, г. Санкт-Петербург, ул. Калинина, д. 2, корп. 4, лит. А