

PRODUCT NUMBER
10106814-0XX0X2LF



10106814-0XX0X2LF
HERMAPHRODITIC CONNECTOR
ASSEMBLY



PRINTED
CIRCUIT
BOARD

CONNECTOR ORIENTATION
FEATURE
SEE PCB LAYOUT ON PAGE 5

10106814-0XX0X2LF
HERMAPHRODITIC CONNECTOR
ASSEMBLY

CONNECTOR ORIENTATION
FEATURE
SEE PCB LAYOUT ON PAGE 5

Copyright FCI.
FCI

spec ref	---	dr	Stu Stoner	2010/1/22	projection	mm	size	A2	scale	20:1
tolerance std	ASME Y14.5	eng	Andy Lu	2015/07/15		mm	ecn no	ELX-DG-21387-1		
TOLERANCES UNLESS OTHERWISE SPECIFIED		chr	-	rel level				Released		
surface	✓	appr	Pei-Ming Zheng	2015/07/15	product family	MezzoStack	rel level	Released	cat. no.	10106814
ASME Y14.5	linear	0.X	±0.3		title HERMAPHRODITIC CONNECTOR, SHORT STYLE 20-90 POS, 0.5MM CTR, 4-7MM STACK HT	dwg no 10106814	rev D	Product - Customer Drw		
	0.XX	±0.15	sheet 1 of 8							
	0.XXX	±0.05								
	angular	0°	±3°	www.fci.com	cat. no.	-	Product - Customer Drw			

PDS: Rev :D

STATUS:Released

Printed: Jul 16, 2015



CONNECTOR ORIENTATION FEATURE

POSITION 1
SEE CONNECTOR MATING TABLE

POSITION 3

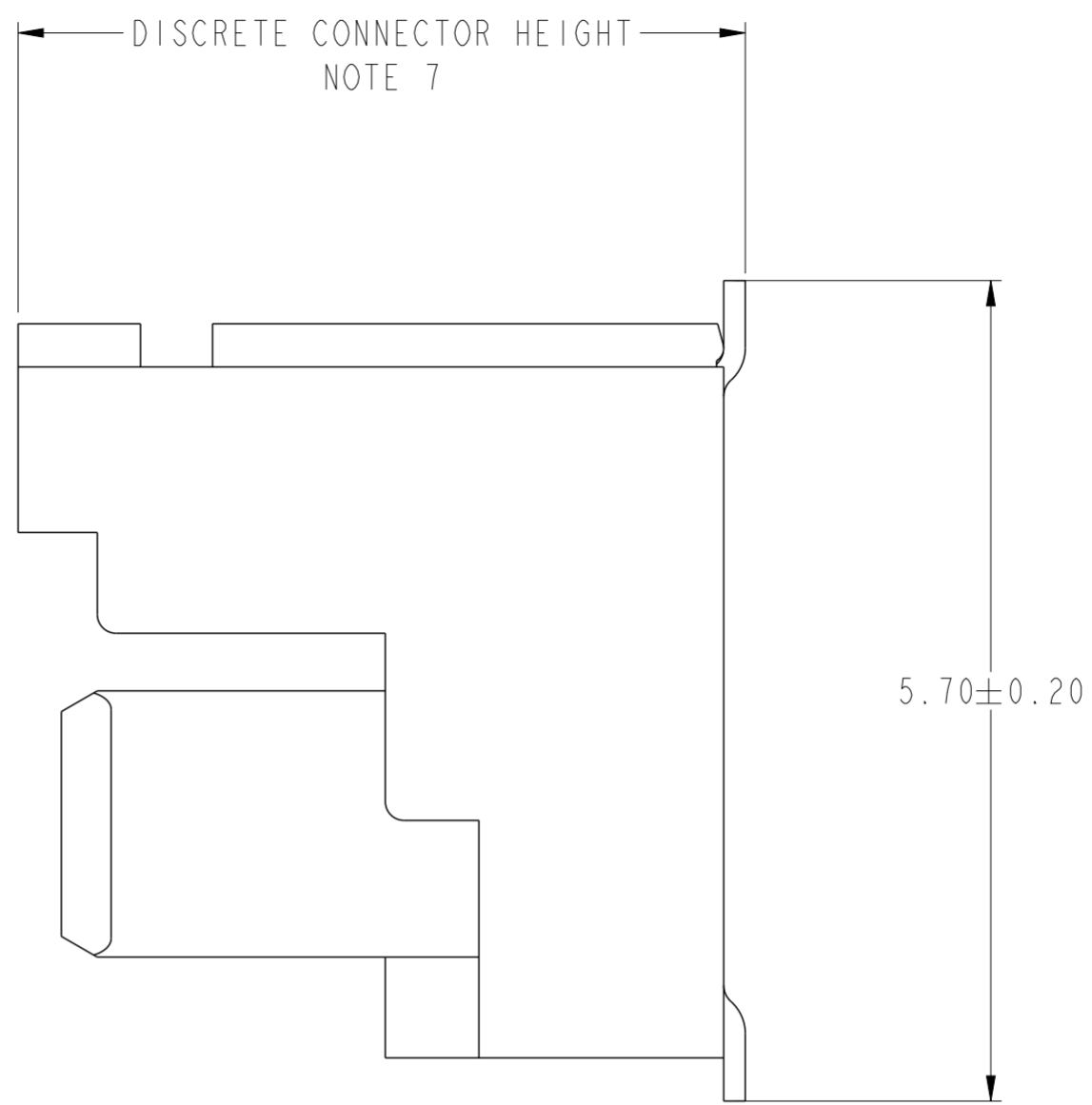
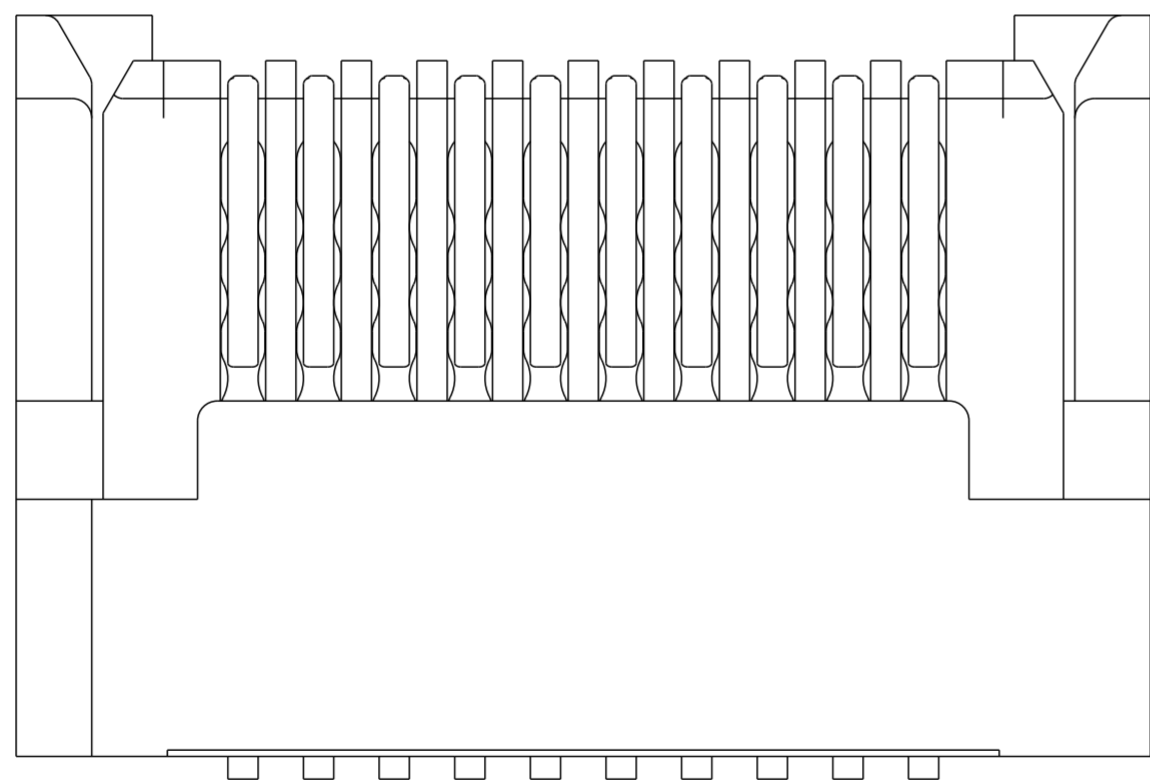

HERMAPHRODITIC CONNECTOR MATING	
CONNECTOR POSITION	MATES WITH CONNECTOR POSITION
1	2
3	4
5	6
7	8
9	10
ETC.	

10106814-024002LF SHOWN
WITHOUT STANDARD PICK-UP CAP

Copyright FCI.
FCI

spec ref	---	dr	Stu Stoner	2010/11/22	projection	mm	size	A2	scale	20:1			
tolerance std	ASME Y14.5	eng	Andy Lu	2015/07/15			ecn no	ELX-DG-21387-1					
TOLERANCES UNLESS OTHERWISE SPECIFIED		chr	-	appr			Pei-Ming Zheng	2015/07/15	product family	MezzoStack			
surface	✓	linear	0.X	±0.3		title HERMAPHRODITIC CONNECTOR, SHORT STYLE 20-90 POS, 0.5MM CTR, 4-7MM STACK HT	rev no 10106814	rev D	rel level		Released		
		linear	0.XX	±0.15					cat. no.	Product - Customer Drw		sheet 2 of 8	
		angular	0°	±3°									

PDS: Rev :D

STATUS:Released

Printed: Jul 16, 2015

0.5 BTB HERMAPHRODITIC CONNECTOR ASSEMBLY PART NUMBER SCHEME
EXAMPLE: 10106814-XX X X X 2 LF

NUMBER OF POSITIONS
02 = 20 POS
03 = 30 POS
04 = 40 POS
05 = 50 POS
06 = 60 POS
07 = 70 POS
08 = 80 POS
09 = 90 POS

PRACTICAL CONNECTOR HEIGHT NOTE 8
1 = 2.0MM
2 = 2.5MM
3 = 3.0MM
4 = 3.5MM

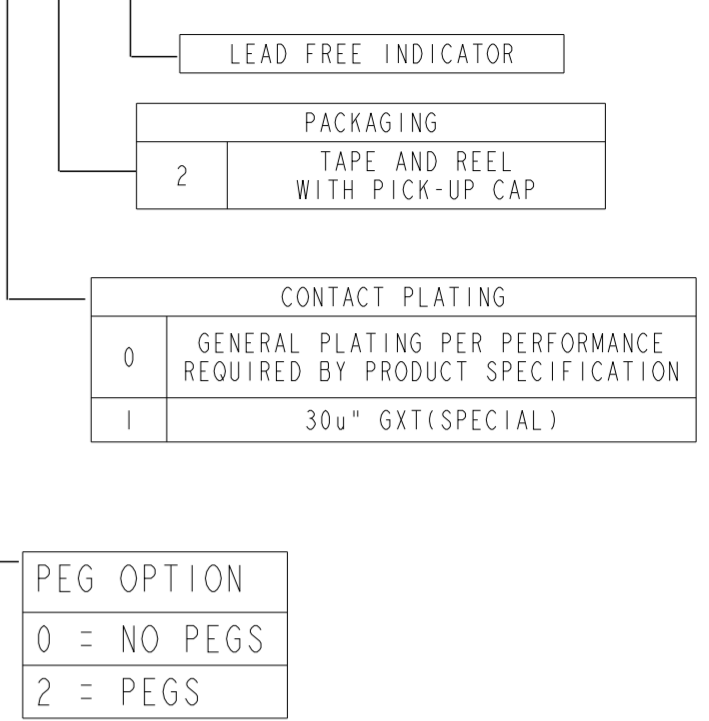

PRODUCT NUMBER	NUMBER OF POSITIONS	DIM A	DIM B	DISCRETE CONNECTOR HEIGHT NOTE 9	PRACTICAL CONNECTOR HEIGHT NOTE 8	STATUS
10106814-021002LF	20	7.5	4.5	3.55	2.00	RELEASED
10106814-031002LF	30	10.0	7.0			
10106814-041002LF	40	12.5	9.5			
10106814-051002LF	50	15.0	12.0			
10106814-061002LF	60	17.5	14.5			
10106814-071002LF	70	20.0	17.0	4.05	2.50	UN-RELEASED
10106814-022002LF	20	7.5	4.5			
10106814-032002LF	30	10.0	7.0			
10106814-042002LF	40	12.5	9.5			
10106814-052002LF	50	15.0	12.0			
10106814-062002LF	60	17.5	14.5	4.55	3.00	RELEASED
10106814-072002LF	70	20.0	17.0			
10106814-023002LF	20	7.5	4.5			
10106814-033002LF	30	10.0	7.0			
10106814-043002LF	40	12.5	9.5			
10106814-053002LF	50	15.0	12.0	5.05	3.50	RELEASED
10106814-063002LF	60	17.5	14.5			
10106814-073002LF	70	20.0	17.0			
10106814-083002LF	80	22.5	19.5			
10106814-093002LF	90	25.0	22.0			
10106814-024002LF	20	7.5	4.5	5.05	3.50	RELEASED
10106814-034002LF	30	10.0	7.0			
10106814-044002LF	40	12.5	9.5			
10106814-054002LF	50	15.0	12.0			
10106814-064002LF	60	17.5	14.5			
10106814-074002LF	70	20.0	17.0			

spec ref	---	dr	Stu Stoner	2010/1/22	projection	mm	size	A2	scale	10:1
tolerance std	ASME Y14.5	eng	Andy Lu	2015/07/15	chr	-	ecn no	ELX-DG-21387-1	rel level	Released
surface	✓	appr	Pei-Ming Zheng	2015/07/15	product family	MezzoStak	rel level	Released	title	HERMAPHRODITIC CONNECTOR, SHORT STYLE
ASME Y14.5	linear	0.X	±0.3	0.XX	±0.15	0.XXX	±0.05	angular	0°	±3°
		www.fci.com		cat. no.	-		Product - Customer Drw	sheet 3 of 8	rev	D

PDS: Rev :D

STATUS:Released

Printed: Jul 16, 2015

Copyright FCI. FCI



10106814-024002LF SHOWN
WITH STANDARD PICK-UP CAP

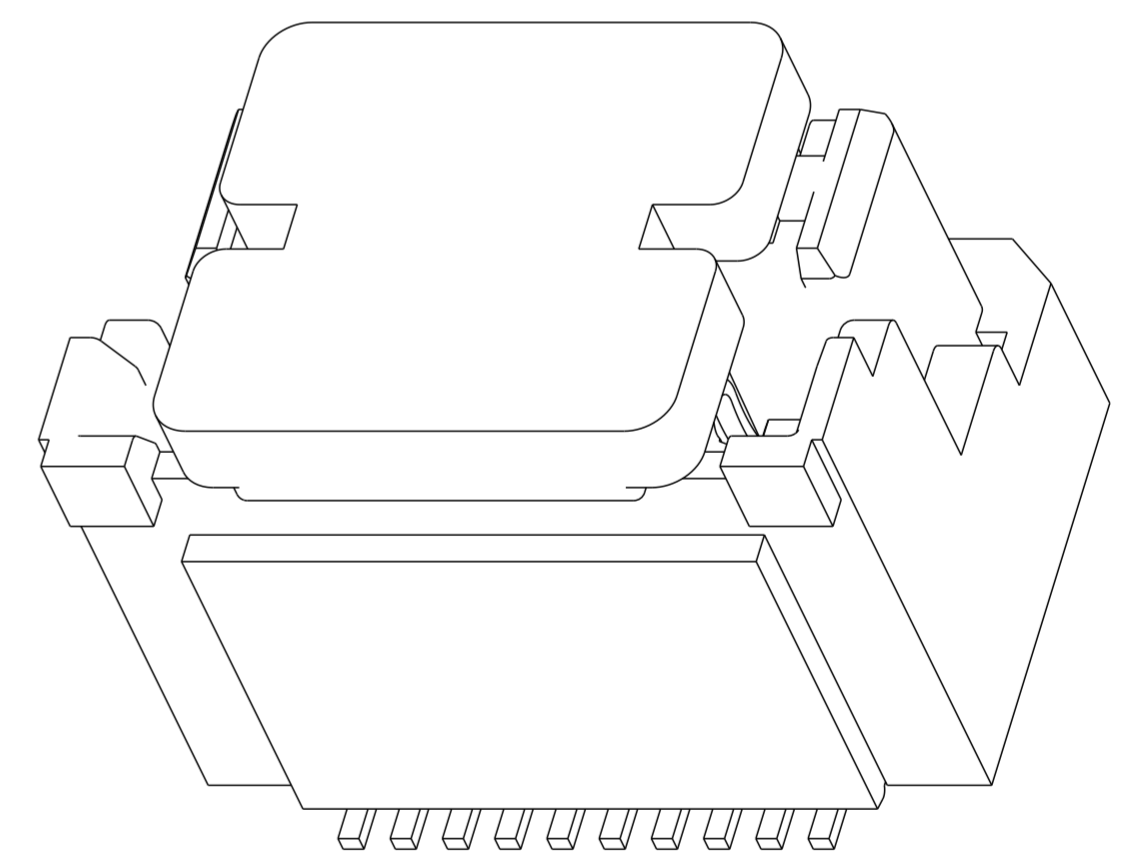
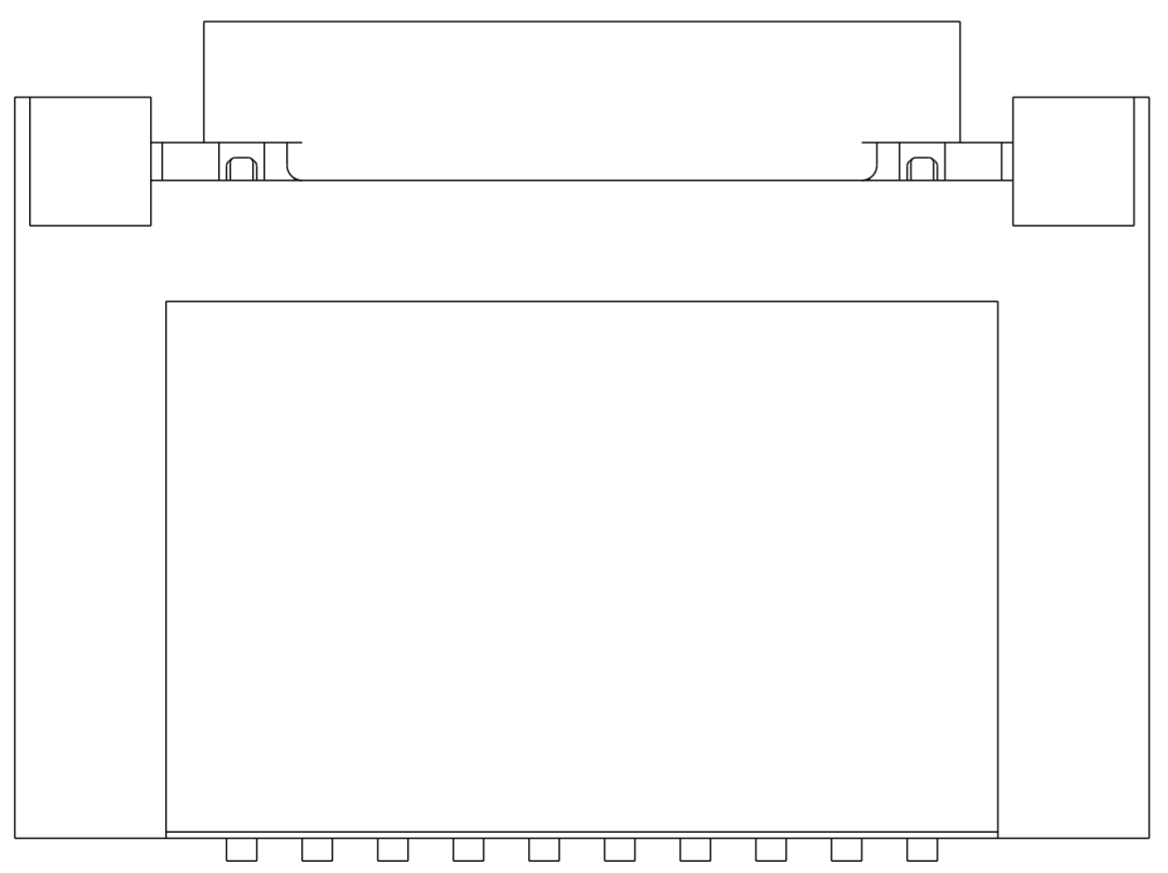

Copyright FCI.
FCI

spec ref	---	dr	Stu Stoner	2010/1/22	projection	mm	size	A2	scale	20:1
tolerance std	ASME Y14.5	eng	Andy Lu	2015/07/15			ecn no	ELX-DG-21387-1		
TOLERANCES UNLESS OTHERWISE SPECIFIED		chr	-	appr			Pei-Ming Zheng	2015/07/15	product family	MezzoStak
surface		linear	0.X	±0.3		title HERMAPHRODITIC CONNECTOR, SHORT STYLE 20-90 POS, 0.5MM CTR, 4-7MM STACK HT	dwg no 10106814	rev D		
			0.XX	±0.15						
			0.XXX	±0.05						
ASME Y14.5	angular	0°	±3°	www.fci.com	cat. no.	-	Product - Customer Drw	sheet 4 of 8		

PRODUCT NUMBER	NUMBER OF POSITIONS	DIM A	DIM B	DIM C	PEGS STATUS	DIM_D
10106814-02X002LF	20	2.25	4.50	7.50	NO	N/A
10106814-03X002LF	30	3.50	7.00	10.00	NO	N/A
10106814-04X002LF	40	4.75	9.50	12.50	NO	N/A
10106814-05X002LF	50	6.00	12.00	15.00	NO	N/A
10106814-06X002LF	60	7.25	14.50	17.50	NO	N/A
10106814-07X002LF	70	8.50	17.00	20.00	NO	N/A
10106814-08X002LF	80	9.75	19.50	22.50	NO	N/A
10106814-09X0X2LF	90	11.00	22.00	25.00	NO	N/A
10106814-08X202LF	80	9.75	19.50	22.50	YES	22.00
10106814-09X202LF	90	11.00	22.00	25.00	YES	24.50

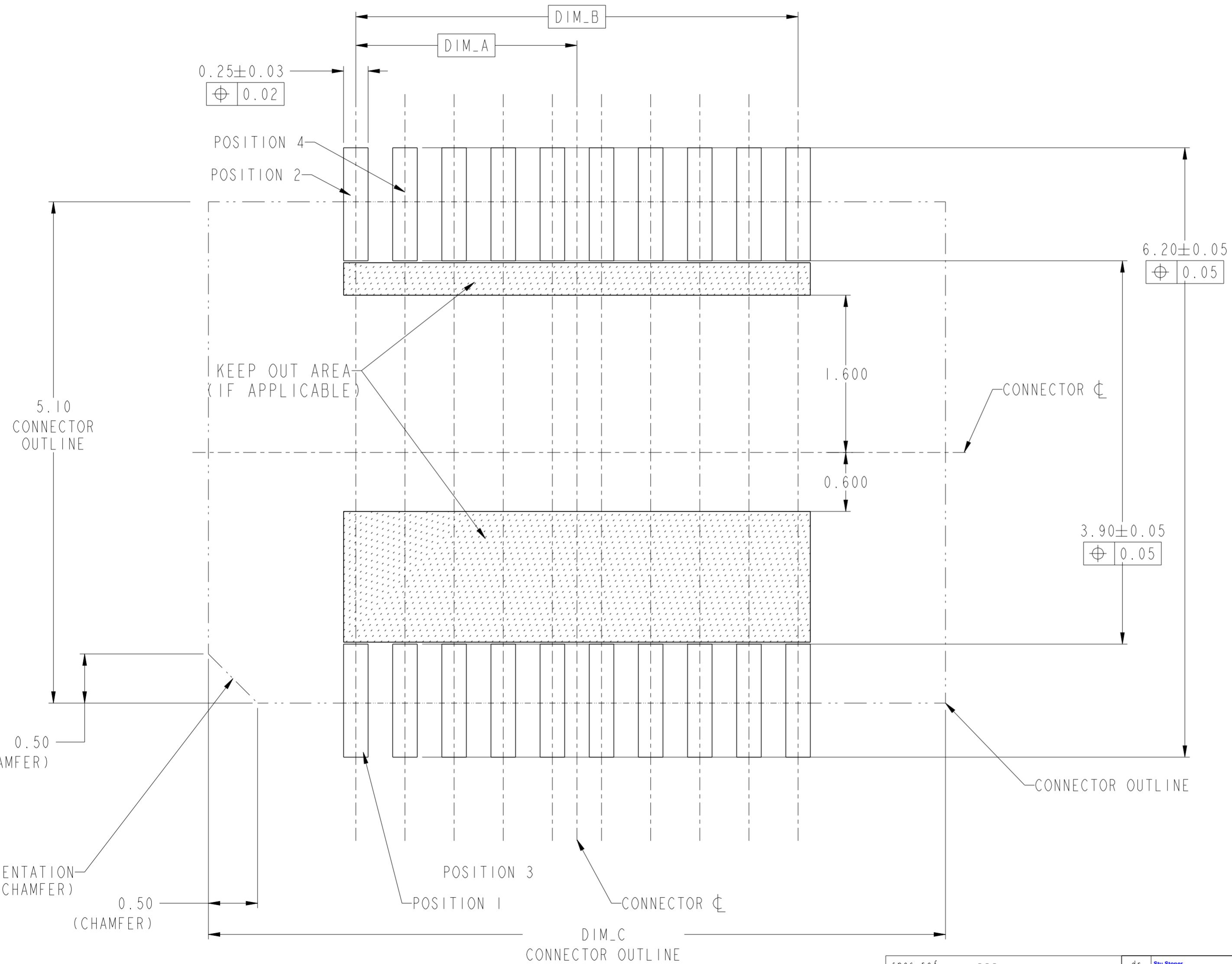

OPTION 1 - SPACE OPTIMIZED FOOTPRINT
SEE TABLE FOR CONNECTOR LAYOUT DIMENSIONS
SEE NOTE 8 FOR STENCIL CREATION GUIDELINES

spec ref	---	dr	Stu Stoner	2010/1/22	projection	mm	size	A2	scale	30:1	
tolerance std	ASME Y14.5	eng	Andy Lu	2015/07/15	chr	-	ecn no	ELX-DG-21387-1	rel level	Released	
surface	✓	appr	Pei-Ming Zheng	2015/07/15	product family	MezzoStak	rel level	Released	title	HERMAPHRODITIC CONNECTOR, SHORT STYLE	
ASME Y14.5	linear	0.X	±0.3	0.XX	±0.15	0.XXX	±0.05	angular	0°	±3°	
		www.fci.com		cat. no.		Product - Customer Drw		sheet 5 of 8		rev	D



PRODUCT NUMBER	NUMBER OF POSITIONS	DIM A	DIM B	DIM C	PEGS STATUS	DIM_D
10106814-02X002LF	20	2.25	4.50	7.50	NO	N/A
10106814-03X002LF	30	3.50	7.00	10.00	NO	N/A
10106814-04X002LF	40	4.75	9.50	12.50	NO	N/A
10106814-05X002LF	50	6.00	12.00	15.00	NO	N/A
10106814-06X002LF	60	7.25	14.50	17.50	NO	N/A
10106814-07X002LF	70	8.50	17.00	20.00	NO	N/A
10106814-08X002LF	80	9.75	19.50	22.50	NO	N/A
10106814-09X0X2LF	90	11.00	22.00	25.00	NO	N/A
10106814-08X202LF	80	9.75	19.50	22.50	YES	22.00
10106814-09X202LF	90	11.00	22.00	25.00	YES	24.50

A
B
C
D
E
F

A
B
C
D
E
F

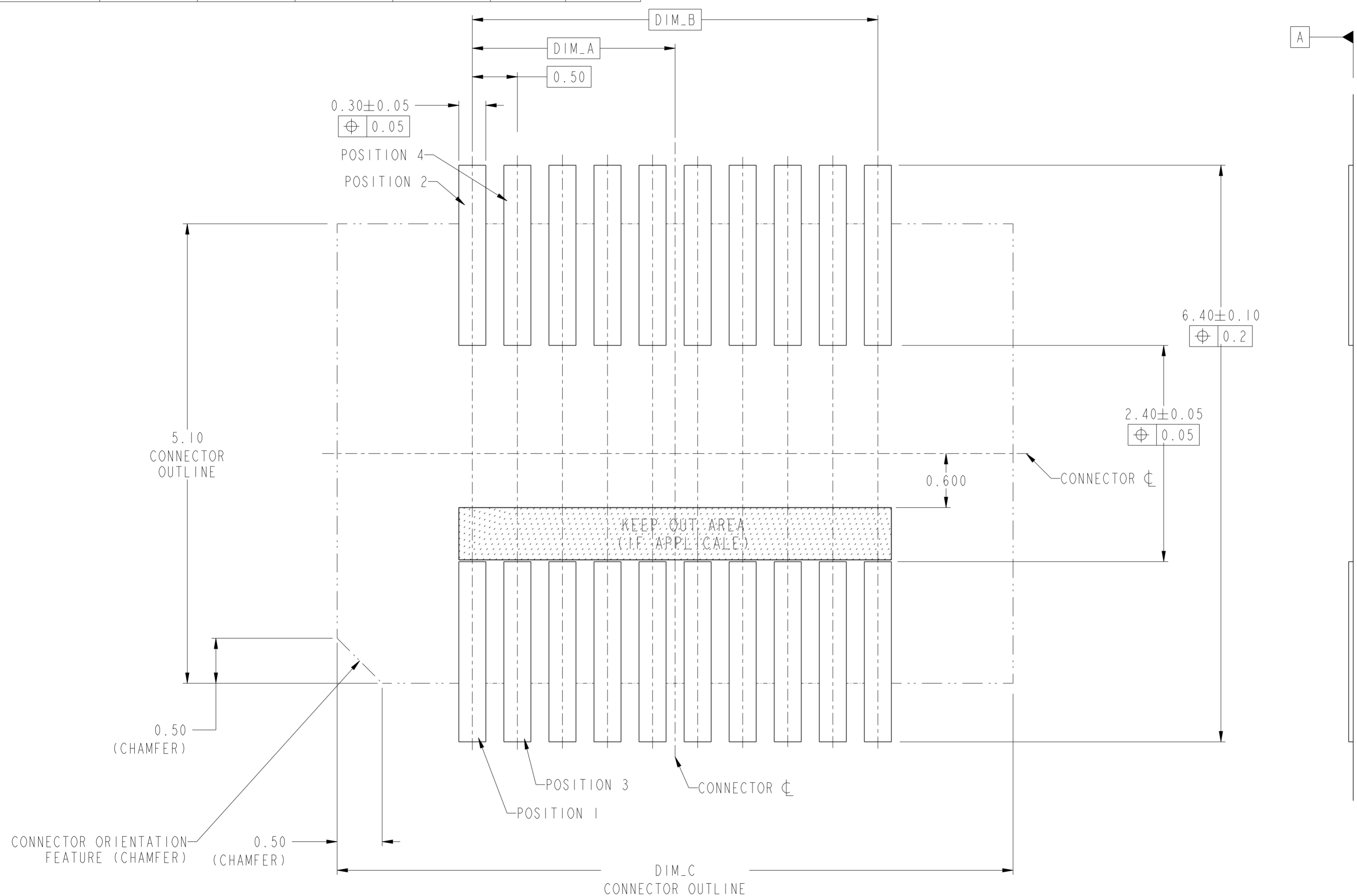

OPTION 2 - FOOTPRINT
SEE TABLE FOR CONNECTOR LAYOUT DIMENSIONS
SEE NOTE 8 FOR STENCIL CREATION GUIDELINES

spec ref	---	dr	Stu Stoner	2010/1/22	projection	mm	size	A2	scale	10:1
tolerance std	ASME Y14.5	eng	Andy Lu	2015/07/15	chr	-	ecn no	ELX-DG-21387-1	rel level	Released
surface	linear	appr	Pei-Ming Zheng	2015/07/15	product family	MezzoStack	divg no	10106814	rev	D
ASME Y14.5	angular	www.fci.com	cat. no.	-	Product - Customer Drw	sheet 6 of 8				

Copyright FCI. FCI

10106814-0932X2LF SHOWN



SCALE 15:1

2X (Ø0.50) PEGS FEATURE
ONLY FOR 10106814-083202LF
AND 10106814-093202LF

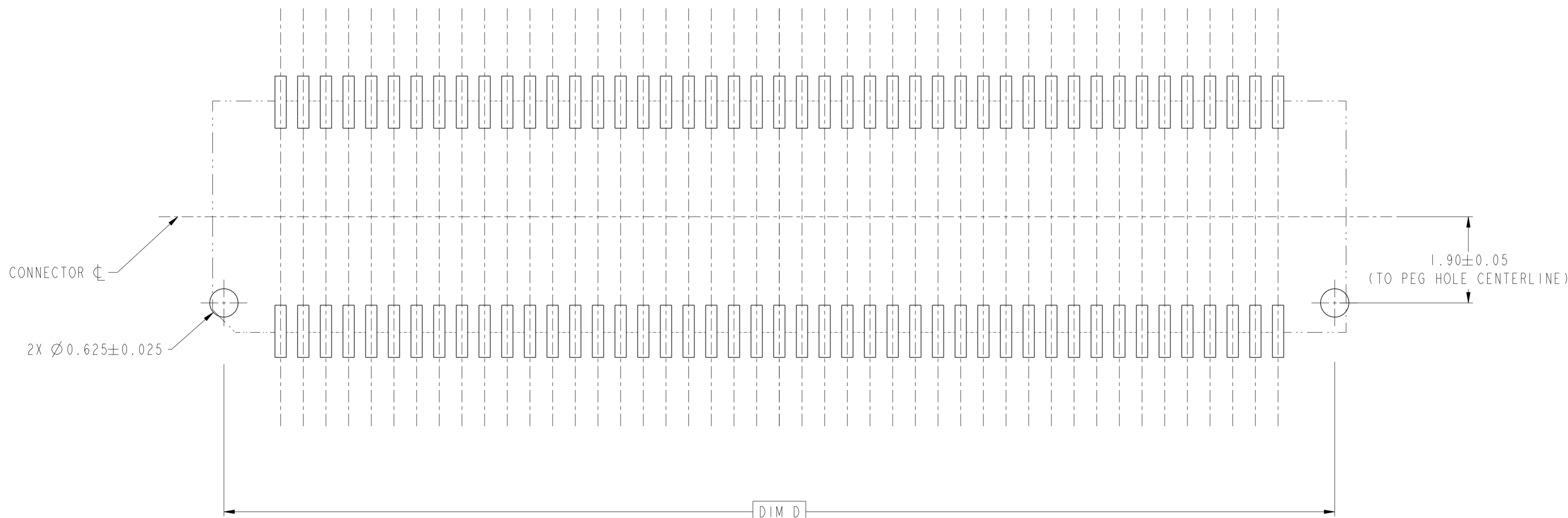

PCB LAYOUT FOR 10106814-083202LF AND 10106814-093202LF
OTHER DIMENSIONS, SEE SHEET 5 AND 6

SCALE 15:1

spec ref	---	dr	Stu Stoner	2010/11/22	projection	mm	size	A2	scale	10:1		
tolerance std	ASME Y14.5	eng	Andy Lu	2015/07/15		mm	ecn no	ELX-DG-21387-1	rel level	Released		
TOLERANCES UNLESS OTHERWISE SPECIFIED		chr	-	appr							Pei-Ming Zheng	2015/07/15
surface	✓	linear	0.X	±0.3		title HERMAPHRODITIC CONNECTOR, SHORT STYLE 20-90 POS, 0.5MM CTR, 4-7MM STACK HT	dwg no 10106814	rev D	Product - Customer Drw			
		angular	0°	±3°					www.fci.com	cat. no.	Product - Customer Drw	sheet 7 of 8

PDS: Rev :D

STATUS: Released





Printed: Jul 16, 2015

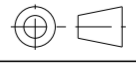

Copyright FCI.

NOTES

- 1 - MATERIAL:
HOUSING - HIGH-TEMPERATURE THERMOPLASTIC, UL94-V0, COLOR: BLACK
CONTACTS: COPPER ALLOY
CONTACT PLATING:
SEPARABLE INTERFACE: PERFORMANCE-BASED PLATING, QUALIFIED TO MEET THE REQUIREMENTS OF FCI PRODUCT SPECIFICATION.
SOLDER TAILS: GOLD FLASH.
- 2 - RECOMMENDED LEAD FREE SOLDER PASTE THICKNESS 150µm.
- 3 - THE HOUSING WILL WITHSTAND EXPOSURE TO 260°C PEAK TEMPERATURE FOR 30 SECONDS IN A CONVECTION INFRA RED OR VAPOR PHASE REFLOW OVEN.
- 4 - THIS PRODUCT MEETS EUROPEAN UNION DIRECTIVES AND OTHER COUNTRY REGULATION AS DESCRIBED IN GS-22-008
- 5 - PACKAGING TAPE AND REEL. PACKAGING SPECIFICATION GS-14-1320, PRODUCT SPECIFICATION GS-12-1322.
- 6 - PRACTICAL CONNECTOR HEIGHT AS SPECIFIED IN THE TABLE IS NOT THE DIMENSIONAL HEIGHT OF THE CONNECTOR BUT THE HEIGHT AS IT PERTAINS TO TOTAL STACK HEIGHT. AN EXAMPLE IS A CONNECTOR WITH A 2.5MM PRACTICAL CONNECTOR HEIGHT, WHEN MATED TO ITSELF WILL RESULTING IN A BOARD TO BOARD STACK HEIGHT OF 5MM.
- 7 - DISCRETE CONNECTOR HEIGHT AS SHOWN IN THE TABLE IS THE ACTUAL DIMENSIONAL CONNECTOR HEIGHT. ALSO SEE INFORMATION ON PRACTICAL HEIGHT IN NOTE 6.
- 8 - REFER TO IPC 7525-A FOR STENCIL CREATION.

spec ref	---	dr	Stu Stoner	2010/1/22	projection	mm	size	A2	scale	20:1	
tolerance std	ASME Y14.5	eng	Andy Lu	2015/07/15			ecn no	ELX-DG-21387-1			
TOLERANCES UNLESS OTHERWISE SPECIFIED		chr	-	appr			Pei-Ming Zheng	2015/07/15	product family	MezzoStak	rel level
surface		linear	0.X	±0.3		title HERMAPHRODITIC CONNECTOR, SHORT STYLE 20-90 POS, 0.5MM CTR, 4-7MM STACK HT	dwg no 10106814	rev D			
			0.XX	±0.15							
			0.XXX	±0.05							
ASME Y14.5		angular	0°	±3°	www.fci.com	cat. no.	-	Product - Customer Drw	sheet 8 of 8		

Copyright FCI. FCI

Компания «Океан Электроники» предлагает заключение долгосрочных отношений при поставках импортных электронных компонентов на взаимовыгодных условиях!

Наши преимущества:

- Поставка оригинальных импортных электронных компонентов напрямую с производств Америки, Европы и Азии, а так же с крупнейших складов мира;
- Широкая линейка поставок активных и пассивных импортных электронных компонентов (более 30 млн. наименований);
- Поставка сложных, дефицитных, либо снятых с производства позиций;
- Оперативные сроки поставки под заказ (от 5 рабочих дней);
- Экспресс доставка в любую точку России;
- Помощь Конструкторского Отдела и консультации квалифицированных инженеров;
- Техническая поддержка проекта, помощь в подборе аналогов, поставка прототипов;
- Поставка электронных компонентов под контролем ВП;
- Система менеджмента качества сертифицирована по Международному стандарту ISO 9001;
- При необходимости вся продукция военного и аэрокосмического назначения проходит испытания и сертификацию в лаборатории (по согласованию с заказчиком);
- Поставка специализированных компонентов военного и аэрокосмического уровня качества (Xilinx, Altera, Analog Devices, Intersil, Interpoint, Microsemi, Actel, Aeroflex, Peregrine, VPT, Syfer, Eurofarad, Texas Instruments, MS Kennedy, Miteq, Cobham, E2V, MA-COM, Hittite, Mini-Circuits, General Dynamics и др.);

Компания «Океан Электроники» является официальным дистрибьютором и эксклюзивным представителем в России одного из крупнейших производителей разъемов военного и аэрокосмического назначения «JONHON», а так же официальным дистрибьютором и эксклюзивным представителем в России производителя высокотехнологичных и надежных решений для передачи СВЧ сигналов «FORSTAR».



JONHON

«JONHON» (основан в 1970 г.)

Разъемы специального, военного и аэрокосмического назначения:

(Применяются в военной, авиационной, аэрокосмической, морской, железнодорожной, горно- и нефтедобывающей отраслях промышленности)

«FORSTAR» (основан в 1998 г.)

ВЧ соединители, коаксиальные кабели, кабельные сборки и микроволновые компоненты:

(Применяются в телекоммуникациях гражданского и специального назначения, в средствах связи, РЛС, а так же военной, авиационной и аэрокосмической отраслях промышленности).



Телефон: 8 (812) 309-75-97 (многоканальный)

Факс: 8 (812) 320-03-32

Электронная почта: ocean@oceanchips.ru

Web: <http://oceanchips.ru/>

Адрес: 198099, г. Санкт-Петербург, ул. Калинина, д. 2, корп. 4, лит. А