

FEATURES

- Easy to use
- Low cost solution
- Higher performance than two or three op amp design
- Unity gain with no external resistor
- Optional gains with one external resistor
(Gain range: 2 to 1000)
- Wide power supply range: $\pm 2.6\text{ V}$ to $\pm 15\text{ V}$
- Available in 8-lead PDIP and 8-lead SOIC_N packages
- Low power, 1.5 mA maximum supply current
- DC performance
 - 0.15% gain accuracy: $G = 1$
 - 125 μV maximum input offset voltage
 - 1.0 $\mu\text{V}/^\circ\text{C}$ maximum input offset drift
 - 5 nA maximum input bias current
 - 66 dB minimum common-mode rejection ratio: $G = 1$
- Noise
 - 12 nV/ $\sqrt{\text{Hz}}$ @ 1 kHz input voltage noise
 - 0.60 μV p-p noise: 0.1 Hz to 10 Hz, $G = 10$
- AC characteristics
 - 800 kHz bandwidth: $G = 10$
 - 10 μs settling time to 0.1% @ $G = 1$ to 100
 - 1.2 V/ μs slew rate

APPLICATIONS

- Transducer interface
- Low cost thermocouple amplifier
- Industrial process controls
- Difference amplifier
- Low cost data acquisition

PIN CONFIGURATION



Figure 1. 8-Lead PDIP and 8-Lead SOIC_N
(N and R Suffixes)

GENERAL DESCRIPTION

The AD622 is a low cost, moderately accurate instrumentation amplifier in the traditional pin configuration that requires only one external resistor to set any gain between 2 and 1000. For a gain of 1, no external resistor is required. The AD622 is a complete difference or subtractor amplifier system that also provides superior linearity and common-mode rejection by incorporating precision laser-trimmed resistors.

The AD622 replaces low cost, discrete, two or three op amp instrumentation amplifier designs and offers good common-mode rejection, superior linearity, temperature stability, reliability, power, and board area consumption. The low cost of the AD622 eliminates the need to design discrete instrumentation amplifiers to meet stringent cost targets. While providing a lower cost solution, it also provides performance and space improvements.

Table 1. Next Generation Upgrades for AD622

Part	Comment
AD8221	Better specs at lower price
AD8222	Dual channel or differential out
AD8226	Low power, wide input range
AD8220	JFET input
AD8228	Best gain accuracy
AD8295	+2 precision op amps or differential out
AD8421	Low noise, better specs

Rev. E

Information furnished by Analog Devices is believed to be accurate and reliable. However, no responsibility is assumed by Analog Devices for its use, nor for any infringements of patents or other rights of third parties that may result from its use. Specifications subject to change without notice. No license is granted by implication or otherwise under any patent or patent rights of Analog Devices. Trademarks and registered trademarks are the property of their respective owners.

TABLE OF CONTENTS

Features	1	Theory of Operation	9
Applications.....	1	Make vs. Buy: A Typical Application Error Budget.....	9
Pin Configuration.....	1	Gain Selection	11
General Description	1	Input and Output Offset Voltage.....	11
Revision History	2	Reference Terminal	11
Specifications.....	3	Input Protection	11
Absolute Maximum Ratings.....	5	RF Interference	12
Thermal Resistance	5	Ground Returns for Input Bias Currents	12
ESD Caution.....	5	Outline Dimensions	13
Typical Performance Characteristics	6	Ordering Guide	14

REVISION HISTORY

6/12—Rev. D to Rev. E

Changes to General Description Section; Added Table 1	1
Changes to Theory of Operation Section and Figure 16.....	9
Changes to Table 5.....	10
Changes to Input Selection Section; Deleted Large Input Voltages at Large Gains Section; Added Figure 18, Renumbered Sequentially	11
Changes to Ordering Guide	14

8/07—Rev. C to Rev. D

Updated Format.....	Universal
Added Thermal Resistance Section	5
Added Figure 16.....	9

Added Large Input Voltages at Large Gains Section	11
Replaced RF Interference Section	11
Deleted Grounding Section	10
Deleted Figure 16.....	10
Changes to Ground Returns for Input Bias Currents Section..	12
Updated Outline Dimensions.....	13
Changes to Ordering Guide	14

4/99—Rev. B to Rev. C

8/98—Rev. A to Rev. B

2/97—Rev. 0 to Rev. A

1/96—Revision 0: Initial Version

SPECIFICATIONS

$T_A = 25^\circ\text{C}$, $V_S = \pm 15\text{ V}$, and $R_L = 2\text{ k}\Omega$ typical, unless otherwise noted.

Table 2.

Parameter	Conditions	Min	Typ	Max	Unit
GAIN					
Gain Range	$G = 1 + (50.5\text{ k}/R_G)$	1		1000	
Gain Error ¹	$V_{OUT} = \pm 10\text{ V}$				
$G = 1$			0.05	0.15	%
$G = 10$			0.2	0.50	%
$G = 100$			0.2	0.50	%
$G = 1000$			0.2	0.50	%
Nonlinearity	$V_{OUT} = \pm 10\text{ V}$				
$G = 1$ to 1000	$R_L = 10\text{ k}\Omega$		10		ppm
$G = 1$ to 100	$R_L = 2\text{ k}\Omega$		10		ppm
Gain vs. Temperature	Gain = 1			10	ppm/ $^\circ\text{C}$
	Gain > 1 ¹			-50	ppm/ $^\circ\text{C}$
VOLTAGE OFFSET					
Input Offset, V_{OSI}	Total RTI Error = $V_{OSI} + V_{OSO}/G$				
Average Temperature Coefficient	$V_S = \pm 5\text{ V}$ to $\pm 15\text{ V}$		60	125	μV
Output Offset, V_{OSO}	$V_S = \pm 5\text{ V}$ to $\pm 15\text{ V}$			1.0	$\mu\text{V}/^\circ\text{C}$
Average Temperature Coefficient	$V_S = \pm 5\text{ V}$ to $\pm 15\text{ V}$		600	1500	μV
Offset Referred to Input vs. Supply (PSR)	$V_S = \pm 5\text{ V}$ to $\pm 15\text{ V}$			15	$\mu\text{V}/^\circ\text{C}$
$G = 1$		80	100		dB
$G = 10$		95	120		dB
$G = 100$		110	140		dB
$G = 1000$		110	140		dB
INPUT CURRENT					
Input Bias Current			2.0	5.0	nA
Average Temperature Coefficient			3.0		$\text{pA}/^\circ\text{C}$
Input Offset Current			0.7	2.5	nA
Average Temperature Coefficient			2.0		$\text{pA}/^\circ\text{C}$
INPUT					
Input Impedance					
Differential			10 2		$\text{G}\Omega \text{pF}$
Common Mode			10 2		$\text{G}\Omega \text{pF}$
Input Voltage Range ²	$V_S = \pm 2.6\text{ V}$ to $\pm 5\text{ V}$	$-V_S + 1.9$		$+V_S - 1.2$	V
Over Temperature		$-V_S + 2.1$		$+V_S - 1.3$	V
	$V_S = \pm 5\text{ V}$ to $\pm 18\text{ V}$	$-V_S + 1.9$		$+V_S - 1.4$	V
Over Temperature		$-V_S + 2.1$		$+V_S - 1.4$	V
Common-Mode Rejection Ratio	$V_{CM} = 0\text{ V}$ to $\pm 10\text{ V}$				
DC to 60 Hz with 1 k Ω Source Imbalance					
$G = 1$		66	78		dB
$G = 10$		86	98		dB
$G = 100$		103	118		dB
$G = 1000$		103	118		dB
OUTPUT					
Output Swing	$R_L = 10\text{ k}\Omega$				
Over Temperature	$V_S = \pm 2.6\text{ V}$ to $\pm 5\text{ V}$	$-V_S + 1.1$		$+V_S - 1.2$	V
		$-V_S + 1.4$		$+V_S - 1.3$	V
Over Temperature	$V_S = \pm 5\text{ V}$ to $\pm 18\text{ V}$	$-V_S + 1.2$		$+V_S - 1.4$	V
		$-V_S + 1.6$		$+V_S - 1.5$	V
Short Current Circuit			± 18		mA

Parameter	Conditions	Min	Typ	Max	Unit
DYNAMIC RESPONSE					
Small Signal –3 dB Bandwidth					
G = 1			1000		kHz
G = 10			800		kHz
G = 100			120		kHz
G = 1000			12		kHz
Slew Rate			1.2		V/ μ s
Settling Time to 0.1%	10 V step				
G = 1 to 100			10		μ s
NOISE					
Voltage Noise, 1 kHz	Total RTI Noise = $\sqrt{(e_{ni}^2) + (e_{no}/G)^2}$				
Input Voltage Noise, e_{ni}			12		nV/ $\sqrt{\text{Hz}}$
Output Voltage Noise, e_{no}			72		nV/ $\sqrt{\text{Hz}}$
RTI, 0.1 Hz to 10 Hz					
G = 1			4.0		μ V p-p
G = 10			0.6		μ V p-p
G = 100			0.3		μ V p-p
Current Noise	f = 1 kHz		100		fA/ $\sqrt{\text{Hz}}$
0.1 Hz to 10 Hz			10		pA p-p
REFERENCE INPUT					
R_{IN}			20		k Ω
I_{IN}	$V_{IN+}, V_{REF} = 0$		50	60	μ A
Voltage Range		$-V_S + 1.6$		$+V_S - 1.6$	V
Gain to Output			1 ± 0.0015		
POWER SUPPLY					
Operating Range ³		± 2.6		± 18	V
Quiescent Current	$V_S = \pm 2.6 \text{ V to } \pm 18 \text{ V}$		0.9	1.3	mA
Over Temperature			1.1	1.5	mA
TEMPERATURE RANGE					
For Specified Performance			$-40 \text{ to } +85$		$^{\circ}\text{C}$

¹ Does not include effects of External Resistor R_G .

² One input grounded, G = 1.

³ Defined as the same supply range that is used to specify PSR.

ABSOLUTE MAXIMUM RATINGS

Table 3.

Parameter	Rating
Supply Voltage	± 18 V
Internal Power Dissipation ¹	650 mW
Input Voltage (Common Mode)	$\pm V_s$
Differential Input Voltage ²	± 25 V
Output Short Circuit Duration	Indefinite
Storage Temperature Range	-65°C to $+125^\circ\text{C}$
Operating Temperature Range	-40°C to $+85^\circ\text{C}$
Lead Temperature (Soldering, 10 sec)	300°C

¹Specification is for device in free air; see Table 4.

²May be further restricted for gains greater than 14. See the Input Protection section for more information.

Stresses above those listed under Absolute Maximum Ratings may cause permanent damage to the device. This is a stress rating only; functional operation of the device at these or any other conditions above those indicated in the operational section of this specification is not implied. Exposure to absolute maximum rating conditions for extended periods may affect device reliability.

THERMAL RESISTANCE

θ_{JA} is specified for the device in free air.

Table 4. Thermal Resistance

Package Type	θ_{JA}	Unit
8-Lead PDIP (N-8)	95	$^\circ\text{C}/\text{W}$
8-Lead SOIC_N (R-8)	155	$^\circ\text{C}/\text{W}$

ESD CAUTION



ESD (electrostatic discharge) sensitive device. Charged devices and circuit boards can discharge without detection. Although this product features patented or proprietary protection circuitry, damage may occur on devices subjected to high energy ESD. Therefore, proper ESD precautions should be taken to avoid performance degradation or loss of functionality.

TYPICAL PERFORMANCE CHARACTERISTICS

$T_A = 25^\circ\text{C}$, $V_S = \pm 15\text{ V}$, $R_L = 2\text{ k}\Omega$, unless otherwise noted.



Figure 2. Typical Distribution of Output Offset Voltage

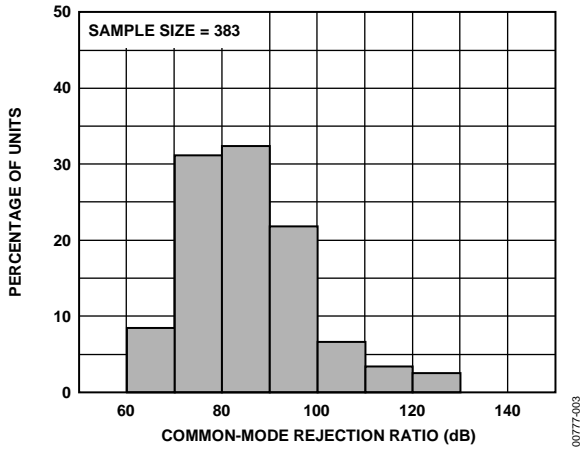

Figure 3. Typical Distribution of Common-Mode Rejection

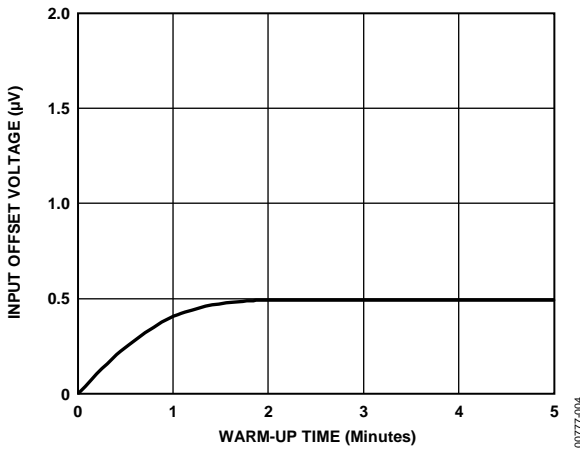

Figure 4. Change in Input Offset Voltage vs. Warm-Up Time



Figure 5. Voltage Noise Spectral Density vs. Frequency ($G = 1$ to 1000)



Figure 6. Current Noise Spectral Density vs. Frequency

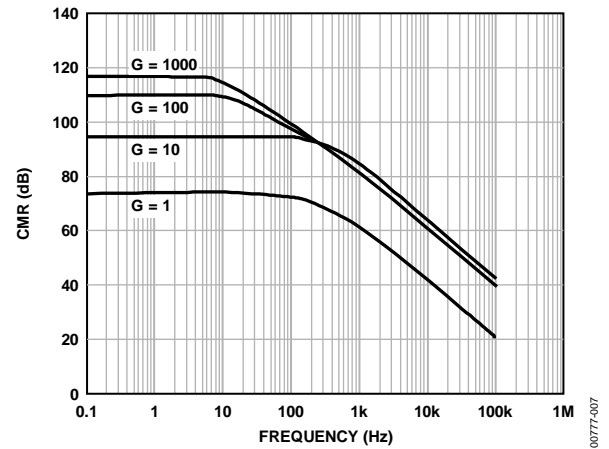

Figure 7. CMR vs. Frequency, RTI, $0\text{ k}\Omega$ to $1\text{ k}\Omega$ Source Imbalance

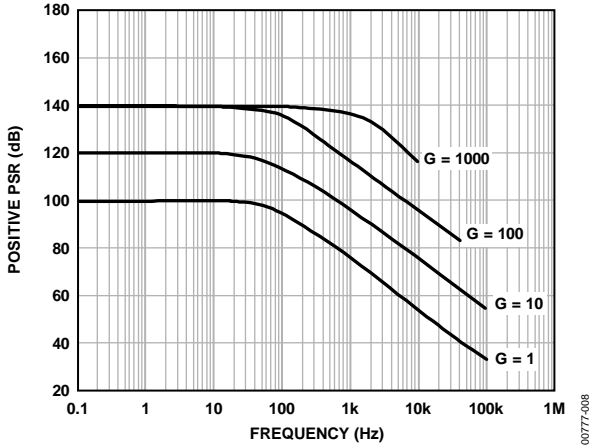

Figure 8. Positive PSR vs. Frequency, RTI (G = 1 to 1000)

00777-008

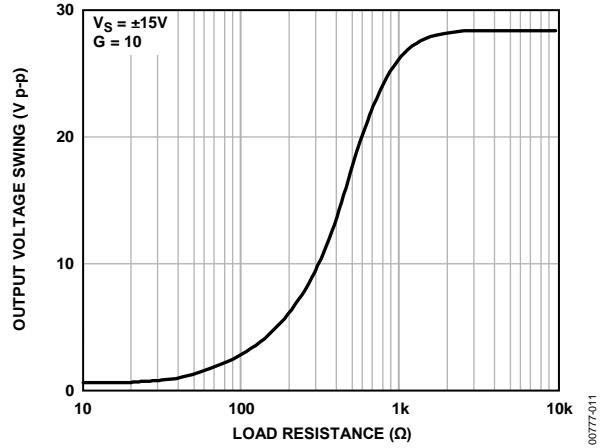

Figure 11. Output Voltage Swing vs. Load Resistance

00777-011

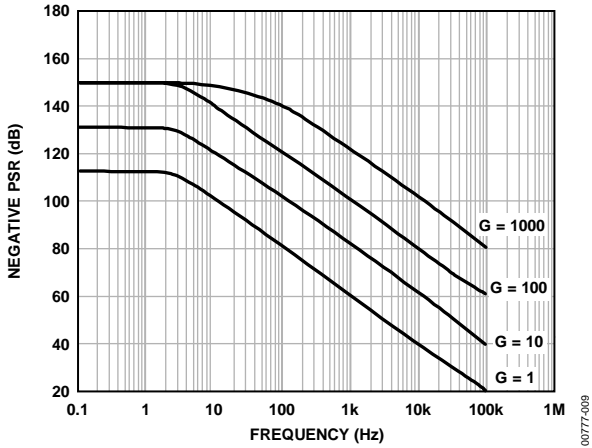

Figure 9. Negative PSR vs. Frequency, RTI (G = 1 to 1000)

00777-009

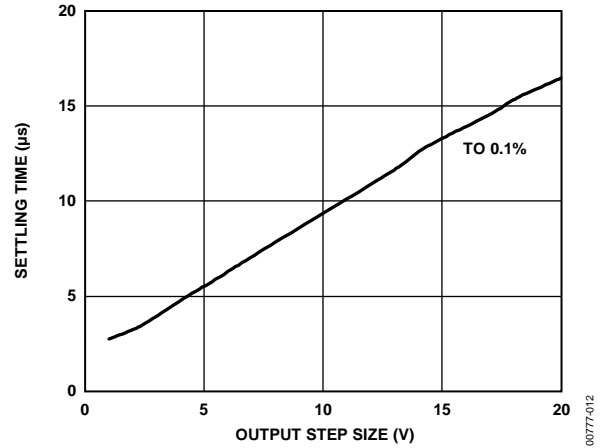

Figure 12. Settling Time vs. Step Size (G = 1)

00777-012

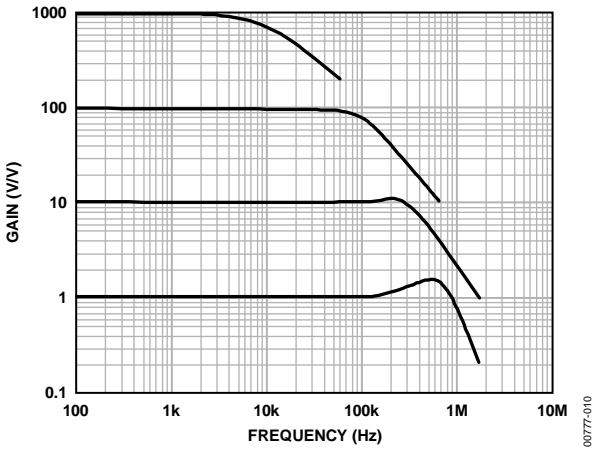

Figure 10. Gain vs. Frequency

00777-010

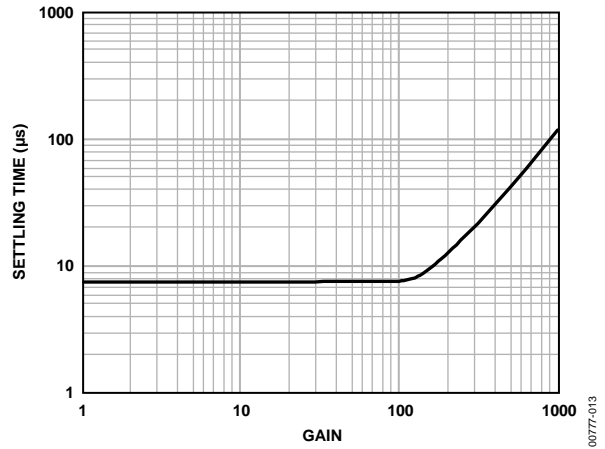

Figure 13. Settling Time to 0.1% vs. Gain, for a 10 V Step

00777-013



00777-014

Figure 14. Gain Nonlinearity, $G = 1$, $R_L = 10 \text{ k}\Omega$ ($20 \mu\text{V} = 2 \text{ ppm}$)



00777-015

Figure 15. Settling Time Test Circuit

THEORY OF OPERATION

The AD622 is a monolithic instrumentation amplifier based on a modification of the classic three op amp approach. Absolute value trimming allows the user to program gain accurately (to 0.5% at $G = 1000$) with only one resistor. Monolithic construction and laser wafer trimming allow the tight matching and tracking of circuit components, thus insuring AD622 performance.

Input Transistor Q1 and Input Transistor Q2 provide a single differential-pair bipolar input for high precision (see Figure 16). Feedback through the Q1-A1-R1 loop and the Q2-A2-R2 loop maintains constant collector current of the Q1 and Q2 input devices, thereby impressing the input voltage across External Gain-Setting Resistor R_G . This creates a differential gain from the inputs to the A1 and A2 outputs given by $G = (R1 + R2)/R_G + 1$. Unity-Gain Subtractor A3 removes any common-mode signal, yielding a single-ended output referred to the REF pin potential.

The value of R_G also determines the transconductance of the preamp stage. As R_G is reduced for larger gains, the transconductance increases asymptotically to that of the input transistors. This has the following three important advantages:

- Open-loop gain is boosted for increasing programmed gain, thus reducing gain-related errors.
- The gain-bandwidth product (determined by C1, C2, and the preamp transconductance) increases with programmed gain, thus optimizing frequency response.
- The input voltage noise is reduced to a value of $12 \text{ nV}/\sqrt{\text{Hz}}$, determined mainly by the collector current and base resistance of the input devices.

The internal gain resistors, R1 and R2, are trimmed to an absolute value of $25.25 \text{ k}\Omega$, allowing the gain to be programmed accurately with a single external resistor.

MAKE vs. BUY: A TYPICAL APPLICATION ERROR BUDGET

The AD622 offers cost and performance advantages over discrete two op amp instrumentation amplifier designs along with smaller size and fewer components. In a typical application shown in Figure 17, a gain of 10 is required to receive and amplify a 0 to 20 mA signal from the AD694 current transmitter. The current is converted to a voltage in a 50Ω shunt. In applications where transmission is over long distances, line impedance can be significant so that differential voltage measurement is essential. Where there is no connection between the ground returns of transmitter and receiver, there must be a dc path from each input to ground, implemented in this case using two $1 \text{ k}\Omega$ resistors. The error budget detailed in Table 5 shows how to calculate the effect of various error sources on circuit accuracy.



Figure 16. Simplified Schematic of the AD622



Figure 17. Make vs. Buy

The AD622 provides greater accuracy at lower cost. The higher cost of the homebrew circuit is dominated in this case by the matched resistor network. One could also realize a homebrew design using cheaper discrete resistors that are either trimmed or hand selected to give high common-mode rejection. This level of common-mode rejection, however, degrades significantly

over temperature due to the drift mismatch of the discrete resistors.

Note that for the homebrew circuit, the LT1013 specification for noise has been multiplied by $\sqrt{2}$. This is because a two op amp type instrumentation amplifier has two op amps at its inputs, both contributing to the overall noise.

Table 5. Make vs. Buy Error Budget

Error Source	AD622 Circuit Calculation	Homebrew Circuit Calculation	Total Error in ppm Relative to 1 V FS	
			AD622	Homebrew
ABSOLUTE ACCURACY at $T_A = 25^\circ\text{C}$				
Total RTI Offset Voltage, μV	$125 \mu\text{V} + 1500 \mu\text{V}/10$	$800 \mu\text{V} \times 2$	275	1600
Input Offset Current, nA	$2.5 \text{ nA} \times 1 \text{ k}\Omega$	$15 \text{ nA} \times 1 \text{ k}\Omega$	2.5	15
CMR, dB	$86 \text{ dB} \rightarrow 50 \text{ ppm} \times 0.5 \text{ V}$	$(0.1\% \text{ Match} \times 0.5 \text{ V})/10 \text{ V}$	25	50
		Total Absolute Error	302.5	1665
DRIFT TO 85°C				
Gain Drift, ppm/ $^\circ\text{C}$	$(50 \text{ ppm} + 5 \text{ ppm}) \times 60^\circ\text{C}$	$(50 \text{ ppm})/^\circ\text{C} \times 60^\circ\text{C}$	3300	3000
Total RTI Offset Voltage, $\mu\text{V}/^\circ\text{C}$	$(1 \mu\text{V}/^\circ\text{C} + 15 \mu\text{V}/^\circ\text{C}/10) \times 60^\circ\text{C}$	$9 \mu\text{V}/^\circ\text{C} \times 2 \times 60^\circ\text{C}$	150	1080
Input Offset Current, pA/ $^\circ\text{C}$	$2 \text{ pA}/^\circ\text{C} \times 1 \text{ k}\Omega \times 60^\circ\text{C}$	$155 \text{ pA}/^\circ\text{C} \times 1 \text{ k}\Omega \times 60^\circ\text{C}$	0.12	9.3
		Total Drift Error	3450.12	4089.3
RESOLUTION				
Gain Nonlinearity, ppm of Full Scale	10 ppm	20 ppm	10	20
Typ 0.1 Hz to 10 Hz Voltage Noise, μV p-p	0.6 μV p-p	$0.55 \mu\text{V} \text{ p-p} \times \sqrt{2}$	0.6	0.778
		Total Resolution Error	10.6	20.778
		Grand Total Error	3763	5775

GAIN SELECTION

The AD622 gain is resistor programmed by R_G or, more precisely, by whatever impedance appears between Pin 1 and Pin 8. The AD622 is designed to offer gains as close as possible to popular integer values using standard 1% resistors. Table 6 shows required values of R_G for various gains. Note that for $G = 1$, the R_G pins are unconnected ($R_G = \infty$). For any arbitrary gain, R_G can be calculated by using the formula

$$R_G = \frac{50.5 \text{ k}\Omega}{G - 1}$$

To minimize gain error, avoid high parasitic resistance in series with R_G . To minimize gain drift, R_G should have a low temperature coefficient less than 10 ppm/°C for the best performance.

Table 6. Required Values of Gain Resistors

Desired Gain	1% Std Table Value of R_G , Ω	Calculated Gain
2	51.1 k	1.988
5	12.7 k	4.976
10	5.62 k	9.986
20	2.67 k	19.91
33	1.58 k	32.96
40	1.3 k	39.85
50	1.02 k	50.50
65	787	65.17
100	511	99.83
200	255	199.0
500	102	496.1
1000	51.1	989.3

INPUT AND OUTPUT OFFSET VOLTAGE

The low errors of the AD622 are attributable to two sources: input and output errors. The output error is divided by G when referred to the input. In practice, the input errors dominate at high gains and the output errors dominate at low gains. The total V_{OS} for a given gain is calculated as follows:

$$\text{Total Error RTI} = \text{input error} + (\text{output error}/G)$$

$$\text{Total Error RTO} = (\text{input error} \times G) + \text{output error}$$

REFERENCE TERMINAL

The reference terminal potential defines the zero output voltage and is especially useful when the load does not share a precise ground with the rest of the system. The reference terminal provides a direct means of injecting a precise offset to the output, with an allowable range of 2 V within the supply voltages. Parasitic resistance should be kept to a minimum for optimum CMR.

INPUT PROTECTION

The AD622 safely withstands an input current of ± 60 mA for several hours at room temperature. This is true for all gains and power on and off, which is useful if the signal source and amplifier are powered separately. For longer time periods, the input current should not exceed 6 mA.

For input voltages beyond the supplies, a protection resistor should be placed in series with each input to limit the current to 6 mA. These can be the same resistors as those used in the RFI filter. High values of resistance can impact the noise and AC CMRR performance of the system. Low leakage diodes (such as the BAV199) can be placed at the inputs to reduce the required protection resistance.

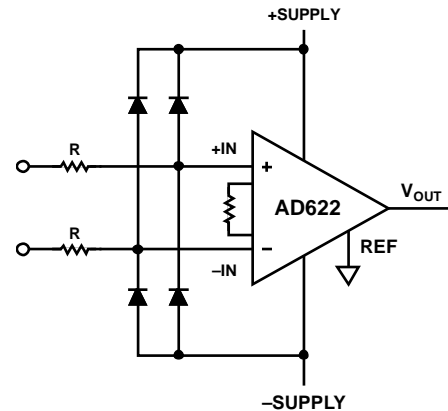

Figure 18. Diode Protection for Voltages Beyond Supply

RF INTERFERENCE

RF rectification is often a problem when amplifiers are used in applications where there are strong RF signals. The disturbance may appear as a small dc offset voltage. High frequency signals can be filtered with a low-pass, RC network placed at the input of the instrumentation amplifier, as shown in Figure 19. In addition, this RC input network also provides additional input overload protection (see the Input Protection section).



Figure 19. RFI Suppression Circuit for AD622 Series In-Amps

The filter limits the input signal bandwidth to the following cutoff frequencies:

$$FilterFreq_{DIFF} = \frac{1}{2\pi R(2C_D + C_C)}$$

$$FilterFreq_{CM} = \frac{1}{2\pi RC_C}$$

where $C_D \geq 10C_C$.

Figure 19 shows an example where the differential filter frequency is approximately 400 Hz, and the common-mode filter frequency is approximately 40 kHz. With this differential filter in place and operating at gain of 1000, the typical dc offset shift over a frequency range of 1 Hz to 20 MHz is less than 1.5 μ V RTI, and the RF signal rejection of the circuit is better than 71 dB. At a gain of 100, the dc offset shift is well below 1 mV RTI, and RF rejection is greater than 70 dB.

The input resistors should be selected to be high enough to isolate the sensor from the C_C and C_D capacitors but low enough not to influence system noise. Mismatch between $R \times C_C$ at the positive input and $R \times C_C$ at the negative input degrades the CMRR of the AD622. Therefore, the C_C capacitors should be high precision types such as NPO/COG ceramics. The tolerance of the C_D capacitor is less critical.

GROUND RETURNS FOR INPUT BIAS CURRENTS

Input bias currents are those currents necessary to bias the input transistors of an amplifier. There must be a direct return path for these currents; therefore, when amplifying floating input sources such as transformers or ac-coupled sources, there must be a dc path from each input to ground as shown in Figure 20, Figure 21, and Figure 22. Refer to the *Designer's Guide to Instrumentation Amplifiers* (free from Analog Devices, Inc.) for more information regarding in-amp applications.



Figure 20. Ground Returns for Bias Currents with Transformer Coupled Inputs



Figure 21. Ground Returns for Bias Currents with Thermocouple Inputs



Figure 22. Ground Returns for Bias Currents with AC-Coupled Inputs

OUTLINE DIMENSIONS



COMPLIANT TO JEDEC STANDARDS MS-001
 CONTROLLING DIMENSIONS ARE IN INCHES; MILLIMETER DIMENSIONS (IN PARENTHESES) ARE ROUNDED-OFF INCH EQUIVALENTS FOR REFERENCE ONLY AND ARE NOT APPROPRIATE FOR USE IN DESIGN. CORNER LEADS MAY BE CONFIGURED AS WHOLE OR HALF LEADS.

Figure 23. 8-Lead Plastic Dual In-Line Package [PDIP] Narrow Body (N-8)

Dimensions shown in inches and (millimeters)

070606-A

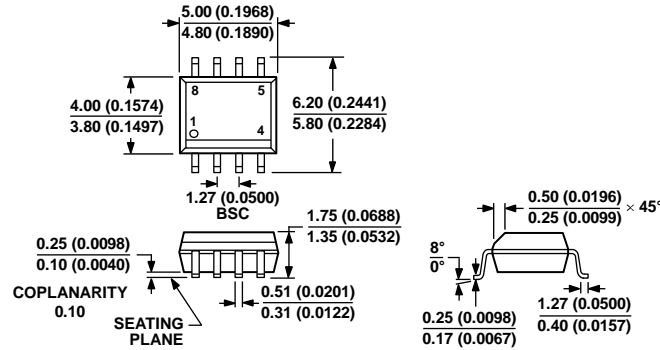

COMPLIANT TO JEDEC STANDARDS MS-012-AA
 CONTROLLING DIMENSIONS ARE IN MILLIMETERS; INCH DIMENSIONS (IN PARENTHESES) ARE ROUNDED-OFF MILLIMETER EQUIVALENTS FOR REFERENCE ONLY AND ARE NOT APPROPRIATE FOR USE IN DESIGN.

Figure 24. 8-Lead Standard Small Outline Package [SOIC_N] Narrow Body (R-8)

Dimensions shown in millimeters and (inches)

012407-A

ORDERING GUIDE

Model¹	Temperature Range	Package Description	Package Option
AD622ANZ	-40°C to +85°C	8-Lead PDIP	N-8
AD622AR	-40°C to +85°C	8-Lead SOIC_N	R-8
AD622AR-REEL	-40°C to +85°C	8-Lead SOIC_N	R-8
AD622AR-REEL7	-40°C to +85°C	8-Lead SOIC_N	R-8
AD622ARZ	-40°C to +85°C	8-Lead SOIC_N	R-8
AD622ARZ-RL	-40°C to +85°C	8-Lead SOIC_N	R-8
AD622ARZ-R7	-40°C to +85°C	8-Lead SOIC_N	R-8

¹ Z = RoHS Compliant Part.

NOTES

NOTES

Компания «Океан Электроники» предлагает заключение долгосрочных отношений при поставках импортных электронных компонентов на взаимовыгодных условиях!

Наши преимущества:

- Поставка оригинальных импортных электронных компонентов напрямую с производств Америки, Европы и Азии, а так же с крупнейших складов мира;
- Широкая линейка поставок активных и пассивных импортных электронных компонентов (более 30 млн. наименований);
- Поставка сложных, дефицитных, либо снятых с производства позиций;
- Оперативные сроки поставки под заказ (от 5 рабочих дней);
- Экспресс доставка в любую точку России;
- Помощь Конструкторского Отдела и консультации квалифицированных инженеров;
- Техническая поддержка проекта, помощь в подборе аналогов, поставка прототипов;
- Поставка электронных компонентов под контролем ВП;
- Система менеджмента качества сертифицирована по Международному стандарту ISO 9001;
- При необходимости вся продукция военного и аэрокосмического назначения проходит испытания и сертификацию в лаборатории (по согласованию с заказчиком);
- Поставка специализированных компонентов военного и аэрокосмического уровня качества (Xilinx, Altera, Analog Devices, Intersil, Interpoint, Microsemi, Actel, Aeroflex, Peregrine, VPT, Syfer, Eurofarad, Texas Instruments, MS Kennedy, Miteq, Cobham, E2V, MA-COM, Hittite, Mini-Circuits, General Dynamics и др.);

Компания «Океан Электроники» является официальным дистрибьютором и эксклюзивным представителем в России одного из крупнейших производителей разъемов военного и аэрокосмического назначения «JONHON», а так же официальным дистрибьютором и эксклюзивным представителем в России производителя высокотехнологичных и надежных решений для передачи СВЧ сигналов «FORSTAR».



JONHON

«JONHON» (основан в 1970 г.)

Разъемы специального, военного и аэрокосмического назначения:

(Применяются в военной, авиационной, аэрокосмической, морской, железнодорожной, горно- и нефтедобывающей отраслях промышленности)

«FORSTAR» (основан в 1998 г.)

ВЧ соединители, коаксиальные кабели, кабельные сборки и микроволновые компоненты:

(Применяются в телекоммуникациях гражданского и специального назначения, в средствах связи, РЛС, а так же военной, авиационной и аэрокосмической отраслях промышленности).



Телефон: 8 (812) 309-75-97 (многоканальный)

Факс: 8 (812) 320-03-32

Электронная почта: ocean@oceanchips.ru

Web: <http://oceanchips.ru/>

Адрес: 198099, г. Санкт-Петербург, ул. Калинина, д. 2, корп. 4, лит. А