

## ADR121/ADR125/ADR127

### FEATURES

#### Initial accuracy

A grade:  $\pm 0.24\%$

B grade:  $\pm 0.12\%$

#### Maximum tempco

A grade: 25 ppm/ $^{\circ}\text{C}$

B grade: 9 ppm/ $^{\circ}\text{C}$

Low dropout: 300 mV for ADR121, ADR125

High output current: +5 mA/−2 mA

Low typical operating current: 85  $\mu\text{A}$

Input range: 2.7 V to 18 V

Temperature range:  $-40^{\circ}\text{C}$  to  $+125^{\circ}\text{C}$

Tiny TSOT (UJ-6) package

### APPLICATIONS

Battery-powered instrumentation

Portable medical equipment

Data acquisition systems

Automotive

### GENERAL DESCRIPTION

The ADR121/ADR125/ADR127 are a family of micropower, high precision, series mode, band gap references with sink and source capability. The parts feature high accuracy and low power consumption in a tiny package. The ADR12x design includes a patented temperature drift curvature correction technique that minimizes the nonlinearities in the output voltage vs. temperature characteristics.

The ADR12x is a low dropout voltage reference, requiring only 300 mV for ADR121/ADR125 and 1.45 V for ADR127 above the nominal output voltage on the input to provide a stable output voltage. This low dropout performance coupled with the low 85  $\mu\text{A}$  operating current makes the ADR12x ideal for battery-powered applications.

Available in an extended industrial temperature range of  $-40^{\circ}\text{C}$  to  $+125^{\circ}\text{C}$ , the ADR12x is housed in the tiny TSOT (UJ-6) package.

### PIN CONFIGURATION

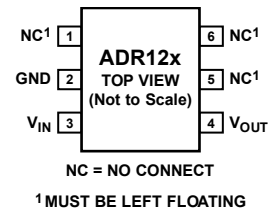

Figure 1.

05725-001

#### Rev. 0

Information furnished by Analog Devices is believed to be accurate and reliable. However, no responsibility is assumed by Analog Devices for its use, nor for any infringements of patents or other rights of third parties that may result from its use. Specifications subject to change without notice. No license is granted by implication or otherwise under any patent or patent rights of Analog Devices. Trademarks and registered trademarks are the property of their respective owners.

## TABLE OF CONTENTS

Features .....	1	Terminology .....	7
Applications.....	1	Typical Performance Characteristics .....	8
Pin Configuration.....	1	Theory of Operation .....	16
General Description .....	1	Power Dissipation Considerations.....	16
Revision History .....	2	Notes .....	16
Specifications.....	3	Applications.....	17
ADR121 Electrical Characteristics.....	3	Basic Voltage Reference Connection .....	17
ADR125 Electrical Characteristics.....	4	Stacking Reference ICs for Arbitrary Outputs .....	17
ADR127 Electrical Characteristics.....	5	Negative Precision Reference Without Precision Resistors..	17
Absolute Maximum Ratings.....	6	General-Purpose Current Source .....	17
Thermal Resistance .....	6	Outline Dimensions .....	18
ESD Caution.....	6	Ordering Guide .....	18

## REVISION HISTORY

6/06—Revision 0: Initial Version

## SPECIFICATIONS

### ADR121 ELECTRICAL CHARACTERISTICS

@  $T_A = 25^\circ\text{C}$ ,  $V_{IN} = 2.8\text{ V to }18\text{ V}$ ,  $I_{OUT} = 0\text{ mA}$ , unless otherwise noted.

Table 1.

Parameter	Symbol	Conditions/Comments	Min	Typ	Max	Unit
OUTPUT VOLTAGE	$V_O$	@ $25^\circ\text{C}$				
B Grade			2.497	2.5	2.503	V
A Grade			2.494	2.5	2.506	V
INITIAL ACCURACY ERROR	$V_{OERR}$	@ $25^\circ\text{C}$				
B Grade			-0.12		+0.12	%
A Grade			-0.24		+0.24	%
TEMPERATURE COEFFICIENT	$TCV_O$	$-40^\circ\text{C} < T_A < +125^\circ\text{C}$				
B Grade				3	9	ppm/ $^\circ\text{C}$
A Grade				15	25	ppm/ $^\circ\text{C}$
DROPOUT ( $V_{OUT} - V_{IN}$ )	$V_{DO}$	$I_{OUT} = 0\text{ mA}$	300			mV
LOAD REGULATION		$-40^\circ\text{C} < T_A < +125^\circ\text{C}$ ; $V_{IN} = 3.0\text{ V}$ , $0\text{ mA} < I_{OUT} < 5\text{ mA}$		80	300	ppm/mA
		$-40^\circ\text{C} < T_A < +125^\circ\text{C}$ ; $V_{IN} = 3.0\text{ V}$ , $-2\text{ mA} < I_{OUT} < 0\text{ mA}$		50	300	ppm/mA
LINE REGULATION		$2.8\text{ V to }18\text{ V}$ $I_{OUT} = 0\text{ mA}$	-50	+3	+50	ppm/V
PSRR		$f = 1\text{ KHz}$		-90		dB
RIPPLE REJECTION	$\Delta V_{OUT}/\Delta V_{IN}$	$f = 60\text{ Hz}$		60		dB
QUIESCENT CURRENT	$I_Q$	$-40^\circ\text{C} < T_A < +125^\circ\text{C}$ , no load $V_{IN} = 18\text{ V}$ $V_{IN} = 2.8\text{ V}$		95 80	125 95	$\mu\text{A}$ $\mu\text{A}$
SHORT-CIRCUIT CURRENT TO GROUND		$V_{IN} = 2.8\text{ V}$ $V_{IN} = 18\text{ V}$		18 40		mA mA
VOLTAGE NOISE		@ $25^\circ\text{C}$ $f = 10\text{ KHz}$ 0.1 Hz to 10 Hz		500 10		nV/ $\sqrt{\text{Hz}}$ $\mu\text{V p-p}$
TURN-ON SETTLING TIME		To 0.1%, $C_L = 0.2\text{ }\mu\text{F}$		100		$\mu\text{s}$
LONG-TERM STABILITY		1000 hours @ $25^\circ\text{C}$		150		ppm/1000 hrs
OUTPUT VOLTAGE HYSTERESIS		See the Terminology section		300		ppm

# ADR121/ADR125/ADR127

## ADR125 ELECTRICAL CHARACTERISTICS

@  $T_A = 25^\circ\text{C}$ ,  $V_{IN} = 5.3\text{ V}$  to  $18\text{ V}$ ,  $I_{OUT} = 0\text{ mA}$ , unless otherwise noted.

Table 2.

Parameter	Symbol	Condition	Min	Typ	Max	Unit
OUTPUT VOLTAGE	$V_O$	@ $25^\circ\text{C}$				
B Grade			4.994	5.0	5.006	V
A Grade		2.497	4.988	5.0	5.012	V
INITIAL ACCURACY ERROR	$V_{OERR}$	@ $25^\circ\text{C}$				
B Grade			-0.12		+0.12	%
A Grade			-0.24		+0.24	%
TEMPERATURE COEFFICIENT	$TCV_O$	$-40^\circ\text{C} < T_A < +125^\circ\text{C}$				
B Grade				3	9	ppm/ $^\circ\text{C}$
A Grade				15	25	ppm/ $^\circ\text{C}$
DROPOUT ( $V_{OUT} - V_{IN}$ )	$V_{DO}$	$I_{OUT} = 5\text{ mA}$	300			mV
LOAD REGULATION		$-40^\circ\text{C} < T_A < +125^\circ\text{C}$ ; $V_{IN} = 3.0\text{ V}$ , $0\text{ mA} < I_{OUT} < 5\text{ mA}$		35	200	ppm/mA
		$-40^\circ\text{C} < T_A < +125^\circ\text{C}$ ; $V_{IN} = 3.0\text{ V}$ , $-2\text{ mA} < I_{OUT} < 0\text{ mA}$		35	200	ppm/mA
LINE REGULATION		$5.3\text{ V} < V_{IN} < 18\text{ V}$ $I_{OUT} = 0\text{ mA}$			30	ppm/V
PSRR		$f = 60\text{ Hz}$		-90		dB
RIPPLE REJECTION	$\Delta V_{OUT}/\Delta V_{IN}$	$f = 60\text{ Hz}$		60		dB
QUIESCENT CURRENT	$I_Q$	$-40^\circ\text{C} < T_A < +125^\circ\text{C}$ , no load $V_{IN} = 18\text{ V}$ $V_{IN} = 3.0\text{ V}$		95 80	125 95	$\mu\text{A}$ $\mu\text{A}$
SHORT-CIRCUIT CURRENT TO GROUND		$V_{IN} = 5.3\text{ V}$ $V_{IN} = 18\text{ V}$		25 40		mA mA
VOLTAGE NOISE		@ $25^\circ\text{C}$ $f = 10\text{ KHz}$ 0.1 Hz to 10 Hz		900 20		nV/ $\sqrt{\text{Hz}}$ $\mu\text{V p-p}$
TURN-ON SETTLING TIME		To 0.1%, $C_L = 0.2\ \mu\text{F}$		100		$\mu\text{s}$
LONG-TERM STABILITY		1000 hours @ $25^\circ\text{C}$		150		ppm/1000 hrs
OUTPUT VOLTAGE HYSTERESIS		See the Terminology section		300		ppm

**ADR127 ELECTRICAL CHARACTERISTICS**

@  $T_A = 25^\circ\text{C}$ , 2.7 V to 18 V,  $I_{\text{OUT}} = 0$  mA, unless otherwise noted.

**Table 3.**

Parameter	Symbol	Condition	Min	Typ	Max	Unit
OUTPUT VOLTAGE	$V_O$	@ $25^\circ\text{C}$				
B Grade			1.2485	1.25	1.2515	V
A Grade			1.2470	1.25	1.2530	V
INITIAL ACCURACY ERROR	$V_{\text{OERR}}$	@ $25^\circ\text{C}$				
B Grade			-0.12		+0.12	%
A Grade			-0.24		+0.24	%
TEMPERATURE COEFFICIENT	$\text{TCV}_O$	$-40^\circ\text{C} < T_A < +125^\circ\text{C}$				
B Grade				3	9	ppm/ $^\circ\text{C}$
A Grade			15	25	ppm/ $^\circ\text{C}$	
DROPOUT ( $V_{\text{OUT}} - V_{\text{IN}}$ )	$V_{\text{DO}}$	$I_{\text{OUT}} = 0$ mA	1.45			V
LOAD REGULATION		$-40^\circ\text{C} < T_A < +125^\circ\text{C}; V_{\text{IN}} = 3.0$ V, $0$ mA $< I_{\text{OUT}} < 5$ mA		85	400	ppm/mA
		$-40^\circ\text{C} < T_A < +125^\circ\text{C}; V_{\text{IN}} = 3.0$ V, $-2$ mA $< I_{\text{OUT}} < 0$ mA		65	400	ppm/mA
LINE REGULATION		2.7 V to 18 V $I_{\text{OUT}} = 0$ mA		30	90	ppm/V
PSRR		F = 60 Hz		-90		dB
RIPPLE REJECTION	$\Delta V_{\text{OUT}}/\Delta V_{\text{IN}}$	f = 60 Hz		60		dB
QUIESCENT CURRENT	$I_Q$	$-40^\circ\text{C} < T_A < +125^\circ\text{C}$ , no load $V_{\text{IN}} = 18$ V $V_{\text{IN}} = 2.7$ V		95	125	$\mu\text{A}$
					80	95
SHORT-CIRCUIT CURRENT TO GROUND		$V_{\text{IN}} = 2.7$ V $V_{\text{IN}} = 18$ V		15 30		mA mA
VOLTAGE NOISE		@ $25^\circ\text{C}$				
Noise Density		f = 10 kHz 0.1 Hz to 10 Hz		300 5		nV/ $\sqrt{\text{Hz}}$ $\mu\text{V p-p}$
TURN-ON SETTLING TIME		To 0.1%, $C_L = 0.2$ $\mu\text{F}$		80		$\mu\text{s}$
LONG-TERM STABILITY		1000 hours @ $25^\circ\text{C}$		150		ppm/1000 hrs
OUTPUT VOLTAGE HYSTERESIS		See the Terminology section		300		ppm

# ADR121/ADR125/ADR127

## ABSOLUTE MAXIMUM RATINGS

Table 4.

Parameter	Ratings
$V_{IN}$ to GND	20 V
Internal Power Dissipation TSOT (UJ-6)	40 mW
Storage Temperature Range	-65°C to +150°C
Specified Temperature Range	-40°C to +125°C
Lead Temperature, Soldering Vapor Phase (60 sec)	215°C
Infrared (15 sec)	220°C

Stresses above those listed under Absolute Maximum Ratings may cause permanent damage to the device. This is a stress rating only; functional operation of the device at these or any other conditions above those indicated in the operational section of this specification is not implied. Exposure to absolute maximum rating conditions for extended periods may affect device reliability.

### THERMAL RESISTANCE

$\theta_{JA}$  is specified for the worst-case conditions, that is, a device soldered in a circuit board for surface-mount packages.

Table 5. Thermal Resistance

Package Type	$\theta_{JA}$	$\theta_{JC}$	Unit
TSOT (UJ-6)	230	146	°C/W

### ESD CAUTION

ESD (electrostatic discharge) sensitive device. Electrostatic charges as high as 4000 V readily accumulate on the human body and test equipment and can discharge without detection. Although this product features proprietary ESD protection circuitry, permanent damage may occur on devices subjected to high energy electrostatic discharges. Therefore, proper ESD precautions are recommended to avoid performance degradation or loss of functionality.



## TERMINOLOGY

### Temperature Coefficient

The change of output voltage with respect to operating temperature change normalized by the output voltage at 25°C. This parameter is expressed in ppm/°C and can be determined by

$$TCV_o \text{ [ppm/°C]} = \frac{V_o(T_2) - V_o(T_1)}{V_o(25^\circ\text{C}) \times (T_2 - T_1)} \times 10^6$$

where:

$V_o(25^\circ\text{C}) = V_o$  at 25°C.

$V_o(T_1) = V_o$  at Temperature 1.

$V_o(T_2) = V_o$  at Temperature 2.

### Line Regulation

The change in the output due to a specified change in input voltage. This parameter accounts for the effects of self-heating. Line regulation is expressed in either percent per volt, parts-per-million per volt, or microvolts per voltage changes in input voltage.

### Load Regulation

The change in output voltage due to a specified change in load current. This parameter accounts for the effects of self-heating. Load regulation is expressed in either microvolts per milliamper, parts-per-million per milliamper, or ohms of dc output resistance.

### Long-Term Stability

Typical shift of output voltage at 25°C on a sample of parts subjected to a test of 1000 hours at 25°C.

$$\Delta V_o = V_o(t_o) - V_o(t_1)$$

$$\Delta V_o \text{ [ppm]} = \frac{V_o(t_o) - V_o(t_1)}{V_o(t_o)} \times 10^6$$

where:

$V_o(t_o) = V_o$  at 25°C at Time 0.

$V_o(t_1) = V_o$  at 25°C after 1000 hours operating at 25°C.

### Thermal Hysteresis

The change of output voltage after the device is cycled through temperatures from +25°C to -40°C to +125°C and back to +25°C. This is a typical value from a sample of parts put through such a cycle.

where:

$V_o(25^\circ\text{C}) = V_o$  at 25°C.

$V_{OTC} = V_o$  at 25°C after temperature cycle at +25°C to -40°C to +125°C and back to +25°C.

## TYPICAL PERFORMANCE CHARACTERISTICS

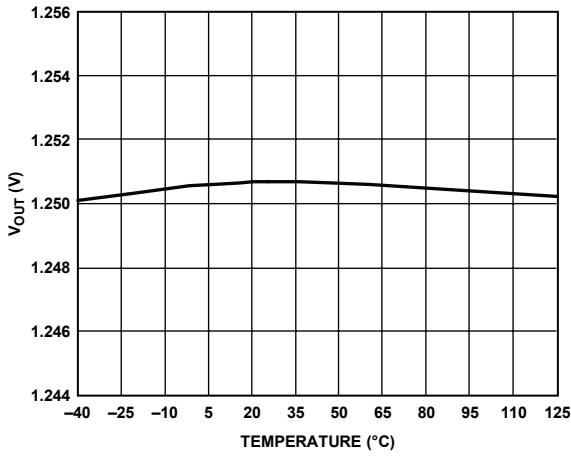

Figure 2. ADR127  $V_{OUT}$  vs. Temperature

05725-006

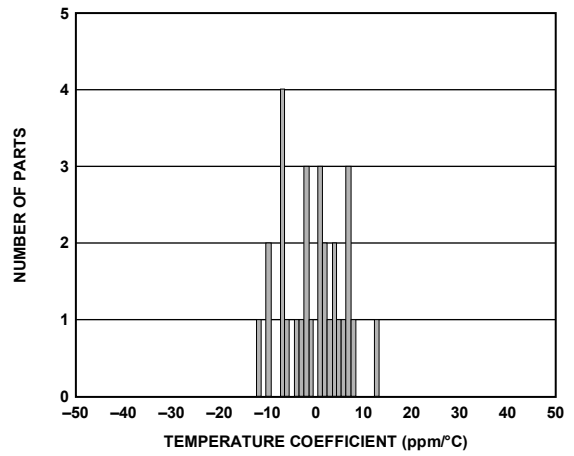

Figure 5. ADR127 Temperature Coefficient

05725-009

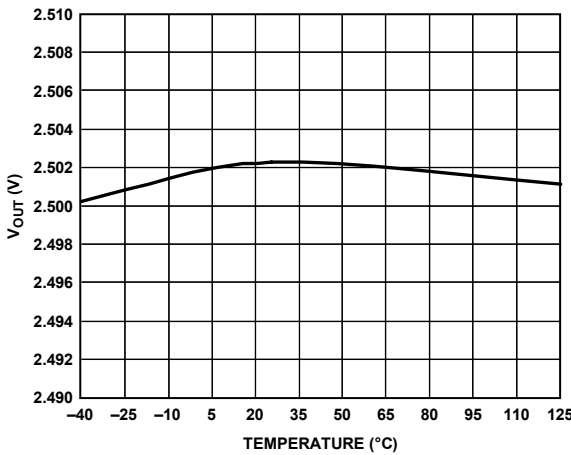

Figure 3. ADR121  $V_{OUT}$  vs. Temperature

05725-007

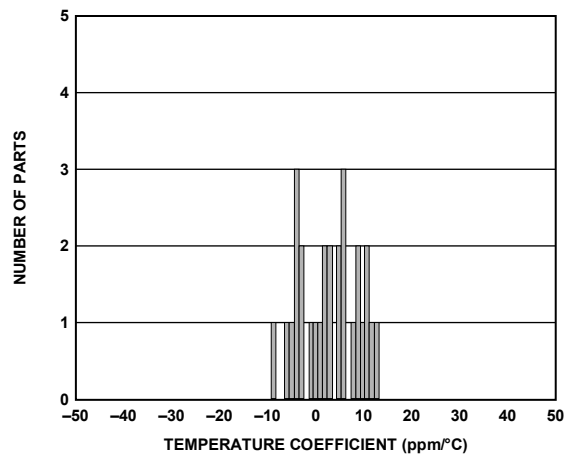

Figure 6. ADR125 Temperature Coefficient

05725-010

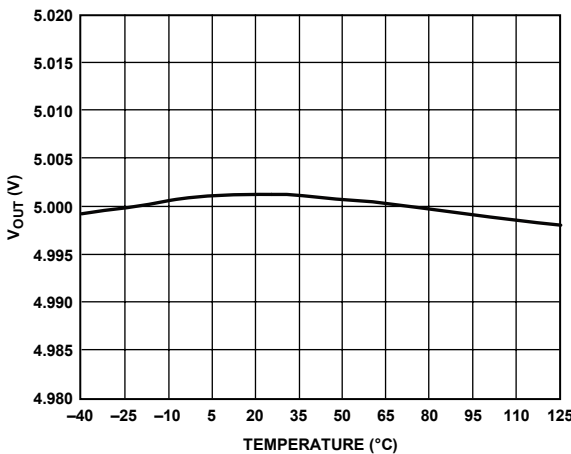

Figure 4. ADR125  $V_{OUT}$  vs. Temperature

05725-008

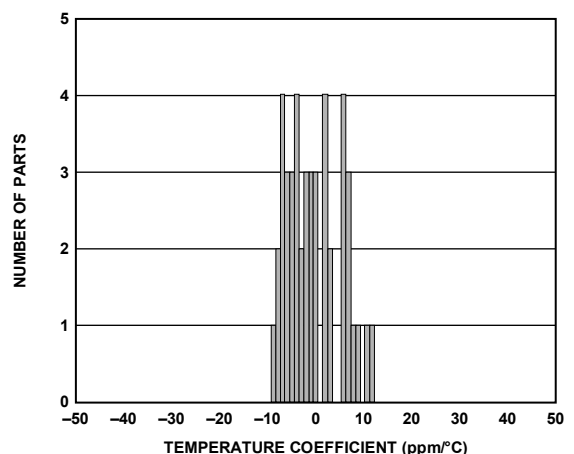

Figure 7. ADR121 Temperature Coefficient

05725-011



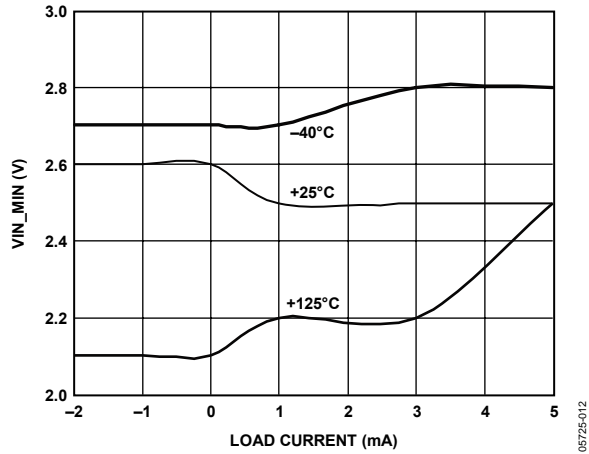

Figure 8. ADR127 Minimum Input Voltage vs. Load Current

05725-012

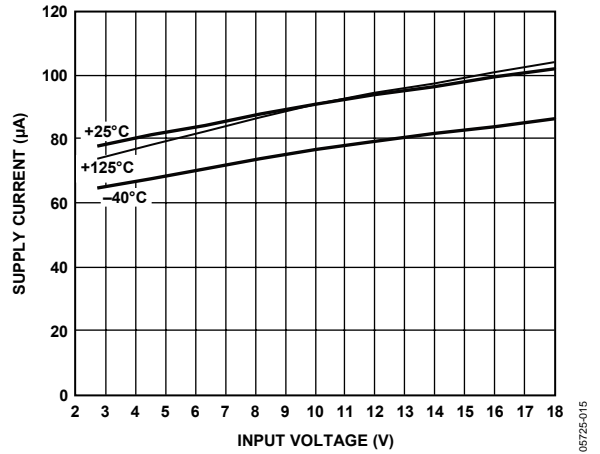

Figure 11. ADR127 Supply Current vs. Input Voltage

05725-015

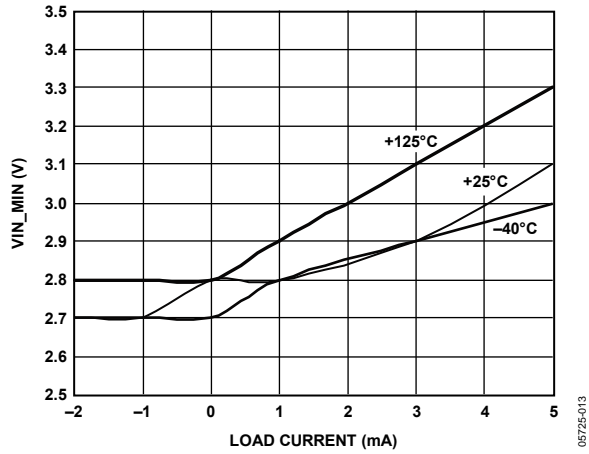

Figure 9. ADR121 Minimum Input Voltage vs. Load Current

05725-013

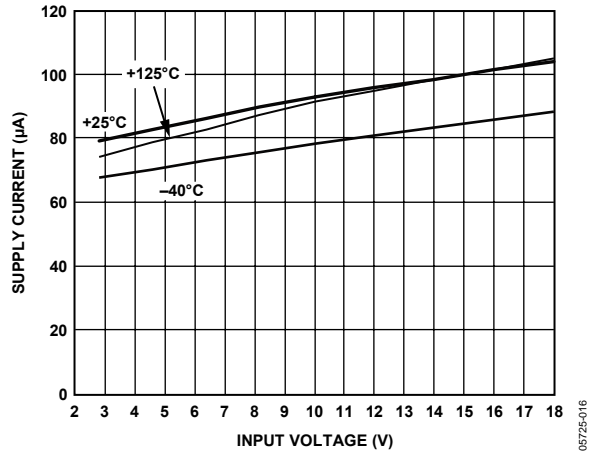

Figure 12. ADR121 Supply Current vs. Input Voltage

05725-016

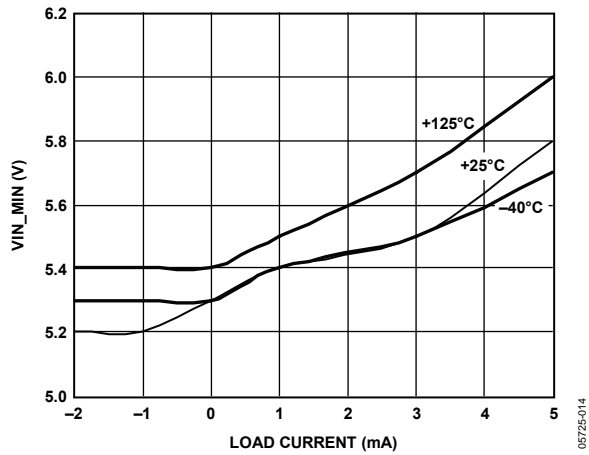

Figure 10. ADR125 Minimum Input Voltage vs. Load Current

05725-014

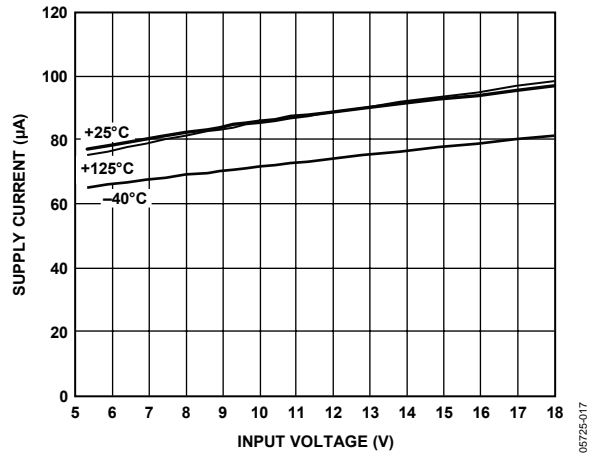

Figure 13. ADR125 Supply Current vs. Input Voltage

05725-017

# ADR121/ADR125/ADR127

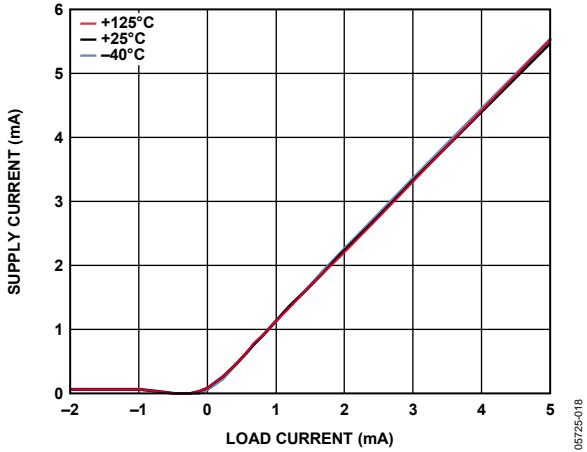

Figure 14. ADR127 Supply Current vs. Load Current

05725-018

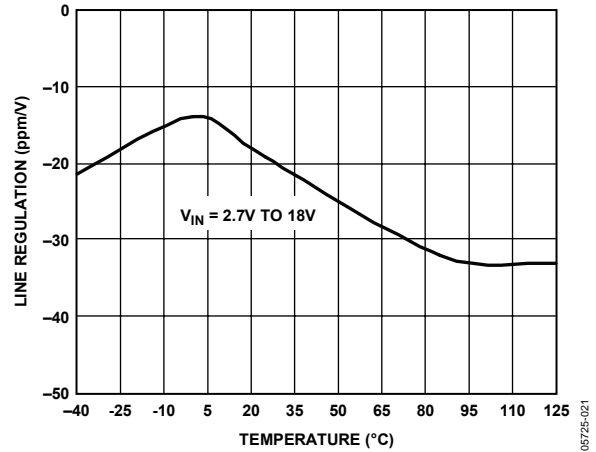

Figure 17. ADR127 Line Regulation vs. Temperature

05725-021

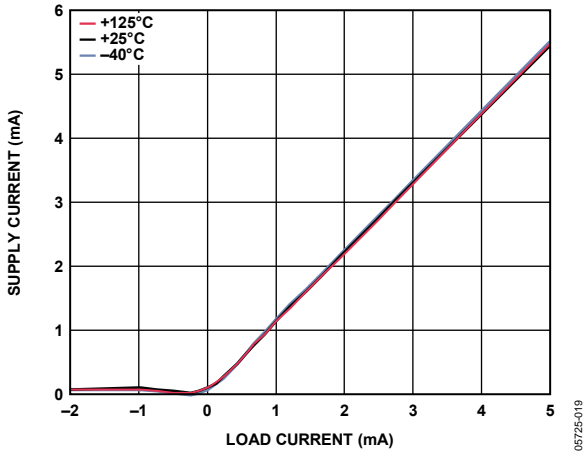

Figure 15. ADR121 Supply Current vs. Load Current

05725-019

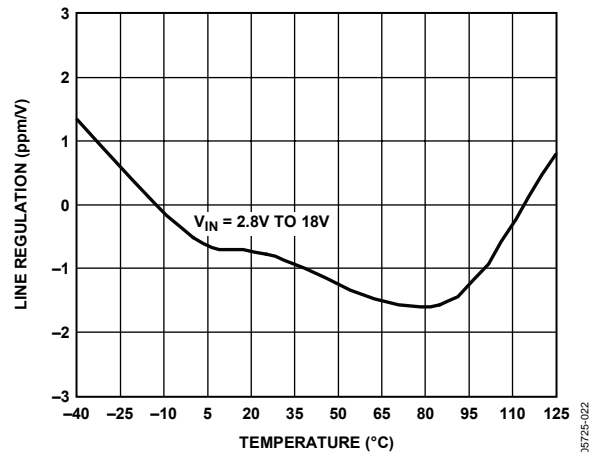

Figure 18. ADR121 Line Regulation vs. Temperature

05725-022

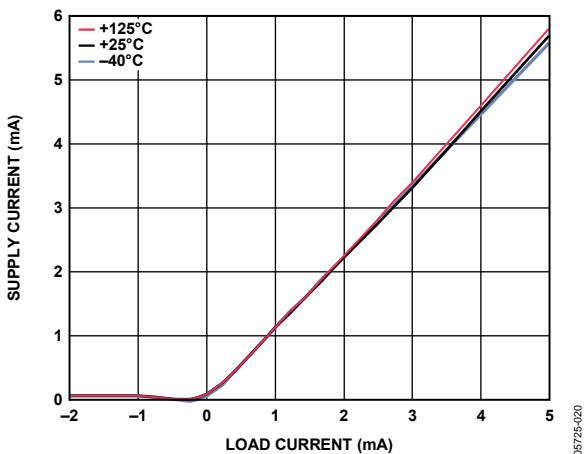

Figure 16. ADR125 Supply Current vs. Load Current

05725-020

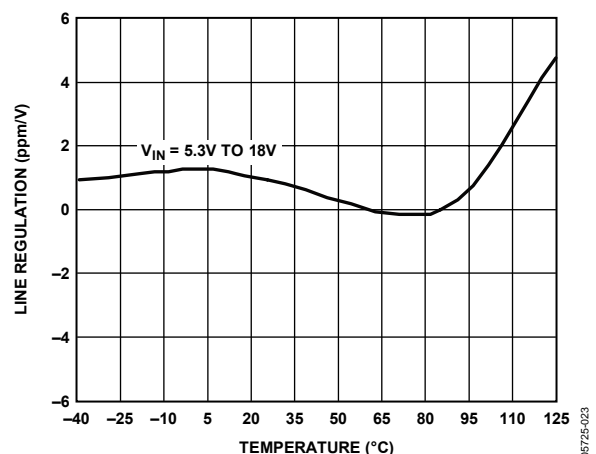

Figure 19. ADR125 Line Regulation vs. Temperature

05725-023

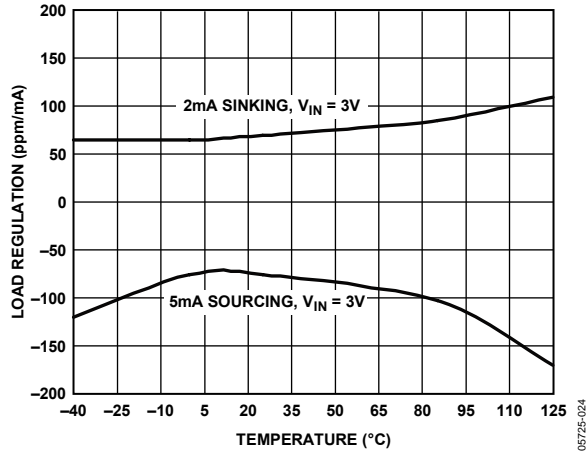

Figure 20. ADR127 Load Regulation vs. Temperature

05725-024

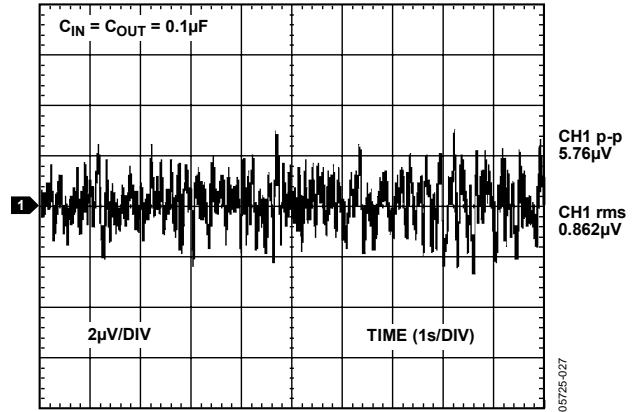

Figure 23. ADR127 0.1 Hz to 10 Hz Noise

05725-027

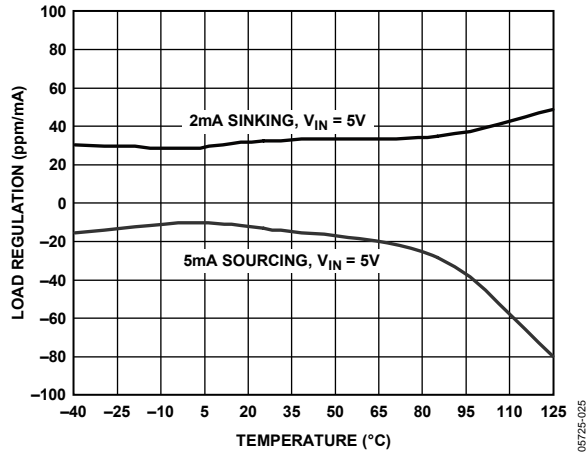

Figure 21. ADR121 Load Regulation vs. Temperature

05725-025

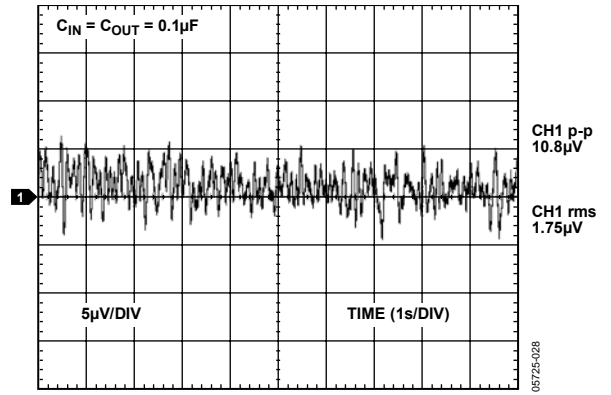

Figure 24. ADR121 0.1 Hz to 10 Hz Noise

05725-028

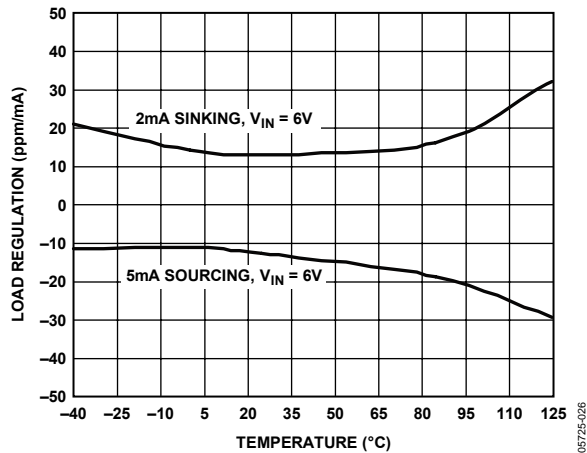

Figure 22. ADR125 Load Regulation vs. Temperature

05725-026

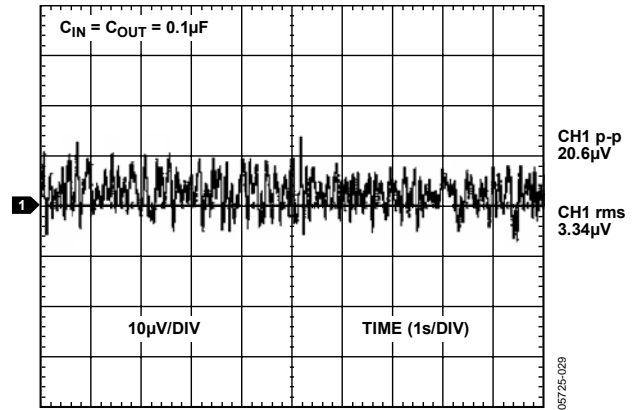

Figure 25. ADR125 0.1 Hz to 10 Hz Noise

05725-029

# ADR121/ADR125/ADR127

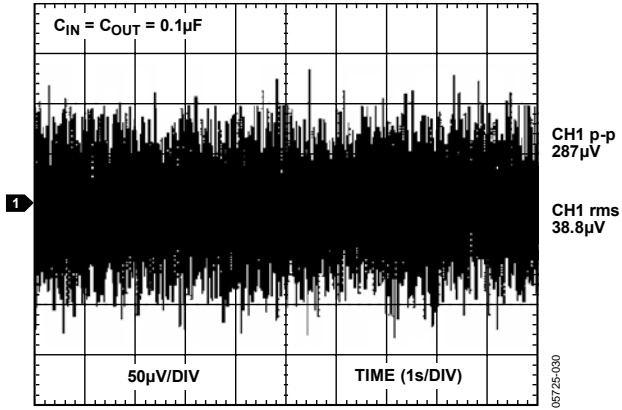

Figure 26. ADR127 10 Hz to 10 KHz Noise

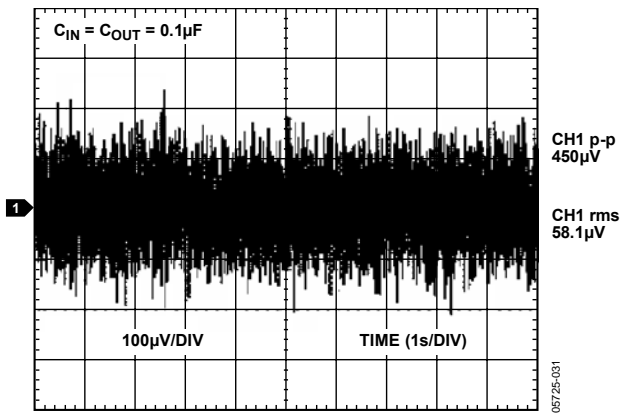

Figure 27. ADR121 10 Hz to 10 KHz Noise

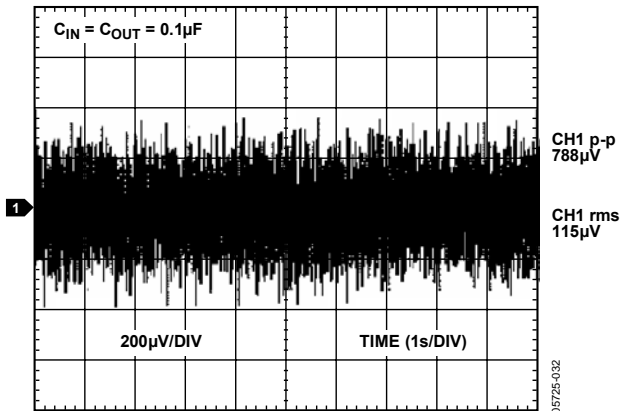

Figure 28. ADR125 10 Hz to 10 KHz Noise

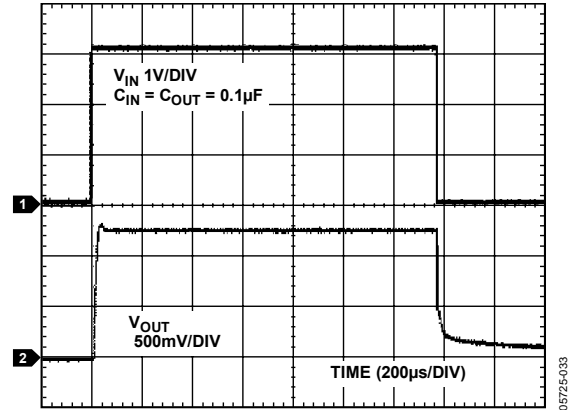

Figure 29. ADR127 Turn-On Response

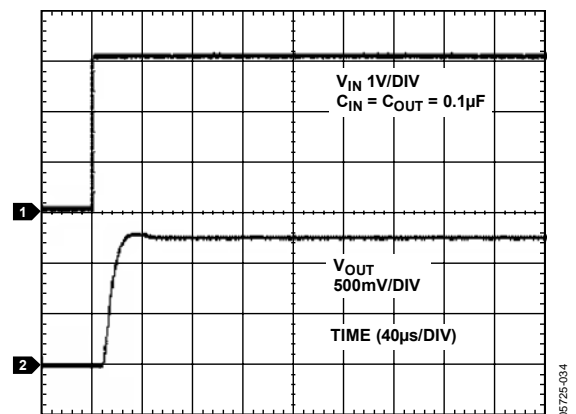

Figure 30. ADR127 Turn-On Response

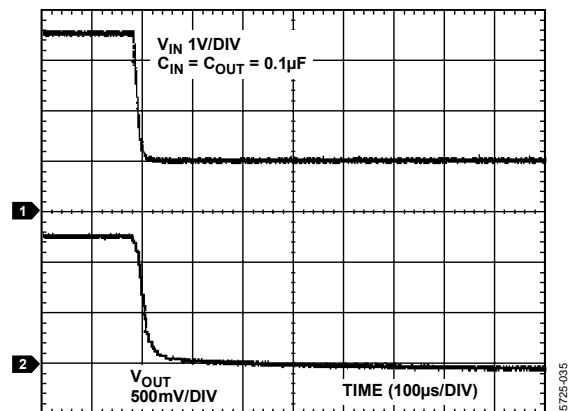

Figure 31. ADR127 Turn-Off Response

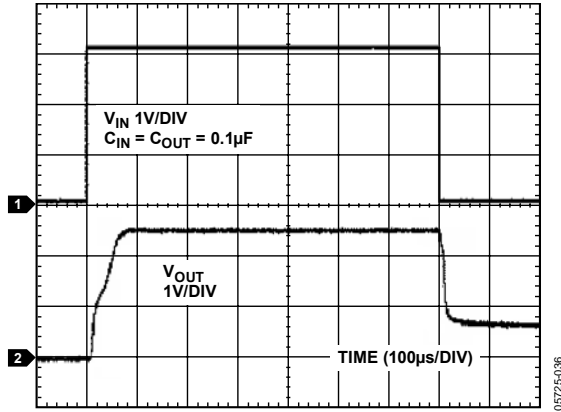

Figure 32. ADR121 Turn-On Response

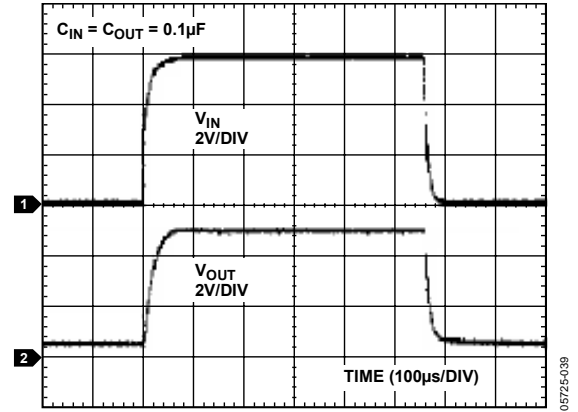

Figure 35. ADR125 Turn-On Response

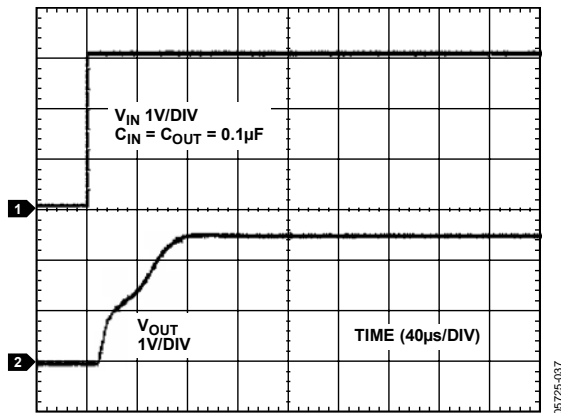

Figure 33. ADR121 Turn-On Response

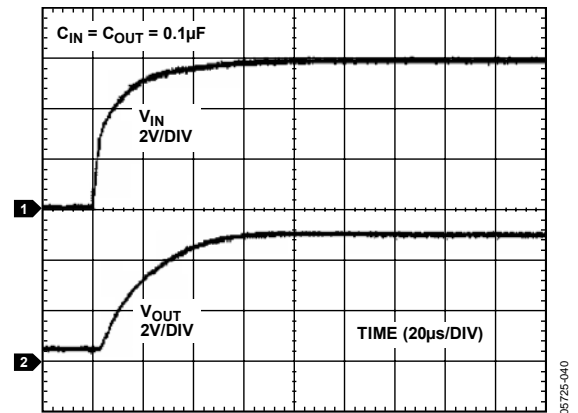

Figure 36. ADR125 Turn-On Response

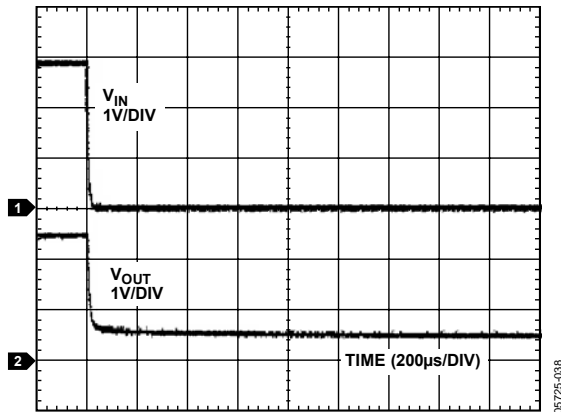

Figure 34. ADR121 Turn-Off Response

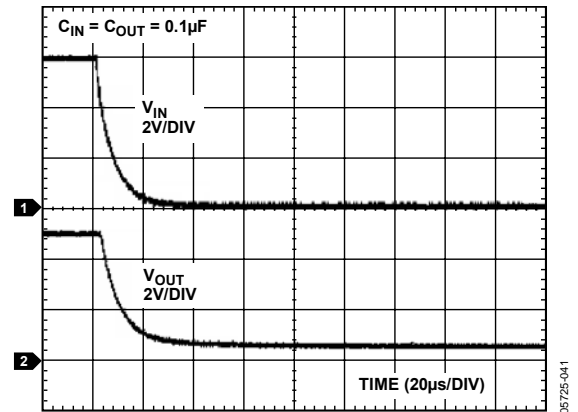

Figure 37. ADR125 Turn-Off Response

05725-036

05725-039

05725-037

05725-040

05725-038

05725-041

# ADR121/ADR125/ADR127

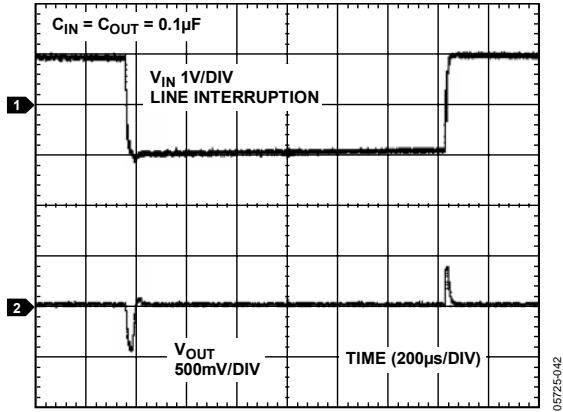

Figure 38. ADR127 Line Transient Response

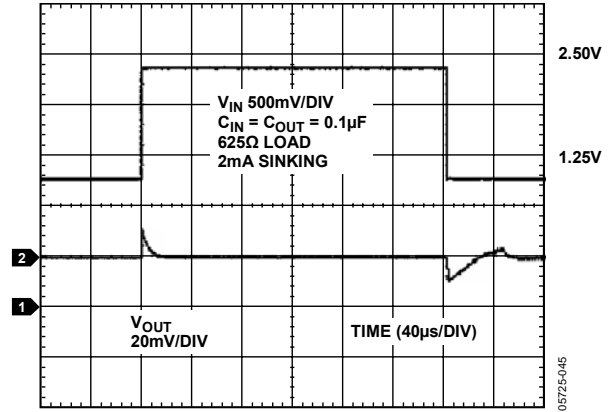

Figure 41. ADR127 Load Transient Response (Sinking)

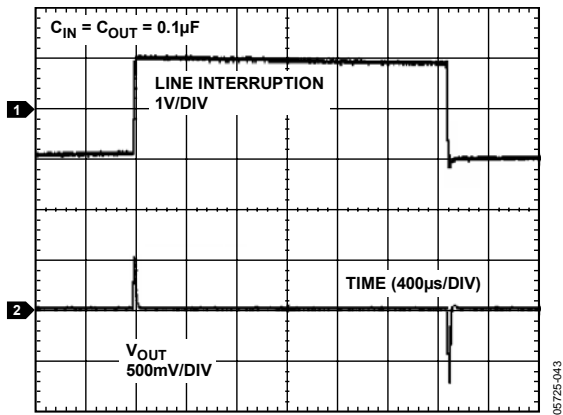

Figure 39. ADR121 Line Transient Response

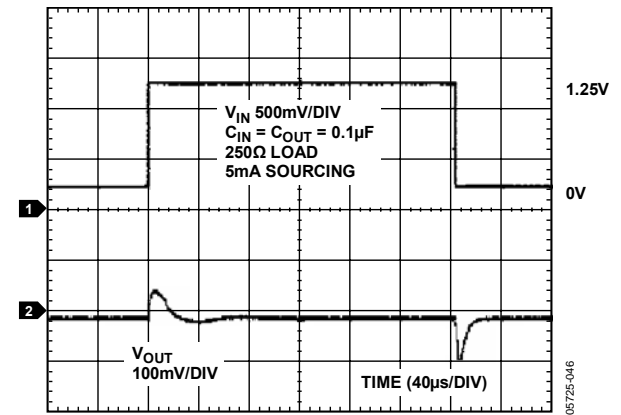

Figure 42. ADR127 Load Transient Response (Sourcing)

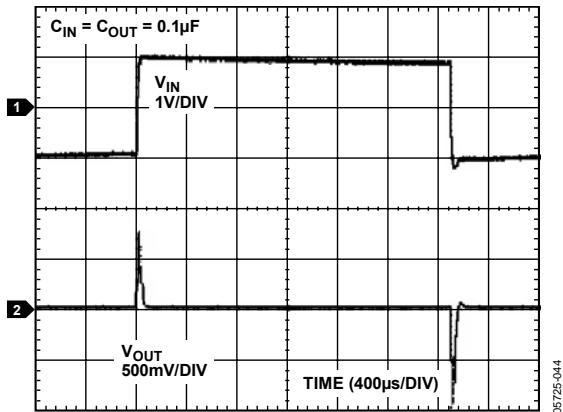

Figure 40. ADR125 Line Transient Response

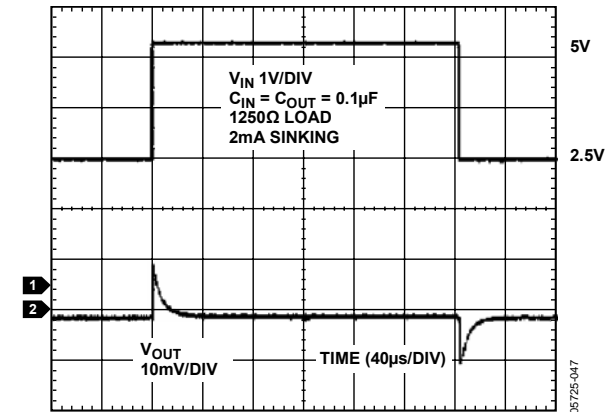

Figure 43. ADR121 Load Transient Response (Sinking)

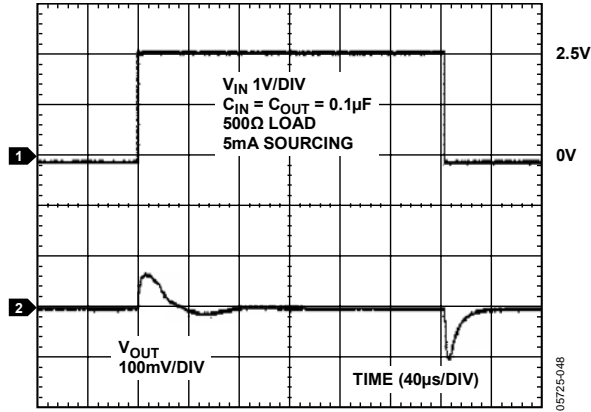

Figure 44. ADR121 Load Transient Response (Sourcing)

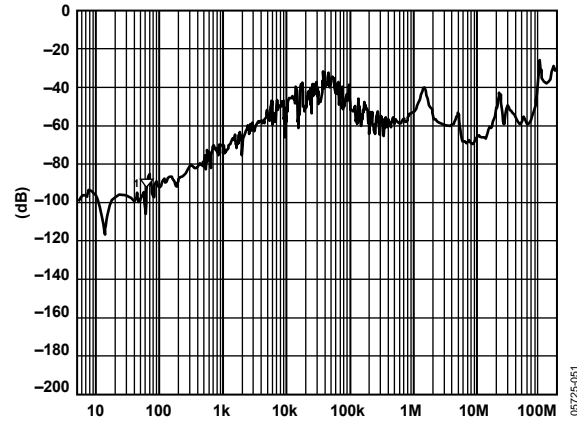

Figure 47. ADR121/ADR125/ADR127 PSRR

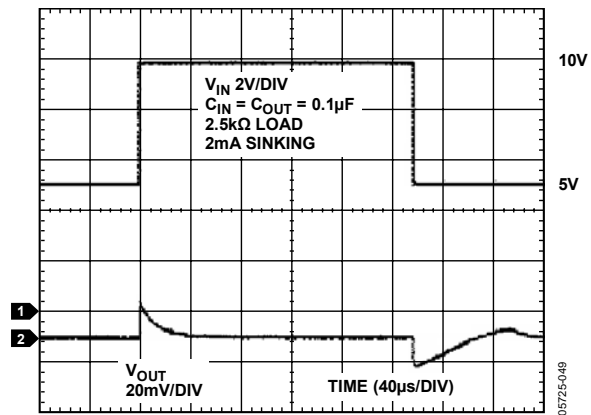

Figure 45. ADR125 Load Transient Response (Sinking)

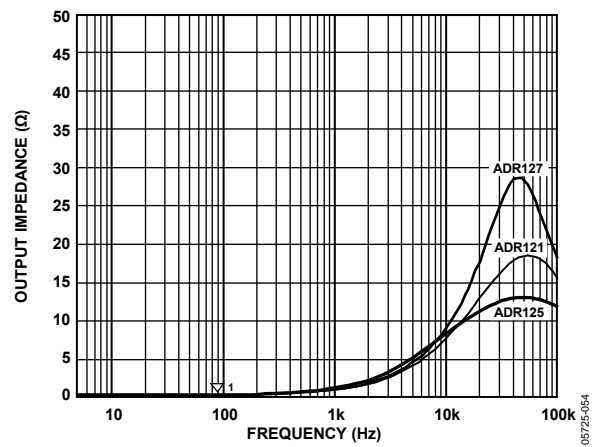

Figure 48. ADR121/ADR125/ADR127 Output Impedance vs. Frequency

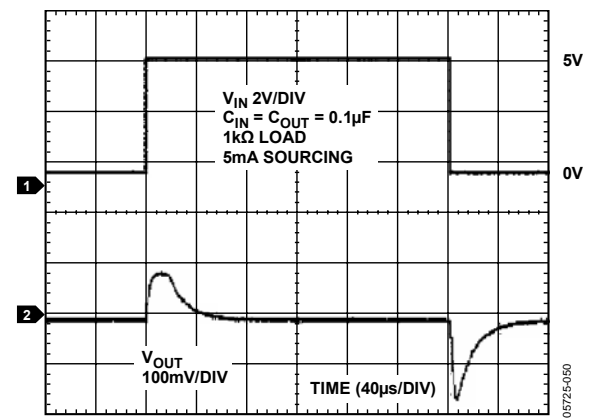

Figure 46. ADR125 Load Transient Response (Sourcing)

## THEORY OF OPERATION

The ADR12x band gap references are the high performance solution for low supply voltage and low power applications. The uniqueness of these products lies in their architecture.

### POWER DISSIPATION CONSIDERATIONS

The ADR12x family is capable of delivering load currents to 5 mA with an input range from 3.0 V to 18 V. When this device is used in applications with large input voltages, care must be taken to avoid exceeding the specified maximum power dissipation or junction temperature, because this could result in premature device failure.

Use the following formula to calculate a device's maximum junction temperature or dissipation:

$$P_D = \frac{T_J - T_A}{\theta_{JA}}$$

where:

$T_J$  is the junction temperature.

$T_A$  is the ambient temperature.

$P_D$  is the device power dissipation.

$\theta_{JA}$  is the device package thermal resistance.

## NOTES

### Input Capacitor

Input capacitors are not required on the ADR12x. There is no limit for the value of the capacitor used on the input, but a 1  $\mu\text{F}$  to 10  $\mu\text{F}$  capacitor on the input improved transient response in the applications where there is a sudden supply change. An additional 0.1  $\mu\text{F}$  capacitor in parallel also helps reduce noise from the supply.

### Output Capacitor

The ADR12x requires a small 0.1  $\mu\text{F}$  capacitor for stability. Additional 0.1  $\mu\text{F}$  to 10  $\mu\text{F}$  capacitance in parallel can improve load transient response. This acts as a source of stored energy for a sudden increase in load current. The only parameter affected with the additional capacitance is turn-on time.



## APPLICATIONS

### BASIC VOLTAGE REFERENCE CONNECTION

The circuit in Figure 4 illustrates the basic configuration for the ADR12x family voltage reference.

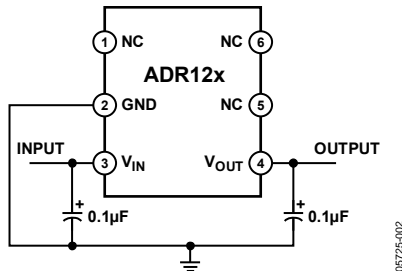

Figure 49. Basic Configuration for the ADR12x Family

### STACKING REFERENCE ICs FOR ARBITRARY OUTPUTS

Some applications may require two reference voltage sources that are a combined sum of the standard outputs. Figure 50 shows how this stacked output reference can be implemented.

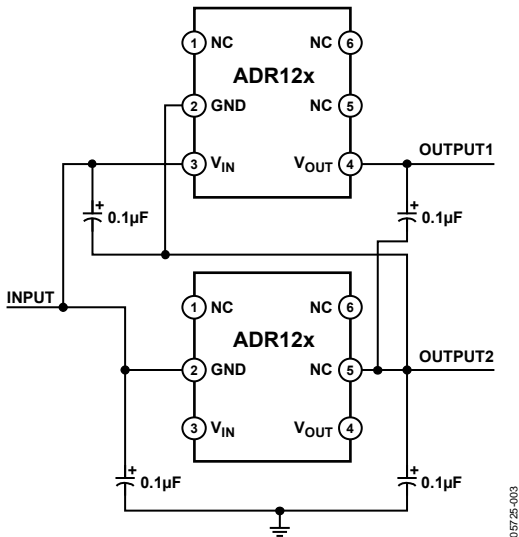

Figure 50. Stacking References with ADR12x

Two reference ICs are used and fed from an unregulated input,  $V_{IN}$ . The outputs of the individual ICs are connected in series, which provide two output voltages,  $V_{OUT1}$  and  $V_{OUT2}$ .  $V_{OUT1}$  is the terminal voltage of U1, while  $V_{OUT2}$  is the sum of this voltage and the terminal of U2. U1 and U2 are chosen for the two voltages that supply the required outputs (see Table 6). For example, if U1 and U2 are ADR127 and  $V_{IN} \geq 3.95$  V,  $V_{OUT1}$  is 1.25 V and  $V_{OUT2}$  is 2.5 V.

Table 6. Required Outputs

U1/U2	$V_{OUT2}$	$V_{OUT1}$
ADR127/ADR121	1.25 V	3.75 V
ADR127/ADR125	1.25 V	6.25 V
ADR121/ADR125	2.5 V	7.5 V

### NEGATIVE PRECISION REFERENCE WITHOUT PRECISION RESISTORS

A negative reference is easily generated by adding an op amp, A1, and is configured as shown in Figure 51.  $V_{OUT1}$  is at virtual ground and, therefore, the negative reference can be taken directly from the output of the op amp. The op amp must be dual-supply, low offset, and rail-to-rail if the negative supply voltage is close to the reference output.

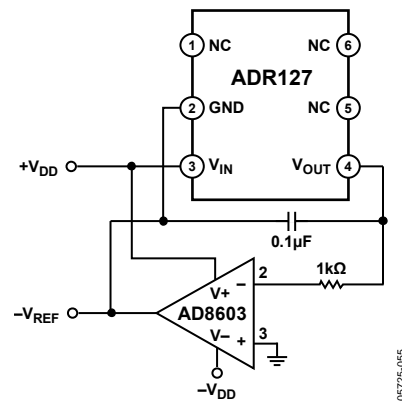

Figure 51. Negative Reference

### GENERAL-PURPOSE CURRENT SOURCE

In low power applications, the need can arise for a precision current source that can operate on low supply voltages. The ADR12x can be configured as a precision current source (see Figure 52). The circuit configuration shown is a floating current source with a grounded load. The reference's output voltage is bootstrapped across  $R_{SET}$ , which sets the output current into the load. With this configuration, circuit precision is maintained for load currents ranging from the reference's supply current, typically 85  $\mu$ A, to approximately 5 mA.

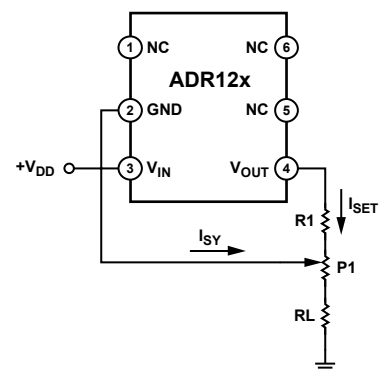
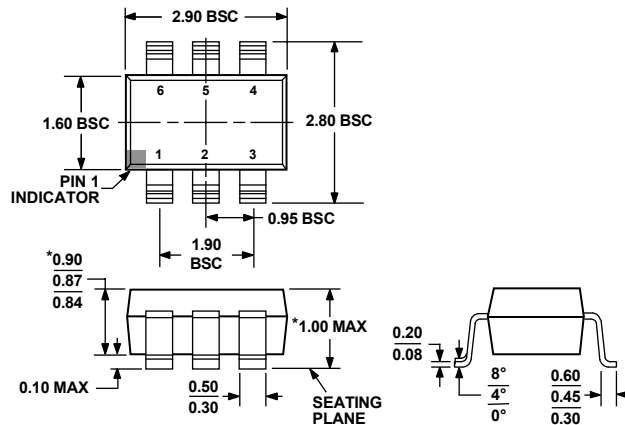

Figure 52. ADR12x Trim Configuration

# ADR121/ADR125/ADR127

## OUTLINE DIMENSIONS



\*COMPLIANT TO JEDEC STANDARDS MO-193-AA WITH THE EXCEPTION OF PACKAGE HEIGHT AND THICKNESS.

Figure 53. 6-Lead Thin Small Outline Transistor Package [TSOT] (UJ-6)

Dimensions shown in millimeters

## ORDERING GUIDE

Model	Output Voltage (Vo)	Initial Accuracy (mV/%)		Temperature Coefficient (ppm/°C)	Package Description	Package Option	Temperature Range (°C)	Ordering Quantity	Branding
ADR121AUJZ-REEL7 <sup>1</sup>	2.5	2.5	0.24	25	6-Lead TSOT	UJ-6	-40°C to +125°C	3000	RON
ADR121AUJZ-R2 <sup>1</sup>	2.5	2.5	0.24	25	6-Lead TSOT	UJ-6	-40°C to +125°C	250	RON
ADR121BUJZ-REEL7 <sup>1</sup>	2.5	2.5	0.12	9	6-Lead TSOT	UJ-6	-40°C to +125°C	3000	ROP
ADR125AUJZ-REEL7 <sup>1</sup>	5.0	5.0	0.24	25	6-Lead TSOT	UJ-6	-40°C to +125°C	3000	ROQ
ADR125AUJZ-R2 <sup>1</sup>	5.0	5.0	0.24	25	6-Lead TSOT	UJ-6	-40°C to +125°C	250	ROQ
ADR125BUJZ-REEL7 <sup>1</sup>	5.0	5.0	0.12	9	6-Lead TSOT	UJ-6	-40°C to +125°C	3000	ROR
ADR127AUJZ-REEL7 <sup>1</sup>	1.25	3	0.24	25	6-Lead TSOT	UJ-6	-40°C to +125°C	3000	ROS
ADR127AUJZ-R2 <sup>1</sup>	1.25	3	0.24	25	6-Lead TSOT	UJ-6	-40°C to +125°C	250	ROS
ADR127BUJZ-REEL7 <sup>1</sup>	1.25	1.5	0.12	9	6-Lead TSOT	UJ-6	-40°C to +125°C	3000	ROT

<sup>1</sup> Z = Pb-free part.

**NOTES**

**NOTES**

Компания «Океан Электроники» предлагает заключение долгосрочных отношений при поставках импортных электронных компонентов на взаимовыгодных условиях!

Наши преимущества:

- Поставка оригинальных импортных электронных компонентов напрямую с производств Америки, Европы и Азии, а так же с крупнейших складов мира;
- Широкая линейка поставок активных и пассивных импортных электронных компонентов (более 30 млн. наименований);
- Поставка сложных, дефицитных, либо снятых с производства позиций;
- Оперативные сроки поставки под заказ (от 5 рабочих дней);
- Экспресс доставка в любую точку России;
- Помощь Конструкторского Отдела и консультации квалифицированных инженеров;
- Техническая поддержка проекта, помощь в подборе аналогов, поставка прототипов;
- Поставка электронных компонентов под контролем ВП;
- Система менеджмента качества сертифицирована по Международному стандарту ISO 9001;
- При необходимости вся продукция военного и аэрокосмического назначения проходит испытания и сертификацию в лаборатории (по согласованию с заказчиком);
- Поставка специализированных компонентов военного и аэрокосмического уровня качества (Xilinx, Altera, Analog Devices, Intersil, Interpoint, Microsemi, Actel, Aeroflex, Peregrine, VPT, Syfer, Eurofarad, Texas Instruments, MS Kennedy, Miteq, Cobham, E2V, MA-COM, Hittite, Mini-Circuits, General Dynamics и др.);

Компания «Океан Электроники» является официальным дистрибьютором и эксклюзивным представителем в России одного из крупнейших производителей разъемов военного и аэрокосмического назначения «JONHON», а так же официальным дистрибьютором и эксклюзивным представителем в России производителя высокотехнологичных и надежных решений для передачи СВЧ сигналов «FORSTAR».



## JONHON

«JONHON» (основан в 1970 г.)

Разъемы специального, военного и аэрокосмического назначения:

(Применяются в военной, авиационной, аэрокосмической, морской, железнодорожной, горно- и нефтедобывающей отраслях промышленности)

«FORSTAR» (основан в 1998 г.)

ВЧ соединители, коаксиальные кабели, кабельные сборки и микроволновые компоненты:

(Применяются в телекоммуникациях гражданского и специального назначения, в средствах связи, РЛС, а так же военной, авиационной и аэрокосмической отраслях промышленности).



Телефон: 8 (812) 309-75-97 (многоканальный)

Факс: 8 (812) 320-03-32

Электронная почта: [ocean@oceanchips.ru](mailto:ocean@oceanchips.ru)

Web: <http://oceanchips.ru/>

Адрес: 198099, г. Санкт-Петербург, ул. Калинина, д. 2, корп. 4, лит. А