



MAX9268 Evaluation Kit

Evaluates: MAX9268

General Description

The MAX9268 evaluation kit (EV kit) provides a proven design to evaluate the MAX9268 gigabit multimedia serial link (GMSL) with spread spectrum and full-duplex control channel. The EV kit also includes Windows XP®, Windows Vista®, and Windows® 7-compatible software that provides a simple graphical user interface (GUI) for exercising the features of the MAX9268.

The MAX9268 EV kit comes with a MAX9268GCM/V+ installed.

For complete GMSL evaluation, order both the MAX9268 EV kit and its companion board, the MAX9249 EV kit or the MAX9259 EV kit.

Features

- ◆ Drives LVDS Video and I²S Audio
- ◆ On-Board I²S Audio DAC (MAX9850)
- ◆ On-Board Class D Audio Power Amplifier (MAX9701)
- ◆ Windows XP-, Windows Vista-, and Windows 7-Compatible Software
- ◆ USB-PC Connection (Cable Included)
- ◆ USB Powered
- ◆ Proven PCB Layout
- ◆ Fully Assembled and Tested

Ordering Information

PART	TYPE
MAX9268EVKIT+	EV Kit

+Denotes lead(Pb)-free and RoHS compliant.

Note: The MAX9268 EV kit should be ordered with its companion board, the MAX9249 EV kit or the MAX9259 EV kit.

Component List

DESIGNATION	QTY	DESCRIPTION
C1–C7	7	0.01μF ±10%, 25V X7R ceramic capacitors (0402) Murata GRM155R71E103K
C8–C14, C101–C105, C121, C131, C141, C151, C257, C258, C259, C291–C294	23	0.1μF ±10%, 16V X7R ceramic capacitors (0603) Murata GRM188R71C104K
C19, C20	2	0.22μF ±10%, 50V X7R ceramic capacitors (0805) Murata GRM21BR71H224K
C21	1	4.7μF ±20%, 25V X7R ceramic capacitor (1206) Murata GCM31CR71E475M
C22, C24, C25, C26, C109	5	10μF ±20%, 16V X5R ceramic capacitors (1206) Murata GRM31CR61C106M
C23	0	Not installed, capacitor (1206)

DESIGNATION	QTY	DESCRIPTION
C106, C107, C122, C123	4	22pF ±5%, 50V C0G ceramic capacitors (0603) TDK C1608C0G1H220J
C108	1	1μF ±10%, 16V X5R ceramic capacitor (0603) TDK C1608X5R1C105K
C110	1	0.033μF ±10%, 25V X7R ceramic capacitor (0603) Murata GRM188R71E333K
C111	0	Not installed, capacitor (0603)
C200, C203–C209, C216, C217	10	1μF ±10%, 6.3V X5R ceramic capacitors (0402) Murata GRM155R60J105K
C201	1	2.2μF ±20%, 6.3V X5R ceramic capacitor (0603) TDK C1608X5R0J225M
C202	1	0.47μF ±20%, 16V X7R ceramic capacitor (0603) TDK C1608X7R1C474M

Windows is a registered trademark of Microsoft Corp.



Maxim Integrated Products 1

For pricing, delivery, and ordering information, please contact Maxim Direct at 1-888-629-4642, or visit Maxim's website at www.maxim-ic.com.

MAX9268 Evaluation Kit

Evaluates: MAX9268

Component List (continued)

DESIGNATION	QTY	DESCRIPTION
C210, C211	2	220 μ F \pm 20%, 6.3V low-ESR tantalum capacitors (C case) AVX TPSC227M006R0070
C212, C213	0	Not installed, capacitors (C case)
C214, C215	2	10 μ F \pm 20%, 6.3V X5R ceramic capacitors (0805) TDK C2012X5R0J106M
C250	1	100pF \pm 5%, 50V C0G ceramic capacitor (0603) TDK C1608C0G1H101J
C251–C254	4	1 μ F \pm 10%, 6.3V X5R ceramic capacitors (0603) TDK C1608X5R0J105K
C255	0	Not installed, capacitor (0805)
C256	1	10 μ F \pm 10%, 6.3V X5R ceramic capacitor (0805) Murata GRM21BR60J106K
H1	1	10-pin header (2 x 5)
H20	1	8-pin header
J1	1	High-speed automotive connector Rosenberger D4S20F-40MA5-Z
J10	1	USB type-B, right-angle female receptacle
J201–J204	4	Phono jacks
J206	1	3.5mm stereo headphone jack
JU1–JU6, JU9, JU11, JU121, JU151, JU152, JU252, JU253, JU254, JU206, JU290–JU293, SW1	20	3-pin headers
JU7, JU8	2	4-pin headers
JU10, JU21, JU22, JU23, JU153, JU154, JU191–JU194, JU202–JU205, JUCNTL0, JUCNTL1, JUCNTL2	17	2-pin headers

DESIGNATION	QTY	DESCRIPTION
JU101–JU108, JU141–JU144, JU255, JU256, JU294	0	Not installed, 2-pin headers—shorted with PCB trace
JU201	1	6-pin header (2 x 3)
JU251	1	5-pin header
L21, L22, L23, L101	4	Ferrite beads (0603) TDK MMZ1608R301A
L251–L255	5	100 Ω , 3A ferrite beads (0603) TDK MPZ1608S101A
LED1, LED3, LED4, LED120, LED151–LED158	12	Red LEDs (0805)
LED2	1	Green LED (0805)
Q1–Q5	5	n-channel MOSFETs (SOT23 Central Semi 2N7002
R1, R2	2	49.9k Ω \pm 1% resistors (0603)
R3–R8	6	2.2k Ω \pm 5% resistors (0603)
R11–R15, R123, R151–R158, R201, R202	16	1k Ω \pm 5% resistors (0603)
R101, R102	2	27 Ω \pm 5% resistors (0603)
R103	1	1.5k Ω \pm 5% resistor (0603)
R104	1	470 Ω \pm 5% resistor (0603)
R111, R112	0	Not installed, resistors (0603)
R121	1	1.1k Ω \pm 5% resistor (0603)
R122	1	10k Ω \pm 5% resistor (0603)
R191, R192	2	4.7k Ω \pm 5% resistors (0603)
R251	1	49.9 Ω \pm 1% resistor (0603)
RT100–RT104	0	Not installed, 100 Ω \pm 5% resistors (0402)
SW122, SW150–SW157	9	Momentary pushbutton switches (6mm)
U1	1	Gigabit multimedia serial link, LVDS outputs (48 TQFP-EP*) Maxim MAX9268GCM/V+
U2	1	3.3V, 500mA LDO regulator (8 μ MAX [®] -EP*) Maxim MAX1792EUA33+ (Top Mark: AAAC)

MAX9268 Evaluation Kit

Evaluates: MAX9268

Component List (continued)

DESIGNATION	QTY	DESCRIPTION
U10	1	UART-to-USB converter (32 TQFP)
U11	0	Not installed, 93C46-type 3-wire EEPROM 16-bit architecture (8 SO)
U12	1	Ultra-high-speed microcontroller (44 TQFP) Maxim DS89C450-ENL+
U13	1	Three-state quad buffer (14 SO) Fairchild 74AC125SC
U14	1	Level translator (14 TSSOP) Maxim MAX3378EEUD+
U15	1	I ² C I/O expander (24 QSOP) Maxim MAX7324AEG+
U19	1	Dual bidirectional level translator (8 SOT23) Maxim MAX3373EEKA+ (Top Mark: AAKS)
U20	1	Stereo audio DAC with DirectDrive [®] headphone amplifier (28 TQFN-EP*) Maxim MAX9850ETI+

DESIGNATION	QTY	DESCRIPTION
U25	1	1.3W filterless, stereo Class D audio power amplifier (24 TQFN-EP*) Maxim MAX9701ETG+
U29	0	Not installed, multiple-output clock generator with dual PLLs and OTP (20 TQFN-EP*) Maxim MAX9471ETP4X+
Y10	1	6MHz crystal (HCM49) Hong Kong X'tals SSL60000N1HK188F0-0
Y12	1	14.7456MHz crystal (HCM49) Hong Kong X'tals SSM14745N1HK188F0-0
—	1	USB high-speed A-to-B cable, 6ft
—	1	Cable assembly (2m) MD Elektronik PT1482
—	37	Shunts
—	1	PCB: MAX9268 EVALUATION KIT+

*EP = Exposed pad.

Component Suppliers

SUPPLIER	PHONE	WEBSITE
AVX Corporation	843-946-0238	www.avxcorp.com
Central Semiconductor Corp.	631-435-1110	www.centrasemi.com
Fairchild Semiconductor	888-522-5372	www.fairchildsemi.com
Hong Kong X'tals Ltd.	852-35112388	www.hongkongcrystal.com
MD Elektronik GmbH	011-49-86-38-604-0	www.md-elektronik-gmbh.de
Murata Electronics North America, Inc.	770-436-1300	www.murata-northamerica.com
Rosenberger Hochfrequenztechnik GmbH	011-49-86 84-18-0	www.rosenberger.de
TDK Corp.	847-803-6100	www.component.tdk.com

Note: Indicate that you are using the MAX9268 when contacting these component suppliers.

μMAX and DirectDrive are registered trademarks of Maxim Integrated Products, Inc.

MAX9268 Evaluation Kit

MAX9268 EV Kit Files

FILE	DESCRIPTION
INSTALL.EXE	Installs the EV kit files on your computer
MAX9268.EXE	Application program
CDM20600.EXE	Installs the USB device driver
UNINSTALL.EXE	Uninstalls the EV kit software
USB_Driver_Help_200.PDF	USB driver installation help file

Quick Start

Required Equipment

- MAX9268 EV kit (USB cable included)
- MAX9249 EV kit (USB cable included)
- 2m Rosenberger cable assembly (included in the MAX9268 EV kit)
- Data source (such as digital video)
- Optional: I²S or S/PDIF audio source
- Optional: Pair of 8Ω speakers
- Optional: 3.5mm stereo headphones (16Ω or greater)
- User-supplied PC with a spare USB port (direct 500mA connection required; do not use a hub)

Note: In the following sections, software-related items are identified by bolding. Text in **bold** refers to items directly from the EV kit software. Text in **bold and underlined** refers to items from the Windows operating system.

Procedure

The MAX9268 EV kit is fully assembled and tested. Follow the steps below to verify board operation:

- 1) Visit www.maxim-ic.com/evkitsoftware to download the latest version of the EV kit software, 9268Rxx. ZIP. Save the EV kit software to a temporary folder and uncompress the ZIP file.
- 2) Install the EV kit software and USB driver on your computer by running the INSTALL.EXE program inside the temporary folder. The program files are copied to your PC and icons are created in the Windows **Start | Programs** menu. During software installation, some versions of Windows may show a warning message indicating that this software is from an unknown publisher. This is not an error condition and it is safe to proceed with installation. Administrator privileges are required to install the USB device driver on Windows.
- 3) Verify that all jumpers are in their default positions, as shown in Table 1.
- 4) Connect the Rosenberger cable from MAX9249 EV kit connector J1 to MAX9268 EV kit connector J1.
- 5) Connect the LVDS data source to header H1 of the MAX9249 EV kit.
- 6) *Optional Audio Demo:* Connect the S/PDIF audio source (e.g., DVD player digital output) to MAX9249 EV kit phono jack J21. Or, connect I²S audio source to header H1 and remove jumper JU210. Connect speakers to MAX9268 EV kit SPKR_L+/SPKR_L- and SPKR_R+/SPKR_R- oval pads, or plug headphones into J206 headphone jack.
- 7) Connect the USB cable from the PC to the EV kit board. A Windows message appears when connecting the EV kit board to the PC for the first time. Each version of Windows has a slightly different message. If you see a Windows message stating **ready to use** then proceed to the next step. Otherwise, open the USB_Driver_Help_200.PDF document in the Windows **Start | Programs** menu to verify the USB driver was installed successfully.
- 8) Verify that MAX9249 EV kit LED120 lights up, indicating that the microcontroller is powered and enabled.
- 9) Verify that MAX9268 EV kit LED120 lights up, indicating that the microcontroller is powered and enabled.
- 10) Verify that MAX9268 EV kit LED2 lights up, indicating that the link has been successfully established. If LED2 is off or LED1 is on, double-check that PCLK_IN signal is clocking data.
- 11) *Optional Audio Demo:* Press and release switch SW122 on both of the MAX9249 and MAX9268 EV kits to enable the S/PDIF-to-I²S and I²S-to-audio DAC demonstration circuitry. If I²S or S/PDIF audio was provided to the MAX9249 EV kit, audio should now be heard from the speakers or headphones previously connected to the MAX9268 EV kit.

MAX9268 Evaluation Kit

- 12) Start the MAX9249 EV kit software by opening its icon in the Windows **Start | Programs** menu. The EV kit software configuration window appears, as shown in Figure 7.
- 13) Press the **Connect** button and the configuration window disappears.
- 14) The EV kit software main window appears, as shown in Figure 1.
- 15) Press the **Read All** button to read all registers on the MAX9249 and MAX9268.
- 16) *I2C Slave Device Demo*: Make sure MAX9268 EV kit headers JU151–JU154 are in the 1-2 position.
- 17) In the software's **MAX7324** tab (Figure 4), press the **Search for MAX7324** button. Verify that the **MAX7324 Device Address** drop-down list shows **0xDA (JU151=1-2 JU152=1-2)**.
- 18) Press the **LED151-LED158 ON** button. Verify that MAX9268 EV kit LED151–LED158 turn on.
- 19) Press the **LEDs Alternating** button. Verify that MAX9268 EV kit LED151, LED153, LED156, and LED158 turn off.
- 20) *GPIO Demo*: In the software's **MAX9268** tab (Figure 3), scroll down to **Register 0x06**. Uncheck the **GPIO1OUT** checkbox and press the **Write** button. Verify that MAX9268 EV kit LED4 turns off.
- 21) Uncheck the **GPIO0OUT** checkbox and press the **Write** button. Verify that MAX9268 EV kit LED3 turns off.
- 22) Check the **GPIO1OUT** checkbox and press the **Write** button. Verify that MAX9268 EV kit LED4 turns on.
- 23) Check the **GPIO0OUT** checkbox and press the **Write** button. Verify that MAX9268 EV kit LED3 turns on.
- 24) *INT Demo*: Toggle MAX9268 EV kit switch SW2 up. Verify that MAX9249 EV kit LED1 turns on, indicating that MAX9268 INT input is asserted.
- 25) In the software's **MAX9268** tab, scroll to **Register 0x06** and press the **Read** button. Verify that the **INT** checkbox is checked, indicating that MAX9268 INT input is asserted.
- 26) Toggle MAX9268 EV kit switch SW2 down. Verify that MAX9249 EV kit LED1 turns off, indicating that MAX9268 INT input is not asserted.
- 27) In the software's **MAX9268** tab, scroll to **Register 0x06** and press the **Read** button. Verify that the **INT** checkbox is not checked, indicating that MAX9268 INT input is not asserted.

Detailed Description of Software

The main window of the evaluation software (Figure 1) shows a block diagram representing the MAX9249/MAX9268 system. The left column shows MAX9249 input data sources, and the right column shows MAX9268 output data sinks.

The **Change Configuration** button (Figure 1) brings up the **Configuration** window (Figure 7), allowing the software GUI to select into which side of the link the USB cable should be plugged. Controlling from the MAX9268 side requires changing some jumper settings as described in this window. If the MAX9249 and MAX9268 device addresses have been previously changed from their factory power-on-reset values, the new addresses must be specified in the **Configuration** window to allow register access.

The **Baud Rate** drop-down list sets the communications baud rate. The USB link uses the same baud rate as the MAX9249/MAX9268. Note that the baud rate should only be changed one step at a time.

The **Read All** button reads all the MAX9249 and MAX9268 device registers. **Reset to Default Values** restores recommended factory settings, and **Write All** writes all MAX9249/MAX9268 device registers with the values shown in the GUI.

The **MAX9249** tab sheet (Figure 2) provides direct access to all registers of the MAX9249, and the **MAX9268** tab sheet (Figure 3) provides direct access to all registers of the MAX9268. Each register has its own **Read** and **Write** button. The small circle next to the **Read** button turns yellow to indicate an attempt to read or write, red to indicate a failed read or write, and green to indicate a successful read or write operation.

The **MAX7324** tab sheet (Figure 4) controls the I²C I/O expander on the remote side of the link. When the USB is plugged into the MAX9249 EV kit, the **MAX7324** tab sheet controls the MAX7324 (U15) on the MAX9268 EV kit. Note that the MAX7324 actually has two device addresses; for simplicity, the software GUI only displays the device address associated with MAX7324 outputs. For details, refer to the MAX7324 IC data sheet.

The **PRBS Test** tab sheet (Figure 5) uses the MAX9268 registers to perform a pseudorandom bit sequence (PRBS) error-rate test. Select the test duration (maximum 32,767sec = 9.1hrs) and press the **Start** button. The software GUI configures the MAX9268 to begin the PRBS test, counts down the specified delay time, and then reports the final value of the MAX9268 PRBSERR register.

MAX9268 Evaluation Kit

The **Interface History and Low Level Access** tab sheet (Figure 6) shows the recent low-level communications activity between the software GUI and the MAX9249/MAX9268. The **Register Access** group box provides arbitrary device read/write control, supporting additional user-supplied devices besides the on-board MAX9249, MAX9268, and MAX7324. The **Device Address, Register, and Data** drop-down lists specify the device address and the register within the device, as well as one optional byte of data to be written. Pressing the **Write Register** button writes one byte of data to the specified device register. **Read Register** reads the specified device register and reports the results into the **Interface History** window. Devices that are not register-based (such as the MAX7324) are supported by **Send Data (no register)** and **Receive Data (no register)**. User-supplied devices requiring other interface protocols must use **Raw TX byte codes** to communicate. Note that in bypass mode, raw data is passed to the user-supplied slave device directly without modification.

Detailed Description of Hardware

The MAX9268 EV kit provides a proven layout for the MAX9268. On-board level translators, I²S stereo audio DAC, Class D audio power amplifier, and easy-to-use USB-PC connection are included on the EV kit.

The MAX9268 EV kit board layout is divided into four principal sections.

From header H1 to connector J1 are the support components specific to the MAX9268. On-board LDO regulator U2 powers the AVDD, DVDD, and IOVDD supplies from VIN. Jumper JU9 optionally connects VIN to the link cable, powering the remote EV kit board.

Below header H1, the board layout has three sections: microcontroller (U10–U14), I²C slave device (U15), and audio (U20–U25). The microcontroller and I²C slave device sections are identical to the MAX9249 and MAX9268 EV kits.

The audio section of the MAX9249 and MAX9259 EV kits contain S/PDIF-to-I²S audio converter circuits (U20–U25), which can be disabled by JU210 for applications already having I²S audio.

The audio section of the MAX9268 EV kit contains an I²S-to-audio DAC circuit (U20) and a Class D stereo power amplifier (U25). The audio DAC circuits are similar to the MAX9850 EV kit, and the power amplifier circuit is similar to the MAX9701 EV kit.

User-Supplied Interface

To use the MAX9268 EV kit with a user-supplied interface, first cut the PCB traces at jumpers JU141 and JU142. Next, apply your own TX/SCL signal at the U1 side of JU141 and RX/SDA at the U1 side of JU142. Refer to the MAX9249, MAX9259/MAX9260, and MAX9268 IC data sheets for details about UART protocol for base mode, write data format, read data format, selecting base mode or bypass mode, and selecting UART or I²C slave device.

User-Supplied Power Supply

The MAX9249 and MAX9268 EV kits are powered completely from the USB port by default. The 5V USB bus power is supplied to the remote EV kit over the link cable by default. Jumper JU10 powers the link cable (VBUS) from the 5V USB supply, and jumper JU9 connects the link cable VBUS to the VIN power supply.

To provide external power to each EV kit's VIN, and still power both microcontrollers from USB, remove the shunt from JU9, but leave the shunt at JU10 installed. The link cable carries the USB 5V bus power to the remote EV kit board, but external user-supplied VIN supplies are required to power the MAX9249 and the MAX9268.

To provide different power supplies to DVDD, AVDD, and IOVDD, remove the shunts from jumpers JU21, JU22, and JU23, and apply external user-supplied power at the DVDD, AVDD, and IOVDD oval pads.

The I²S audio link demonstration requires both MAX9249 EV kit and MAX9268 EV kit microcontrollers (U12) to be powered; otherwise, the on-board S/PDIF-to-I²S converter or the I²S audio DAC does not initialize.

Detailed Description of Firmware

The DS89C450 microcontroller (U12) runs custom firmware, which ensures that no breaks occur within register read/write commands. The firmware records 9-bit even-parity data received from the USB interface while RTS is set, and plays back the 9-bit data with 1.5 stop bits timing when RTS is cleared. Data received from the MAX9268 is relayed to USB immediately.

The audio chips are initialized by an I²C command sequence sent by the firmware when the microcontroller is reset. The same firmware runs on both the MAX9249 and MAX9268 EV kit boards, so this initialization sequence covers both the S/PDIF-to-I²S converter and the MAX9850 I²S stereo audio DAC. Pressing switch SW122 resets the microcontroller, resending the audio I²C initialization commands.

MAX9268 Evaluation Kit

Evaluates: MAX9268

The firmware also supports a small set of commands, available when RTS is clear. Since all register read/write requests are sent with RTS set, there is no conflict between register data and firmware commands. These firmware commands are issued automatically by the MAX9249 EV kit software GUI. The following information is provided for reference only.

Firmware command “?” prints the firmware version banner message and brief command list.

Firmware command “B” changes the baud rate by changing the internal TH1 baud-rate divisor. Refer to firmware help command “?” for details. Pressing switch SW122 resets the USB baud rate to 921,600 baud. The

software GUI automatically sends the baud-rate change command.

Firmware command “T” supports waking up the MAX9249 from the MAX9268 side of the link. Command “T” performs a dummy read, followed by a delay on the order of 1ms to 8ms, and finally writes a register value. For example, send “T810558800483” to read from device address 0x81 register 0x05, delay 4ms, then write to device address 0x80 register 0x04 data 0x83. This is the MAX9249 wake-up sequence for the default device addresses. The software GUI automatically sends this command when the **Wake Up MAX9249** button is pressed.

Table 1. MAX9268 EV Kit Jumper Descriptions

JUMPER	SIGNAL	SHUNT POSITION	DESCRIPTION
JU1	CDS	1-2	CDS = high; ECU attached to MAX9268; connects the USB to the MAX9268 EV kit
		2-3*	CDS = low; optional peripheral attached to the MAX9268
		Open	Reserved
SW1	MS	1-2 (toggle switch up)	MS = high; full-duplex bypass mode; device registers not accessible
		2-3* (toggle switch down)	MS = low; half-duplex base mode; required when writing to device registers or when using external I ² C peripheral
JU2	BWS	1-2*	BWS = high
		2-3	BWS = low
JU3	EQS	1-2*	EQS = high
		2-3	EQS = low
JU4	DRS	1-2*	DRS = high
		2-3	DRS = low
JU5	SSEN	1-2*	SSEN = high
		2-3	SSEN = low
JU6	$\overline{\text{PWDN}}$	1-2*	$\overline{\text{PWDN}}$ = high
		2-3	$\overline{\text{PWDN}}$ = low
JU7	ADD1	1-2	ADD1 = IOVDD (see Table 2)
		1-3	ADD1 = Open (see Table 2)
		1-4*	ADD1 = GND (see Table 2)
JU8	ADD0	1-2	ADD0 = IOVDD (see Table 2)
		1-3	ADD0 = Open (see Table 2)
		1-4*	ADD0 = GND (see Table 2)
JU9	Bus power	1-2*	J1 pin 4 connects to VIN
		2-3	J1 pin 4 connects to GND
		Open	J1 pin 4 unconnected
JU10	Bus power	1-2*	J1 pin 1 connects to USB+5V
		Open	USB power is not connected to link cable power

MAX9268 Evaluation Kit

Evaluates: MAX9268

Table 1. MAX9268 EV Kit Jumper Descriptions (continued)

JUMPER	SIGNAL	SHUNT POSITION	DESCRIPTION
JU11	INT	1-2	INT = high
		2-3	INT = low
JU21	AVDD	1-2*	AVDD power from 3.3V LDO U2, powered by VIN
		Open	AVDD must be provided from an external source
JU22	DVDD	1-2*	DVDD power from 3.3V LDO U2, powered by VIN
		Open	DVDD must be provided from an external source
JU23	IOVDD	1-2*	IOVDD power from 3.3V LDO U2, powered by VIN
		Open	IOVDD must be provided from an external source
JU121	Reserved	Not installed*	Reserved for factory diagnostic tests
JU141	TX/SCL	Not installed*	Connects U1–U12 through level translator U14
JU142	RX/SDA	Not installed*	Connects U1–U12 through level translator U14
JU143	LFLT	Not installed*	Connects U1 to the USB through level translator U14
JU144	INT	Not installed*	Connects U1 to the USB through level translator U14
JU151	U15 AD2	1-2*	Selects U15 I ² C device address
		2-3	Selects U15 I ² C device address
		Open	Reserved for factory diagnostic tests
JU152	U15 AD0	1-2*	Selects U15 I ² C device address
		2-3	Selects U15 I ² C device address
		Open	Reserved for factory diagnostic tests
JU153	U15 SDA	1-2*	Connects U15 MAX7324 to the I ² C bus; MS must be low (SW1) and CDS must be low (JU1 = 2-3 on both boards)
		Open	Disconnects U15 MAX7324 from the I ² C bus; MS can be high (SW1)
JU154	U15 SCL	1-2*	Connects U15 MAX7324 to the I ² C bus; MS must be low (SW1) and CDS must be low (JU1 = 2-3 on both boards)
		Open	Disconnects U15 MAX7324 from the I ² C bus; MS can be high (SW1)
JU191	AUDIO_SCL	1-2*	U12 sends I ² C initialization commands to audio chip U20
		Open	Disconnects the audio I ² C bus pullup resistor
JU192	AUDIO_SCL	1-2*	U12 sends the I ² C initialization commands to audio chip U20
		Open	Disconnects the audio I ² C bus
JU193	AUDIO_SDA	1-2*	U12 sends the I ² C initialization commands to audio chip U20
		Open	Disconnects the audio I ² C bus pullup resistor
JU194	AUDIO_SDA	1-2*	U12 sends the I ² C initialization commands to audio chip U20
		Open	Disconnects the audio I ² C bus
JU201	U20 ADD	1-2*	U20 ADD = GND Selects U20 device address 0010 000x (0x20) (on audio I ² C bus)
		3-4	U20 ADD = IOVDD Selects U20 device address 0010 001x (0x22) (on audio I ² C bus)
		5-6	U20 ADD = AUDIO_SDA Selects U20 device address 0010 011x (0x26) (on audio I ² C bus)
		Open	Reserved
JU202	HPS	1-2*	U20 MAX9850 headphone sense controlled by the insertion of headphones
		Open	U20 MAX9850 headphone sense switch forced open

MAX9268 Evaluation Kit

Evaluates: MAX9268

Table 1. MAX9268 EV Kit Jumper Descriptions (continued)

JUMPER	SIGNAL	SHUNT POSITION	DESCRIPTION
JU203	I2S SD	1-2*	U1 I2S audio drives U20 MAX9850 audio DAC
		Open	Disconnects the I2S signals
JU204	I2S SCK	1-2*	U1 I2S audio drives U20 MAX9850 audio DAC
		Open	Disconnects the I2S signals
JU205	I2S WS	1-2*	U1 I2S audio drives U20 MAX9850 audio DAC
		Open	Disconnects the I2S signals
JU206	MCLK	1-2*	U20 MCLK = PLL_OUT_MCLK from 4x PLL U29
		2-3	U20 MCLK = CNTL2/MCLK from U1
JU251	U25 SYNC	1-2*	U25 operates in spread-spectrum mode with $f_{OSC} = 1200\text{kHz} \pm 60\text{kHz}$
		1-3	U25 operates in fixed-frequency mode with $f_{OSC} = 1400\text{kHz}$
		1-4	U25 operates in fixed-frequency mode with $f_{OSC} = \text{external TTL-compatible clock frequency}$
		1-5	U25 operates in fixed-frequency mode with $f_{OSC} = 1100\text{kHz}$
		Open	Reserved
JU252	U25 $\overline{\text{SHDN}}$	1-2*	U25 $\overline{\text{SHDN}} = \text{high}$, enables speaker driver
		2-3	U25 $\overline{\text{SHDN}} = \text{low}$, disables speaker driver
		Open	Reserved
JU253	U25 GAIN2	1-2*	JU253 and JU254 set the gain of U25
		2-3	JU253 and JU254 set the gain of U25
		Open	Reserved
JU254	U25 GAIN1	1-2*	JU253 and JU254 set the gain of U25
		2-3	JU253 and JU254 set the gain of U25
		Open	Reserved
JU255	U25 INL-	Not installed*	U25 input INL is ground referenced
		Open	Reserved
JU256	U25 INR-	Not installed*	U25 input INR is ground referenced
		Open	Reserved

*Default position.

Table 2. Address-Select Jumpers (JU7, JU8)

JU7 SHUNT POSITION	ADD1	JU8 SHUNT POSITION	ADD0	MAX9268 ADDRESS
1-2	IOVDD	1-2	IOVDD	0xD4
		1-3	Open	0xD8
		1-4	GND	0xD0
1-3	Open	1-2	IOVDD	0x54
		1-3	Open	0x58
		1-4	GND	0x50
1-4*	GND	1-2	IOVDD	0x94
		1-3	Open	0x98
		1-4*	GND	0x90

*Device address is determined when power is applied.

MAX9268 Evaluation Kit

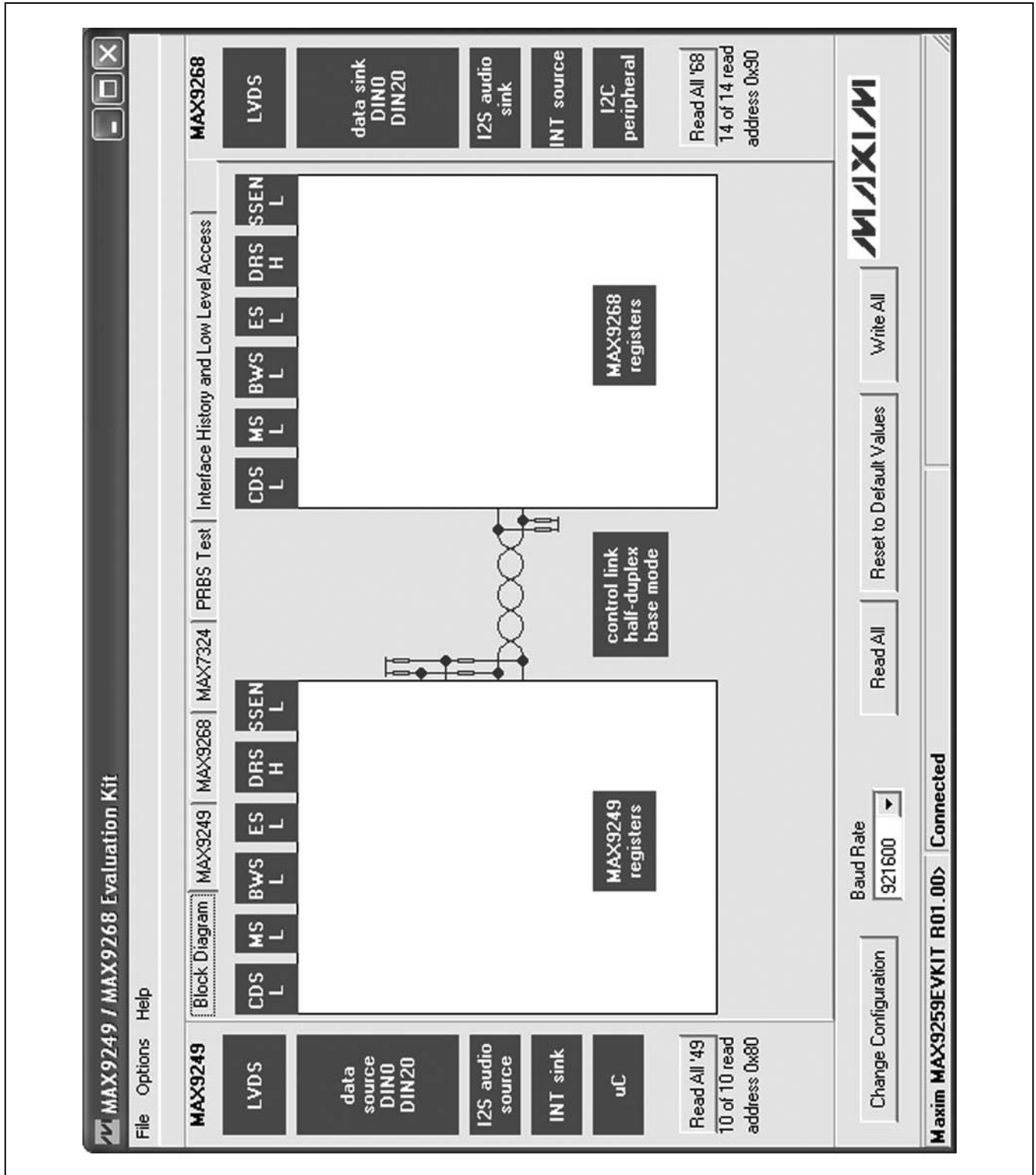

Figure 1. MAX9249/MAX9268 EV Kit Software Main Window (Block Diagram Tab)

MAX9268 Evaluation Kit

Evaluates: **MAX9268**

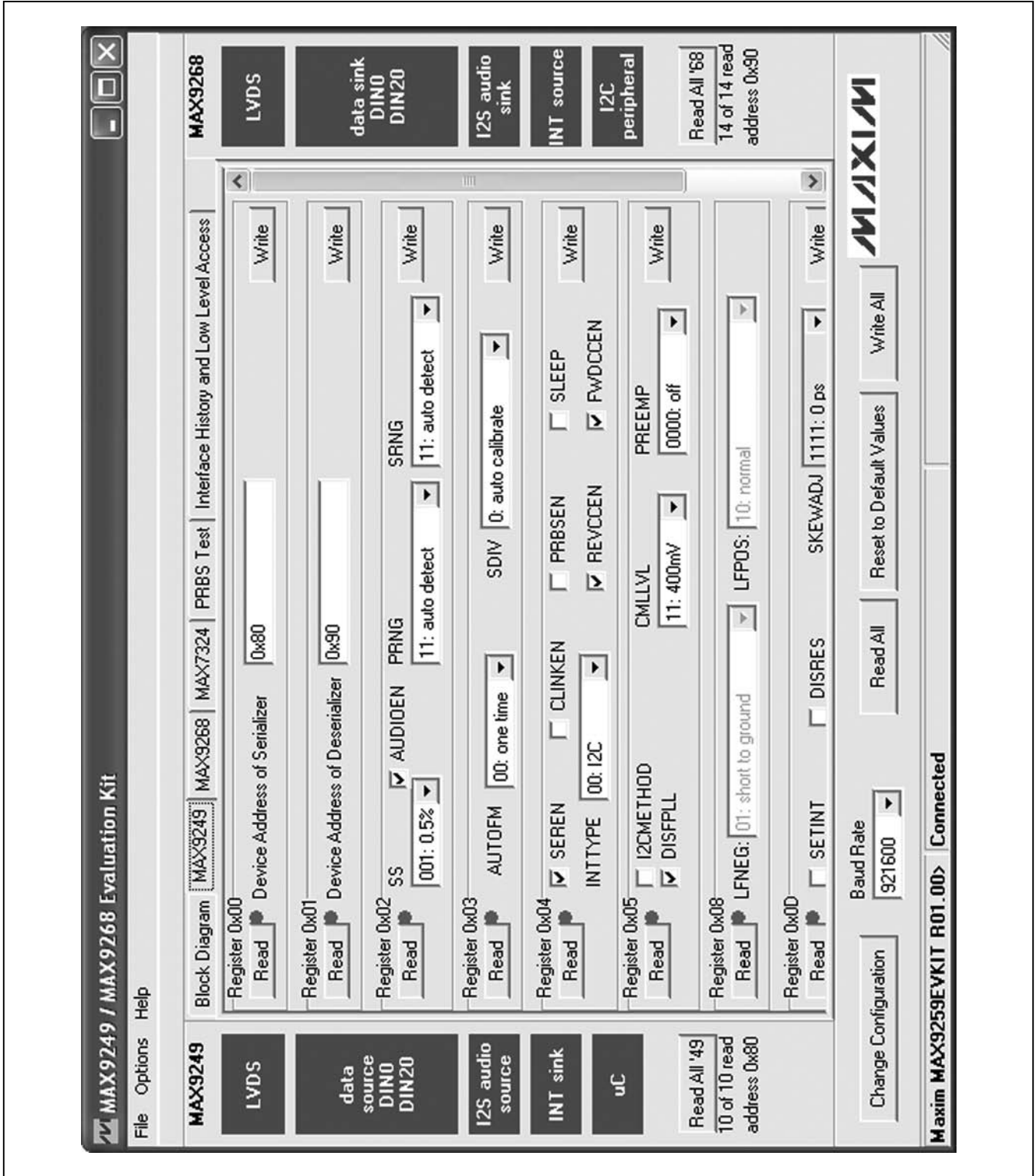

Figure 2. MAX9249/MAX9268 EV Kit Software Main Window (MAX9249 Tab)

MAX9268 Evaluation Kit

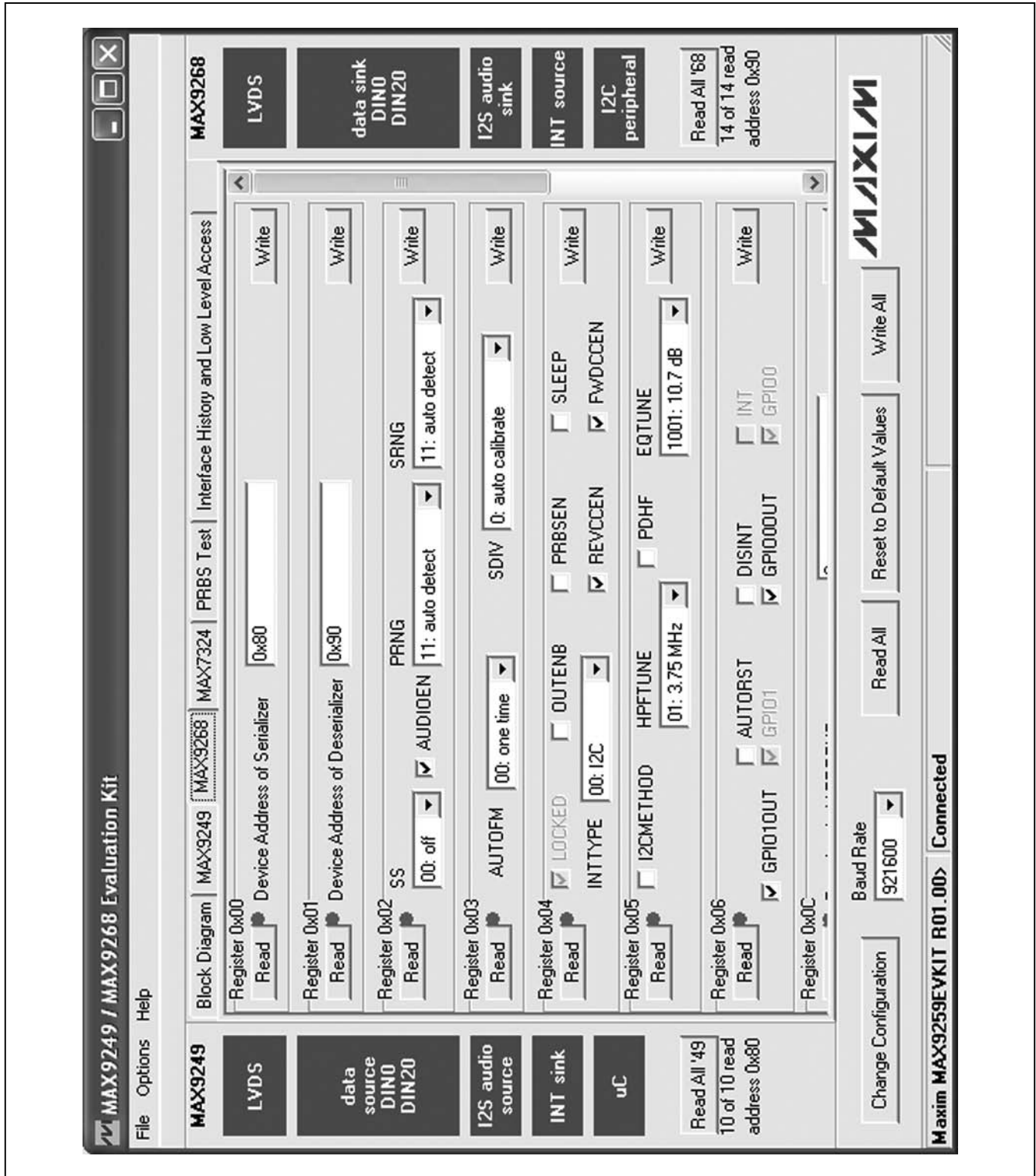

Figure 3. MAX9249/MAX9268 EV Kit Software Main Window (MAX9268 Tab)

MAX9268 Evaluation Kit

Evaluates: **MAX9268**

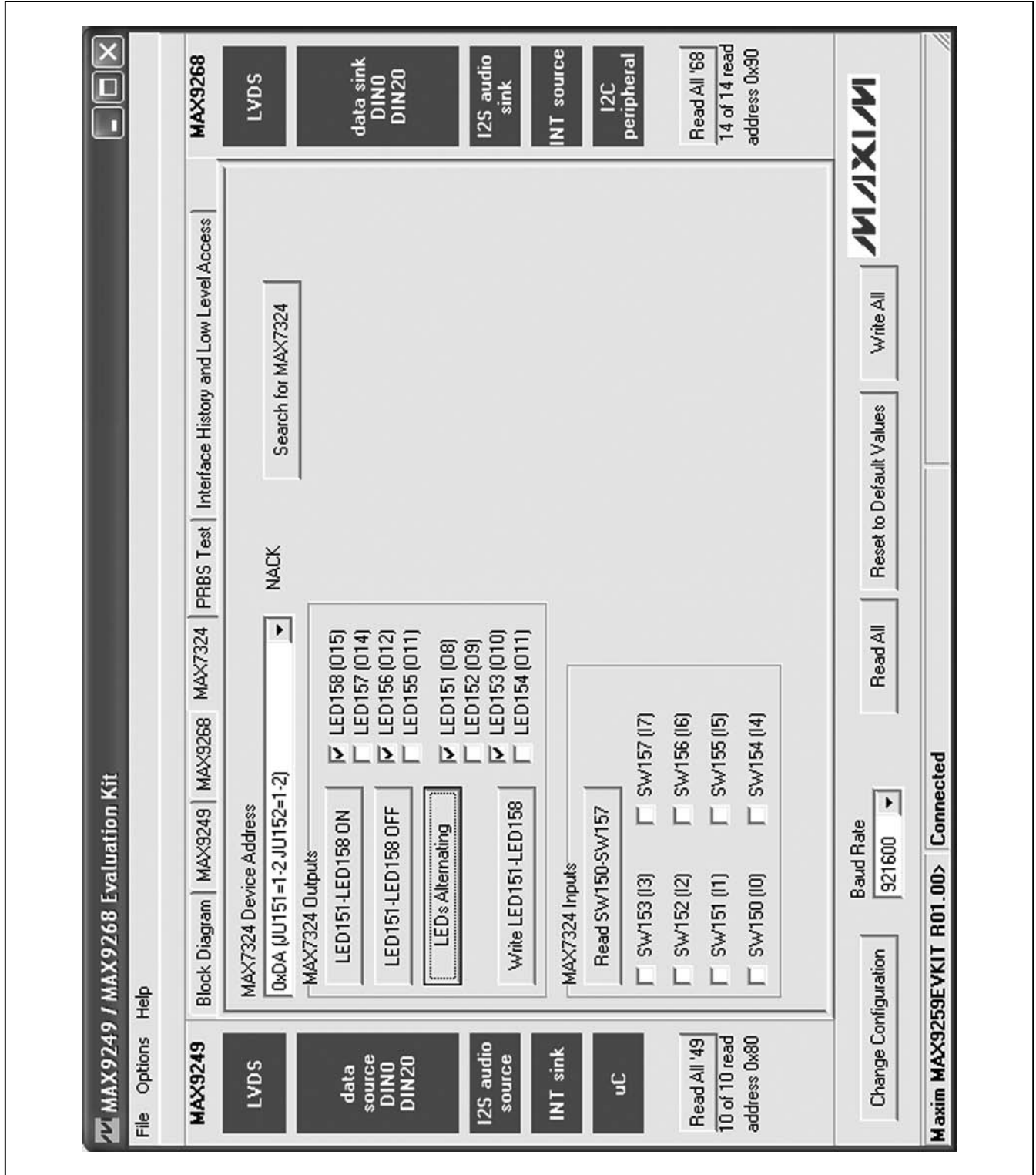

Figure 4. MAX9249/MAX9268 EV Kit Software Main Window (MAX7324 Tab)

MAX9268 Evaluation Kit

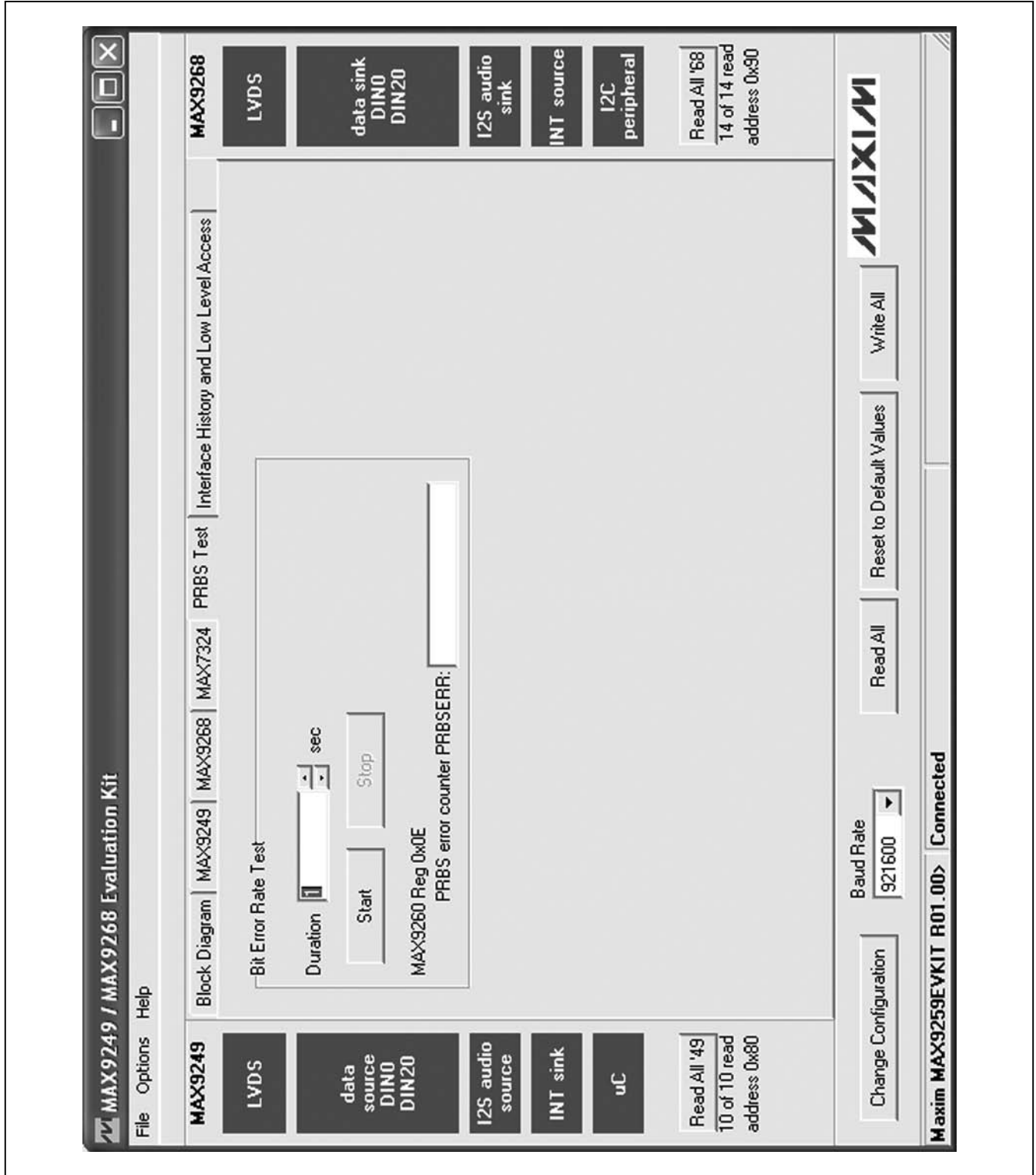

Figure 5. MAX9249/MAX9268 EV Kit Software Main Window (PRBS Test Tab)

MAX9268 Evaluation Kit

Evaluates: **MAX9268**

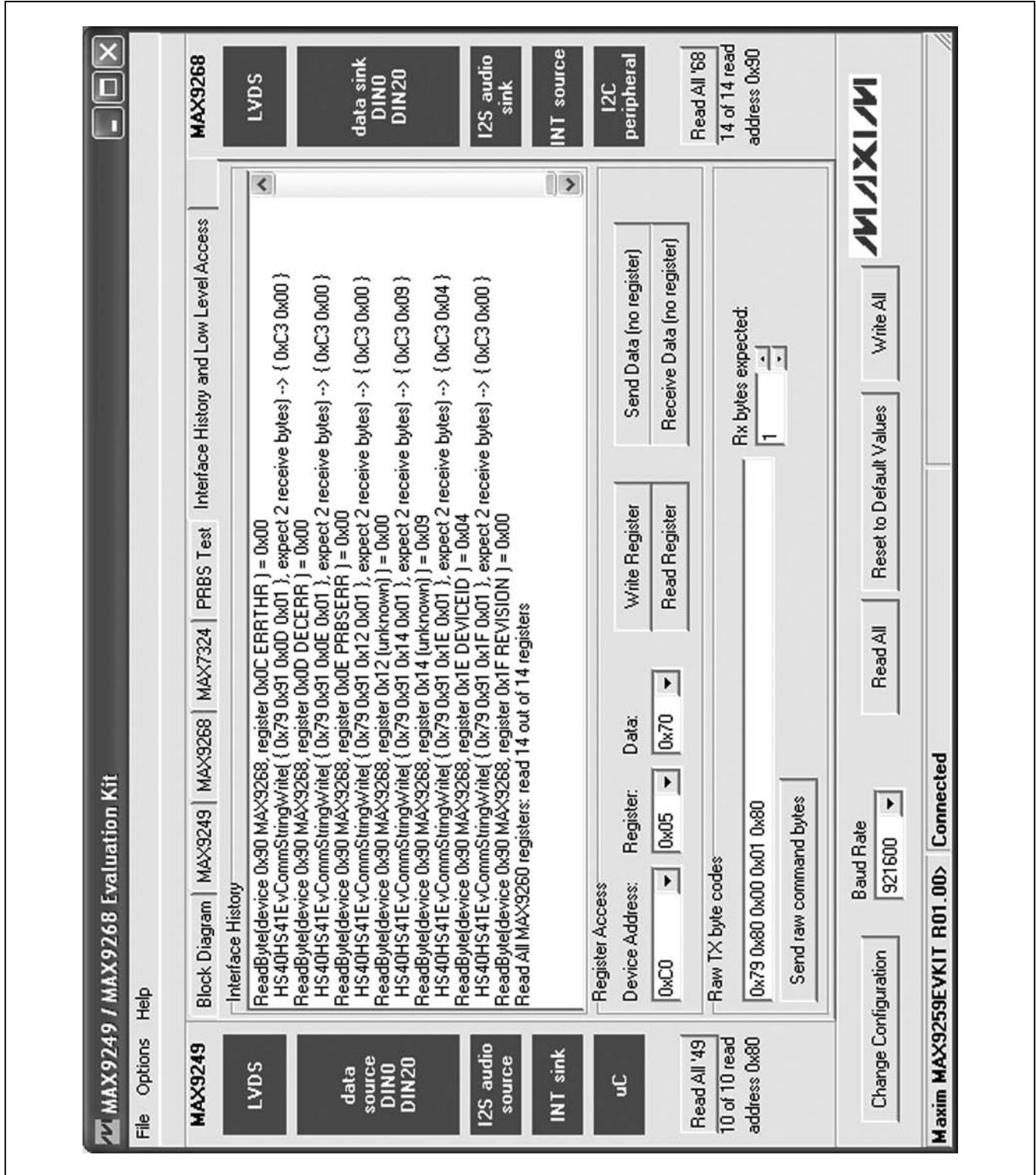

Figure 6. MAX9249/MAX9268 EV Kit Software Main Window (Interface History and Low Level Access Tab)

MAX9268 Evaluation Kit

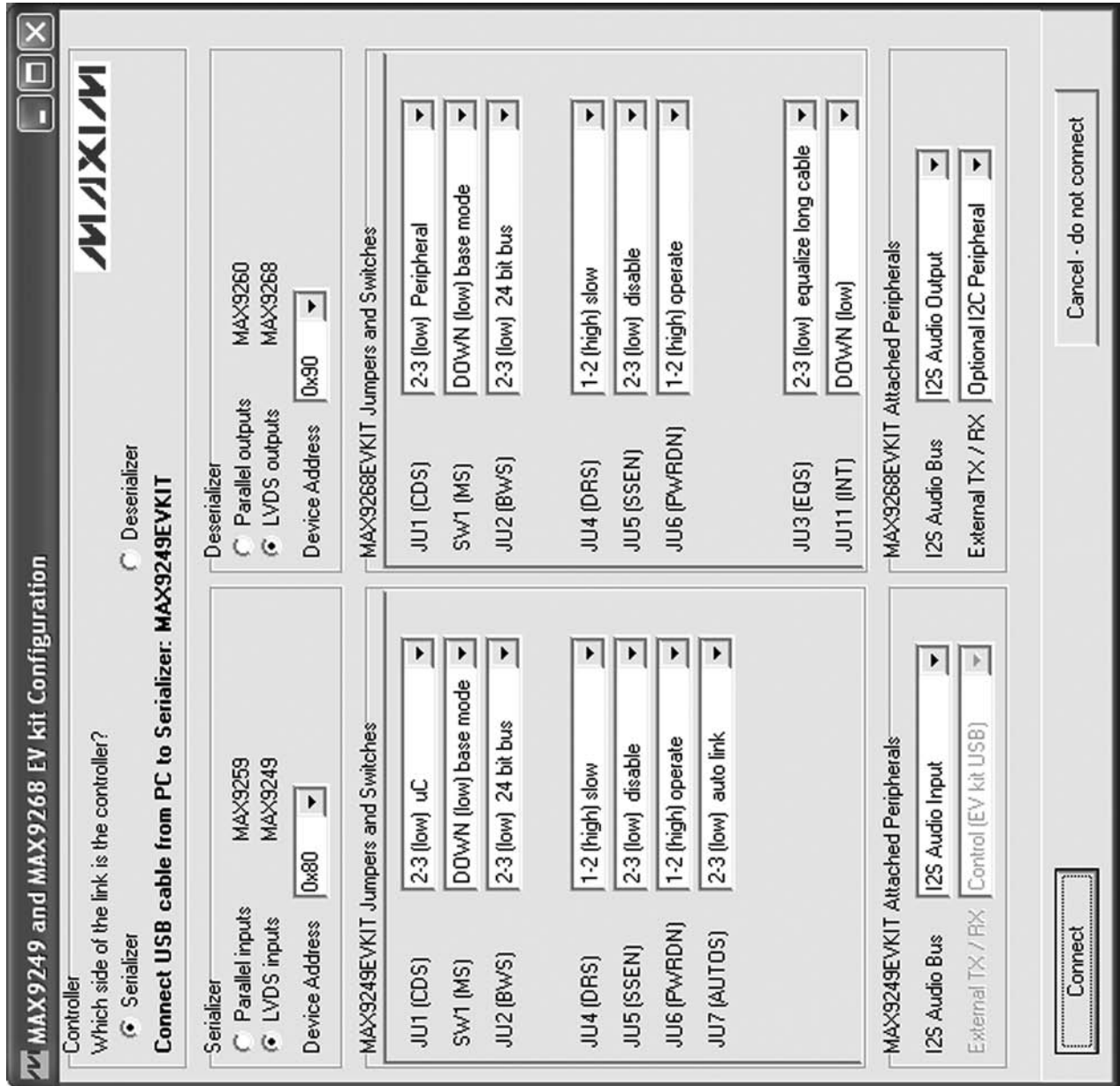

Figure 7. MAX9249/MAX9268 EV Kit Software Configuration Window

MAX9268 Evaluation Kit

Evaluates: MAX9268

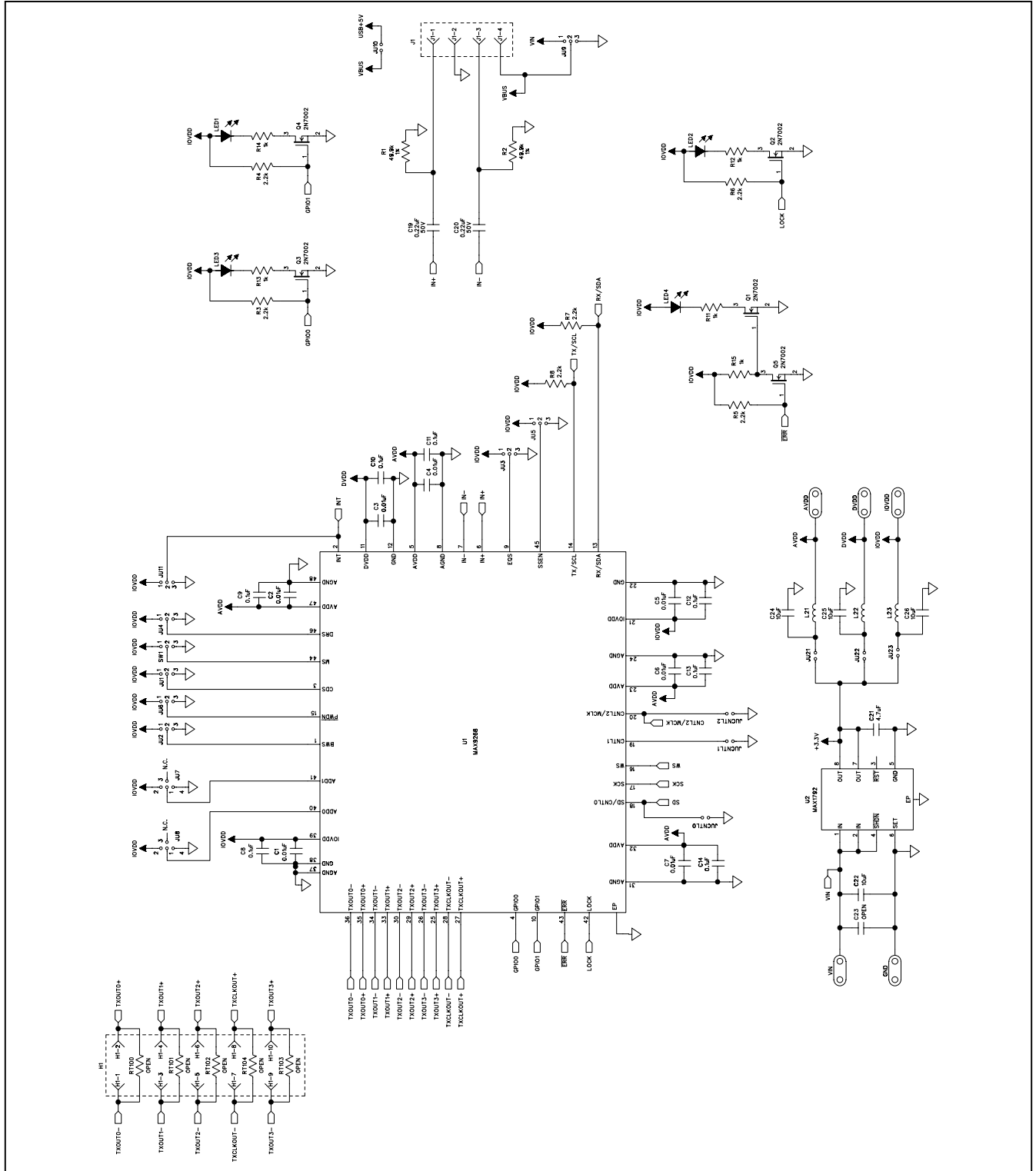
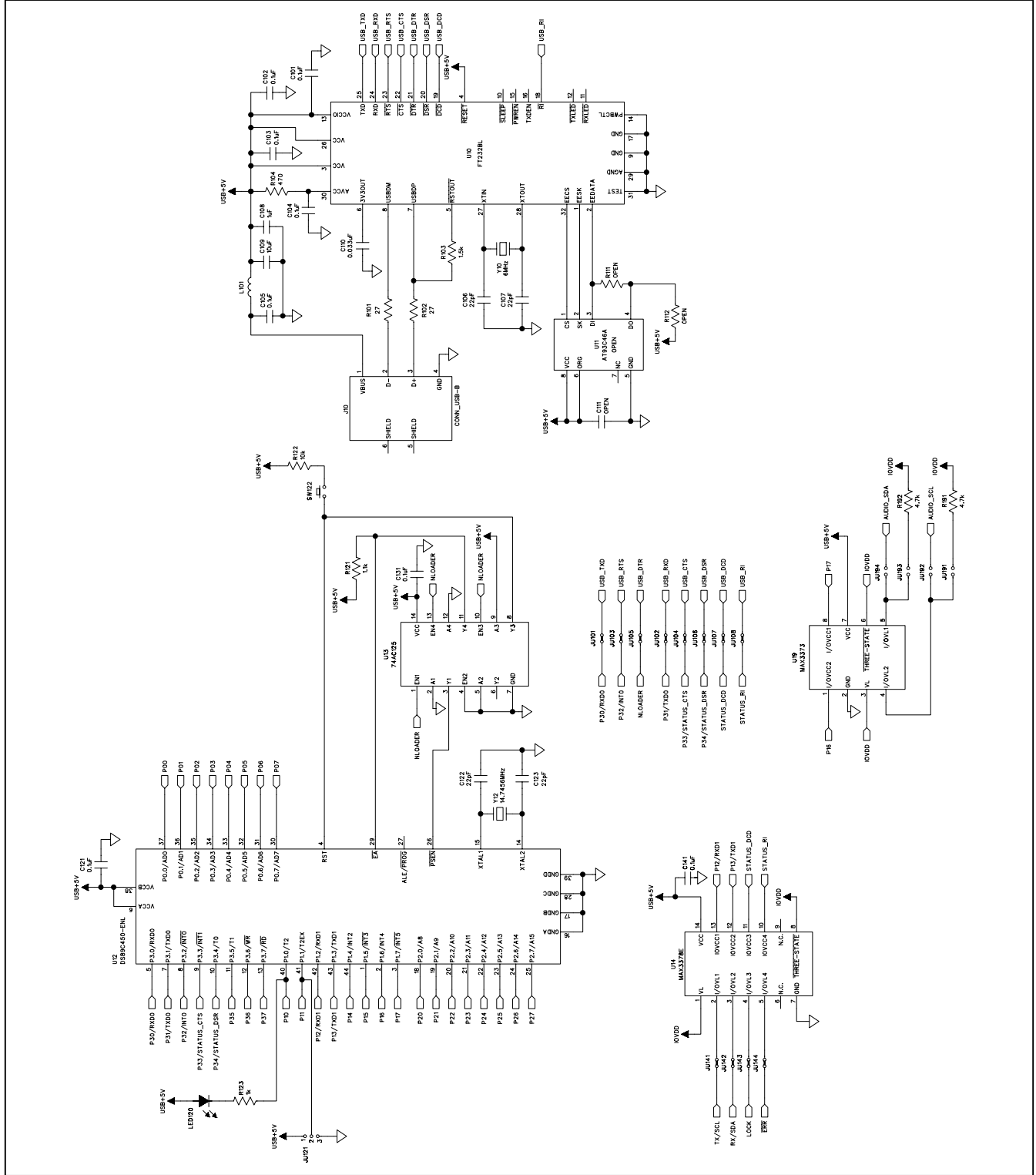

Figure 8a. MAX9268 EV Kit Schematic (Sheet 1 of 3)

MAX9268 Evaluation Kit



MAX9268 Evaluation Kit

Evaluates: MAX9268

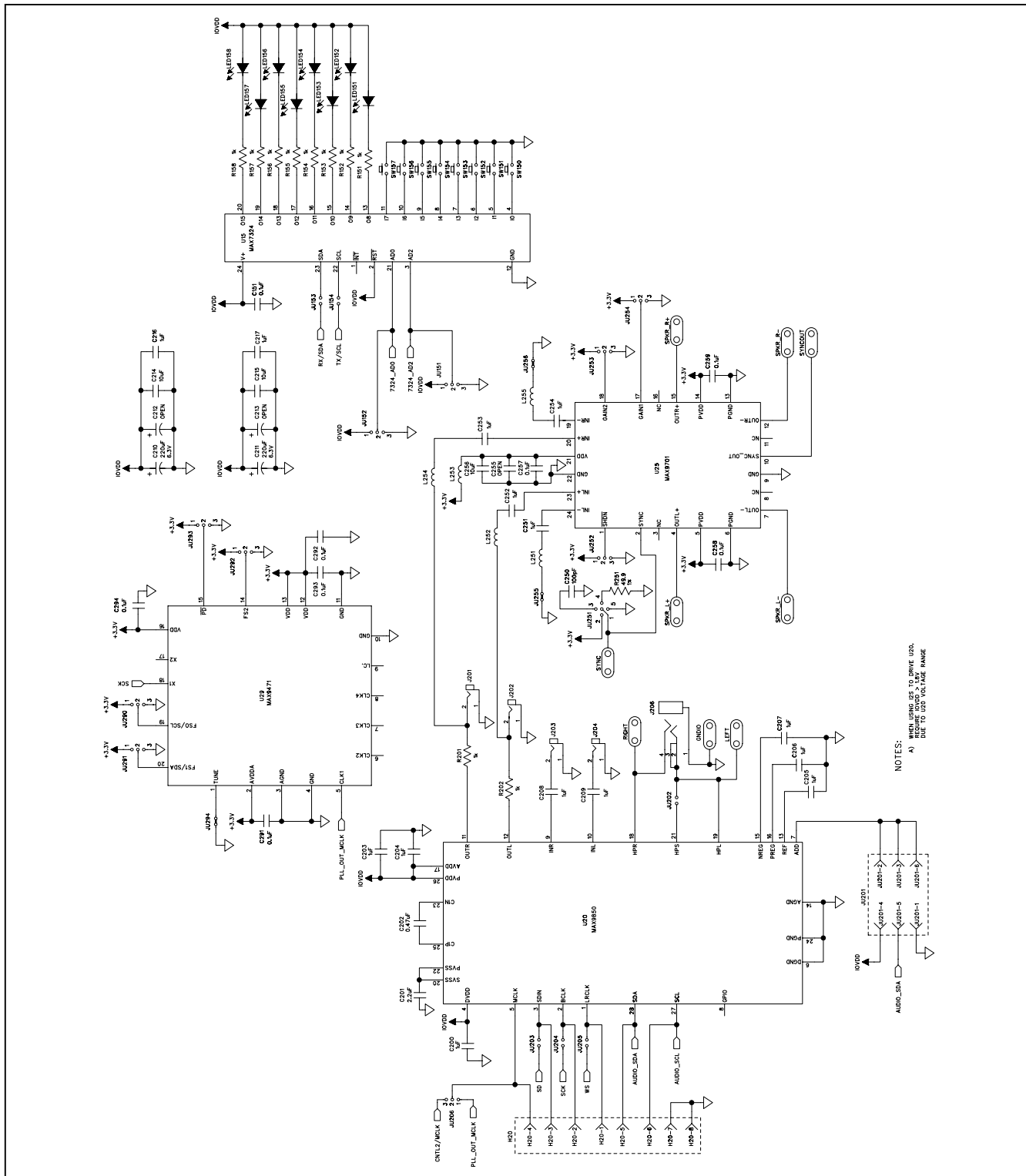

Figure 8c. MAX9268 EV Kit Schematic (Sheet 3 of 3)

MAX9268 Evaluation Kit

Evaluates: MAX9268

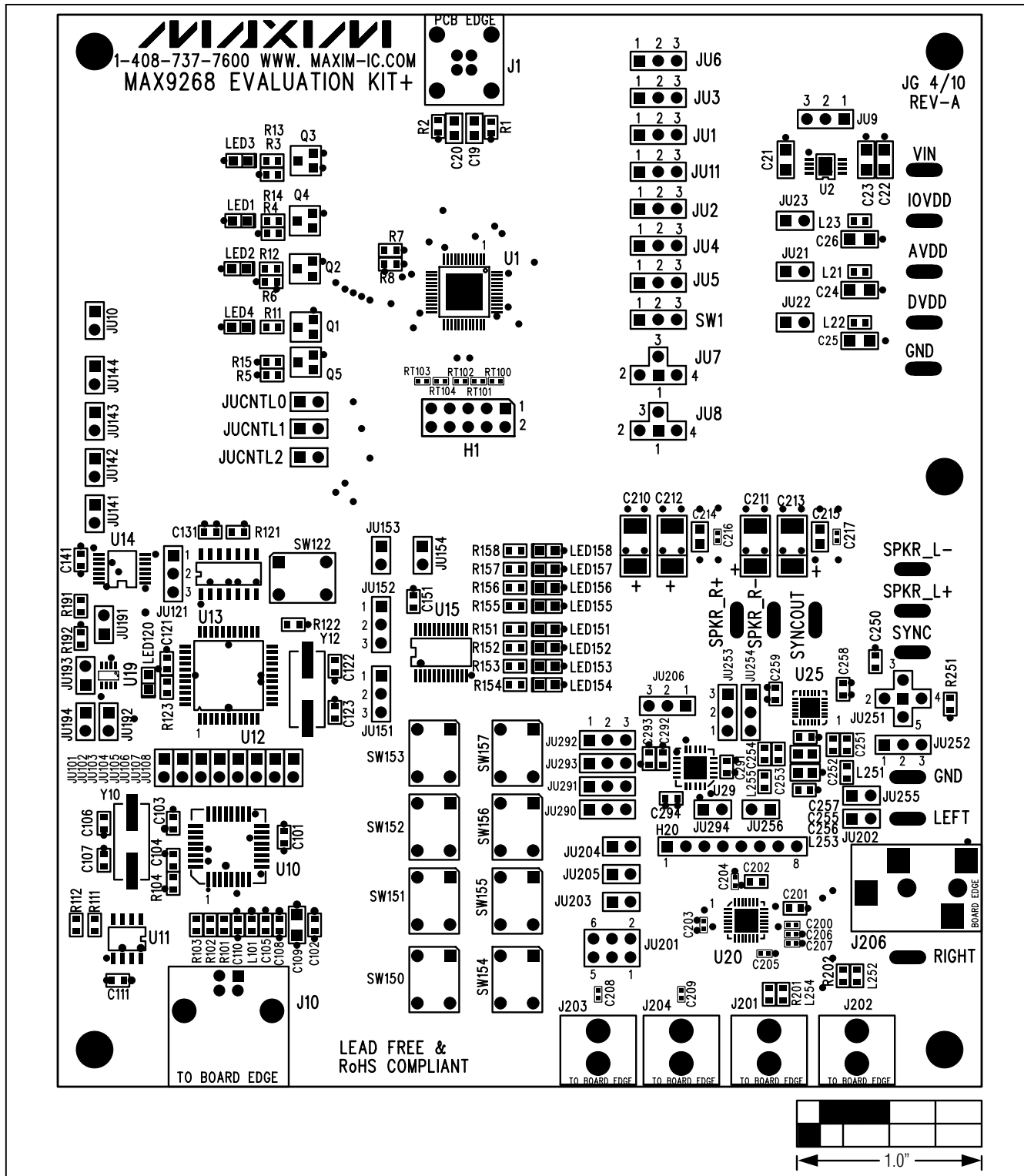

Figure 9. MAX9268 EV Kit Component Placement Guide—Component Side

MAX9268 Evaluation Kit

Evaluates: MAX9268

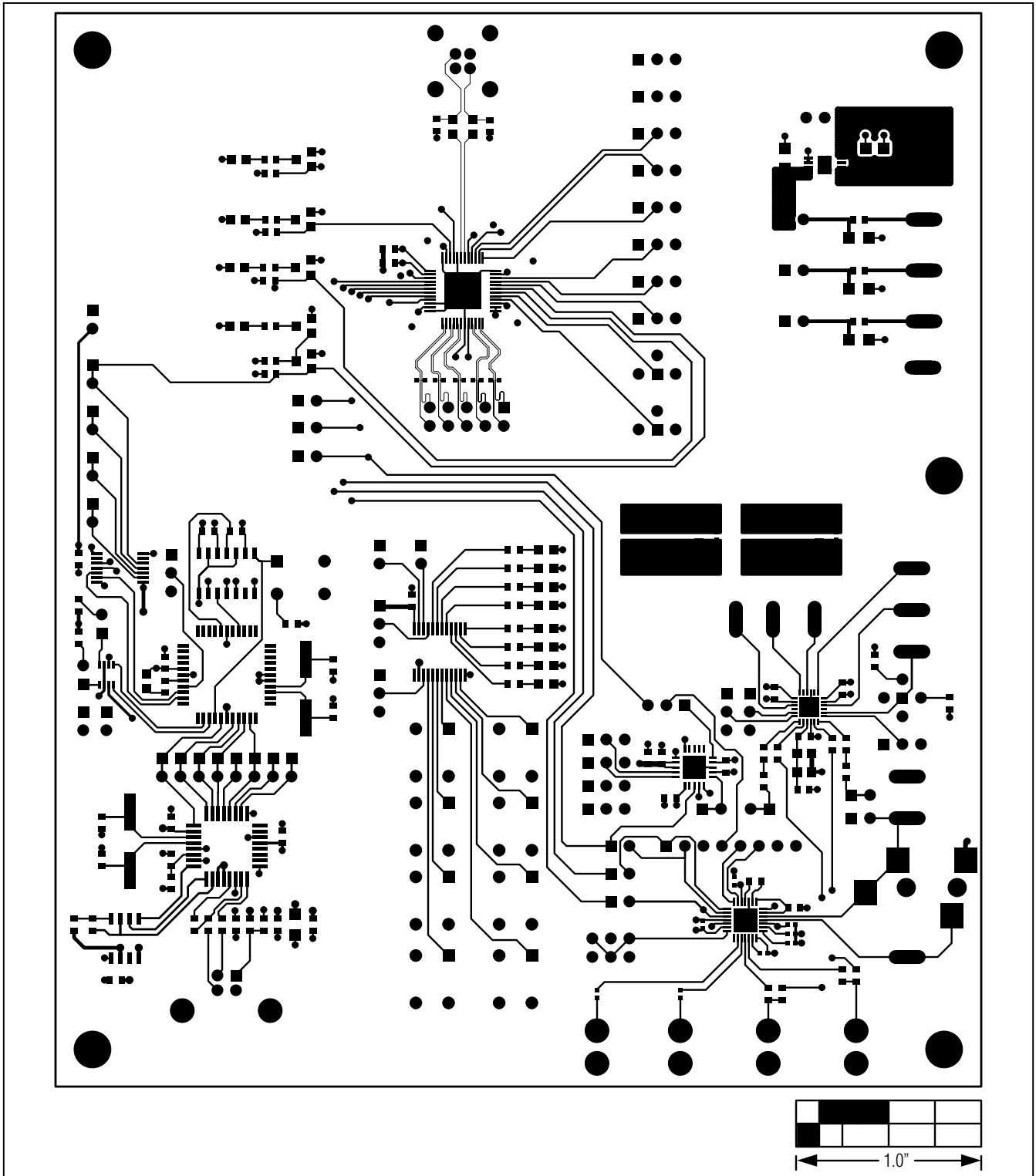

Figure 10. MAX9268 EV Kit PCB Layout—Component Side

MAX9268 Evaluation Kit

Evaluates: MAX9268

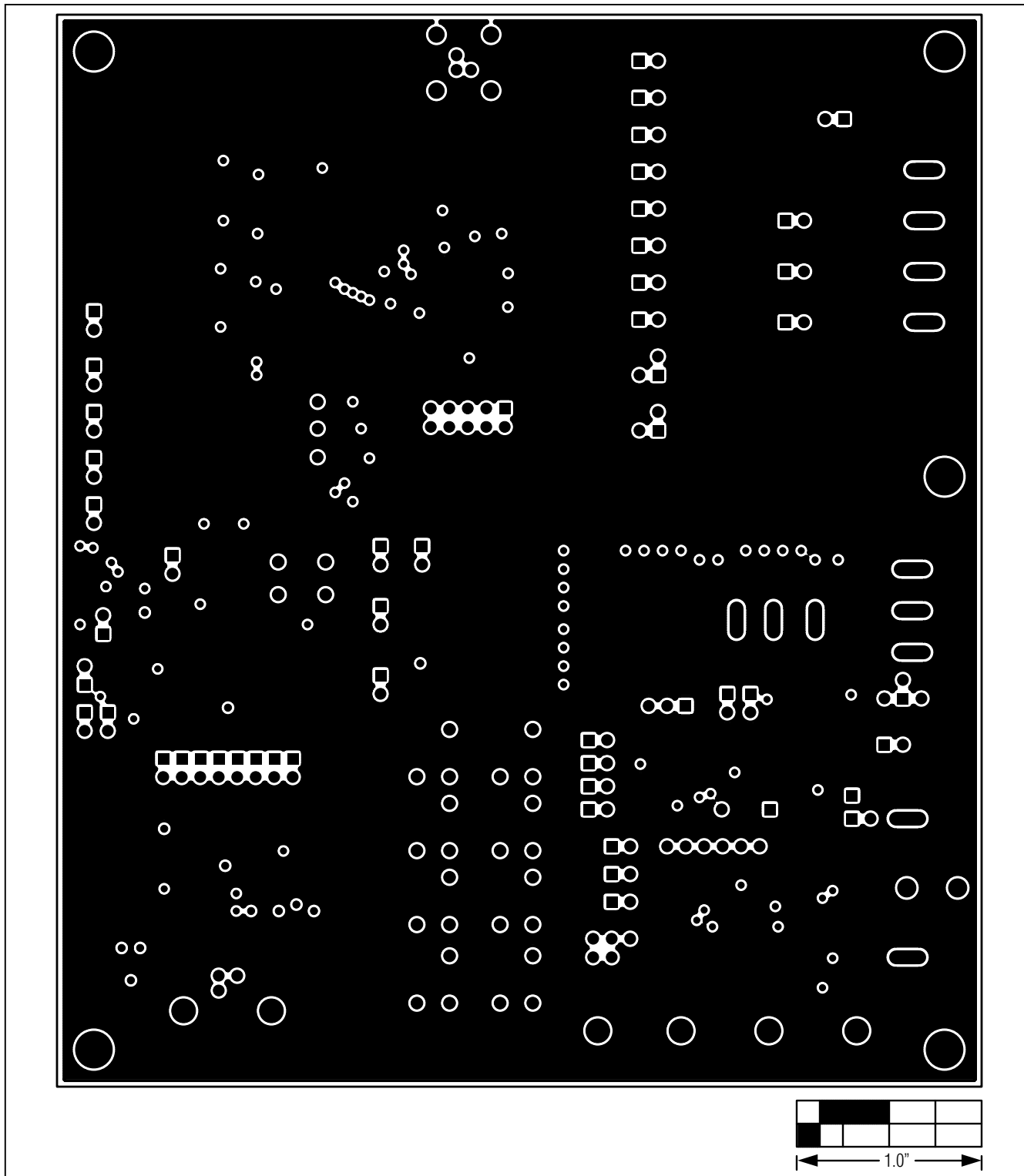

Figure 11. MAX9268 EV Kit PCB Layout—Ground Layer 2

MAX9268 Evaluation Kit

Evaluates: MAX9268

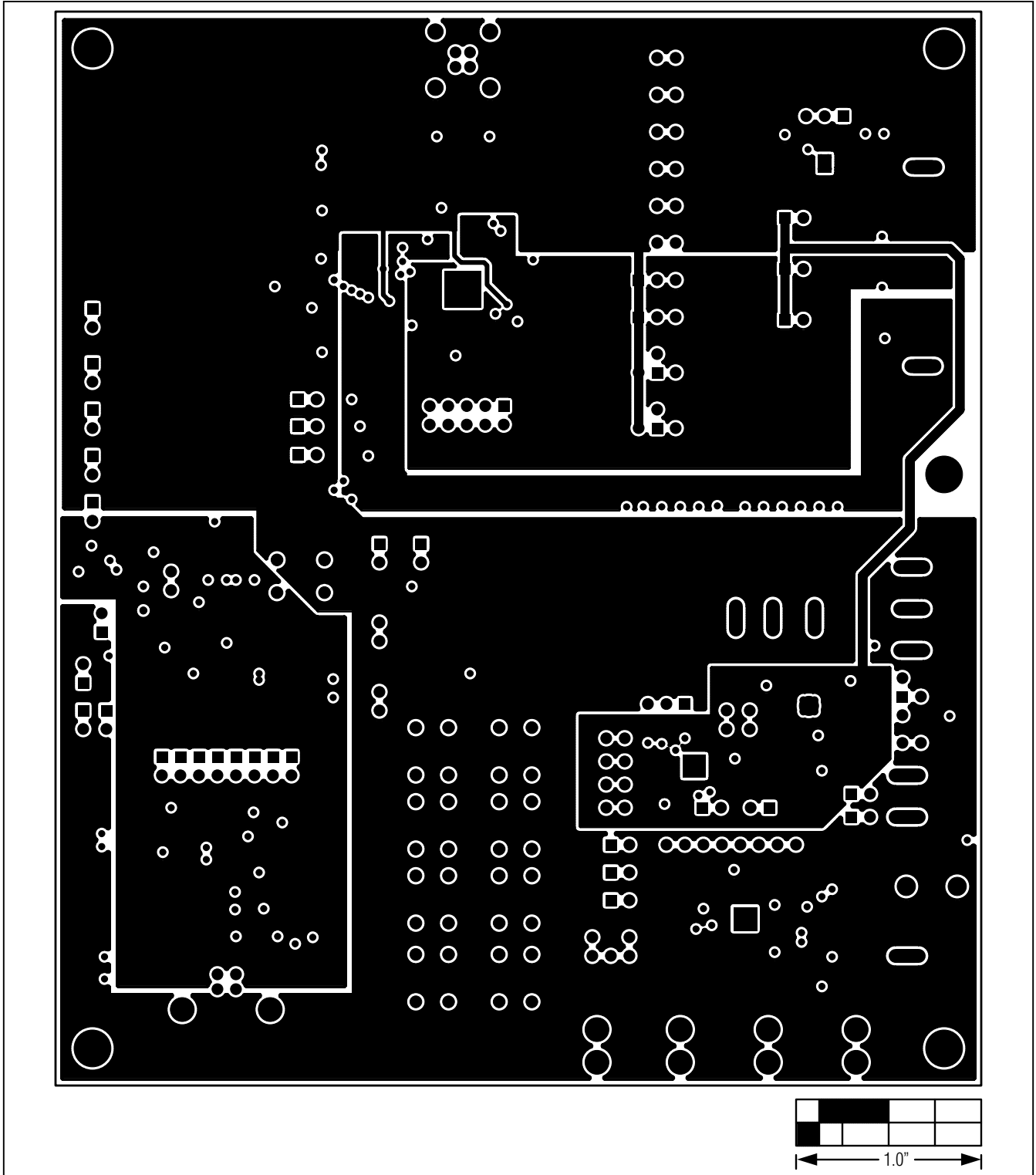

Figure 12. MAX9268 EV Kit PCB Layout—Power Layer 3

MAX9268 Evaluation Kit

Evaluates: MAX9268

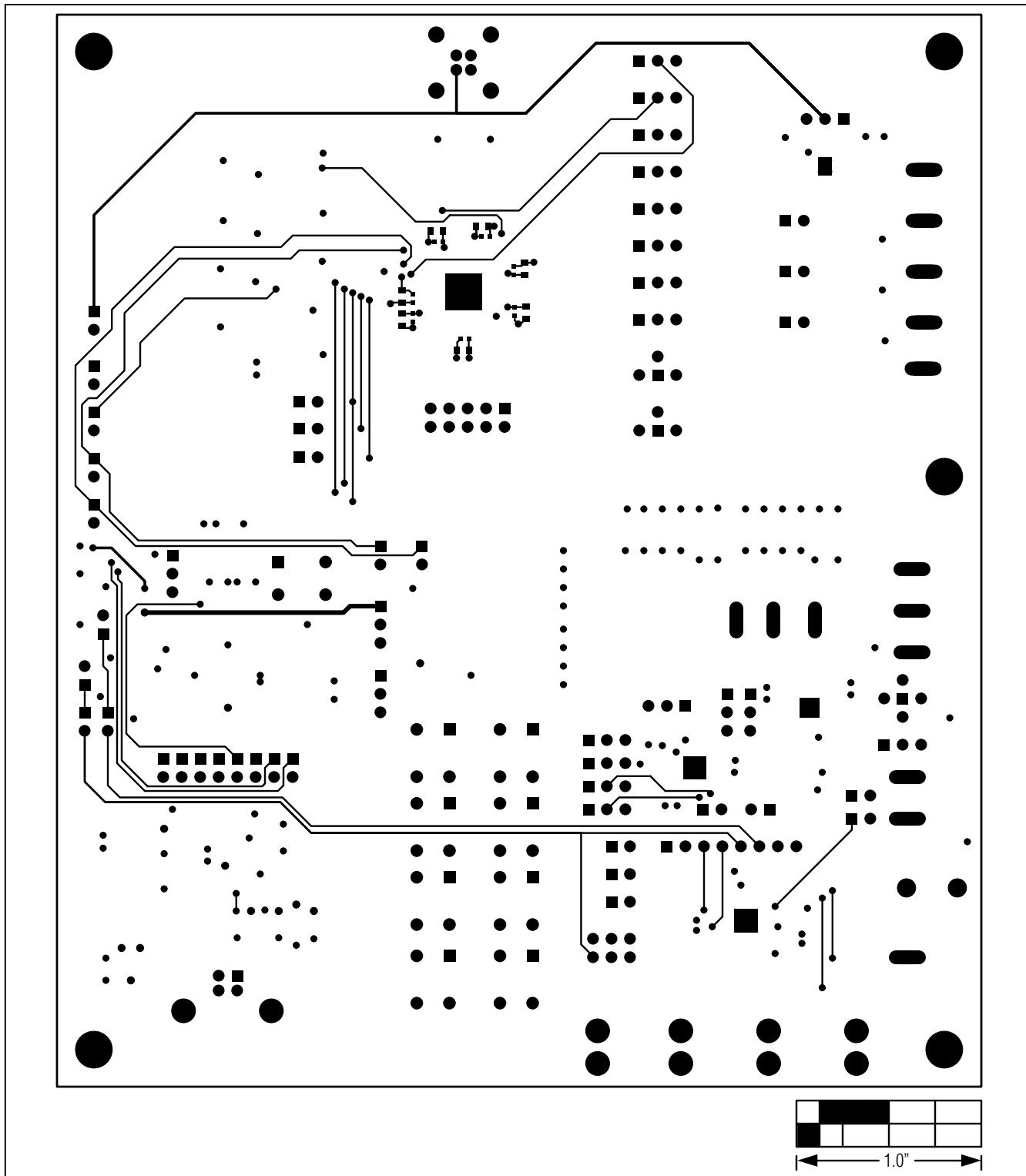

Figure 13. MAX9268 EV Kit PCB Layout—Solder Side

MAX9268 Evaluation Kit

Evaluates: MAX9268

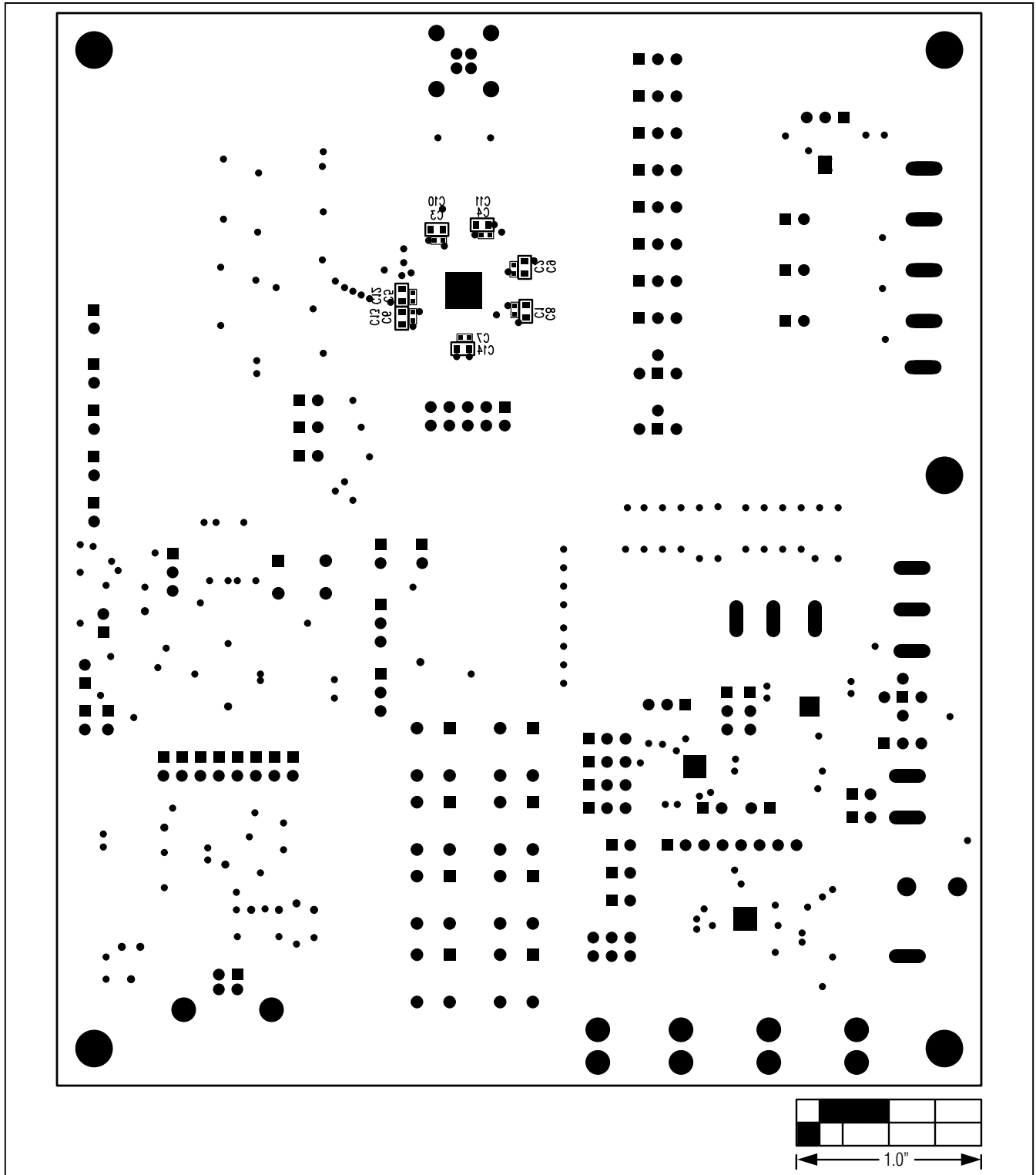

Figure 14. MAX9268 EV Kit Component Placement Guide—Solder Side

MAX9268 Evaluation Kit

Evaluates: MAX9268

Revision History

REVISION NUMBER	REVISION DATE	DESCRIPTION	PAGES CHANGED
0	5/10	Initial release	—

Maxim cannot assume responsibility for use of any circuitry other than circuitry entirely embodied in a Maxim product. No circuit patent licenses are implied. Maxim reserves the right to change the circuitry and specifications without notice at any time.

26 **Maxim Integrated Products, 120 San Gabriel Drive, Sunnyvale, CA 94086 408-737-7600**

© 2010 Maxim Integrated Products

Maxim is a registered trademark of Maxim Integrated Products, Inc.

Компания «Океан Электроники» предлагает заключение долгосрочных отношений при поставках импортных электронных компонентов на взаимовыгодных условиях!

Наши преимущества:

- Поставка оригинальных импортных электронных компонентов напрямую с производств Америки, Европы и Азии, а так же с крупнейших складов мира;
- Широкая линейка поставок активных и пассивных импортных электронных компонентов (более 30 млн. наименований);
- Поставка сложных, дефицитных, либо снятых с производства позиций;
- Оперативные сроки поставки под заказ (от 5 рабочих дней);
- Экспресс доставка в любую точку России;
- Помощь Конструкторского Отдела и консультации квалифицированных инженеров;
- Техническая поддержка проекта, помощь в подборе аналогов, поставка прототипов;
- Поставка электронных компонентов под контролем ВП;
- Система менеджмента качества сертифицирована по Международному стандарту ISO 9001;
- При необходимости вся продукция военного и аэрокосмического назначения проходит испытания и сертификацию в лаборатории (по согласованию с заказчиком);
- Поставка специализированных компонентов военного и аэрокосмического уровня качества (Xilinx, Altera, Analog Devices, Intersil, Interpoint, Microsemi, Actel, Aeroflex, Peregrine, VPT, Syfer, Eurofarad, Texas Instruments, MS Kennedy, Miteq, Cobham, E2V, MA-COM, Hittite, Mini-Circuits, General Dynamics и др.);

Компания «Океан Электроники» является официальным дистрибьютором и эксклюзивным представителем в России одного из крупнейших производителей разъемов военного и аэрокосмического назначения «JONHON», а так же официальным дистрибьютором и эксклюзивным представителем в России производителя высокотехнологичных и надежных решений для передачи СВЧ сигналов «FORSTAR».



JONHON

«JONHON» (основан в 1970 г.)

Разъемы специального, военного и аэрокосмического назначения:

(Применяются в военной, авиационной, аэрокосмической, морской, железнодорожной, горно- и нефтедобывающей отраслях промышленности)

«FORSTAR» (основан в 1998 г.)

ВЧ соединители, коаксиальные кабели, кабельные сборки и микроволновые компоненты:

(Применяются в телекоммуникациях гражданского и специального назначения, в средствах связи, РЛС, а так же военной, авиационной и аэрокосмической отраслях промышленности).



Телефон: 8 (812) 309-75-97 (многоканальный)

Факс: 8 (812) 320-03-32

Электронная почта: ocean@oceanchips.ru

Web: <http://oceanchips.ru/>

Адрес: 198099, г. Санкт-Петербург, ул. Калинина, д. 2, корп. 4, лит. А