

The S-814 Series is a low dropout voltage, high output voltage accuracy and low current consumption positive voltage regulator developed utilizing CMOS technology.

Built-in low ON-resistance transistors provide low dropout voltage and large output current. The ON/OFF circuit ensures long battery life.

Various types of output capacitors can be used in the S-814 Series compared with the past CMOS voltage regulators. (i.e., Small ceramic capacitors can also be used in the S-814 Series.)

The SOT-23-5 miniaturized package and the SOT-89-5 packages are recommended to use for configuring portable devices and large output current applications, respectively.

## ■ Features

- Output voltage: 2.0 V to 6.0 V, selectable in 0.1 V step
- Output voltage accuracy:  $\pm 2.0\%$
- Dropout voltage: 170 mV typ. (5.0 V output product,  $I_{OUT}=60$  mA)
- Current consumption: During operation: 30  $\mu$ A typ., 40  $\mu$ A max.  
During power-off: 100 nA typ., 500 nA max.
- Output current: Possible to output 110 mA (3.0 V output product,  $V_{IN}=4$  V)<sup>\*1</sup>  
Possible to output 180 mA (5.0 V output product,  $V_{IN}=6$  V)<sup>\*1</sup>
- Output capacitor: A ceramic capacitor of 0.47  $\mu$ F or more can be used.
- Built-in ON/OFF circuit: Ensures long battery life.
- Built-in short-circuit protection circuit
- Operation temperature range:  $T_a=-40^{\circ}\text{C}$  to  $+85^{\circ}\text{C}$
- Lead-free, Sn 100%, halogen-free<sup>\*2</sup>

\*1. Attention should be paid to the power dissipation of the package when the output current is large.

\*2. Refer to “■ Product Name Structure” for details.

## ■ Applications

- Constant-voltage power source for battery-powered device, personal communication device, and home electric appliance.

## ■ Packages

- SOT-23-5
- SOT-89-5

■ Block Diagram



\*1. Parasitic diode

Figure 1

■ Product Name Structure

1. Product Name

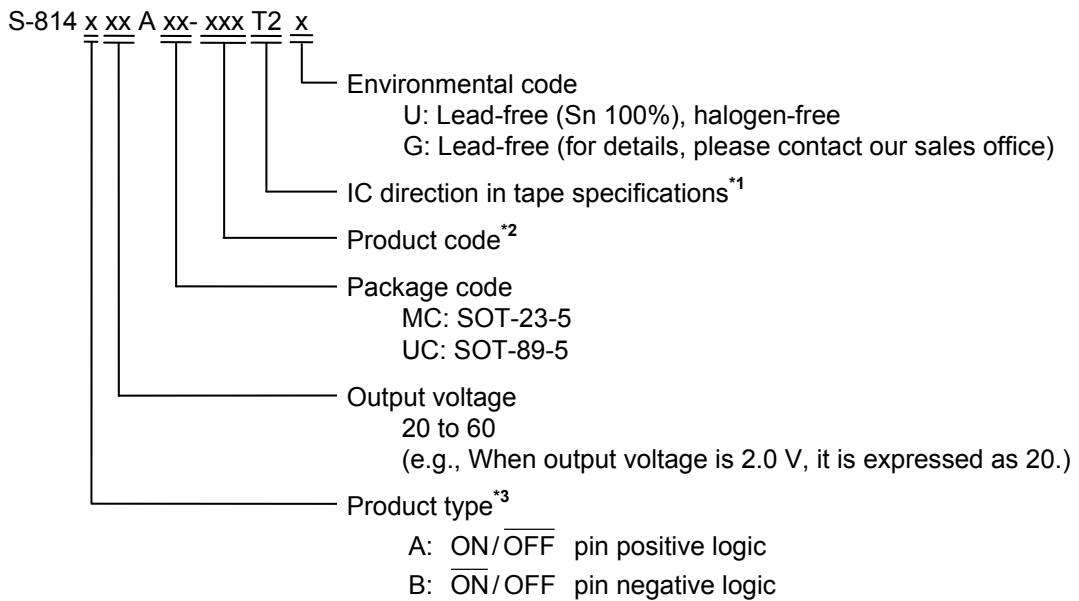

\*1. Refer to the tape drawing.

\*2. Refer to "3. Product Name List".

\*3. Refer to "3. ON/OFF pin" in "■ Operation".

2. Packages

Package Name	Drawing Code		
	Package	Tape	Reel
SOT-23-5	MP005-A-P-SD	MP005-A-C-SD	MP005-A-R-SD
SOT-89-5	UP005-A-P-SD	UP005-A-C-SD	UP005-A-R-SD

**3. Product Name List**

**Table 1**

Output voltage	SOT-23-5	SOT-89-5
2.0 V $\pm$ 2.0 %	S-814A20AMC-BCKT2x	S-814A20AUC-BCKT2x
2.1 V $\pm$ 2.0 %	S-814A21AMC-BCLT2x	S-814A21AUC-BCLT2x
2.2 V $\pm$ 2.0 %	S-814A22AMC-BCMT2x	S-814A22AUC-BCMT2x
2.3 V $\pm$ 2.0 %	S-814A23AMC-BCNT2x	S-814A23AUC-BCNT2x
2.4 V $\pm$ 2.0 %	S-814A24AMC-BCOT2x	S-814A24AUC-BCOT2x
2.5 V $\pm$ 2.0 %	S-814A25AMC-BCPT2x	S-814A25AUC-BCPT2x
2.6 V $\pm$ 2.0 %	S-814A26AMC-BCQT2x	S-814A26AUC-BCQT2x
2.7 V $\pm$ 2.0 %	S-814A27AMC-BCRT2x	S-814A27AUC-BCRT2x
2.8 V $\pm$ 2.0 %	S-814A28AMC-BCST2x	S-814A28AUC-BCST2x
2.9 V $\pm$ 2.0 %	S-814A29AMC-BCTT2x	S-814A29AUC-BCTT2x
3.0 V $\pm$ 2.0 %	S-814A30AMC-BCUT2x	S-814A30AUC-BCUT2x
3.1 V $\pm$ 2.0 %	S-814A31AMC-BCVT2x	S-814A31AUC-BCVT2x
3.2 V $\pm$ 2.0 %	S-814A32AMC-BCWT2x	S-814A32AUC-BCWT2x
3.3 V $\pm$ 2.0 %	S-814A33AMC-BCXT2x	S-814A33AUC-BCXT2x
3.4 V $\pm$ 2.0 %	S-814A34AMC-BCYT2x	S-814A34AUC-BCYT2x
3.5 V $\pm$ 2.0 %	S-814A35AMC-BCZT2x	S-814A35AUC-BCZT2x
3.6 V $\pm$ 2.0 %	S-814A36AMC-BDAT2x	S-814A36AUC-BDAT2x
3.7 V $\pm$ 2.0 %	S-814A37AMC-BDBT2x	S-814A37AUC-BDBT2x
3.8 V $\pm$ 2.0 %	S-814A38AMC-BDCT2x	S-814A38AUC-BDCT2x
3.9 V $\pm$ 2.0 %	S-814A39AMC-BDDT2x	S-814A39AUC-BDDT2x
4.0 V $\pm$ 2.0 %	S-814A40AMC-BDET2x	S-814A40AUC-BDET2x
4.1 V $\pm$ 2.0 %	S-814A41AMC-BDFT2x	S-814A41AUC-BDFT2x
4.2 V $\pm$ 2.0 %	S-814A42AMC-BDGT2x	S-814A42AUC-BDGT2x
4.3 V $\pm$ 2.0 %	S-814A43AMC-BDHT2x	S-814A43AUC-BDHT2x
4.4 V $\pm$ 2.0 %	S-814A44AMC-BDIT2x	S-814A44AUC-BDIT2x
4.5 V $\pm$ 2.0 %	S-814A45AMC-BDJT2x	S-814A45AUC-BDJT2x
4.6 V $\pm$ 2.0 %	S-814A46AMC-BDKT2x	S-814A46AUC-BDKT2x
4.7 V $\pm$ 2.0 %	S-814A47AMC-BDLT2x	S-814A47AUC-BDLT2x
4.8 V $\pm$ 2.0 %	S-814A48AMC-BDMT2x	S-814A48AUC-BDMT2x
4.9 V $\pm$ 2.0 %	S-814A49AMC-BDNT2x	S-814A49AUC-BDNT2x
5.0 V $\pm$ 2.0 %	S-814A50AMC-BDOT2x	S-814A50AUC-BDOT2x
5.1 V $\pm$ 2.0 %	S-814A51AMC-BDPT2x	S-814A51AUC-BDPT2x
5.2 V $\pm$ 2.0 %	S-814A52AMC-BDQT2x	S-814A52AUC-BDQT2x
5.3 V $\pm$ 2.0 %	S-814A53AMC-BDRT2x	S-814A53AUC-BDRT2x
5.4 V $\pm$ 2.0 %	S-814A54AMC-BDST2x	S-814A54AUC-BDST2x
5.5 V $\pm$ 2.0 %	S-814A55AMC-BDTT2x	S-814A55AUC-BDTT2x
5.6 V $\pm$ 2.0 %	S-814A56AMC-BDUT2x	S-814A56AUC-BDUT2x
5.7 V $\pm$ 2.0 %	S-814A57AMC-BDVT2x	S-814A57AUC-BDVT2x
5.8 V $\pm$ 2.0 %	S-814A58AMC-BDWT2x	S-814A58AUC-BDWT2x
5.9 V $\pm$ 2.0 %	S-814A59AMC-BDXT2x	S-814A59AUC-BDXT2x
6.0 V $\pm$ 2.0 %	S-814A60AMC-BDYT2x	S-814A60AUC-BDYT2x

**Remark 1.** Please contact our sales office for type B products.

**2.** x: G or U

**3.** Please select products of environmental code = U for Sn 100%, halogen-free products.

### ■ Pin Configurations



**Figure 2**

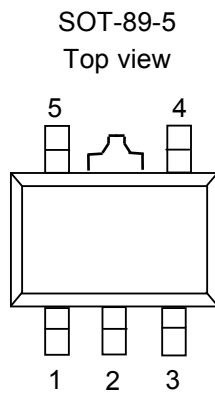

**Figure 3**

**Table 2**

Pin No.	Symbol	Pin description
1	VIN	Voltage input pin
2	VSS	GND pin
3	ON/OFF	ON/OFF pin
4	NC* <sup>1</sup>	No connection
5	VOUT	Voltage output pin

\*1. The NC pin is electrically open.

The NC pin can be connected to the VIN pin or the VSS pin.

**Table 3**

Pin No.	Symbol	Pin description
1	VOUT	Voltage output pin
2	VSS	GND pin
3	NC* <sup>1</sup>	No connection
4	ON/OFF	ON/OFF pin
5	VIN	Voltage input pin

\*1. The NC pin is electrically open.

The NC pin can be connected to the VIN pin or the VSS pin.

■ **Absolute Maximum Ratings**

**Table 4**

(Ta=25°C unless otherwise specified)

Item	Symbol	Absolute maximum rating	Unit
Input voltage	V <sub>IN</sub>	V <sub>SS</sub> -0.3 to V <sub>SS</sub> +12	V
	V <sub>ON/OFF</sub>	V <sub>SS</sub> -0.3 to V <sub>SS</sub> +12	V
Output voltage	V <sub>OUT</sub>	V <sub>SS</sub> -0.3 to V <sub>IN</sub> +0.3	V
Power dissipation	P <sub>D</sub>	250 (When not mounted on board)	mW
		600 <sup>*1</sup>	mW
		500 (When not mounted on board)	mW
		1000 <sup>*1</sup>	mW
Operation ambient temperature	T <sub>opr</sub>	-40 to +85	°C
Storage temperature	T <sub>stg</sub>	-40 to +125	°C

\*1. When mounted on board

[Mounted on board]

(1) Board size : 114.3 mm × 76.2 mm × t1.6 mm

(2) Board name : JEDEC STANDARD51-7

**Caution** The absolute maximum ratings are rated values exceeding which the product could suffer physical damage. These values must therefore not be exceeded under any conditions.



**Figure 4 Power Dissipation of Package (When Mounted on Board)**

**■ Electrical Characteristics**

**Table 5**

(Ta=25°C unless otherwise specified)

Item	Symbol	Condition	Min.	Typ.	Max.	Units	Test circuit	
Output voltage <sup>*1</sup>	$V_{OUT(E)}$	$V_{IN}=V_{OUT(S)}+1\text{ V}$ , $I_{OUT}=30\text{ mA}$	$V_{OUT(S)} \times 0.98$	$V_{OUT(S)}$	$V_{OUT(S)} \times 1.02$	V	1	
Output current <sup>*2</sup>	$I_{OUT}$	$V_{OUT(S)}+1\text{ V} \leq V_{IN} \leq 10\text{ V}$	$2.0\text{ V} \leq V_{OUT(S)} \leq 2.9\text{ V}$	$100^{*3}$	—	—	mA	3
			$3.0\text{ V} \leq V_{OUT(S)} \leq 3.9\text{ V}$	$110^{*3}$	—	—	mA	3
			$4.0\text{ V} \leq V_{OUT(S)} \leq 4.9\text{ V}$	$135^{*3}$	—	—	mA	3
			$5.0\text{ V} \leq V_{OUT(S)} \leq 6.0\text{ V}$	$180^{*3}$	—	—	mA	3
Dropout voltage <sup>*4</sup>	$V_{drop}$	$I_{OUT}=60\text{ mA}$	$2.0\text{ V} \leq V_{OUT(S)} \leq 2.4\text{ V}$	—	0.51	0.87	V	1
			$2.5\text{ V} \leq V_{OUT(S)} \leq 2.9\text{ V}$	—	0.38	0.61	V	1
			$3.0\text{ V} \leq V_{OUT(S)} \leq 3.4\text{ V}$	—	0.30	0.44	V	1
			$3.5\text{ V} \leq V_{OUT(S)} \leq 3.9\text{ V}$	—	0.24	0.33	V	1
			$4.0\text{ V} \leq V_{OUT(S)} \leq 4.4\text{ V}$	—	0.20	0.26	V	1
			$4.5\text{ V} \leq V_{OUT(S)} \leq 4.9\text{ V}$	—	0.18	0.22	V	1
			$5.0\text{ V} \leq V_{OUT(S)} \leq 5.4\text{ V}$	—	0.17	0.21	V	1
		$5.5\text{ V} \leq V_{OUT(S)} \leq 6.0\text{ V}$	—	0.17	0.20	V	1	
Line regulation 1	$\frac{\Delta V_{OUT1}}{\Delta V_{IN} \cdot V_{OUT}}$	$V_{OUT(S)}+0.5\text{ V} \leq V_{IN} \leq 10\text{ V}$ , $I_{OUT}=30\text{ mA}$	—	0.05	0.2	%/V	1	
Line regulation 2	$\frac{\Delta V_{OUT2}}{\Delta V_{IN} \cdot V_{OUT}}$	$V_{OUT(S)}+0.5\text{ V} \leq V_{IN} \leq 10\text{ V}$ , $I_{OUT}=10\text{ }\mu\text{A}$	—	0.05	0.2	%/V	1	
Load regulation	$\Delta V_{OUT3}$	$V_{IN}=V_{OUT(S)}+1\text{ V}$ , $10\text{ }\mu\text{A} \leq I_{OUT} \leq 80\text{ mA}$	—	30	50	mV	1	
Output voltage temperature coefficient <sup>*5</sup>	$\frac{\Delta V_{OUT}}{\Delta T_a \cdot V_{OUT}}$	$V_{IN}=V_{OUT(S)}+1\text{ V}$ , $I_{OUT}=30\text{ mA}$ , $-40^\circ\text{C} \leq T_a \leq +85^\circ\text{C}$	—	$\pm 100$	—	ppm/ °C	1	
Current consumption during operation	$I_{SS1}$	$V_{IN}=V_{OUT(S)}+1\text{ V}$ , ON/OFF pin=ON, No load	—	30	40	$\mu\text{A}$	2	
Current consumption during power-off	$I_{SS2}$	$V_{IN}=V_{OUT(S)}+1\text{ V}$ , ON/OFF pin=OFF, No load	—	0.1	0.5	$\mu\text{A}$	2	
Input voltage	$V_{IN}$	—	—	—	10	V	1	
ON/OFF pin input voltage "H"	$V_{SH}$	$V_{IN}=V_{OUT(S)}+1\text{ V}$ , $R_L=1\text{ k}\Omega$ , Judged at $V_{OUT}$ level	1.5	—	—	V	4	
ON/OFF pin input voltage "L"	$V_{SL}$	$V_{IN}=V_{OUT(S)}+1\text{ V}$ , $R_L=1\text{ k}\Omega$ , Judged at $V_{OUT}$ level	—	—	0.3	V	4	
ON/OFF pin input current "H"	$I_{SH}$	$V_{IN}=V_{OUT(S)}+1\text{ V}$ , $V_{ON/OFF}=7\text{ V}$	-0.1	—	0.1	$\mu\text{A}$	4	
ON/OFF pin input current "L"	$I_{SL}$	$V_{IN}=V_{OUT(S)}+1\text{ V}$ , $V_{ON/OFF}=0\text{ V}$	-0.1	—	0.1	$\mu\text{A}$	4	
Short current limit	$I_{OS}$	$V_{IN}=V_{OUT(S)}+1\text{ V}$ , $V_{OUT}$ pin=0 V	—	70	—	mA	3	
Ripple rejection	$ RR $	$V_{IN}=V_{OUT(S)}+1\text{ V}$ , $f=100\text{ Hz}$ , $\Delta V_{rip}=0.5\text{ V}_{rms}$ , $I_{OUT}=30\text{ mA}$	—	45	—	dB	5	

\*1.  $V_{OUT(S)}$ : Set output voltage

$V_{OUT(E)}$ : Actual output voltage

Output voltage when fixing  $I_{OUT}(=30\text{ mA})$  and inputting  $V_{OUT(S)}+1.0\text{ V}$

\*2. The output current at which the output voltage becomes 95% of  $V_{OUT(E)}$  after gradually increasing the output current.

\*3. The output current can be at least this value.  
Use load amperage not exceeding this value.

\*4.  $V_{\text{drop}} = V_{\text{IN1}} - (V_{\text{OUT(E)}} \times 0.98)$

\*1.  $V_{\text{IN1}}$  is the input voltage at which the output voltage becomes 98% of  $V_{\text{OUT(E)}}$  after gradually decreasing the input voltage.

\*5. A change in the temperature of the output voltage [mV/°C] is calculated using the following equation.

$$\frac{\Delta V_{\text{OUT}}}{\Delta T_a} [\text{mV}/^\circ\text{C}]^*1 = V_{\text{OUT(S)}} [\text{V}]^*2 \times \frac{\Delta V_{\text{OUT}}}{\Delta T_a \bullet V_{\text{OUT}}} [\text{ppm}/^\circ\text{C}]^*3 \div 1000$$

\*1. Change in temperature of output voltage

\*2. Set output voltage

\*3. Output voltage temperature coefficient



■ Test Circuits



Figure 5



Figure 6



Figure 7



Figure 8



Figure 9

## ■ Standard Circuit



\*1.  $C_{IN}$  is a capacitor used to stabilize input.

\*2. In addition to a tantalum capacitor, a ceramic capacitor of 0.47  $\mu\text{F}$  or more can be used in  $C_L$ .

Figure 10

**Caution** The above connection diagram and constant will not guarantee successful operation. Perform through evaluation using the actual application to set the constant.

## ■ Explanation of Terms

### 1. Low dropout voltage regulator

This voltage regulator has the low dropout voltage due to its built-in low on-resistance transistor.

### 2. Low ESR

ESR is the abbreviation for Equivalent Series Resistance. The low ESR output capacitor ( $C_L$ ) can be used in the S-814 Series.

### 3. Output voltage ( $V_{OUT}$ )

The accuracy of the output voltage is ensured at  $\pm 2.0\%$  under the specified conditions\*1 of input voltage, output current, and temperature, which differ depending upon the product items.

\*1. The condition differs depending upon each product.

**Caution** If you change the above conditions, the output voltage value may vary out of the accuracy range of the output voltage. Refer to “■ Electrical Characteristics” and “■ Characteristics (Typical Data)” for details.

### 4. Line regulation 1 ( $\Delta V_{OUT1}$ ) and Line regulation 2 ( $\Delta V_{OUT2}$ )

Indicates the input voltage dependencies of output voltage. That is, the value shows how much the output voltage changes due to a change in the input voltage with the output current remained unchanged.

### 5. Load regulation ( $\Delta V_{OUT3}$ )

Indicates the output current dependencies of output voltage. That is, the value shows how much the output voltage changes due to a change in the output current with the input voltage remained unchanged.

**6. Dropout voltage ( $V_{drop}$ )**

Indicates the difference between input voltage ( $V_{IN1}$ ) and the output voltage when; decreasing input voltage ( $V_{IN}$ ) gradually until the output voltage has dropped out to the value of 98% of the actual output voltage ( $V_{OUT(E)}$ ).

$$V_{drop} = V_{IN1} - (V_{OUT(E)} \times 0.98)$$

**7. Output voltage temperature coefficient  $\left( \frac{\Delta V_{OUT}}{\Delta T_a \bullet V_{OUT}} \right)$**

The shaded area in **Figure 11** is the range where  $V_{OUT}$  varies in the operation temperature range when the output voltage temperature coefficient is  $\pm 100$  ppm/ $^{\circ}C$ .



\*1.  $V_{OUT(E)}$  is the value of the output voltage measured at  $T_a = +25^{\circ}C$ .

**Figure 11**

A change in the temperature of the output voltage [ $mV/^{\circ}C$ ] is calculated using the following equation.

$$\frac{\Delta V_{OUT}}{\Delta T_a} [mV / ^{\circ}C]^{*1} = V_{OUT(S)}[V]^{*2} \times \frac{\Delta V_{OUT}}{\Delta T_a \bullet V_{OUT}} [ppm / ^{\circ}C]^{*3} \div 1000$$

- \*1. Change in temperature of output voltage
- \*2. Set output voltage
- \*3. Output voltage temperature coefficient

■ **Operation**

**1. Basic operation**

**Figure 12** shows the block diagram of the S-814 Series.

The error amplifier compares the reference voltage ( $V_{ref}$ ) with feedback voltage ( $V_{fb}$ ), which is the output voltage resistance-divided by feedback resistors ( $R_s$  and  $R_f$ ). It supplies the gate voltage necessary to maintain the constant output voltage which is not influenced by the input voltage and temperature change, to the output transistor.



\*1. Parasitic diode

**Figure 12**

**2. Output transistor**

In the S-814 Series, a low on-resistance P-channel MOS FET is used as the output transistor.

Be sure that  $V_{OUT}$  does not exceed  $V_{IN}+0.3$  V to prevent the voltage regulator from being damaged due to reverse current flowing from VOUT pin through a parasitic diode to VIN pin, when the potential of  $V_{OUT}$  became higher than  $V_{IN}$ .

### 3. ON/OFF pin

This pin starts and stops the regulator.

When the ON/OFF pin is set to OFF level, the entire internal circuit stops operating, and the built-in P-channel MOS FET output transistor between VIN pin and VOUT pin is turned off, reducing current consumption significantly. The VOUT pin enters the VSS level due to internally divided resistance of several MΩ between VOUT pin and VSS pin.

Furthermore, the structure of the ON/OFF pin is as shown in **Figure 13**. Since the ON/OFF pin is neither pulled down nor pulled up internally, do not use it in the floating status. In addition, please note that current consumption increases if a voltage of 0.3 V to  $V_{IN}-0.3$  V is applied to the ON/OFF pin. When not using the ON/OFF pin, connect it to the VIN pin in case of the product A type, connect it to the VSS pin in B type.



**Figure 13**

**Table 6**

Product type	ON/OFF pin	Internal circuit	VOUT pin voltage	Current consumption
A	“H”: ON	Operate	Set value	$I_{SS1}$
A	“L”: OFF	Stop	$V_{SS}$ level	$I_{SS2}$
B	“H”: OFF	Stop	$V_{SS}$ level	$I_{SS2}$
B	“L”: ON	Operate	Set value	$I_{SS1}$

### 4. Short-circuit protection circuit

The S-814 Series incorporates a short-circuit protection circuit to protect the output transistor against short-circuiting between VOUT pin and VSS pin.

The short-circuit protection circuit controls output current as shown in “**1. Output voltage ( $V_{OUT}$ ) vs. Output current ( $I_{OUT}$ ) (When load current increases)**” in “**■ Characteristics (Typical Data)**”, and prevents output current of approx. 70 mA or more from flowing even if VOUT pin and VSS pin are shorted. However, the short-circuit protection circuit does not protect thermal shutdown. Be sure that input voltage and load current do not exceed the specified power dissipation level.

When output current is large and a difference between input and output voltages is large even if not shorted, the short-circuit protection circuit may start functioning and the output current may be controlled to the specified amperage. For details, refer to “**3. Maximum output current ( $I_{OUTmax}$ ) vs. Input voltage ( $V_{IN}$ )**” in “**■ Characteristics (Typical Data)**”.

## ■ Selection of Output Capacitor ( $C_L$ )

Mount an output capacitor between VOUT pin and VSS pin for phase compensation. The S-814 Series enables customers to use a ceramic capacitor as well as a tantalum or an aluminum electrolytic capacitor.

- A ceramic capacitor or an OS capacitor:  
Use a capacitor of 0.47  $\mu$ F or more.
- A tantalum or an aluminum electrolytic capacitor:  
Use a capacitor of 0.47  $\mu$ F or more and ESR of 10  $\Omega$  or less.

Pay special attention not to cause an oscillation due to an increase in ESR at low temperatures, when you use the aluminum electrolytic capacitor. Evaluate the capacitor taking into consideration its performance including temperature characteristics.

Overshoot and undershoot characteristics differ depending upon the type of the output capacitor you select. Refer to  $C_L$  dependencies of "1. Transient Response Characteristics (S-814A30A, Typical data,  $T_a=25^\circ\text{C}$ )" in "■ Reference Data".

## ■ Precautions

- Wiring patterns for the VIN pin, the VOUT pin and GND should be designed so that the impedance is low. When mounting an output capacitor between the VOUT pin and the VSS pin ( $C_L$ ) and a capacitor for stabilizing the input between the VIN pin and the VSS pin ( $C_{IN}$ ), the distance from the capacitors to these pins should be as short as possible.
- Note that generally the output voltage may increase when a series regulator is used at low load current (10  $\mu$ A or less).
- Generally a series regulator may cause oscillation, depending on the selection of external parts. The following conditions are recommended for the S-814 Series. However, be sure to perform sufficient evaluation under the actual usage conditions for selection, including evaluation of temperature characteristics.

Output capacitor ( $C_L$ ):	0.47 $\mu$ F or more
Equivalent Series Resistance (ESR):	10 $\Omega$ or less
Input series resistance ( $R_{IN}$ ):	10 $\Omega$ or less

- The voltage regulator may oscillate when the impedance of the power supply is high and the input capacitance is small or an input capacitor is not connected.
- Overshoot may occur in the output voltage momentarily if the voltage is rapidly raised at power-on or when the power supply fluctuates. Sufficiently evaluate the output voltage at power-on with the actual device.
- The application conditions for the input voltage, the output voltage, and the load current should not exceed the package power dissipation.
- In determining the output current, attention should be paid to the output current value specified in **Table 5** in "■ Electrical Characteristics" and footnote \*3 of the table.
- Do not apply an electrostatic discharge to this IC that exceeds the performance ratings of the built-in electrostatic protection circuit.
- ABLIC Inc. claims no responsibility for any disputes arising out of or in connection with any infringement by products including this IC of patents owned by a third party.

■ Characteristics (Typical data)

1. Output voltage ( $V_{OUT}$ ) vs. Output current ( $I_{OUT}$ ) (When load current increases)

S-814A20A



S-814A30A



S-814A50A



**Remark** In determining the output current, attention should be paid to the following.

1. The minimum output current value and footnote \*3 in Table 5 in "■ Electrical Characteristics".
2. The package power dissipation.

2. Output voltage ( $V_{OUT}$ ) vs. Input voltage ( $V_{IN}$ )

S-814A20A ( $T_a = 25^\circ\text{C}$ )



S-814A30A ( $T_a = 25^\circ\text{C}$ )



S-814A50A ( $T_a = 25^\circ\text{C}$ )



**3. Maximum output current ( $I_{OUTmax}$ ) vs. Input voltage ( $V_{IN}$ )**

S-814A20A

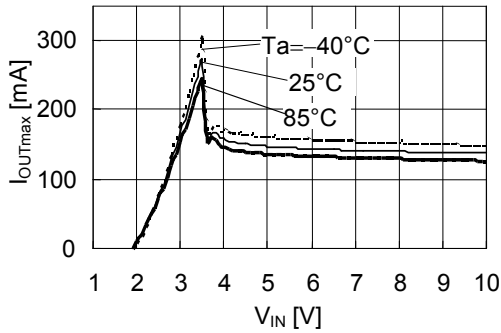

S-814A30A

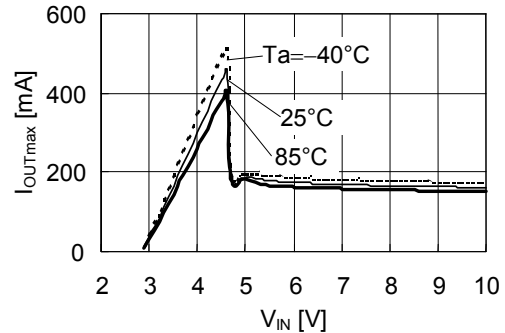

S-814A50A

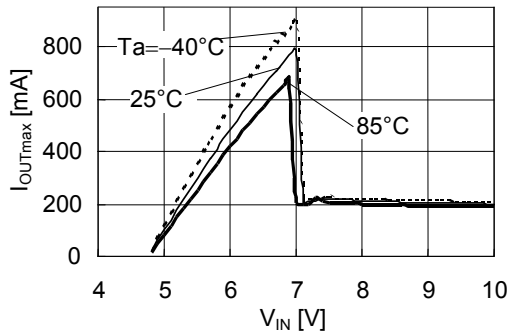

**Remark** In determining the output current, attention should be paid to the following.

1. The minimum output current value and footnote \*3 in Table 5 in “■ Electrical Characteristics”.
2. The package power dissipation.

**4. Dropout voltage ( $V_{drop}$ ) vs. Output current ( $I_{OUT}$ )**

S-814A20A

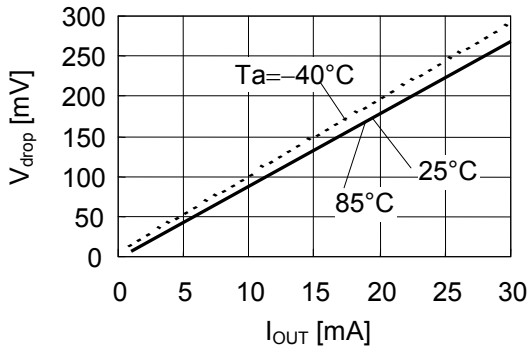

S-814A30A

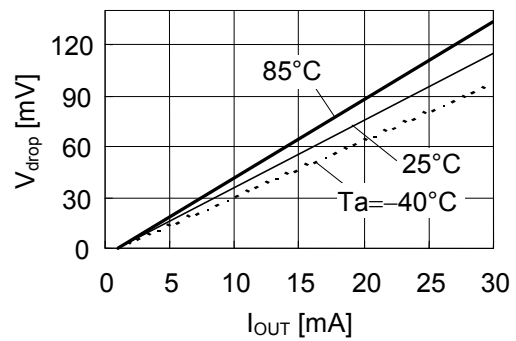

S-814A50A

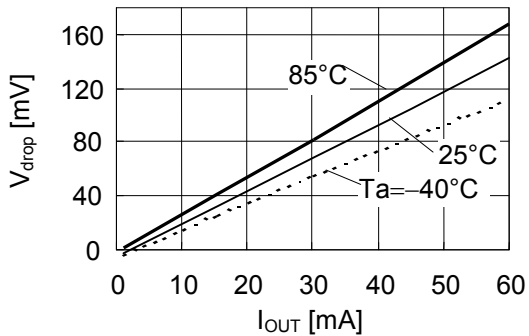



**5. Output voltage ( $V_{OUT}$ ) vs. Ambient temperature ( $T_a$ )**

S-814A20A



S-814A30A

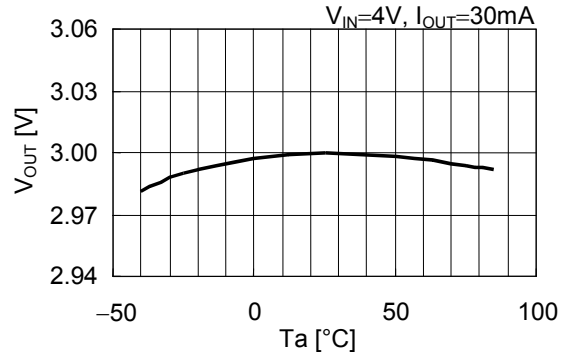

S-814A50A



**6. Line regulation ( $\Delta V_{OUT1}$ ) vs. Ambient temperature ( $T_a$ )**

S-814A20A/S-814A30A/S-814A50A

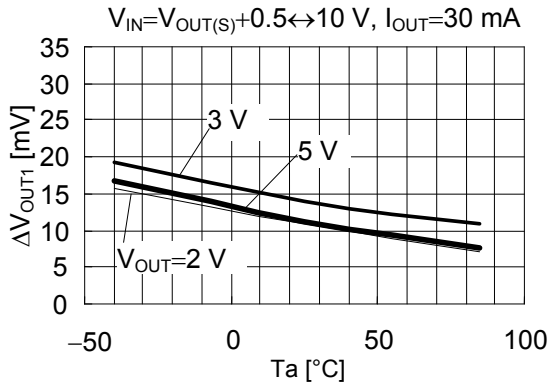

**7. Load regulation ( $\Delta V_{OUT3}$ ) vs. Ambient temperature ( $T_a$ )**

S-814A20A/S-814A30A/S-814A50A

$V_{IN}=V_{OUT(S)}+1\text{ V}$ ,  $I_{OUT}=10\ \mu\text{A}\leftrightarrow 80\text{ mA}$

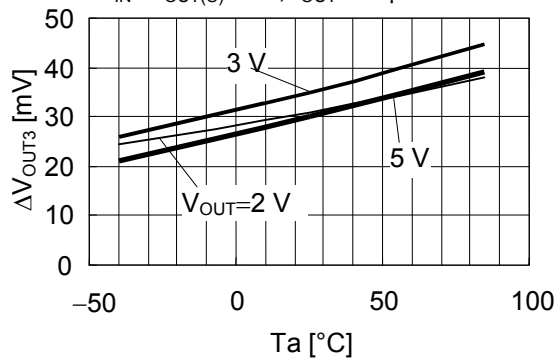

**8. Current consumption ( $\Delta I_{SS1}$ ) vs. Input voltage ( $V_{IN}$ )**

S-814A20A

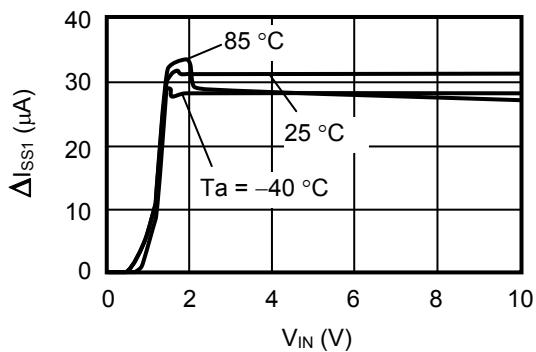

S-814A30A

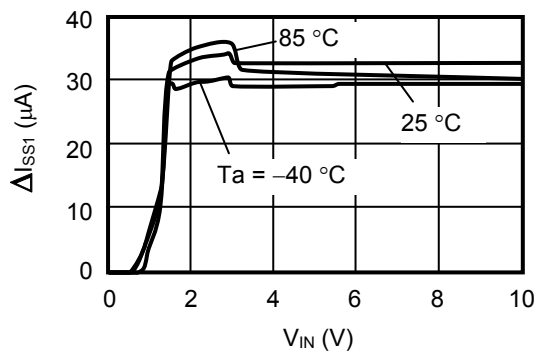

S-814A50A

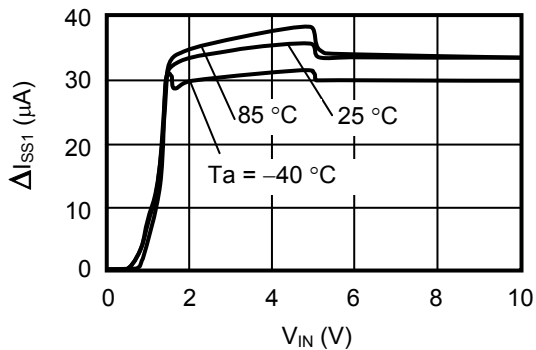

9. Threshold voltage of ON/OFF pin ( $V_{SH}/V_{SL}$ ) vs. Input voltage ( $V_{IN}$ )

S-814A20A



S-814A30A



S-814A50A

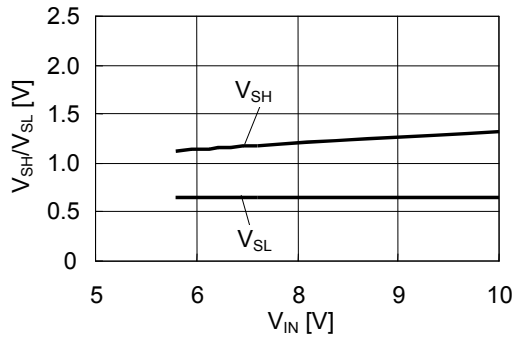

■ **Reference Data**

**1. Transient Response Characteristics (S-814A30A, Typical data, Ta=25°C)**

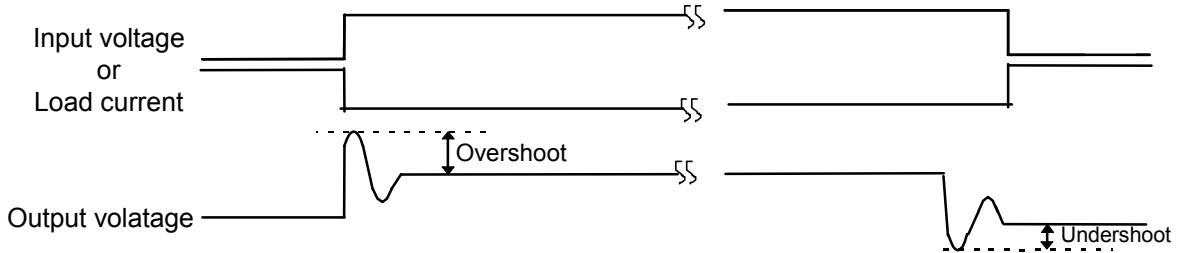

**1-1. At power on**

Output voltage ( $V_{OUT}$ ) – Time ( $t$ )

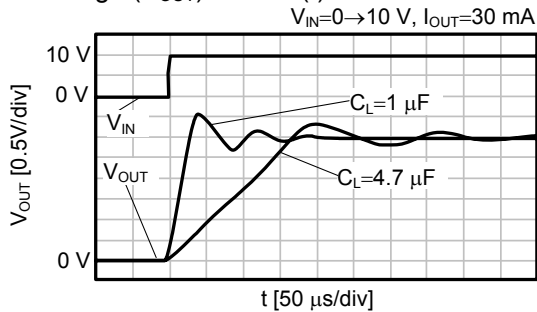

Load dependencies of overshoot

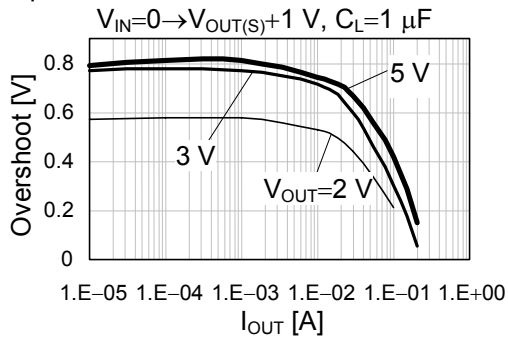

$C_L$  dependencies of overshoot

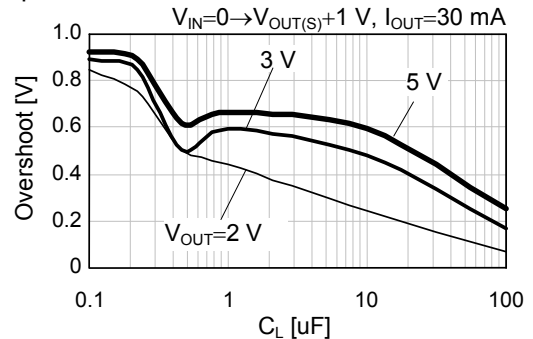

$V_{DD}$  dependencies of overshoot

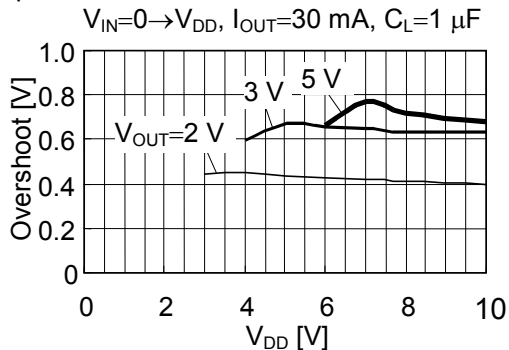

Temperature dependencies of overshoot

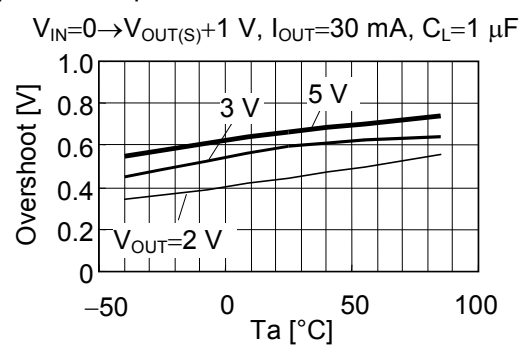

1-2. At power ON/OFF control

Output voltage ( $V_{OUT}$ ) – Time (t)

$V_{IN}=10\text{ V}$ , ON/OFF=0→10 V,  $I_{OUT}=30\text{ mA}$

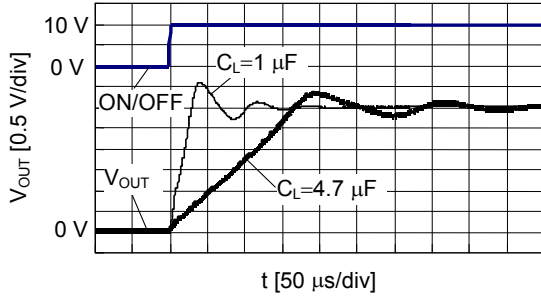

Load dependencies of overshoot

$V_{IN}=V_{OUT(S)}+1\text{ V}$ ,  $C_L=1\text{ μF}$ , ON/OFF=0→ $V_{OUT(S)}+1\text{ V}$



$C_L$  dependencies of overshoot

$V_{IN}=V_{OUT(S)}+1\text{ V}$ ,  $I_{OUT}=30\text{ mA}$ , ON/OFF=0→ $V_{OUT(S)}+1\text{ V}$

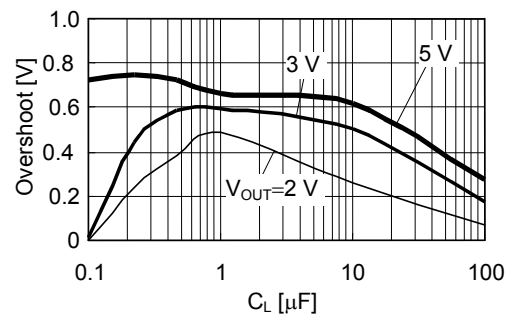

$V_{DD}$  dependencies of overshoot

$V_{IN}=V_{DD}$ ,  $I_{OUT}=30\text{ mA}$ ,  $C_L=1\text{ μF}$ , ON/OFF=0→ $V_{DD}$

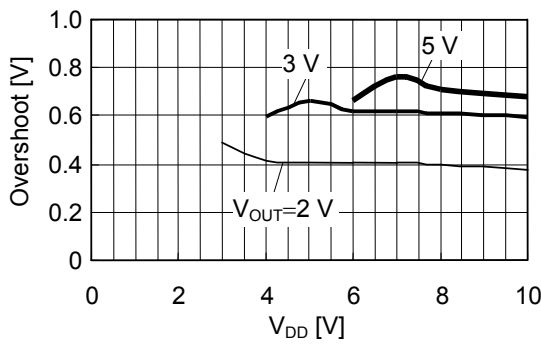

Temperature dependencies of overshoot

$V_{IN}=V_{OUT(S)}+1\text{ V}$ ,  $I_{OUT}=30\text{ mA}$ ,  $C_L=1\text{ μF}$ , ON/OFF=0→ $V_{OUT(S)}+1\text{ V}$

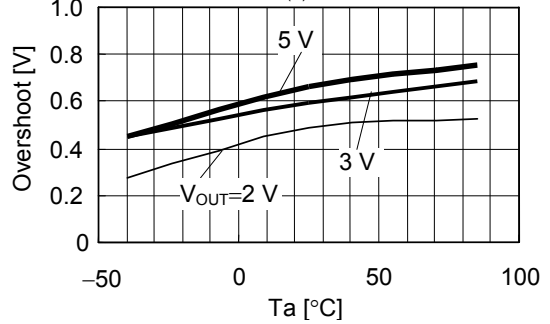

**1-3. At power fluctuation**

Output voltage ( $V_{OUT}$ ) – Time ( $t$ )



Load dependencies of overshoot

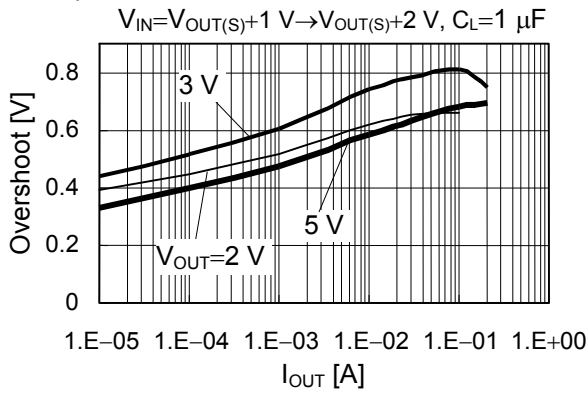

$C_L$  dependencies of overshoot

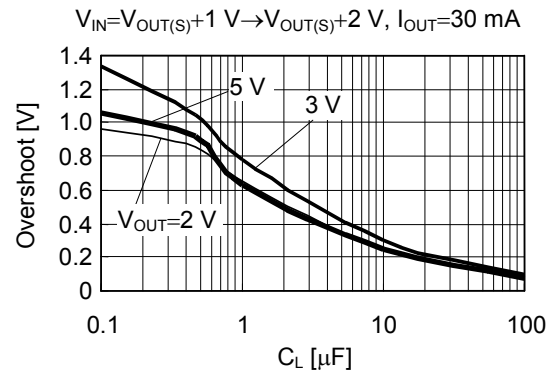

$V_{DD}$  dependencies of overshoot

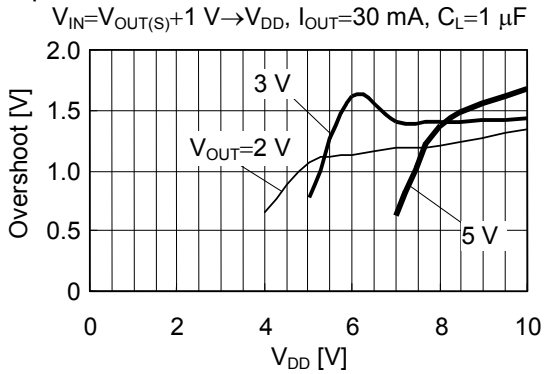

Temperature dependencies of overshoot

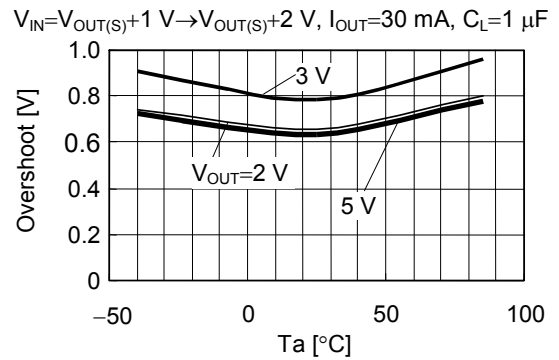

Load dependencies of undershoot

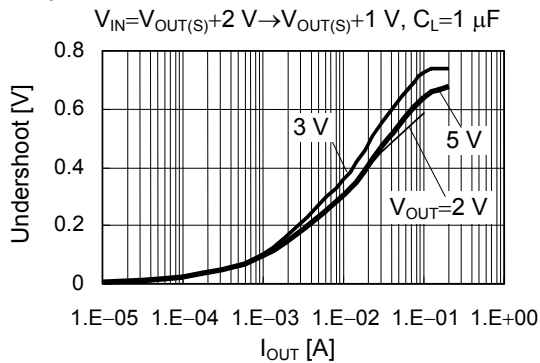

$C_L$  dependencies of undershoot

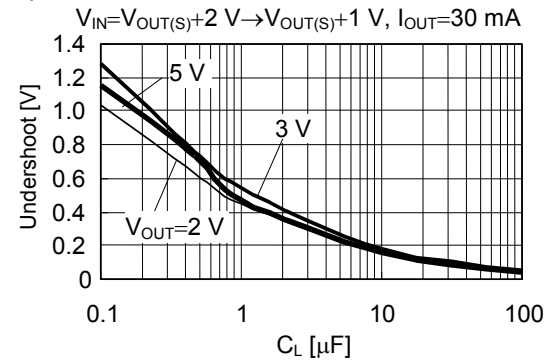

$V_{DD}$  dependencies of undershoot

$V_{IN}=V_{DD} \rightarrow V_{OUT(S)}+1\text{ V}$ ,  $I_{OUT}=30\text{ mA}$ ,  $C_L=1\text{ }\mu\text{F}$



Temperature dependencies of undershoot

$V_{IN}=V_{OUT(S)}+2\text{ V} \rightarrow V_{OUT(S)}+1\text{ V}$ ,  $I_{OUT}=30\text{ mA}$ ,  $C_L=1\text{ }\mu\text{F}$



**1-4. At load fluctuation**

Output voltage ( $V_{OUT}$ ) – Time (t)



Load current dependencies of overshoot



$C_L$  dependencies of overshoot



**Remark**  $\Delta I_{OUT}$  shows larger load current at load current fluctuation. Smaller current at load current fluctuation is fixed to 10  $\mu$ A.  
 i.e.  $\Delta I_{OUT} = 1.E-02$  [A] means load current fluctuation from 10 mA to 10  $\mu$ A.

$V_{DD}$  dependencies of overshoot

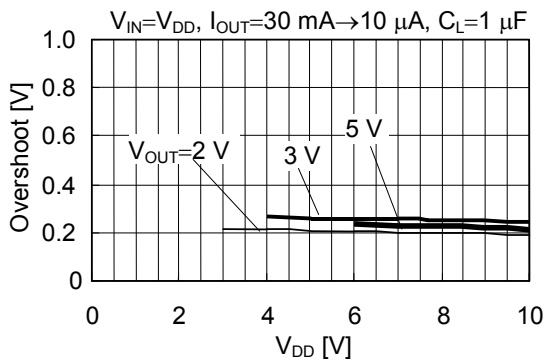

Temperature dependencies of overshoot





Load current dependencies of undershoot



$C_L$  dependence of undershoot



**Remark**  $\Delta I_{OUT}$  shows larger load current at load current fluctuation. Lower current at load current fluctuation is fixed to 10  $\mu\text{A}$ .  
i.e.  $\Delta I_{OUT}=1.E-02$  [A] means load current fluctuation from 10  $\mu\text{A}$  to 10 mA.

$V_{DD}$  dependencies of undershoot



Temperature dependencies of undershoot



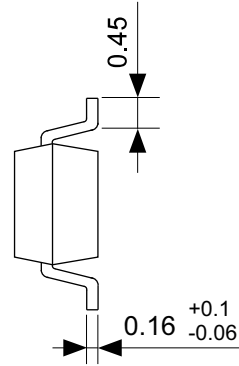

No. MP005-A-P-SD-1.3

TITLE	SOT235-A-PKG Dimensions
No.	MP005-A-P-SD-1.3
ANGLE	
UNIT	mm
<b>ABLIC Inc.</b>	



→ Feed direction

No. MP005-A-C-SD-2.1

TITLE	SOT235-A-Carrier Tape
No.	MP005-A-C-SD-2.1
ANGLE	
UNIT	mm
<b>ABLIC Inc.</b>	



Enlarged drawing in the central part



No. MP005-A-R-SD-1.1

TITLE	SOT235-A-Reel		
No.	MP005-A-R-SD-1.1		
ANGLE		QTY.	3,000
UNIT	mm		
<b>ABLIC Inc.</b>			



No. UP005-A-P-SD-2.0

TITLE	SOT895-A-PKG Dimensions
No.	UP005-A-P-SD-2.0
ANGLE	
UNIT	mm
<b>ABLIC Inc.</b>	



→  
Feed direction

No. UP005-A-C-SD-2.0

TITLE	SOT895-A-Carrier Tape
No.	UP005-A-C-SD-2.0
ANGLE	
UNIT	mm
<b>ABLIC Inc.</b>	



Enlarged drawing in the central part



No. UP005-A-R-SD-1.1

TITLE	SOT895-A-Reel		
No.	UP005-A-R-SD-1.1		
ANGLE		QTY.	1,000
UNIT	mm		
<b>ABLIC Inc.</b>			

## Disclaimers (Handling Precautions)

1. All the information described herein (product data, specifications, figures, tables, programs, algorithms and application circuit examples, etc.) is current as of publishing date of this document and is subject to change without notice.
2. The circuit examples and the usages described herein are for reference only, and do not guarantee the success of any specific mass-production design.  
ABLIC Inc. is not responsible for damages caused by the reasons other than the products described herein (hereinafter "the products") or infringement of third-party intellectual property right and any other right due to the use of the information described herein.
3. ABLIC Inc. is not responsible for damages caused by the incorrect information described herein.
4. Be careful to use the products within their specified ranges. Pay special attention to the absolute maximum ratings, operation voltage range and electrical characteristics, etc.  
ABLIC Inc. is not responsible for damages caused by failures and / or accidents, etc. that occur due to the use of the products outside their specified ranges.
5. When using the products, confirm their applications, and the laws and regulations of the region or country where they are used and verify suitability, safety and other factors for the intended use.
6. When exporting the products, comply with the Foreign Exchange and Foreign Trade Act and all other export-related laws, and follow the required procedures.
7. The products must not be used or provided (exported) for the purposes of the development of weapons of mass destruction or military use. ABLIC Inc. is not responsible for any provision (export) to those whose purpose is to develop, manufacture, use or store nuclear, biological or chemical weapons, missiles, or other military use.
8. The products are not designed to be used as part of any device or equipment that may affect the human body, human life, or assets (such as medical equipment, disaster prevention systems, security systems, combustion control systems, infrastructure control systems, vehicle equipment, traffic systems, in-vehicle equipment, aviation equipment, aerospace equipment, and nuclear-related equipment), excluding when specified for in-vehicle use or other uses. Do not apply the products to the above listed devices and equipments without prior written permission by ABLIC Inc. Especially, the products cannot be used for life support devices, devices implanted in the human body and devices that directly affect human life, etc.  
Prior consultation with our sales office is required when considering the above uses.  
ABLIC Inc. is not responsible for damages caused by unauthorized or unspecified use of our products.
9. Semiconductor products may fail or malfunction with some probability.  
The user of the products should therefore take responsibility to give thorough consideration to safety design including redundancy, fire spread prevention measures, and malfunction prevention to prevent accidents causing injury or death, fires and social damage, etc. that may ensue from the products' failure or malfunction.  
The entire system must be sufficiently evaluated and applied on customer's own responsibility.
10. The products are not designed to be radiation-proof. The necessary radiation measures should be taken in the product design by the customer depending on the intended use.
11. The products do not affect human health under normal use. However, they contain chemical substances and heavy metals and should therefore not be put in the mouth. The fracture surfaces of wafers and chips may be sharp. Be careful when handling these with the bare hands to prevent injuries, etc.
12. When disposing of the products, comply with the laws and ordinances of the country or region where they are used.
13. The information described herein contains copyright information and know-how of ABLIC Inc.  
The information described herein does not convey any license under any intellectual property rights or any other rights belonging to ABLIC Inc. or a third party. Reproduction or copying of the information from this document or any part of this document described herein for the purpose of disclosing it to a third-party without the express permission of ABLIC Inc. is strictly prohibited.
14. For more details on the information described herein, contact our sales office.

2.2-2018.06



# Mouser Electronics

Authorized Distributor

Click to View Pricing, Inventory, Delivery & Lifecycle Information:

## ABLIC:

[S-814A42AMC-BDGT2G](#) [S-814A32AMC-BCWT2G](#) [S-814A33AUC-BCXT2G](#) [S-814A28AUC-BCST2G](#) [S-814A38AUC-BDCT2G](#) [S-814A36AMC-BDAT2G](#) [S-814A46AMC-BDKT2G](#) [S-814A26AMC-BCQT2G](#) [S-814A26AUC-BCQT2G](#) [S-814A20AUC-BCKT2G](#) [S-814A40AUC-BDET2G](#) [S-814A30AUC-BCUT2G](#) [S-814A50AUC-BDOT2G](#) [S-814A21AMC-BCLT2G](#) [S-814A21AUC-BCLT2G](#) [S-814A22AMC-BCMT2G](#) [S-814A23AMC-BCNT2G](#) [S-814A23AUC-BCNT2G](#) [S-814A27AUC-BCRT2G](#) [S-814A29AMC-BCTT2G](#) [S-814A29AUC-BCTT2G](#) [S-814A34AUC-BCYT2G](#) [S-814A35AUC-BCZT2G](#) [S-814A36AUC-BDAT2G](#) [S-814A37AUC-BDBT2G](#) [S-814A39AMC-BDDT2G](#) [S-814A39AUC-BDDT2G](#) [S-814A41AUC-BDFT2G](#) [S-814A42AUC-BDGT2G](#) [S-814A43AMC-BDHT2G](#) [S-814A43AUC-BDHT2G](#) [S-814A44AMC-BDIT2G](#) [S-814A44AUC-BDIT2G](#) [S-814A45AMC-BDJT2G](#) [S-814A45AUC-BDJT2G](#) [S-814A46AUC-BDKT2G](#) [S-814A47AMC-BDLT2G](#) [S-814A47AUC-BDLT2G](#) [S-814A48AMC-BDMT2G](#) [S-814A48AUC-BDMT2G](#) [S-814A49AMC-BDNT2G](#) [S-814A49AUC-BDNT2G](#) [S-814A51AMC-BDPT2G](#) [S-814A51AUC-BDPT2G](#) [S-814A52AMC-BDQT2G](#) [S-814A52AUC-BDQT2G](#) [S-814A53AMC-BDRT2G](#) [S-814A53AUC-BDRT2G](#) [S-814A54AMC-BDST2G](#) [S-814A54AUC-BDST2G](#) [S-814A55AMC-BDTT2G](#) [S-814A55AUC-BDTT2G](#) [S-814A56AMC-BDUT2G](#) [S-814A56AUC-BDUT2G](#) [S-814A57AMC-BDVT2G](#) [S-814A57AUC-BDVT2G](#) [S-814A58AMC-BDWT2G](#) [S-814A58AUC-BDWT2G](#) [S-814A59AMC-BDXT2G](#) [S-814A59AUC-BDXT2G](#) [S-814A60AMC-BDYT2G](#) [S-814A60AUC-BDYT2G](#) [S-814A50AMC-BDOT2G](#) [S-814A30AMC-BCUT2G](#) [S-814A20AMC-BCKT2G](#) [S-814A40AMC-BDET2G](#) [S-814A31AUC-BCVT2G](#) [S-814A24AMC-BCOT2G](#) [S-814A34AMC-BCYT2G](#) [S-814A25AUC-BCPT2G](#) [S-814A22AUC-BCMT2G](#) [S-814A32AUC-BCWT2G](#) [S-814A35AMC-BCZT2G](#) [S-814A25AMC-BCPT2G](#) [S-814A38AMC-BDCT2G](#) [S-814A28AMC-BCST2G](#) [S-814A41AMC-BDFT2G](#) [S-814A31AMC-BCVT2G](#) [S-814A33AMC-BCXT2G](#) [S-814A24AUC-BCOT2G](#) [S-814A37AMC-BDBT2G](#) [S-814A27AMC-BCRT2G](#) [S-814A50AMC-BDOT2U](#)

Компания «Океан Электроники» предлагает заключение долгосрочных отношений при поставках импортных электронных компонентов на взаимовыгодных условиях!

Наши преимущества:

- Поставка оригинальных импортных электронных компонентов напрямую с производств Америки, Европы и Азии, а так же с крупнейших складов мира;
- Широкая линейка поставок активных и пассивных импортных электронных компонентов (более 30 млн. наименований);
- Поставка сложных, дефицитных, либо снятых с производства позиций;
- Оперативные сроки поставки под заказ (от 5 рабочих дней);
- Экспресс доставка в любую точку России;
- Помощь Конструкторского Отдела и консультации квалифицированных инженеров;
- Техническая поддержка проекта, помощь в подборе аналогов, поставка прототипов;
- Поставка электронных компонентов под контролем ВП;
- Система менеджмента качества сертифицирована по Международному стандарту ISO 9001;
- При необходимости вся продукция военного и аэрокосмического назначения проходит испытания и сертификацию в лаборатории (по согласованию с заказчиком);
- Поставка специализированных компонентов военного и аэрокосмического уровня качества (Xilinx, Altera, Analog Devices, Intersil, Interpoint, Microsemi, Actel, Aeroflex, Peregrine, VPT, Syfer, Eurofarad, Texas Instruments, MS Kennedy, Miteq, Cobham, E2V, MA-COM, Hittite, Mini-Circuits, General Dynamics и др.);

Компания «Океан Электроники» является официальным дистрибьютором и эксклюзивным представителем в России одного из крупнейших производителей разъемов военного и аэрокосмического назначения «JONHON», а так же официальным дистрибьютором и эксклюзивным представителем в России производителя высокотехнологичных и надежных решений для передачи СВЧ сигналов «FORSTAR».



## JONHON

«JONHON» (основан в 1970 г.)

Разъемы специального, военного и аэрокосмического назначения:

(Применяются в военной, авиационной, аэрокосмической, морской, железнодорожной, горно- и нефтедобывающей отраслях промышленности)

«FORSTAR» (основан в 1998 г.)

ВЧ соединители, коаксиальные кабели, кабельные сборки и микроволновые компоненты:

(Применяются в телекоммуникациях гражданского и специального назначения, в средствах связи, РЛС, а так же военной, авиационной и аэрокосмической отраслях промышленности).



Телефон: 8 (812) 309-75-97 (многоканальный)

Факс: 8 (812) 320-03-32

Электронная почта: [ocean@oceanchips.ru](mailto:ocean@oceanchips.ru)

Web: <http://oceanchips.ru/>

Адрес: 198099, г. Санкт-Петербург, ул. Калинина, д. 2, корп. 4, лит. А