



- ⊗ IP68 rating tested at 1.054kg/sq cm (15lb/sq in) 10m depth for 2 weeks
- ⊗ IP69K, Tested in accordance with DIN 40050/Part 9 IP6k9k
- ⊗ 32A, 600V ac/dc rating
- ⊗ 2, 3, 4, 5, 7 and 10 pole
- ⊗ Plug or socket connection in each body style
- ⊗ Water and dustproof to IP68 when mated
- ⊗ 'Scoop proof' contacts
- ⊗ Field termination - screw terminations
- ⊗ Positive locating keyways - cannot be mis-connected
- ⊗ Sealing caps available to maintain IP68 rating of unmated connectors
- ⊗ Leading earth contact for 3, 4, 5 and 7 pole versions
- ⊗ EN60068-2-52 Test Kb Salt Mist (Cyclic) Marine Severity Level 1
- ⊗ Trailing Neutral on 5 pole
- ⊗ Compact design
- ⊗ Easy assembly - no special tools required
- ⊗ Single or 3 phase applications
- ⊗ Bulkhead moulding available for use with flange mounting body for 45° or 90° mounting (order each separately)
- ⊗ Cost effective solution
- ⊗ Cable accommodation 7-22mm O/D
- ⊗ Two cable connector versions for 15mm and 22mm (maximum) cable diameters
- ⊗ Separate strain relief on large cable version
- ⊗ CCC, UL, CSA and VDE approvals

Flex Cable Connector



PX0911

Flex Cable Connector



PXA911

- Mates with in-line flex or panel mounting versions
- Positive, fast acting locking ring - can be turned with a gloved hand
- Plug or socket versions
- PX0 Series 13-15mm cable dia. as standard, 7-13mm with additional gland pack
- PXA Series 20-22mm cable dia. as standard, 14-20mm with additional gland pack
- Strain Relief Clamp

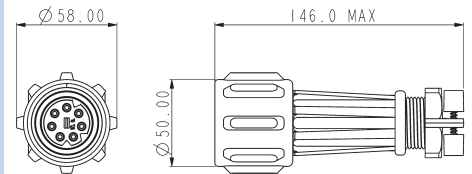
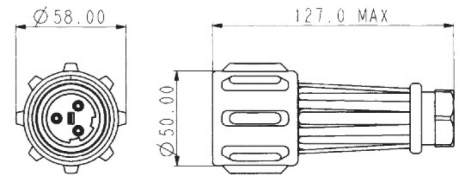

Standard Cable	Large Cable	Description	Standard Cable	Large Cable	Description
PX0911/02/P	PXA911/02/P	2 pole Plug	PX0911/02/S	PXA911/02/S	2 pole Socket
PX0911/03/P	PXA911/03/P	3 pole Plug	PX0911/03/S	PXA911/03/S	3 pole Socket
PX0911/04/P	PXA911/04/P	4 pole Plug	PX0911/04/S	PXA911/04/S	4 pole Socket
PX0911/05/P	PXA911/05/P	5 pole Plug	PX0911/05/S	PXA911/05/S	5 pole Socket
PX0911/07/P	PXA911/07/P	7 pole Plug	PX0911/07/S	PXA911/07/S	7 pole Socket
PX0911/10/P	PXA911/10/P	10 pole Plug	PX0911/10/S	PXA911/10/S	10 pole Socket

In-Line Flex Cable Connector



PX0921

In-Line Flex Cable Connector



PXA921

- Mates with either PX0911 or PXA911 connectors
- Plug or socket versions
- PX0 Series 13-15mm cable dia. as standard, 7-13mm with additional gland pack
- PXA Series 20-22mm cable dia. as standard, 14-20mm with additional gland pack
- Strain Relief Clamp

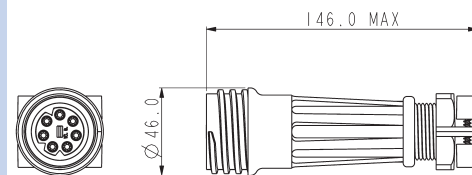
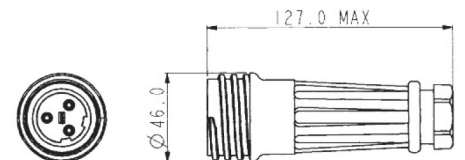

Standard Cable	Large Cable	Description	Standard Cable	Large Cable	Description
PX0921/02/P	PXA921/02/P	2 pole Plug	PX0921/02/S	PXA921/02/S	2 pole Socket
PX0921/03/P	PXA921/03/P	3 pole Plug	PX0921/03/S	PXA921/03/S	3 pole Socket
PX0921/04/P	PXA921/04/P	4 pole Plug	PX0921/04/S	PXA921/04/S	4 pole Socket
PX0921/05/P	PXA921/05/P	5 pole Plug	PX0921/05/S	PXA921/05/S	5 pole Socket
PX0921/07/P	PXA921/07/P	7 pole Plug	PX0921/07/S	PXA921/07/S	7 pole Socket
PX0921/10/P	PXA921/10/P	10 pole Plug	PX0921/10/S	PXA921/10/S	10 pole Socket

Panel Mounted Connector



PX0931

- Mates with PX0911 and PXA911 connectors
- Single hole fixing
- Anti-rotation key
- High grade sealing gasket
- 3-7mm panel thickness

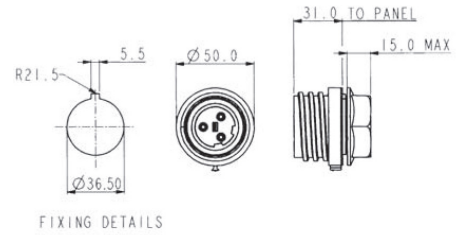

**Panel Mounting**

PX0931/02/P	2 pole Plug	PX0931/02/S	2 pole Socket
PX0931/03/P	3 pole Plug	PX0931/03/S	3 pole Socket
PX0931/04/P	4 pole Plug	PX0931/04/S	4 pole Socket
PX0931/05/P	5 pole Plug	PX0931/05/S	5 pole Socket
PX0931/07/P	7 pole Plug	PX0931/07/S	7 pole Socket
PX0931/10/P	10 pole Plug	PX0931/10/S	10 pole Socket

Flange Mounted Connector



PX0941

- Mates with PX0911 and PXA911 connectors
- Supplied with high grade sealing gasket
- Supplied with sealing grommets for panel fixing screws (M6 thread recommended)

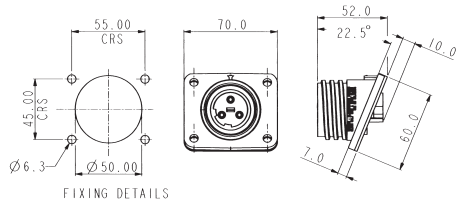

**Flange Mounting**

PX0941/02/P	2 pole Plug	PX0941/02/S	2 pole Socket
PX0941/03/P	3 pole Plug	PX0941/03/S	3 pole Socket
PX0941/04/P	4 pole Plug	PX0941/04/S	4 pole Socket
PX0941/05/P	5 pole Plug	PX0941/05/S	5 pole Socket
PX0941/07/P	7 pole Plug	PX0941/07/S	7 pole Socket
PX0941/10/P	10 pole Plug	PX0941/10/S	10 pole Socket

Additional Bulkhead Adaptor Moulding



PX0950

Additional Bulkhead Adaptor Moulding



PX0950 & PX0941

- For use with flange mounting connector PX0941, to give 45° or 90° angle
- Supplied with high grade sealing gasket
- Supplied with sealing grommets for panel fixing screws (M6 thread recommended)

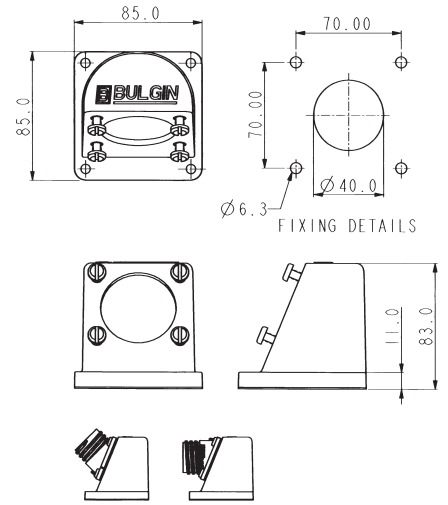

Accessories



PX0960, PX0970

- Sealing caps to maintain IP68 rating of unmounted connectors, with plastic straps

**Sealing Caps**

- PX0960 Sealing cap for use with PX0911/xx/x and PXA911/xx/x
- PX0970 Sealing cap for use with all other styles
- PX0990 Heavy duty sealing cap for use with PX0911/xx/x and PXA911/xx/x
- PX0991 Heavy duty sealing cap for use with PX0921/xx/x and PXA921/xx/x
- PX0992 Heavy duty sealing cap for use with PX0931W and PX0941

Accessories



PX0990, PX0991, PX0992

- Heavy duty sealing caps to maintain IP68 rating of unmounted connectors, with stainless steel straps

**Gland Packs**

- PX0980 Pack of 3 additional cable glands for PX0911 and PX0921 to suit cable sizes; 11-13mm, 9-11 and 7-9mm dia.
- PXA980 Pack of 3 additional cable glands for PXA911 and PXA921 to suit cable sizes; 18-20mm, 16-18 and 14-16mm dia.

Specifications

**Electrical**

No Poles:	2, 3	4, 5	7	10†
Current Rating:	32A 30A, CSA	32A 25A, CSA	32A 25A, CSA*	10A UL
Voltage Rating:	600V ac/dc	600V ac/dc	430V ac/dc	250V ac/dc
Contact Resistance:	<10m Ω (initial)			
Insulation Resistance:	>10 <sup>9</sup> MΩ (@ 500V dc)			
Dielectric strength:	2.2kV ac min			
AC Breakdown voltage:	6kV			
Operating Temperature Range:	-40°C to +85°C			
Approvals:	E214972 1211899 40003148 2011010203500396 – 10 Amp Rated 2011010203500396 – 32 Amp Rated			

\*with 75°C min. rated cable

**Material**

Body Mouldings:	Polyamide
Flammability Rating:	UL94V-0
UV Resistance:	To EN50021: 1999
Contacts:	Machined Solid Brass, Nickel plated
O Rings:	Nitrile
Panel Sealing Gasket:	Silicone Rubber
RoHS	Compliant

**Contact Layout**

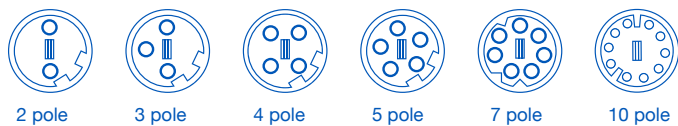

**Dimensions**

Overall dimensions of connectors when mated together

PX0911 + PX0921 230 mm max.  
PXA911 + PXA921 270 mm max.

PX0911 + PX0931 135 mm max. (to panel)  
PXA911 + PX0931 175 mm max. (to panel)

PX0911 + PX0941 145 mm max.  
(to panel, mid point on flange)

PXA911 + PX0941 174 mm max.  
(to panel, mid point on flange)

**Mechanical:**

Sealing:	IP69K, Tested in accordance with DIN 40050/Part 9 IP6K9K. IP68, EN60529:1992+A2:2013 tested @ 1.054kg/sq.cm. (15lb/sq.in.) 10m depth for 2 weeks
Salt Mist:	EN60068-2-52 Test Kb Salt Mist (Cyclic) Marine Severity Level 1
Cable Acceptance:	PX0911-PX0921 13 - 15mm O/D standard, 7-13mm with gland pack PXA911-PXA921 20 - 22mm O/D standard, 14 - 20mm with gland pack
Contact Accommodation:	2-7 pole - 2.5 to 4mm <sup>2</sup> (13 to 10AWG) conductor, single or multi stranded 10 pole - 0.75 to 2mm <sup>2</sup> (14 to 18AWG) conductor, single or multi stranded
Termination:	Axial screw terminals

Cable Retention force:	22mm dia, 150N 15mm dia, 150N 7mm dia, 80N
------------------------	--

Gland Nut Torques:	
PX0 range	
13-15mm (Yellow - std.)	3.16Nm (28 lbf.in.)
11-13mm (black)	3.16Nm (28 lbf.in.)
7-9mm (dark grey)	3.16Nm (28 lbf.in.)
PXA range	
20-22mm (Yellow - std.)	3.16Nm (28 lbf.in.)
18-20mm (black)	3.16Nm (28 lbf.in.)
16-18mm (white)	3.16Nm (28 lbf.in.)
14-16mm (dark grey)	3.16Nm (28 lbf.in.)

Tightening Torques:	
Panel mount nut	2.25Nm (20 lbf.in.)
Flange & Bulkhead fixing screws	0.9Nm (8 lbf.in.)
Inserts into Bodies	1.13Nm (10 lbf.in.) to 1.36Nm (12 lbf.in.)
Term screws - 2 to 5 poles	1.0Nm (9 lbf.in.) max
Term screws - 7 pole	0.4Nm (3.5 lbf.in.) max
Term screws - 10 pole	0.25Nm (2.2 lbf.in.) max

Rear thread PX0931 series M36 x 2-6g



**PX X9                      X                      X                      /                      XX                      /                      X                      /                      XX**

**Series Designation**

09 = Standard Cable Accommodation (7-13mm)

A9 = Large Cable Accommodation (14-22mm)

**Body Styles**

- 1 = Flex
- 2 = Flex In-line
- 3 = Panel
- 4 = Flange Panel

**Contact Termination**

- 1 = Screw Terminal

**Number Contacts**

- 02 = 2 pole
- 03 = 3 pole
- 04 = 4 pole
- 05 = 5 pole
- 07 = 7 pole
- 10 = 10 pole

**Contact Type**

P = Plug, S = Socket

**Cable Acceptance**

**EXP-0 version:**  
 Blank = 13-15mm  
 Yellow cable gland (std)

3 = 11-13mm  
 Black cable gland

2 = 9-11mm  
 White cable gland

1 = 7-9mm  
 Dark Grey cable gland

**EXP-A version:**  
 Blank = 20-22mm  
 Yellow cable gland (std)

9 = 18-20mm  
 Black cable gland

8 = 16-18mm  
 White cable gland

7 = 14-16mm  
 Dark Grey cable gland

**Example:**

PX0911/07/P/03 = Flex cable connector with standard cable accommodation body, seven pin contacts, with gland to suit 11-13mm cable.

Компания «Океан Электроники» предлагает заключение долгосрочных отношений при поставках импортных электронных компонентов на взаимовыгодных условиях!

Наши преимущества:

- Поставка оригинальных импортных электронных компонентов напрямую с производств Америки, Европы и Азии, а так же с крупнейших складов мира;
- Широкая линейка поставок активных и пассивных импортных электронных компонентов (более 30 млн. наименований);
- Поставка сложных, дефицитных, либо снятых с производства позиций;
- Оперативные сроки поставки под заказ (от 5 рабочих дней);
- Экспресс доставка в любую точку России;
- Помощь Конструкторского Отдела и консультации квалифицированных инженеров;
- Техническая поддержка проекта, помощь в подборе аналогов, поставка прототипов;
- Поставка электронных компонентов под контролем ВП;
- Система менеджмента качества сертифицирована по Международному стандарту ISO 9001;
- При необходимости вся продукция военного и аэрокосмического назначения проходит испытания и сертификацию в лаборатории (по согласованию с заказчиком);
- Поставка специализированных компонентов военного и аэрокосмического уровня качества (Xilinx, Altera, Analog Devices, Intersil, Interpoint, Microsemi, Actel, Aeroflex, Peregrine, VPT, Syfer, Eurofarad, Texas Instruments, MS Kennedy, Miteq, Cobham, E2V, MA-COM, Hittite, Mini-Circuits, General Dynamics и др.);

Компания «Океан Электроники» является официальным дистрибьютором и эксклюзивным представителем в России одного из крупнейших производителей разъемов военного и аэрокосмического назначения «JONHON», а так же официальным дистрибьютором и эксклюзивным представителем в России производителя высокотехнологичных и надежных решений для передачи СВЧ сигналов «FORSTAR».



## JONHON

«JONHON» (основан в 1970 г.)

Разъемы специального, военного и аэрокосмического назначения:

(Применяются в военной, авиационной, аэрокосмической, морской, железнодорожной, горно- и нефтедобывающей отраслях промышленности)

«FORSTAR» (основан в 1998 г.)

ВЧ соединители, коаксиальные кабели, кабельные сборки и микроволновые компоненты:

(Применяются в телекоммуникациях гражданского и специального назначения, в средствах связи, РЛС, а так же военной, авиационной и аэрокосмической отраслях промышленности).



Телефон: 8 (812) 309-75-97 (многоканальный)

Факс: 8 (812) 320-03-32

Электронная почта: [ocean@oceanchips.ru](mailto:ocean@oceanchips.ru)

Web: <http://oceanchips.ru/>

Адрес: 198099, г. Санкт-Петербург, ул. Калинина, д. 2, корп. 4, лит. А