

CAT3648

4-Channel Ultra High Efficiency Quad-Mode[®] LED Driver with 32 Dimming Levels

Description

The CAT3648 is a high efficiency quad-mode fractional charge pump that can drive up to four LEDs programmable by a one wire digital interface. The inclusion of a 1.33x fractional charge pump mode increases device efficiency by up to 10% over traditional 1.5x charge pumps with no added external capacitors.

Low noise input ripple is achieved by operating at a constant switching frequency which allows the use of small external ceramic capacitors. The multi-fractional charge pump supports a wide range of input voltages from 2.5 V to 5.5 V.

The EN/DIM logic input functions as a chip enable and a digital dimming interface for setting the current in all LED channels. The 1-wire pulse-dimming interface supports 32 linear steps from full-scale down to zero current.

The device is available in the tiny 16-pad TQFN 3 mm x 3 mm package with a max height of 0.8 mm.

ON Semiconductor's Quad-Mode[®] 1.33x, charge pump switching architecture is patented.

Features

- High Efficiency 1.33x Charge Pump
- Quad-mode Charge Pump: 1x, 1.33x, 1.5x, 2x
- Drives up to 4 LEDs at 25 mA Each
- 1-wire EZDim™ 32 Linear Steps
- Power Efficiency up to 92%
- Low Noise Input Ripple in All Modes
- “Zero” Current Shutdown Mode
- Soft Start and Current Limiting
- Short Circuit Protection
- Thermal Shutdown Protection
- 3 mm x 3 mm, 16-pad TQFN Package
- These Devices are Pb-Free, Halogen Free/BFR Free and are RoHS Compliant

Applications

- LCD Display Backlight
- Cellular Phones
- Digital Still Cameras
- Handheld Devices



ON Semiconductor[®]

<http://onsemi.com>



TQFN-16
HV3 SUFFIX
CASE 510AD

PIN CONNECTIONS

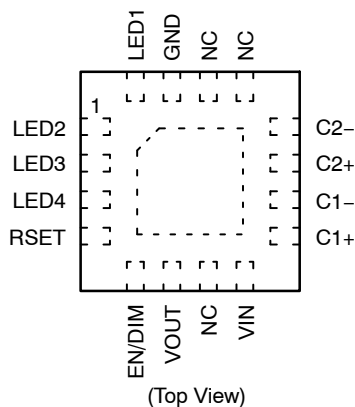

MARKING DIAGRAM



JAAN = CAT3648HV3-GT2
A = Assembly Location
XXX = Last Three Digits of Assembly Lot Number
Y = Production Year (Last Digit)
WW = Production Week (Two Digits)

ORDERING INFORMATION

Device	Package	Shipping
CAT3648HV3-GT2 (Note 1)	TQFN-16 (Pb-Free)	2,000/ Tape & Reel

1. NiPdAu Plated Finish (RoHS-compliant).

CAT3648

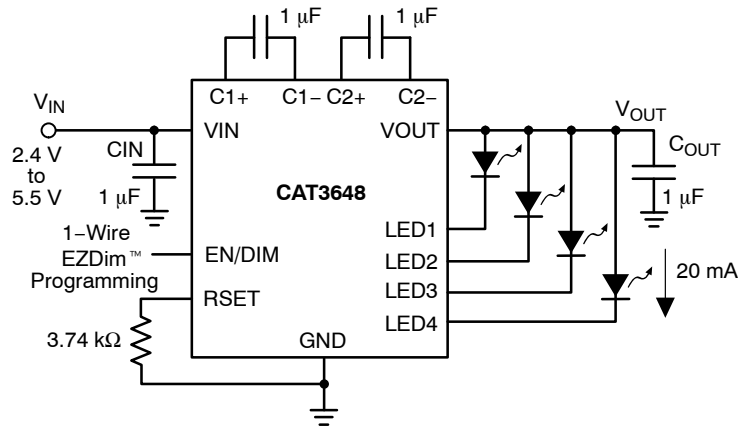

Figure 1. Typical Application Circuit

Table 1. ABSOLUTE MAXIMUM RATINGS

Parameter	Rating	Unit
VIN, LEDx, C1±, C2±, EN/DIM voltage	6	V
VOUT voltage	7	V
Storage Temperature Range	-65 to +160	°C
Junction Temperature Range	-40 to +150	°C

Stresses exceeding Maximum Ratings may damage the device. Maximum Ratings are stress ratings only. Functional operation above the Recommended Operating Conditions is not implied. Extended exposure to stresses above the Recommended Operating Conditions may affect device reliability.

Table 2. RECOMMENDED OPERATING CONDITIONS

Parameter	Rating	Unit
VIN	2.5 to 5.5	V
Ambient Temperature Range	-40 to +85	°C
I _{LED} per LED pin	up to 30	mA
LED Forward Voltage Range	1.3 to 4.3	V

NOTE: Typical application circuit with external components is shown above.

CAT3648

Table 3. ELECTRICAL OPERATING CHARACTERISTICS

(over recommended operating conditions unless specified otherwise) $V_{IN} = 3.6\text{ V}$, $EN = \text{High}$, $T_{AMB} = 25^\circ\text{C}$

Symbol	Name	Conditions	Min	Typ	Max	Units
I_Q	Quiescent Current	1x mode, excluding load 1.33x mode, excluding load 1.5x mode, excluding load 2x mode, excluding load		1.0 1.7 2.2 2.4		mA
I_{QSHDN}	Shutdown Current	$V_{EN} = 0\text{ V}$			1	μA
$I_{LED-ACC}$	LED Current Setting	RSET = 3.74 k Ω		20		mA
		RSET = 7.50 k Ω		10		
$I_{LED-ACC}$	LED Current Accuracy	$(I_{LEDAVG} - I_{NOMINAL}) / I_{NOMINAL}$ RSET = 4.99 k Ω		± 2		%
$I_{LED-DEV}$	LED Channel Matching	$(I_{LED} - I_{LEDAVG}) / I_{LEDAVG}$		± 1.5		%
V_{RSET}	RSET Regulated Voltage		0.58	0.6	0.62	V
R_{OUT}	Output Resistance (open loop)	1x mode 1.33x mode, $V_{IN} = 3\text{ V}$ 1.5x mode, $V_{IN} = 2.7\text{ V}$ 2x mode, $V_{IN} = 2.4\text{ V}$		0.8 5 5 10		Ω
F_{OSC}	Charge Pump Frequency	1.33x and 2x mode 1.5x mode	0.8 1	1 1.3	1.3 1.6	MHz
I_{SC_MAX}	Output short circuit Current Limit	$V_{OUT} < 0.5\text{ V}$		50		mA
I_{IN_MAX}	Input Current Limit	$V_{OUT} > 1\text{ V}$, 1x mode		250		mA
LED_{TH}	1x to 1.33x or 1.33x to 1.5x or 1.5x to 2x Transition Thresholds at any LED pin			130		mV
V_{HYS}	1x Mode Transition Hysteresis			400		mV
T_{DF}	Mode Transition Filter Delay			120		μs
$R_{EN/DIM}$ V_{HI} V_{LO}	EN/DIM Pin – Internal Pull-down Resistor – Logic High Level – Logic Low Level		1.3	100	0.4	k Ω V V
T_{SD}	Thermal Shutdown			150		$^\circ\text{C}$
T_{HYS}	Thermal Hysteresis			20		$^\circ\text{C}$
V_{UVLO}	Undervoltage lockout (UVLO) threshold		1.6	1.8	2.0	V

Table 4. RECOMMENDED EN/DIM TIMING

(For $2.4\text{ V} \leq V_{IN} \leq 5.5\text{ V}$, over full ambient temperature range -40°C to $+85^{\circ}\text{C}$.)

Symbol	Name	Conditions	Min	Typ	Max	Units
T_{LO}	EN/DIM program low time		0.2		100	μs
T_{HI}	EN/DIM program high time		0.2			μs
T_{PWRDWN}	EN/DIM low time to shutdown		1.5			ms
T_{LED}	LED current settling time			40		μs

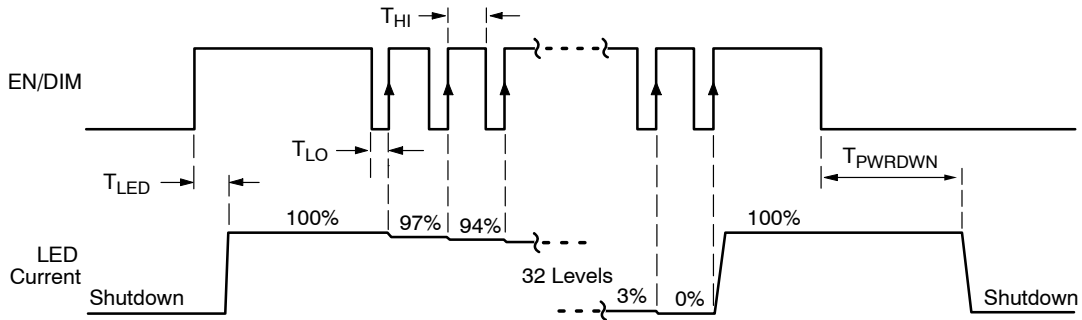

Figure 2. EN/DIM Digital Dimming Timing Diagram

LED Current Setting

The full scale LED current is set by the external resistor connected between the RSET pin and ground. Table 5 lists standard resistor values for several LED current settings.

Table 5. RESISTOR RSET AND LED CURRENT

Full Scale LED Current [mA]	RSET [k Ω]
2	37.4
5	14.7
10	7.50
15	4.99
20	3.74
25	3.00
30	2.49

TYPICAL PERFORMANCE CHARACTERISTICS

($V_{IN} = 3.6\text{ V}$, $I_{OUT} = 80\text{ mA}$ (4 LEDs at 20 mA), $C_{IN} = C_{OUT} = C_1 = C_2 = 1\ \mu\text{F}$, $T_{AMB} = 25^\circ\text{C}$ unless otherwise specified.)

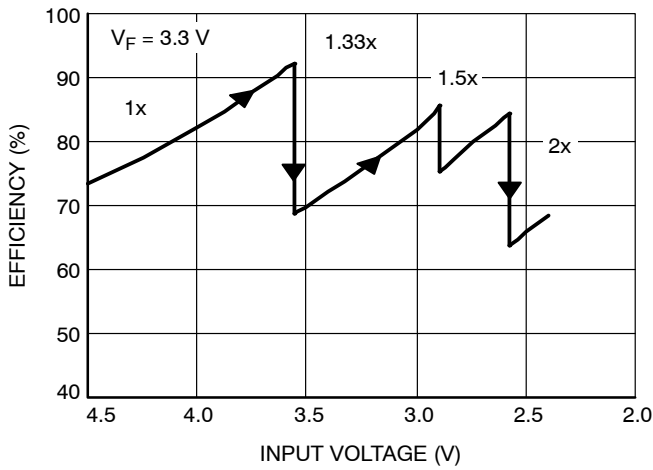

Figure 3. Efficiency vs. Input Voltage

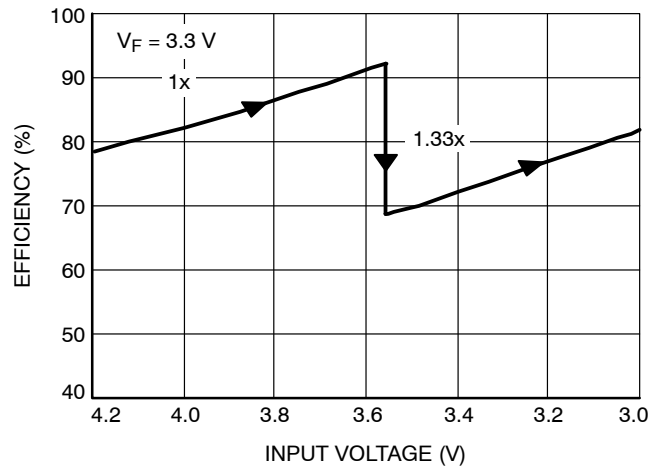

Figure 4. Efficiency vs. Li-Ion Voltage

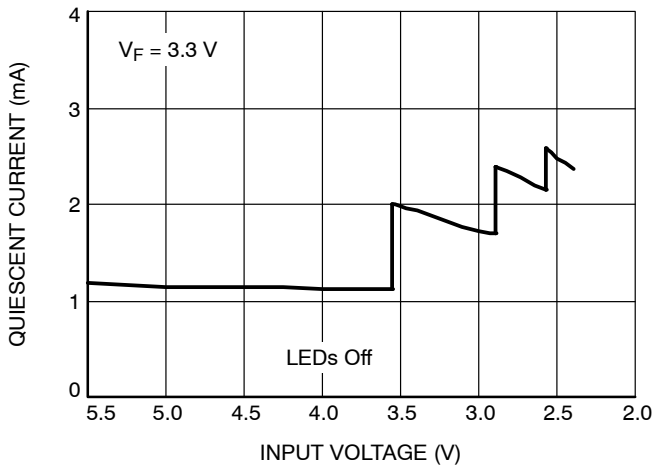

Figure 5. Quiescent Current vs. Input Voltage

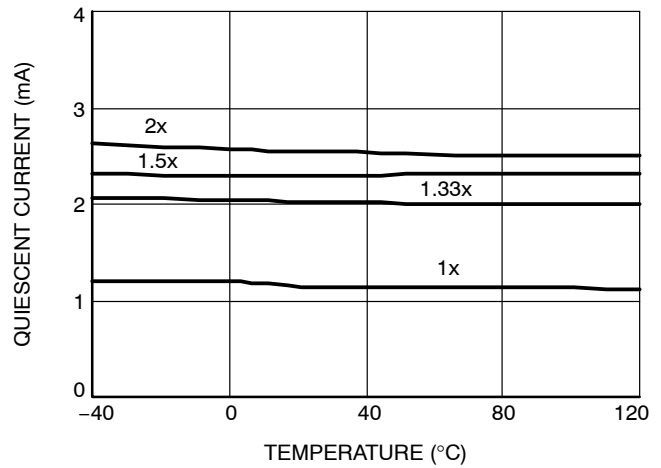

Figure 6. Quiescent Current vs. Temperature

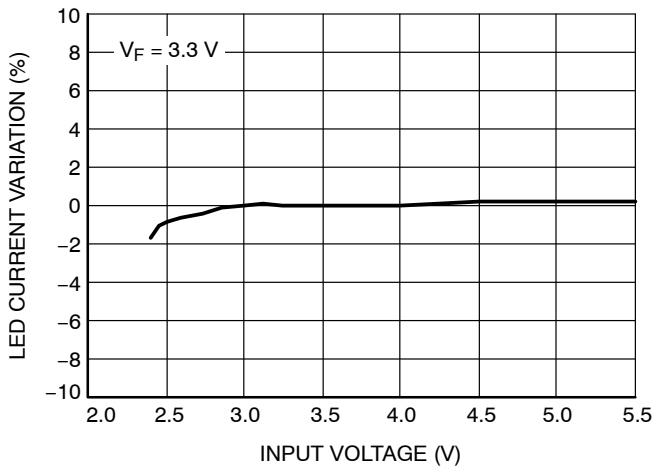

Figure 7. LED Current Change vs. Input Voltage

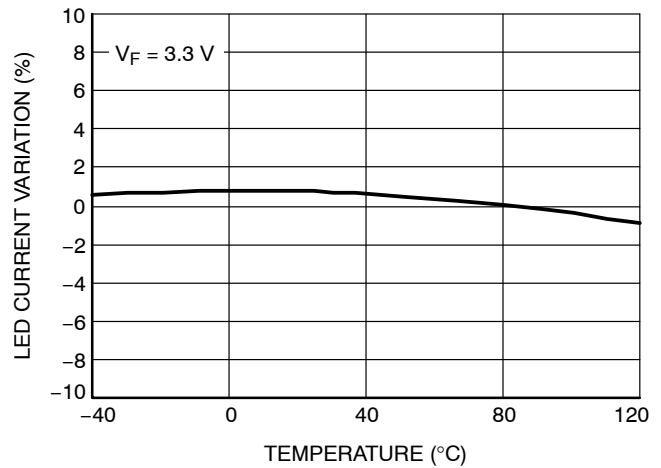

Figure 8. LED Current Change vs. Temperature

TYPICAL PERFORMANCE CHARACTERISTICS

($V_{IN} = 3.6\text{ V}$, $I_{OUT} = 80\text{ mA}$ (4 LEDs at 20 mA), $C_{IN} = C_{OUT} = C_1 = C_2 = 1\ \mu\text{F}$, $T_{AMB} = 25^\circ\text{C}$ unless otherwise specified.)

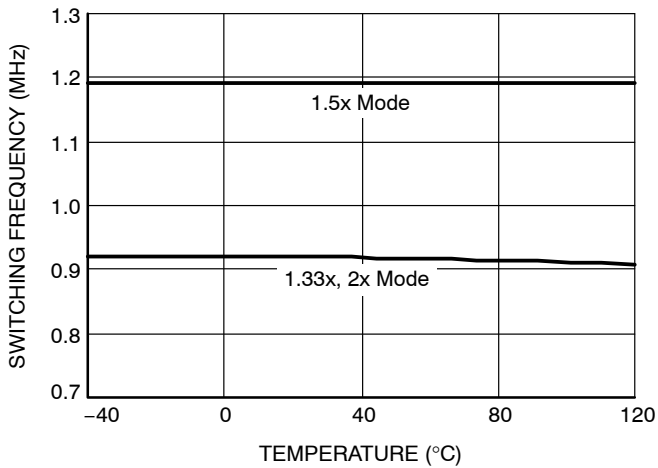

Figure 9. Switching Frequency vs. Temperature

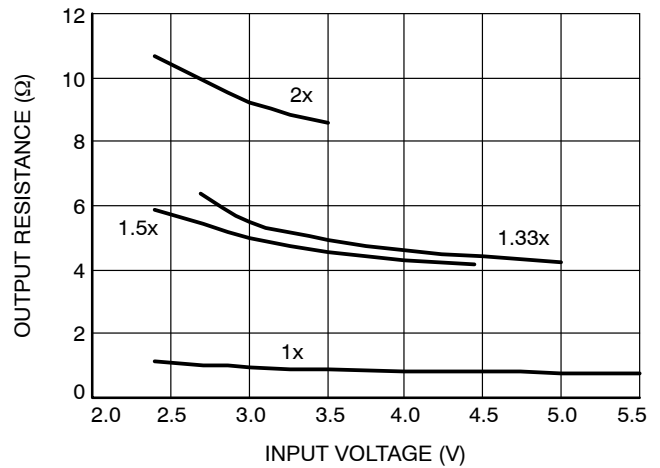

Figure 10. Output Resistance vs. Input Voltage

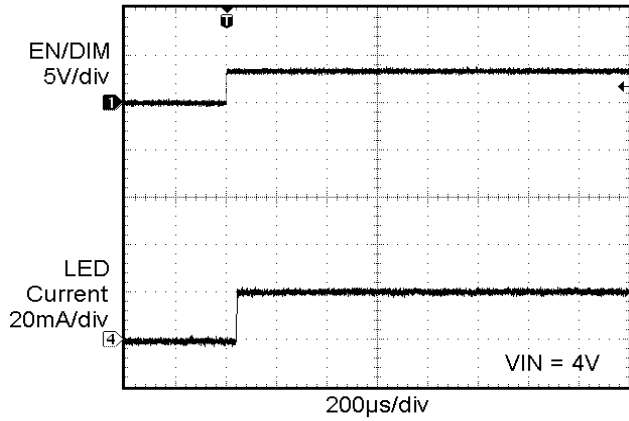

Figure 11. Power Up in 1x Mode

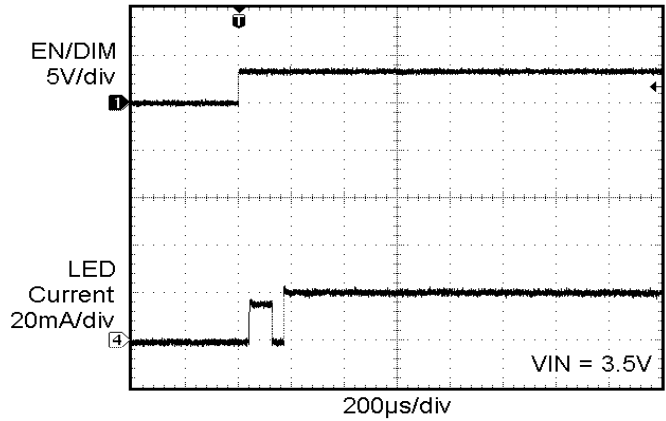

Figure 12. Power Up in 1.33x Mode

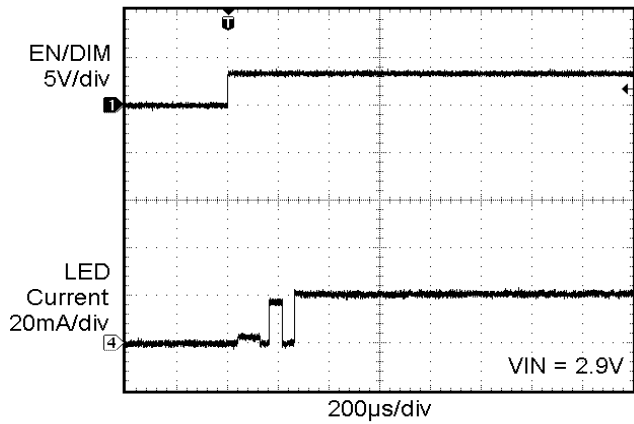

Figure 13. Power Up in 1.5x Mode

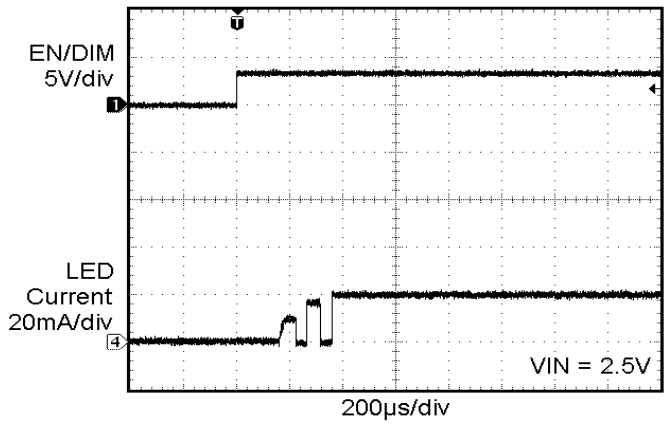

Figure 14. Power Up in 2x Mode

TYPICAL PERFORMANCE CHARACTERISTICS

($V_{IN} = 3.6\text{ V}$, $I_{OUT} = 80\text{ mA}$ (4 LEDs at 20 mA), $C_{IN} = C_{OUT} = C_1 = C_2 = 1\ \mu\text{F}$, $T_{AMB} = 25^\circ\text{C}$ unless otherwise specified.)

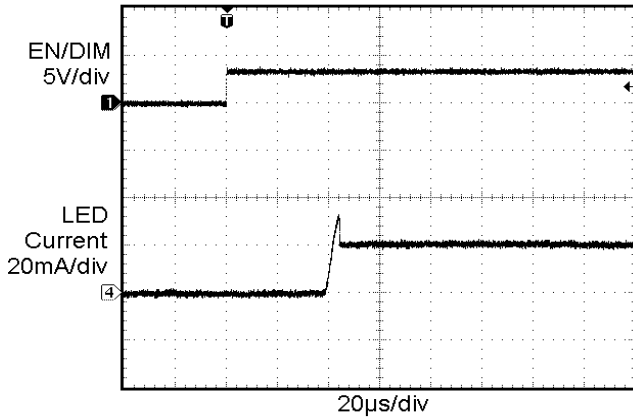

Figure 15. Power Up Delay (1x Mode)

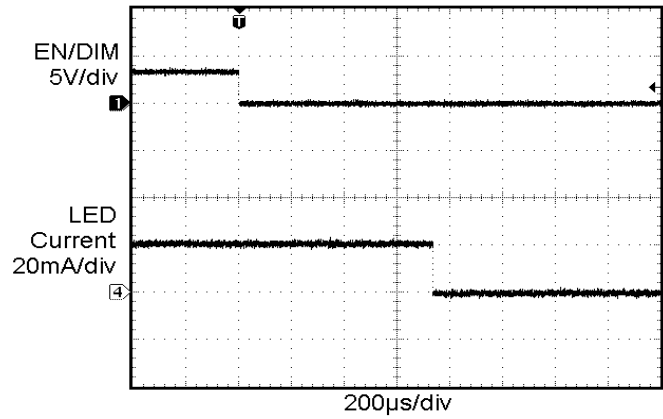

Figure 16. Power Down Delay (1x Mode)

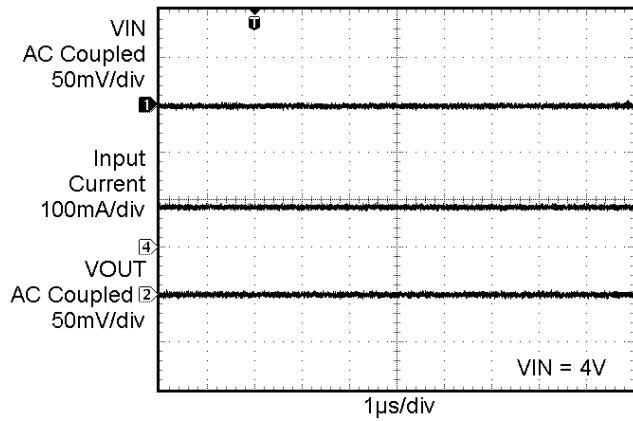

Figure 17. Operating Waveforms in 1x Mode

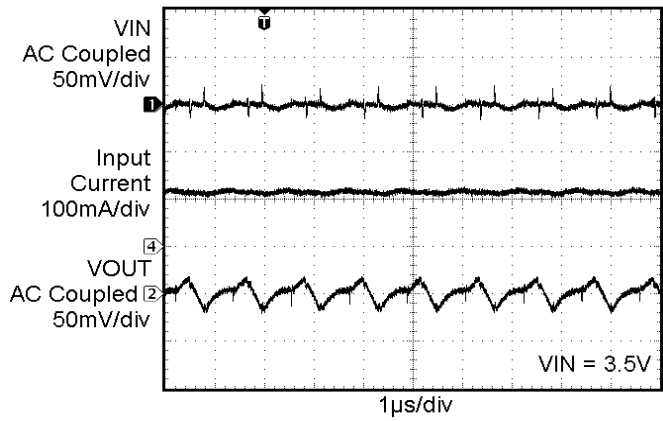

Figure 18. Switching Waveforms in 1.33x Mode

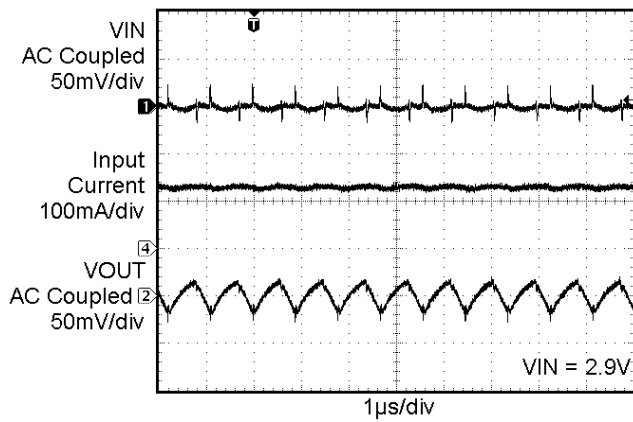

Figure 19. Switching Waveforms in 1.5x Mode

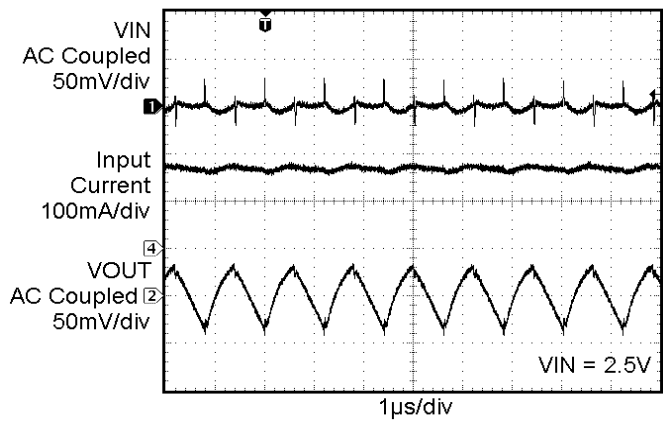

Figure 20. Switching Waveforms in 2x Mode

CAT3648

TYPICAL PERFORMANCE CHARACTERISTICS

($V_{IN} = 3.6\text{ V}$, $I_{OUT} = 80\text{ mA}$ (4 LEDs at 20 mA), $C_{IN} = C_{OUT} = C_1 = C_2 = 1\ \mu\text{F}$, $T_{AMB} = 25^\circ\text{C}$ unless otherwise specified.)

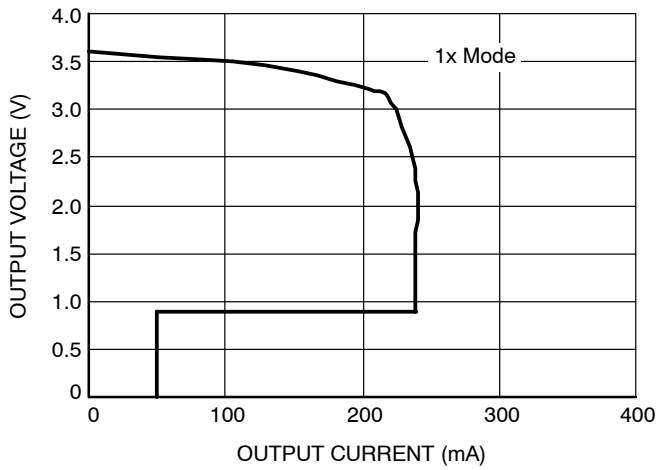

Figure 21. Foldback Current Limit

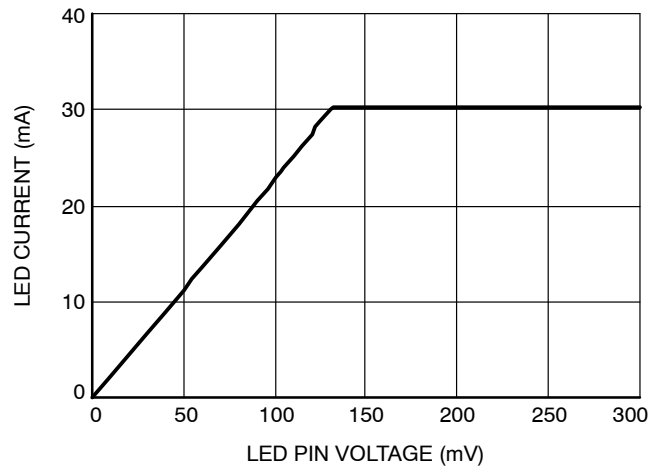

Figure 22. LED Current vs. LED Pin Voltage

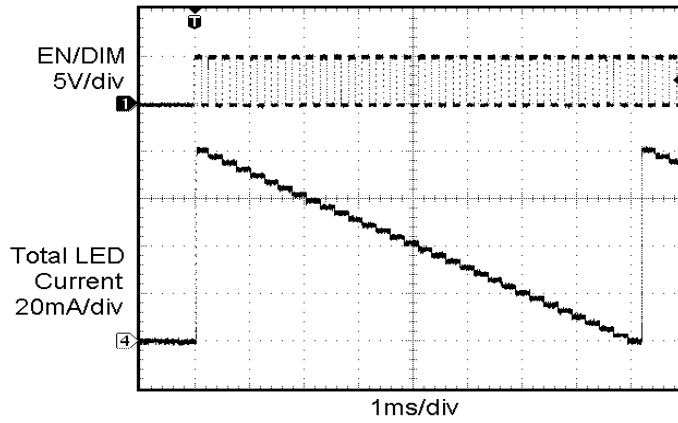

Figure 23. Dimming Waveform

Table 6. PIN DESCRIPTION

Pin #	Name	Function
1	LED2	LED2 cathode terminal.
2	LED3	LED3 cathode terminal.
3	LED4	LED4 cathode terminal.
4	RSET	Connect resistor RSET to set the LED current.
5	EN/DIM	Device enable (active high) and Dimming Control.
6	VOUT	Charge pump output connected to the LED anodes.
7	NC	Not connected inside the package.
8	VIN	Charge pump input, connect to battery or supply.
9	C1+	Bucket capacitor 1 Positive terminal
10	C1-	Bucket capacitor 1 Negative terminal
11	C2+	Bucket capacitor 2 Positive terminal
12	C2-	Bucket capacitor 2 Negative terminal
13	NC	Not connected inside the package.
14	NC	Not connected inside the package.
15	GND	Ground Reference
16	LED1	LED1 cathode terminal.
TAB	GND	Connect to GND on the PCB.

Pin Function

VIN is the supply pin for the charge pump. A small 1 μ F ceramic bypass capacitor is required between the VIN pin and ground near the device. The operating input voltage range is from 2.5 V to 5.5 V. Whenever the input supply falls below the under-voltage threshold (1.8 V), all the LED channels are disabled and the device enters shutdown mode.

EN/DIM is the enable and one wire dimming input for all LED channels. Levels of logic high and logic low are set at 1.3 V and 0.4 V respectively. When EN/DIM is initially taken high, the device becomes enabled and all LED currents are set to the full scale according to the resistor R_{SET}. To place the device into “zero current” shutdown mode, the EN/DIM pin must be held low for at least 1.5 ms.

VOUT is the charge pump output that is connected to the LED anodes. A small 1 μ F ceramic bypass capacitor is required between the V_{OUT} pin and ground near the device.

GND is the ground reference for the charge pump. The pin must be connected to the ground plane on the PCB.

C1+, C1- are connected to each side of the ceramic bucket capacitor C₁.

C2+, C2- are connected to each side of the ceramic bucket capacitor C₂.

LED1 to LED4 provide the internal regulated current source for each of the LED cathodes. These pins enter high-impedance zero current state whenever the device is placed in shutdown mode.

TAB is the exposed pad underneath the package. For best thermal performance, the tab should be soldered to the PCB and connected to the ground plane.

RSET is connected to the resistor (R_{SET}) to set the full scale current for the LEDs. The voltage at this pin regulated to 0.6 V. The ground side of the external resistor should be star connected back to the GND of the PCB. In shutdown mode, RSET becomes high impedance.

Block Diagram

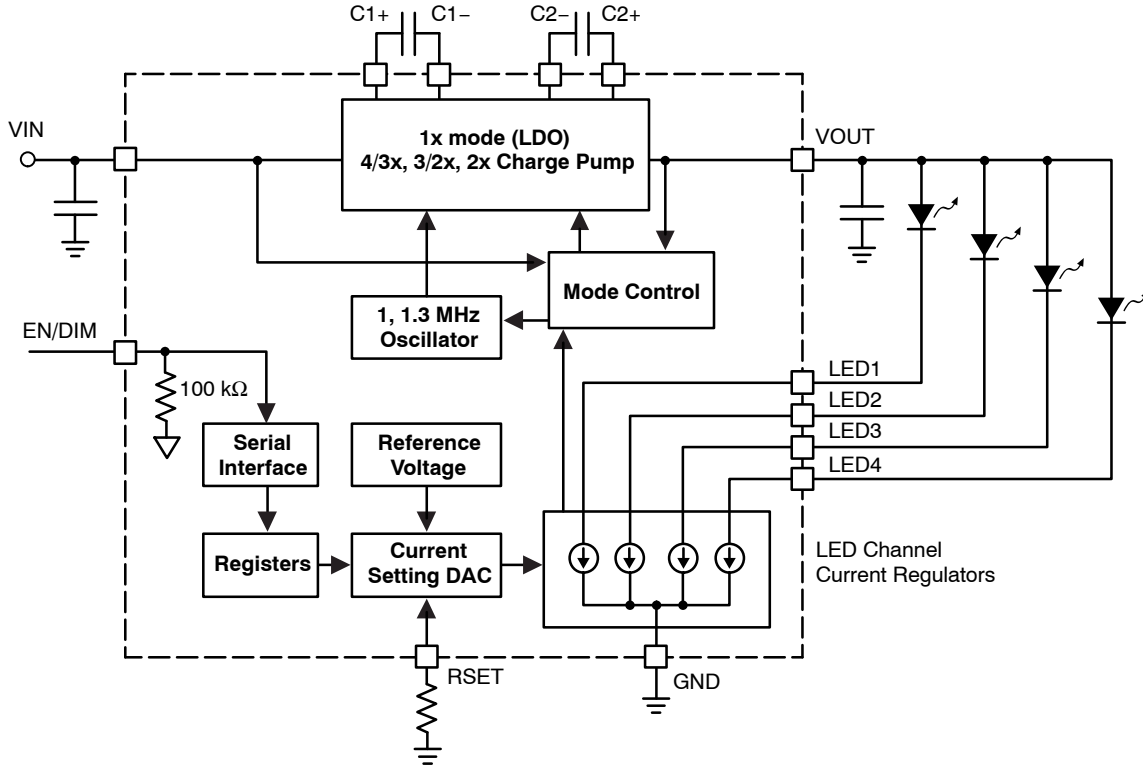

Figure 24. CAT3648 Functional Block Diagram

Basic Operation

At power-up, the CAT3648 starts operating in 1x mode where the output will be approximately equal to the input supply voltage (less any internal voltage losses). If the output voltage is sufficient to regulate all LED currents, the device remains in 1x operating mode.

If the input voltage is insufficient or falls to a level where the regulated currents cannot be maintained, the device automatically switches into 1.33x mode (after a fixed delay time of about 120 μ s). In 1.33x mode, the output voltage is approximately equal to 1.33 times the input supply voltage (less any internal voltage losses).

This sequence repeats in the 1.33x and 1.5x mode until the driver enters the 2x mode. In 1.5x mode, the output voltage is approximately equal to 1.5 times the input supply voltage. While in 2x mode, the output is approximately equal to 2 times the input supply voltage.

If the device detects a sufficient input voltage is present to drive all LED currents in 1x mode, it will change automatically back to 1x mode. This only applies for changing back to the 1x mode. The difference between the input voltage when exiting 1x mode and returning to 1x mode is called the 1x mode transition hysteresis (V_{HYS}) and is about 400 mV.

LED Current Selection

After power-up, the LED current is set by the external resistor (R_{SET}) value and the number of pulses (n) on the EN/DIM input as follows:

$$\text{LED current} = 125 \times \frac{0.6 \text{ V}}{R_{\text{SET}}} \times \left(\frac{31 - n}{31} \right)$$

The full scale current is calculated from the above formula with n equal to zero.

The EN/DIM pin has two primary functions. One function enables and disables the device. The other function is LED current dimming with 32 different levels by pulsing the input signal, as shown on Figure 25. On each consecutive pulse rising edge, the LED current is decreased by about 3.2% (1/31th of the full scale value). After 30 pulses, the LED current is 3.2% of the full scale current. On the 31st pulse, the current drops to zero, and then goes back to full scale on the following pulse.

Each pulse width should be between 200 ns and 100 μs. Pulses faster than the minimum T_{LO} may be ignored and filtered by the device. Pulses longer than the maximum T_{LO} may shutdown the device. By pulsing the EN/DIM signal at high frequency, the LED current can quickly be set to zero.

The LED driver enters a “zero current” shutdown mode if EN/DIM is held low for 1.5 ms or more.

The dimming level is set by the number of pulses on the EN/DIM after the power-up, as shown in Table 7.

Table 7. DIMMING LEVELS

Full Scale Current in %	Dimming Pulses [n]
100	0
97	1
94	2
90	3
87	4
84	5
81	6
77	7
74	8
71	9
68	10
65	11
61	12
58	13
55	14
52	15
48	16
45	17
42	18
39	19
35	20
32	21
29	22
26	23
23	24
19	25
16	26
13	27
10	28
6	29
3	30
0	31
100	32

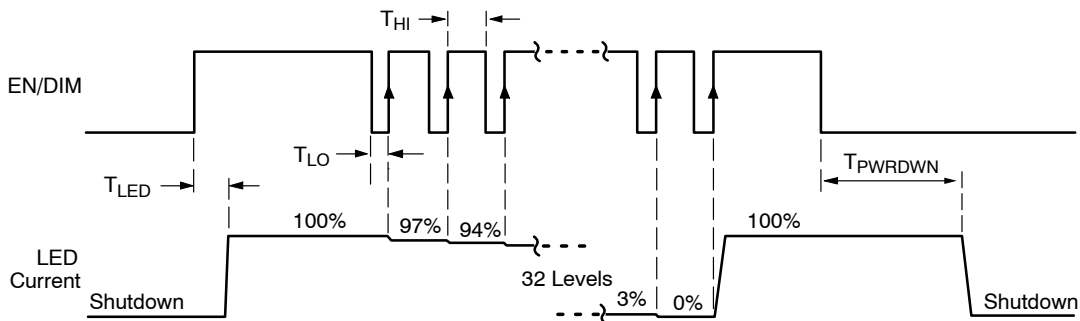

Figure 25. EN/DIM Digital Dimming Timing Diagram

CAT3648

Unused LED Channels

For applications not requiring all the channels, it is recommended the unused LED pins be tied directly to VOUT (see Figure 26).

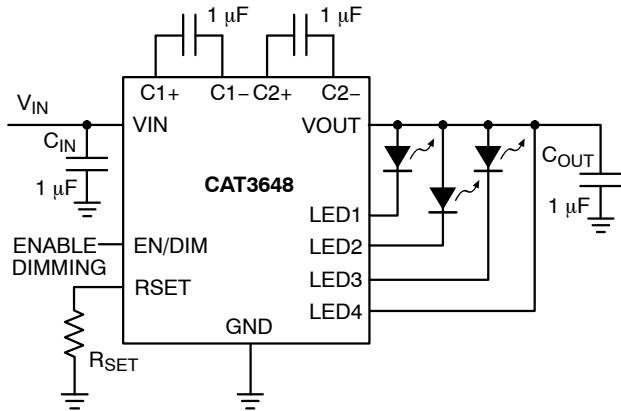

Figure 26. Application with 3 LEDs

Protection Mode

If an LED is disconnected, the driver senses that and automatically ignores that channel. When all LEDs are disconnected, the driver goes to 1x mode where the output is equal to the input voltage.

As soon as the output exceeds about 6 V, the driver resets itself and re-evaluates the mode.

If the die temperature exceeds +150°C, the driver will enter a thermal protection shutdown mode. When the device temperature drops by about 20°C, the device will resume normal operation.

LED Selection

LEDs with forward voltages (V_F) ranging from 1.3 V to 4.3 V may be used. Selecting LEDs with lower V_F is recommended in order to improve the efficiency by keeping the driver in 1x mode longer as the battery voltage decreases.

For example, if a white LED with a V_F of 3.3 V is selected over one with V_F of 3.5 V, the driver will stay in 1x mode for lower supply voltage of 0.2 V. This helps improve the efficiency and extends battery life.

External Components

The driver requires four external 1 μ F ceramic capacitors for decoupling input, output, and for the charge pump. Both capacitors type X5R and X7R are recommended for the LED driver application. In all charge pump modes, the input current ripple is kept very low by design and an input bypass capacitor of 1 μ F is sufficient.

In 1x mode, the device operates in linear mode and does not introduce switching noise back onto the supply.

Recommended Layout

In charge pump mode, the driver switches internally at a high frequency. It is recommended to minimize trace length to all four capacitors. A ground plane should cover the area under the driver IC as well as the bypass capacitors. Short connection to ground on capacitors C_{IN} and C_{OUT} can be implemented with the use of multiple via. A copper area matching the TQFN exposed pad (TAB) must be connected to the ground plane underneath. The use of multiple via improves the package heat dissipation.

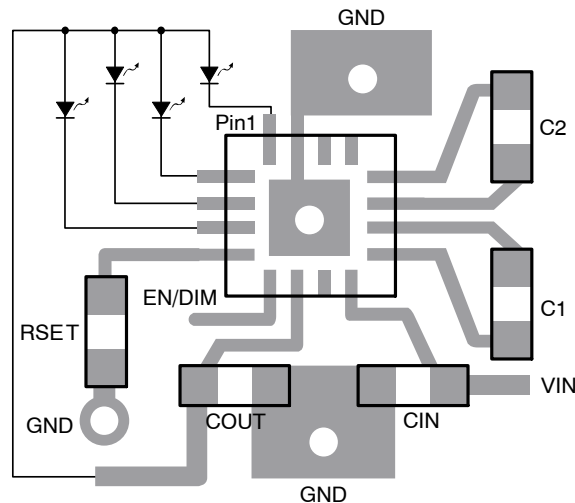
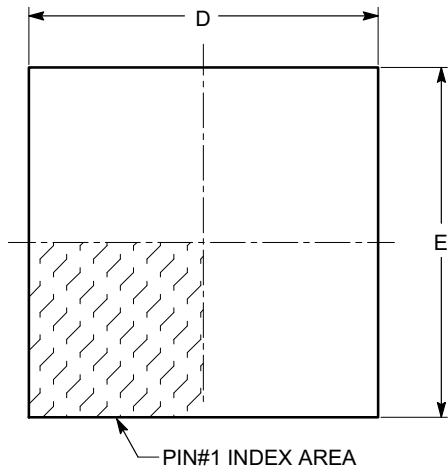

Figure 27. Recommended Layout

CAT3648

PACKAGE DIMENSIONS

TQFN16, 3x3
CASE 510AD-01
ISSUE A



TOP VIEW

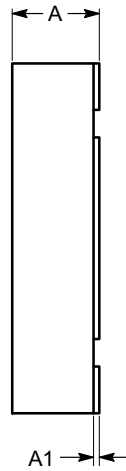

SIDE VIEW

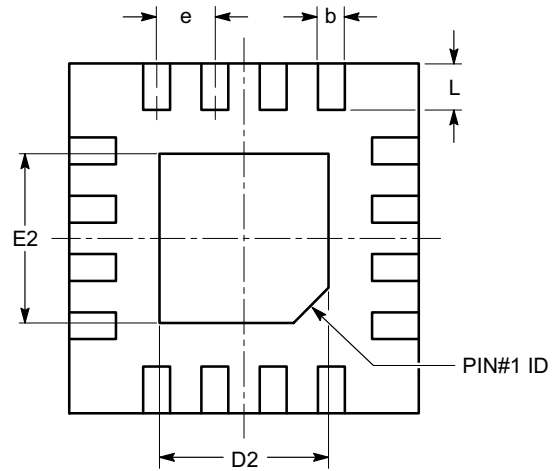

BOTTOM VIEW

SYMBOL	MIN	NOM	MAX
A	0.70	0.75	0.80
A1	0.00	0.02	0.05
A3	0.20 REF		
b	0.18	0.25	0.30
D	2.90	3.00	3.10
D2	1.40	---	1.80
E	2.90	3.00	3.10
E2	1.40	---	1.80
e	0.50 BSC		
L	0.30	0.40	0.50

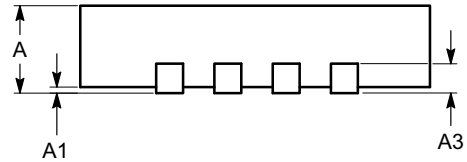

FRONT VIEW

Notes:

- (1) All dimensions are in millimeters.
- (2) Complies with JEDEC MO-220.

CAT3648

Example of Ordering Information (Note 4)

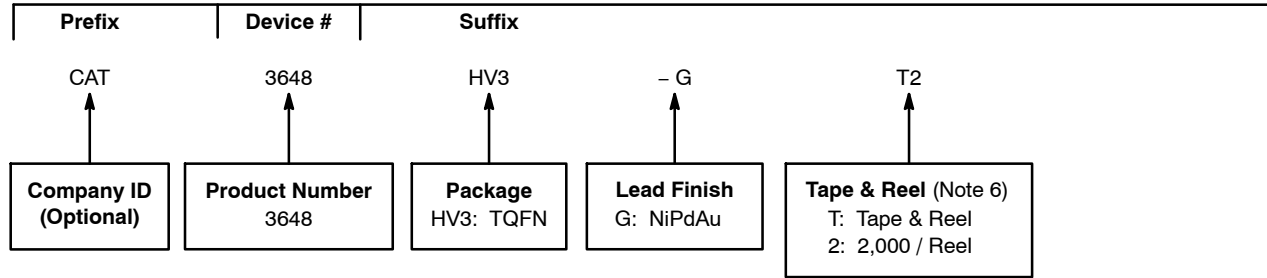

2. All packages are RoHS-compliant (Lead-free, Halogen-free).
3. The standard lead finish is NiPdAu.
4. The device used in the above example is a CAT3648HV3-GT2 (TQFN, NiPdAu, Tape & Reel, 2,000/Reel).
5. For additional package and temperature options, please contact your nearest ON Semiconductor Sales office.
6. For information on tape and reel specifications, including part orientation and tape sizes, please refer to our Tape and Reel Packaging Specifications Brochure, BRD8011/D.

EZDim is a trademark of Semiconductor Components Industries, LLC.

Quad-Mode is a registered trademark of Semiconductor Components Industries, LLC.

ON Semiconductor and  are registered trademarks of Semiconductor Components Industries, LLC (SCILLC). SCILLC reserves the right to make changes without further notice to any products herein. SCILLC makes no warranty, representation or guarantee regarding the suitability of its products for any particular purpose, nor does SCILLC assume any liability arising out of the application or use of any product or circuit, and specifically disclaims any and all liability, including without limitation special, consequential or incidental damages. "Typical" parameters which may be provided in SCILLC data sheets and/or specifications can and do vary in different applications and actual performance may vary over time. All operating parameters, including "Typicals" must be validated for each customer application by customer's technical experts. SCILLC does not convey any license under its patent rights nor the rights of others. SCILLC products are not designed, intended, or authorized for use as components in systems intended for surgical implant into the body, or other applications intended to support or sustain life, or for any other application in which the failure of the SCILLC product could create a situation where personal injury or death may occur. Should Buyer purchase or use SCILLC products for any such unintended or unauthorized application, Buyer shall indemnify and hold SCILLC and its officers, employees, subsidiaries, affiliates, and distributors harmless against all claims, costs, damages, and expenses, and reasonable attorney fees arising out of, directly or indirectly, any claim of personal injury or death associated with such unintended or unauthorized use, even if such claim alleges that SCILLC was negligent regarding the design or manufacture of the part. SCILLC is an Equal Opportunity/Affirmative Action Employer. This literature is subject to all applicable copyright laws and is not for resale in any manner.

PUBLICATION ORDERING INFORMATION

LITERATURE FULFILLMENT:

Literature Distribution Center for ON Semiconductor
P.O. Box 5163, Denver, Colorado 80217 USA
Phone: 303-675-2175 or 800-344-3860 Toll Free USA/Canada
Fax: 303-675-2176 or 800-344-3867 Toll Free USA/Canada
Email: orderlit@onsemi.com

N. American Technical Support: 800-282-9855 Toll Free
USA/Canada
Europe, Middle East and Africa Technical Support:
Phone: 421 33 790 2910
Japan Customer Focus Center
Phone: 81-3-5773-3850

ON Semiconductor Website: www.onsemi.com

Order Literature: <http://www.onsemi.com/orderlit>

For additional information, please contact your local Sales Representative

Компания «Океан Электроники» предлагает заключение долгосрочных отношений при поставках импортных электронных компонентов на взаимовыгодных условиях!

Наши преимущества:

- Поставка оригинальных импортных электронных компонентов напрямую с производств Америки, Европы и Азии, а так же с крупнейших складов мира;
- Широкая линейка поставок активных и пассивных импортных электронных компонентов (более 30 млн. наименований);
- Поставка сложных, дефицитных, либо снятых с производства позиций;
- Оперативные сроки поставки под заказ (от 5 рабочих дней);
- Экспресс доставка в любую точку России;
- Помощь Конструкторского Отдела и консультации квалифицированных инженеров;
- Техническая поддержка проекта, помощь в подборе аналогов, поставка прототипов;
- Поставка электронных компонентов под контролем ВП;
- Система менеджмента качества сертифицирована по Международному стандарту ISO 9001;
- При необходимости вся продукция военного и аэрокосмического назначения проходит испытания и сертификацию в лаборатории (по согласованию с заказчиком);
- Поставка специализированных компонентов военного и аэрокосмического уровня качества (Xilinx, Altera, Analog Devices, Intersil, Interpoint, Microsemi, Actel, Aeroflex, Peregrine, VPT, Syfer, Eurofarad, Texas Instruments, MS Kennedy, Miteq, Cobham, E2V, MA-COM, Hittite, Mini-Circuits, General Dynamics и др.);

Компания «Океан Электроники» является официальным дистрибьютором и эксклюзивным представителем в России одного из крупнейших производителей разъемов военного и аэрокосмического назначения «JONHON», а так же официальным дистрибьютором и эксклюзивным представителем в России производителя высокотехнологичных и надежных решений для передачи СВЧ сигналов «FORSTAR».



JONHON

«JONHON» (основан в 1970 г.)

Разъемы специального, военного и аэрокосмического назначения:

(Применяются в военной, авиационной, аэрокосмической, морской, железнодорожной, горно- и нефтедобывающей отраслях промышленности)

«FORSTAR» (основан в 1998 г.)

ВЧ соединители, коаксиальные кабели,
кабельные сборки и микроволновые компоненты:

(Применяются в телекоммуникациях гражданского и специального назначения, в средствах связи, РЛС, а так же военной, авиационной и аэрокосмической отраслях промышленности).



Телефон: 8 (812) 309-75-97 (многоканальный)

Факс: 8 (812) 320-03-32

Электронная почта: ocean@oceanchips.ru

Web: <http://oceanchips.ru/>

Адрес: 198099, г. Санкт-Петербург, ул. Калинина, д. 2, корп. 4, лит. А