

Dual 1 Form A Solid-State Relay

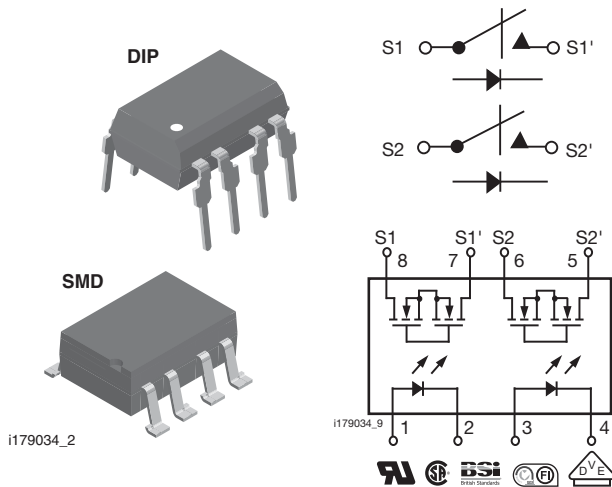

DESCRIPTION

The LH1520 dual 1 form A relays are SPST normally open switches that can replace electromechanical relays in many applications. They are constructed using a GaAlAs LED for actuation control and an integrated monolithic die for the switch output. The die, fabricated in a high-voltage dielectrically isolated technology is comprised of a photodiode array, switch control circuitry, and MOSFET switches. In addition, the LH1520 SSRs employ current limiting circuitry, enabling them to pass lightning surge testing as per ANSI/TIA-968-B and other regulatory surge requirements when overvoltage protection is provided.

FEATURES

- Dual channel (LH1500)
- Current limit protection
- Isolation test voltage 5300 V_{RMS}
- Typical R_{ON} 20 Ω
- Load voltage 350 V
- Load current 150 mA
- High surge capability
- Clean bounce free switching
- Low power consumption
- Compliant to RoHS Directive 2002/95/EC and in accordance to WEEE 2002/96/EC



RoHS
COMPLIANT

APPLICATIONS

- General telecom switching
 - On/off hook control
 - Ring delay
 - Dial pulse
 - Ground start
 - Ground fault protection
- Instrumentation
- Industrial controls

AGENCY APPROVALS

- UL1577: file no. E52744 system code H, double protection
- CSA: certification no. 093751
- BSI/BABT: certification no. 7980
- DIN EN: 60747-5-2 (VDE 0884)/60747-5-5 (pending), available with option 1
- FIMKO: approval

ORDERING INFORMATION												
L	H	1	5	2	0	A	#	#	T	R		
PART NUMBER						ELECTR. VARIATION	PACKAGE CONFIG.		TAPE AND REEL			
PACKAGE						UL, CSA, BSI, FIMKO						
SMD-8, tubes						LH1520AAC						
SMD-8, tape and reel						LH1520AACTR						
DIP-8, tubes						LH1520AB						



ABSOLUTE MAXIMUM RATINGS ($T_{amb} = 25\text{ }^{\circ}\text{C}$, unless otherwise specified)				
PARAMETER	TEST CONDITION	SYMBOL	VALUE	UNIT
INPUT				
LED continuous forward current		I_F	50	mA
LED reverse voltage	$I_R \leq 10\text{ }\mu\text{A}$	V_R	8	V
OUTPUT				
DC or peak AC load voltage	$I_L \leq 50\text{ }\mu\text{A}$	V_L	350	V
Continuous DC load current, one pole operating		I_L	150	mA
Continuous DC load current, two poles operating		I_L	110	mA
Peak load current (single shot), form B	$t = 100\text{ ms}$	I_P	(2)	
SSR				
Ambient temperature range		T_{amb}	- 40 to + 85	$^{\circ}\text{C}$
Storage temperature range		T_{stg}	- 40 to + 150	$^{\circ}\text{C}$
Pin soldering temperature (3)	$t = 10\text{ s max.}$	T_{sld}	260	$^{\circ}\text{C}$
Input to output isolation test voltage	$t = 1\text{ s, } I_{ISO} = 10\text{ }\mu\text{A max.}$	V_{ISO}	5300	V_{RMS}
Pole-to-pole isolation voltage (S1 to S2) (1) (dry air, dust free, at sea level)			1600	V
Output power dissipation (continuous)		P_{diss}	600	mW

Notes

- Stresses in excess of the absolute maximum ratings can cause permanent damage to the device. Functional operation of the device is not implied at these or any other conditions in excess of those given in the operational sections of this document. Exposure to absolute maximum ratings for extended periods of the time can adversely affect reliability.
- Breakdown occurs between the output pins external to the package.
- Refer to current limit performance application note for a discussion on relay operation during transient currents.
- Refer to reflow profile for soldering conditions for surface mounted devices (SMD). Refer to wave profile for soldering conditions for through hole devices (DIP).

ELECTRICAL CHARACTERISTICS ($T_{amb} = 25\text{ }^{\circ}\text{C}$, unless otherwise specified)						
PARAMETER	TEST CONDITION	SYMBOL	MIN.	TYP.	MAX.	UNIT
INPUT						
LED forward current, switch turn-on	$I_L = 100\text{ mA, } t = 10\text{ ms}$	I_{Fon}		1	2	mA
LED forward current, switch turn-off	$V_L = \pm 300\text{ V}$	I_{Foff}	0.2	1.1		mA
LED forward voltage	$I_F = 10\text{ mA}$	V_F	1.15	1.26	1.45	V
OUTPUT						
On-resistance	$I_F = 5\text{ mA, } I_L = 50\text{ mA}$	R_{ON}	12	20	25	Ω
Off-resistance	$I_F = 0\text{ mA, } V_L = \pm 100\text{ V}$	R_{OFF}	0.5	300		$G\Omega$
Current limit	$I_F = 5\text{ mA, } t = 5\text{ ms, } V_L = \pm 6\text{ V}$	I_{LMT}	230	270	370	mA
Off-state leakage current	$I_F = 0\text{ mA, } V_L = \pm 100\text{ V}$	I_O		0.32	200	nA
	$I_F = 0\text{ mA, } V_L = \pm 350\text{ V}$	I_O			1	μA
Output capacitance	$I_F = 0\text{ mA, } V_L = 1\text{ V}$	C_O		55		pF
	$I_F = 0\text{ mA, } V_L = 50\text{ V}$	C_O		10		pF
Pole-to-pole capacitance (S1 to S2)	$I_F = 5\text{ mA}$			0.5		pF
Switch offset	$I_F = 5\text{ mA}$	V_{OS}		0.15		μV
TRANSFER						
Capacitance (input to output)	$V_{ISO} = 1\text{ V}$	C_{IO}		1.1		pF

Note

- Minimum and maximum values are testing requirements. Typical values are characteristics of the device and are the result of engineering evaluations. Typical values are for information only and are not part of the testing requirements.

SWITCHING CHARACTERISTICS ($T_{amb} = 25\text{ }^{\circ}\text{C}$, unless otherwise specified)						
PARAMETER	TEST CONDITION	SYMBOL	MIN.	TYP.	MAX.	UNIT
Turn-on time	$I_F = 5\text{ mA, } I_L = 50\text{ mA}$	t_{on}		1.4	2	ms
Turn-off time	$I_F = 5\text{ mA, } I_L = 50\text{ mA}$	t_{off}		0.7	2	ms

TYPICAL CHARACTERISTICS ($T_{amb} = 25\text{ }^{\circ}\text{C}$, unless otherwise specified)

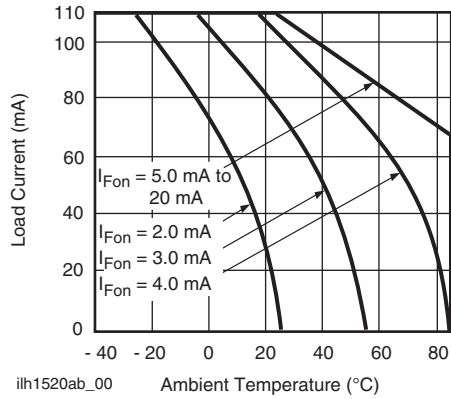

Fig. 1 - Recommended Operating Conditions

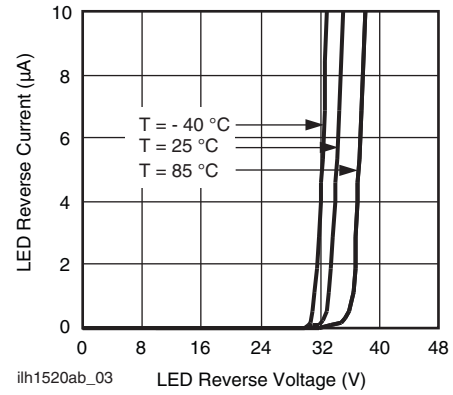

Fig. 4 - LED Reverse Current vs. LED Reverse Voltage

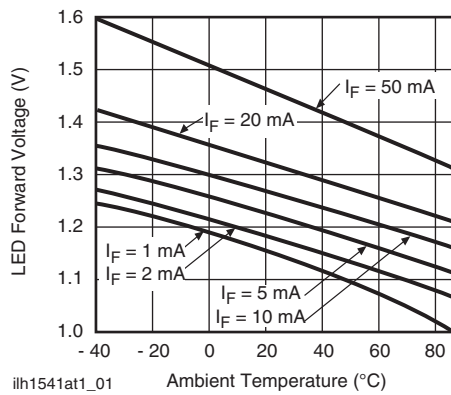

Fig. 2 - LED Voltage vs. Temperature

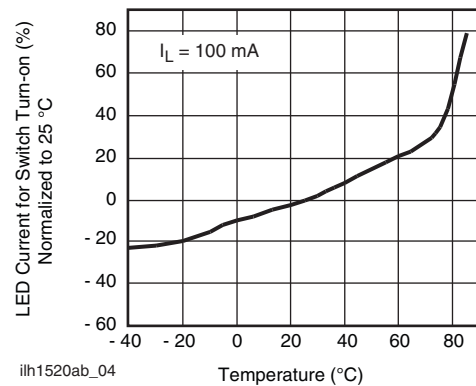

Fig. 5 - LED Current for Switch Turn-on vs. Temperature

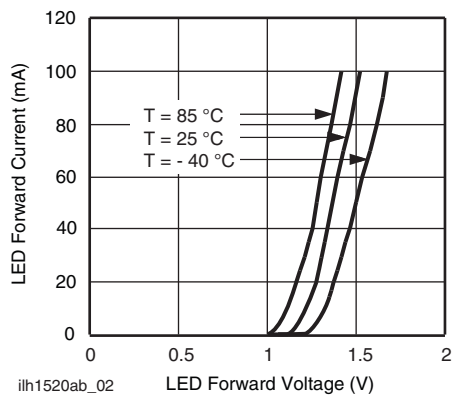

Fig. 3 - LED Forward Current vs. LED Forward Voltage

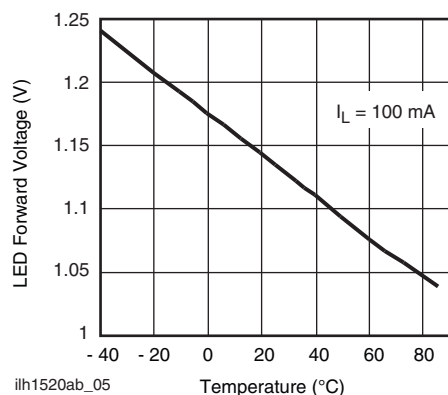

Fig. 6 - LED Dropout Voltage vs. Temperature

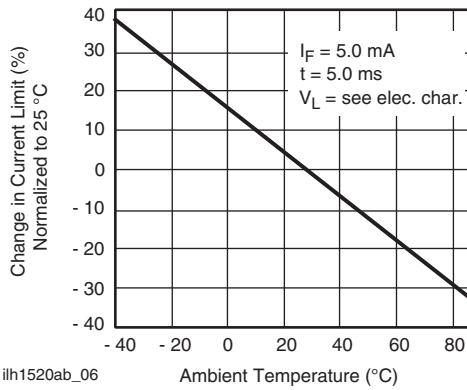

Fig. 7 - Current Limit vs. Temperature

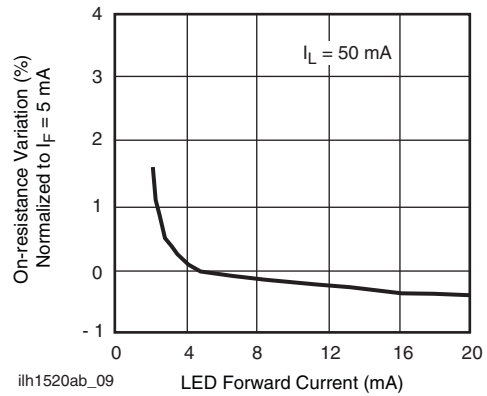

Fig. 10 - Variation in On-resistance vs. LED Current

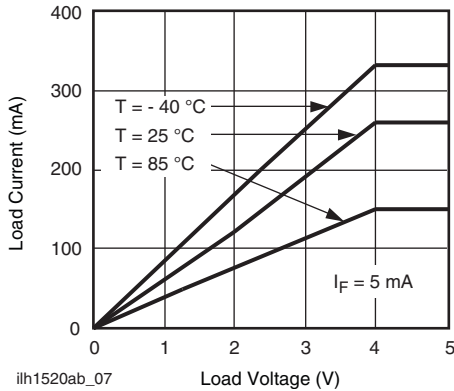

Fig. 8 - Load Current vs. Load Voltage

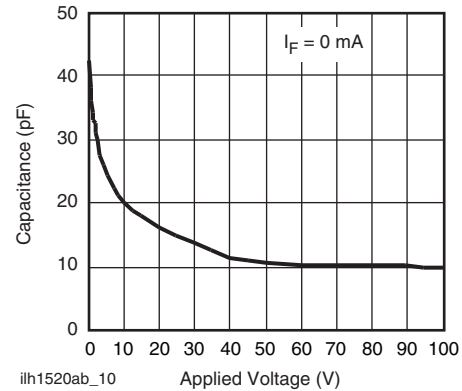

Fig. 11 - Switch Capacitance vs. Applied Voltage

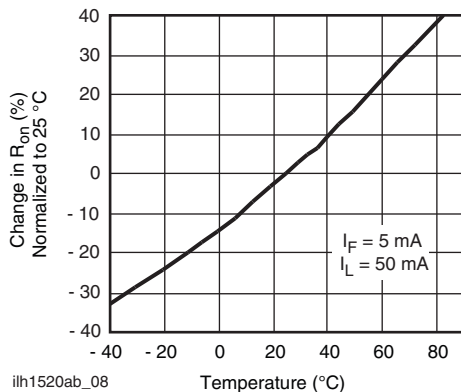

Fig. 9 - On-Resistance vs. Temperature

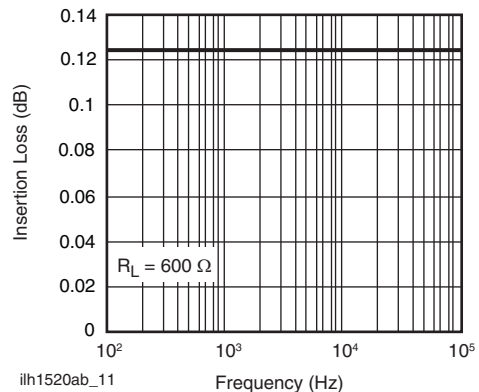
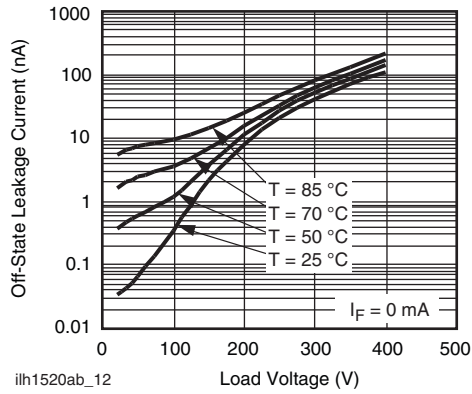
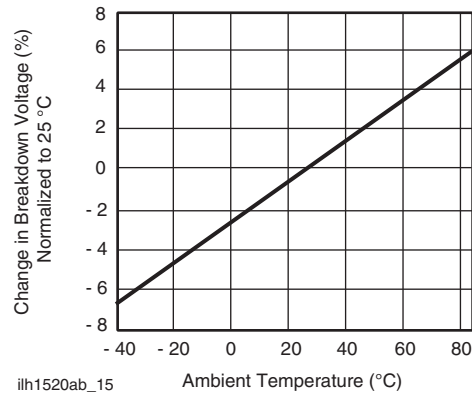

Fig. 12 - Insertion Loss vs. Frequency



ilh1520ab_12

Fig. 13 - Leakage Current vs. Applied Voltage



ilh1520ab_15

Fig. 16 - Switch Breakdown Voltage vs. Temperature

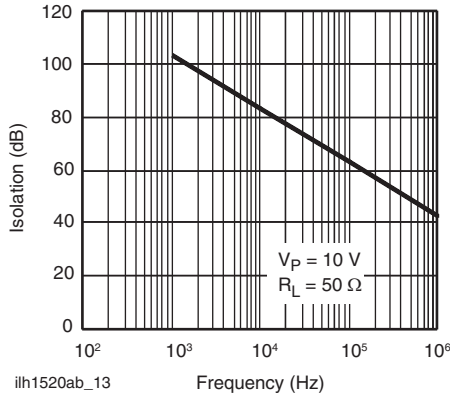

ilh1520ab_13

Fig. 14 - Output Isolation

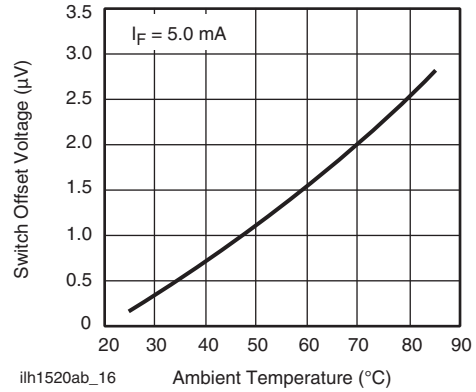

ilh1520ab_16

Fig. 17 - Switch Offset Voltage vs. Temperature

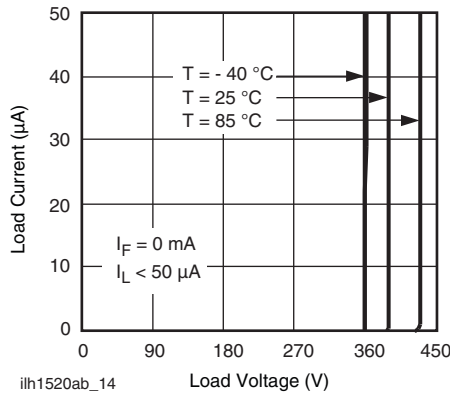

ilh1520ab_14

Fig. 15 - Switch Breakdown Voltage vs. Load Current

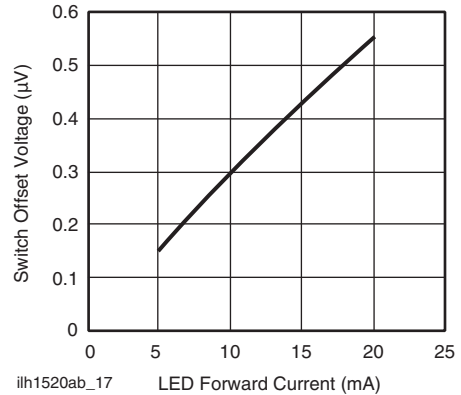

ilh1520ab_17

Fig. 18 - Switch Offset Voltage vs. LED Current

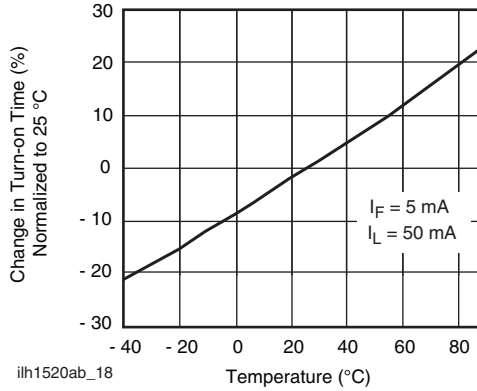

Fig. 19 - Turn-on Time vs. Temperature

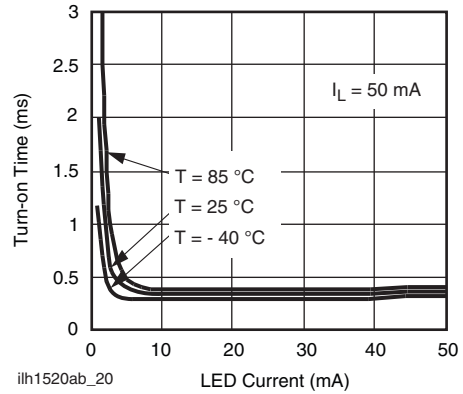

Fig. 21 - Turn-on Time vs. LED Current

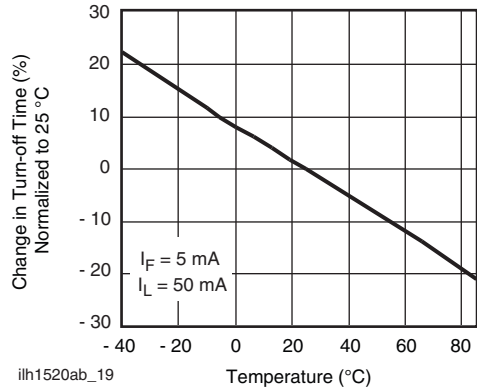

Fig. 20 - Turn-off Time vs. Temperature

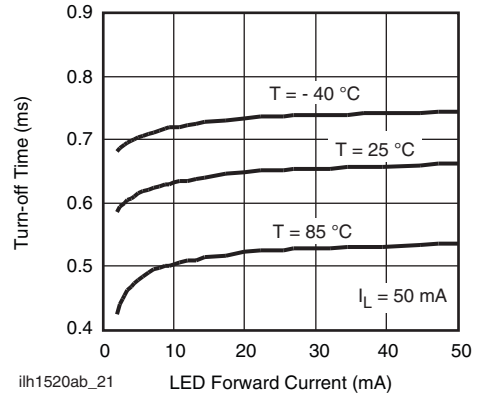
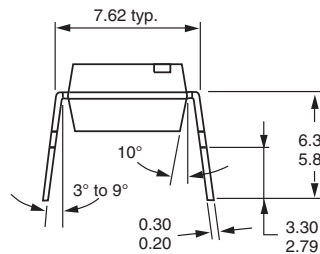
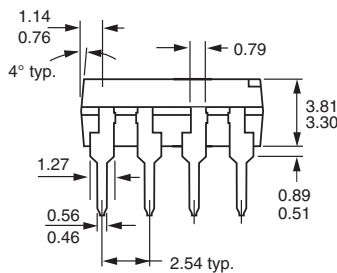
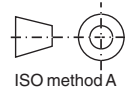
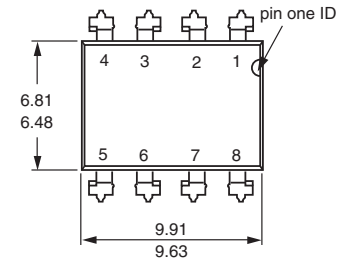

Fig. 22 - Turn-off Time vs. LED Current

PACKAGE DIMENSIONS in millimeters

DIP



i178008

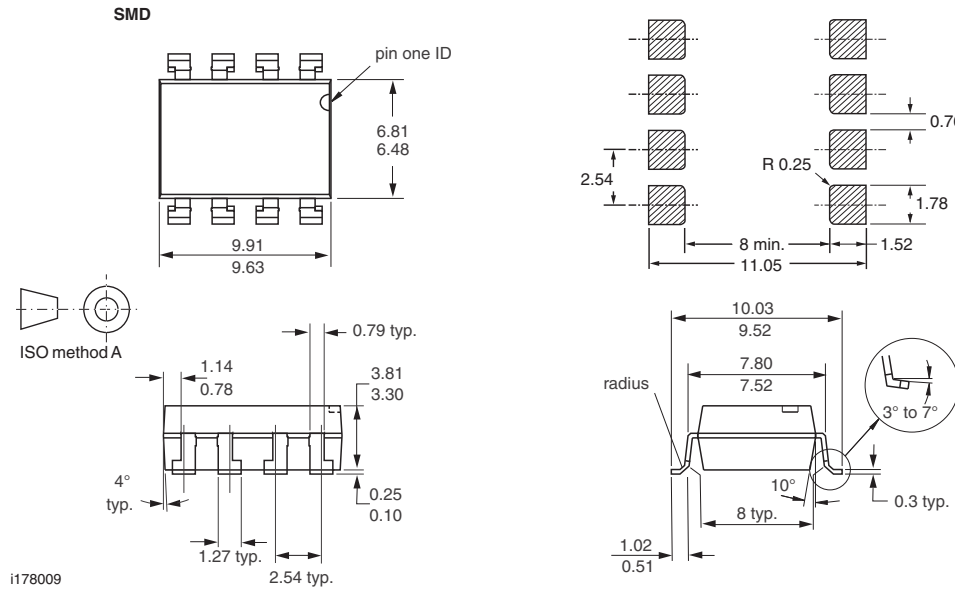

PACKAGE MARKING (example)

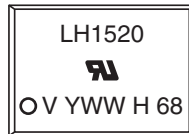

Note

- Tape and reel suffix (TR) is not part of the package marking.



Disclaimer

ALL PRODUCT, PRODUCT SPECIFICATIONS AND DATA ARE SUBJECT TO CHANGE WITHOUT NOTICE TO IMPROVE RELIABILITY, FUNCTION OR DESIGN OR OTHERWISE.

Vishay Intertechnology, Inc., its affiliates, agents, and employees, and all persons acting on its or their behalf (collectively, "Vishay"), disclaim any and all liability for any errors, inaccuracies or incompleteness contained in any datasheet or in any other disclosure relating to any product.

Vishay makes no warranty, representation or guarantee regarding the suitability of the products for any particular purpose or the continuing production of any product. To the maximum extent permitted by applicable law, Vishay disclaims (i) any and all liability arising out of the application or use of any product, (ii) any and all liability, including without limitation special, consequential or incidental damages, and (iii) any and all implied warranties, including warranties of fitness for particular purpose, non-infringement and merchantability.

Statements regarding the suitability of products for certain types of applications are based on Vishay's knowledge of typical requirements that are often placed on Vishay products in generic applications. Such statements are not binding statements about the suitability of products for a particular application. It is the customer's responsibility to validate that a particular product with the properties described in the product specification is suitable for use in a particular application. Parameters provided in datasheets and/or specifications may vary in different applications and performance may vary over time. All operating parameters, including typical parameters, must be validated for each customer application by the customer's technical experts. Product specifications do not expand or otherwise modify Vishay's terms and conditions of purchase, including but not limited to the warranty expressed therein.

Except as expressly indicated in writing, Vishay products are not designed for use in medical, life-saving, or life-sustaining applications or for any other application in which the failure of the Vishay product could result in personal injury or death. Customers using or selling Vishay products not expressly indicated for use in such applications do so at their own risk and agree to fully indemnify and hold Vishay and its distributors harmless from and against any and all claims, liabilities, expenses and damages arising or resulting in connection with such use or sale, including attorneys fees, even if such claim alleges that Vishay or its distributor was negligent regarding the design or manufacture of the part. Please contact authorized Vishay personnel to obtain written terms and conditions regarding products designed for such applications.

No license, express or implied, by estoppel or otherwise, to any intellectual property rights is granted by this document or by any conduct of Vishay. Product names and markings noted herein may be trademarks of their respective owners.

Компания «Океан Электроники» предлагает заключение долгосрочных отношений при поставках импортных электронных компонентов на взаимовыгодных условиях!

Наши преимущества:

- Поставка оригинальных импортных электронных компонентов напрямую с производств Америки, Европы и Азии, а так же с крупнейших складов мира;
- Широкая линейка поставок активных и пассивных импортных электронных компонентов (более 30 млн. наименований);
- Поставка сложных, дефицитных, либо снятых с производства позиций;
- Оперативные сроки поставки под заказ (от 5 рабочих дней);
- Экспресс доставка в любую точку России;
- Помощь Конструкторского Отдела и консультации квалифицированных инженеров;
- Техническая поддержка проекта, помощь в подборе аналогов, поставка прототипов;
- Поставка электронных компонентов под контролем ВП;
- Система менеджмента качества сертифицирована по Международному стандарту ISO 9001;
- При необходимости вся продукция военного и аэрокосмического назначения проходит испытания и сертификацию в лаборатории (по согласованию с заказчиком);
- Поставка специализированных компонентов военного и аэрокосмического уровня качества (Xilinx, Altera, Analog Devices, Intersil, Interpoint, Microsemi, Actel, Aeroflex, Peregrine, VPT, Syfer, Eurofarad, Texas Instruments, MS Kennedy, Miteq, Cobham, E2V, MA-COM, Hittite, Mini-Circuits, General Dynamics и др.);

Компания «Океан Электроники» является официальным дистрибьютором и эксклюзивным представителем в России одного из крупнейших производителей разъемов военного и аэрокосмического назначения «JONHON», а так же официальным дистрибьютором и эксклюзивным представителем в России производителя высокотехнологичных и надежных решений для передачи СВЧ сигналов «FORSTAR».



JONHON

«JONHON» (основан в 1970 г.)

Разъемы специального, военного и аэрокосмического назначения:

(Применяются в военной, авиационной, аэрокосмической, морской, железнодорожной, горно- и нефтедобывающей отраслях промышленности)

«FORSTAR» (основан в 1998 г.)

ВЧ соединители, коаксиальные кабели, кабельные сборки и микроволновые компоненты:

(Применяются в телекоммуникациях гражданского и специального назначения, в средствах связи, РЛС, а так же военной, авиационной и аэрокосмической отраслях промышленности).



Телефон: 8 (812) 309-75-97 (многоканальный)

Факс: 8 (812) 320-03-32

Электронная почта: ocean@oceanchips.ru

Web: <http://oceanchips.ru/>

Адрес: 198099, г. Санкт-Петербург, ул. Калинина, д. 2, корп. 4, лит. А