

Optocoupler, Phototransistor Output, AC Input, with Base Connection

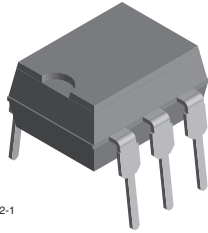

21842-1

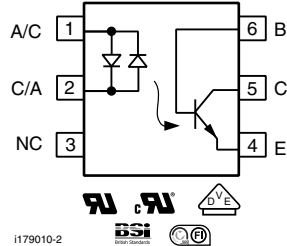

1179010-2



FEATURES

- AC or polarity insensitive input
- Built-in reverse polarity input protection
- I/O compatible with integrated circuits
- Industry standard DIP package
- Isolation test voltage: 5300 V_{RMS}
- Compliant to RoHS Directive 2002/95/EC and in accordance to WEEE 2002/96/EC



RoHS
COMPLIANT

APPLICATIONS

- Telephone line detection
- AC line motor
- PLC
- Instrumentation

AGENCY APPROVALS

- UL1577, file no. E52744 system code H, double protection
- CSA 93751
- BSI IEC 60950; IEC 60065
- DIN EN 60747-5-2 (VDE0884)/DIN EN 60747-5-5 (pending), available with option 1
- FIMKO

DESCRIPTION

The H11AA1 is a bi-directional input optically coupled isolator consisting of two inverse parallel gallium arsenide infrared LEDs coupled to a silicon NPN phototransistor in a 6 pin DIP package. The H11AA1 has a minimum CTR of 20 %, a CTR symmetry of 1:3 and is designed for applications requiring detection or monitoring of AC signals.

ORDERING INFORMATION



AGENCY CERTIFIED/PACKAGE	CTR (%)
UL, cUL, BSI, FIMKO	≥ 20
DIP-6	H11AA1
DIP-6, 400 mil, option 6	H11AA1-X006
SMD-6, option 7	H11AA1-X007T ⁽¹⁾
SMD-6, option 9	H11AA1-X009T ⁽¹⁾
VDE, UL, cUL, BSI, FIMKO	≥ 20
DIP-6	H11AA1-X001

Note

- Additional options may be possible, please contact sales office.
- ⁽¹⁾ Also available in tubes; do not add T to end.

Vishay Semiconductors Optocoupler, Phototransistor Output,
AC Input, with Base Connection

ABSOLUTE MAXIMUM RATINGS ($T_{amb} = 25\text{ }^{\circ}\text{C}$, unless otherwise specified)				
PARAMETER	TEST CONDITION	SYMBOL	VALUE	UNIT
INPUT				
Forward continuous current		I_F	± 60	mA
Power dissipation		P_{diss}	100	mW
Derate linearly from 25 °C			1.3	mW/°C
OUTPUT				
Power dissipation		P_{diss}	200	mW
Derate linearly from 25 °C			2.6	mW/°C
Collector emitter breakdown voltage		BV_{CEO}	30	V
Emitter base breakdown voltage		BV_{EBO}	5	V
Collector base breakdown voltage		BV_{CBO}	70	V
COUPLER				
Isolation test voltage (RMS)	Between emitter and detector, referred to standard climate 23 °C/50% RH, DIN 50014	V_{ISO}	5300	V_{RMS}
Creepage distance			≥ 7	mm
Clearance distance			≥ 7	mm
Comparative tracking index	per DIN IEC 112/VDE 0303, part 1	CTI	175	
Isolation resistance	$V_{IO} = 500\text{ V}$, $T_{amb} = 25\text{ }^{\circ}\text{C}$	R_{IO}	$\geq 10^{12}$	Ω
	$V_{IO} = 500\text{ V}$, $T_{amb} = 100\text{ }^{\circ}\text{C}$	R_{IO}	$\geq 10^{11}$	Ω
Storage temperature range		T_{stg}	- 55 to + 150	°C
Operating temperature range		T_{amb}	- 55 to + 100	°C
Lead soldering time at 260 °C		T_{sld}	10	s

Note

- Stresses in excess of the absolute maximum ratings can cause permanent damage to the device. Functional operation of the device is not implied at these or any other conditions in excess of those given in the operational sections of this document. Exposure to absolute maximum ratings for extended periods of the time can adversely affect reliability.

ELECTRICAL CHARACTERISTICS ($T_{amb} = 25\text{ }^{\circ}\text{C}$, unless otherwise specified)						
PARAMETER	TEST CONDITION	SYMBOL	MIN.	TYP.	MAX.	UNIT
INPUT						
Forward voltage	$I_F = \pm 10\text{ mA}$	V_F		1.2	1.5	V
OUTPUT						
Collector emitter breakdown voltage	$I_C = 1\text{ mA}$	BV_{CEO}	30			V
Emitter base breakdown voltage	$I_E = 100\text{ }\mu\text{A}$	BV_{EBO}	5			V
Collector base breakdown voltage	$I_C = 100\text{ }\mu\text{A}$	BV_{CBO}	70			V
Collector emitter leakage current	$V_{CE} = 10\text{ V}$	I_{CEO}		5	100	nA
COUPLER						
Collector emitter saturation voltage	$I_F = \pm 10\text{ mA}$, $I_C = 0.5\text{ mA}$	V_{CEsat}			0.4	V

Note

- Minimum and maximum values were tested requirements. Typical values are characteristics of the device and are the result of engineering evaluations. Typical values are for information only and are not part of the testing requirements.

CURRENT TRANSFER RATIO ($T_{amb} = 25\text{ }^{\circ}\text{C}$, unless otherwise specified)						
PARAMETER	TEST CONDITION	SYMBOL	MIN.	TYP.	MAX.	UNIT
DC current transfer ratio	$I_F = \pm 10\text{ mA}$, $V_{CE} = 10\text{ V}$	CTR_{DC}	20			%
Symmetry (CTR at + 10 mA)/(CTR at - 10 mA)			0.33	1	3	

TYPICAL CHARACTERISTICS ($T_{amb} = 25\text{ }^{\circ}\text{C}$, unless otherwise specified)



ih11aa1_01
Fig. 1 - LED Forward Current vs. Forward Voltage



ih11aa1_04
Fig. 4 - Normalized Non-Saturated and Saturated CTR vs. LED Current



ih11aa1_02
Fig. 2 - Normalized Non-Saturated and Saturated CTR vs. LED Current



ih11aa1_05
Fig. 5 - Normalized Non-Saturated and Saturated CTR vs. LED Current



ih11aa1_03
Fig. 3 - Normalized Non-Saturated and Saturated CTR vs. LED Current

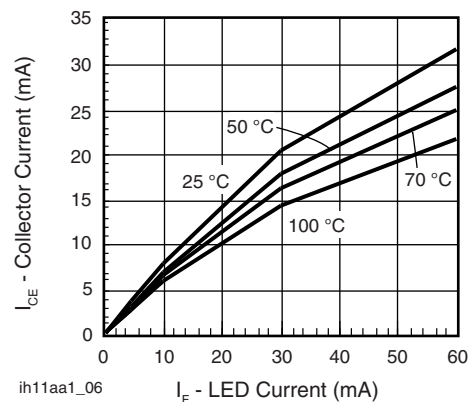

ih11aa1_06
Fig. 6 - Collector Emitter Current vs. Temperature and LED Current



Fig. 7 - Collector Emitter Leakage Current vs. Temperature



Fig. 10 - Normalized Photocurrent vs. LED Current



Fig. 8 - Normalized CTR_{cb} vs. LED Current and Temperature



Fig. 11 - Normalized Saturated h_{FE} vs. Base Current and Temperature



Fig. 9 - Collector Base Photocurrent vs. LED Current



Fig. 12 - Normalized Saturated h_{FE} vs. Base Current and Temperature

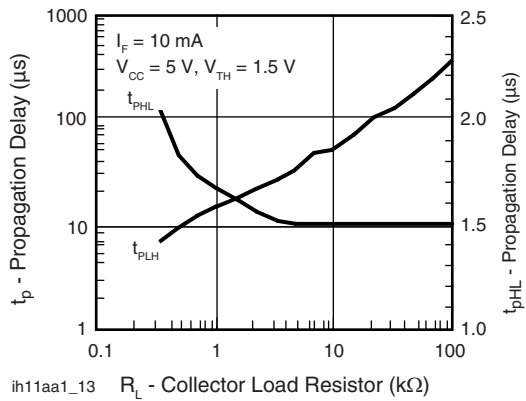
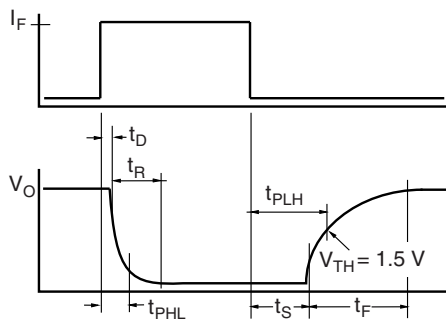

Fig. 13 - Propagation Delay vs. Collector Load Resistor



ih11aa1_14

Fig. 14 - Switching Waveform



ih11aa1_15

Fig. 15 - Switching Schematic

H11AA1



Vishay Semiconductors Optocoupler, Phototransistor Output,
AC Input, with Base Connection

PACKAGE DIMENSIONS in millimeters

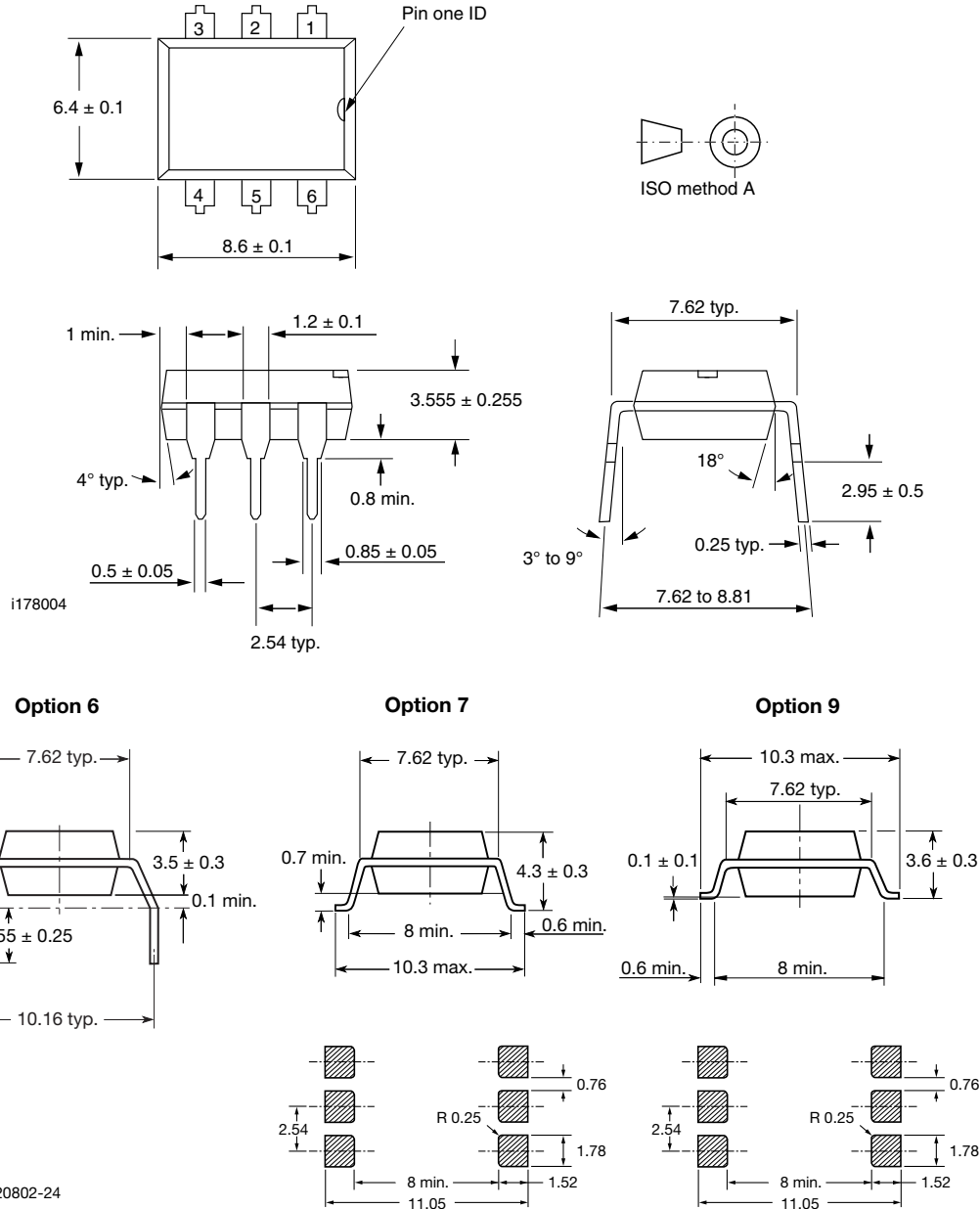

PACKAGE MARKING

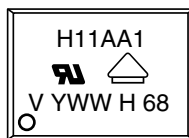

Notes

- Only options 1 and 7 are reflected in the package marking.
- The VDE Logo is only marked on option1 parts.
- Tape and reel suffix (T) is not part of the package marking.



Disclaimer

ALL PRODUCT, PRODUCT SPECIFICATIONS AND DATA ARE SUBJECT TO CHANGE WITHOUT NOTICE TO IMPROVE RELIABILITY, FUNCTION OR DESIGN OR OTHERWISE.

Vishay Intertechnology, Inc., its affiliates, agents, and employees, and all persons acting on its or their behalf (collectively, "Vishay"), disclaim any and all liability for any errors, inaccuracies or incompleteness contained in any datasheet or in any other disclosure relating to any product.

Vishay makes no warranty, representation or guarantee regarding the suitability of the products for any particular purpose or the continuing production of any product. To the maximum extent permitted by applicable law, Vishay disclaims (i) any and all liability arising out of the application or use of any product, (ii) any and all liability, including without limitation special, consequential or incidental damages, and (iii) any and all implied warranties, including warranties of fitness for particular purpose, non-infringement and merchantability.

Statements regarding the suitability of products for certain types of applications are based on Vishay's knowledge of typical requirements that are often placed on Vishay products in generic applications. Such statements are not binding statements about the suitability of products for a particular application. It is the customer's responsibility to validate that a particular product with the properties described in the product specification is suitable for use in a particular application. Parameters provided in datasheets and/or specifications may vary in different applications and performance may vary over time. All operating parameters, including typical parameters, must be validated for each customer application by the customer's technical experts. Product specifications do not expand or otherwise modify Vishay's terms and conditions of purchase, including but not limited to the warranty expressed therein.

Except as expressly indicated in writing, Vishay products are not designed for use in medical, life-saving, or life-sustaining applications or for any other application in which the failure of the Vishay product could result in personal injury or death. Customers using or selling Vishay products not expressly indicated for use in such applications do so at their own risk. Please contact authorized Vishay personnel to obtain written terms and conditions regarding products designed for such applications.

No license, express or implied, by estoppel or otherwise, to any intellectual property rights is granted by this document or by any conduct of Vishay. Product names and markings noted herein may be trademarks of their respective owners.

Material Category Policy

Vishay Intertechnology, Inc. hereby certifies that all its products that are identified as RoHS-Compliant fulfill the definitions and restrictions defined under Directive 2011/65/EU of The European Parliament and of the Council of June 8, 2011 on the restriction of the use of certain hazardous substances in electrical and electronic equipment (EEE) - recast, unless otherwise specified as non-compliant.

Please note that some Vishay documentation may still make reference to RoHS Directive 2002/95/EC. We confirm that all the products identified as being compliant to Directive 2002/95/EC conform to Directive 2011/65/EU.

Vishay Intertechnology, Inc. hereby certifies that all its products that are identified as Halogen-Free follow Halogen-Free requirements as per JEDEC JS709A standards. Please note that some Vishay documentation may still make reference to the IEC 61249-2-21 definition. We confirm that all the products identified as being compliant to IEC 61249-2-21 conform to JEDEC JS709A standards.

Компания «Океан Электроники» предлагает заключение долгосрочных отношений при поставках импортных электронных компонентов на взаимовыгодных условиях!

Наши преимущества:

- Поставка оригинальных импортных электронных компонентов напрямую с производств Америки, Европы и Азии, а так же с крупнейших складов мира;
- Широкая линейка поставок активных и пассивных импортных электронных компонентов (более 30 млн. наименований);
- Поставка сложных, дефицитных, либо снятых с производства позиций;
- Оперативные сроки поставки под заказ (от 5 рабочих дней);
- Экспресс доставка в любую точку России;
- Помощь Конструкторского Отдела и консультации квалифицированных инженеров;
- Техническая поддержка проекта, помощь в подборе аналогов, поставка прототипов;
- Поставка электронных компонентов под контролем ВП;
- Система менеджмента качества сертифицирована по Международному стандарту ISO 9001;
- При необходимости вся продукция военного и аэрокосмического назначения проходит испытания и сертификацию в лаборатории (по согласованию с заказчиком);
- Поставка специализированных компонентов военного и аэрокосмического уровня качества (Xilinx, Altera, Analog Devices, Intersil, Interpoint, Microsemi, Actel, Aeroflex, Peregrine, VPT, Syfer, Eurofarad, Texas Instruments, MS Kennedy, Miteq, Cobham, E2V, MA-COM, Hittite, Mini-Circuits, General Dynamics и др.);

Компания «Океан Электроники» является официальным дистрибьютором и эксклюзивным представителем в России одного из крупнейших производителей разъемов военного и аэрокосмического назначения «JONHON», а так же официальным дистрибьютором и эксклюзивным представителем в России производителя высокотехнологичных и надежных решений для передачи СВЧ сигналов «FORSTAR».



JONHON

«JONHON» (основан в 1970 г.)

Разъемы специального, военного и аэрокосмического назначения:

(Применяются в военной, авиационной, аэрокосмической, морской, железнодорожной, горно- и нефтедобывающей отраслях промышленности)

«FORSTAR» (основан в 1998 г.)

ВЧ соединители, коаксиальные кабели, кабельные сборки и микроволновые компоненты:

(Применяются в телекоммуникациях гражданского и специального назначения, в средствах связи, РЛС, а так же военной, авиационной и аэрокосмической отраслях промышленности).



Телефон: 8 (812) 309-75-97 (многоканальный)

Факс: 8 (812) 320-03-32

Электронная почта: ocean@oceanchips.ru

Web: <http://oceanchips.ru/>

Адрес: 198099, г. Санкт-Петербург, ул. Калинина, д. 2, корп. 4, лит. А