

## Introduction

This user guide describes how to get started with the Atmel® ZigBit® USB sticks.

The ZigBit USB sticks is targeted for evaluating the USB features of the Atmel ZigBits, currently supporting the XMEGA® with AT86RF212B or AT86RF233 radio transceivers.

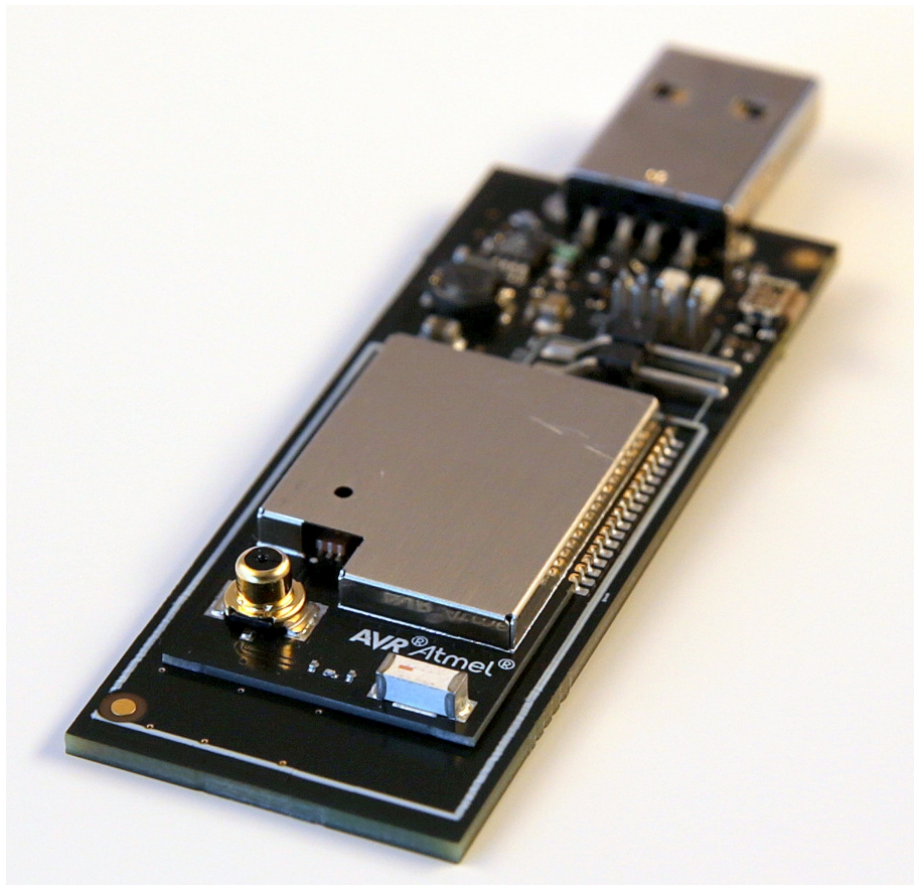

## Table of Contents

---

Introduction .....	1
<b>1. Getting Started .....</b>	<b>3</b>
1.1. Features .....	3
1.2. Design Documentation and Related Links .....	3
1.3. Programming .....	3
1.3.1. JTAGICE .....	3
1.3.2. Bootloader .....	3
1.4. Available Example Code .....	8
<b>2. Performance Analyzer .....</b>	<b>10</b>
2.1. Introduction .....	10
2.2. Program Installation .....	10
2.3. Program Use .....	13
2.4. Typical Wireless Nodes .....	13
<b>3. WireShark .....</b>	<b>15</b>
3.1. Introduction .....	15
3.2. Program Installation .....	15
3.2.1. WireShark Installation .....	15
3.2.2. Sniffer Interface Installation .....	16
3.2.3. Sniffer FW Installation .....	17
3.3. Program Use .....	17
<b>4. Hardware User Guide .....</b>	<b>22</b>
4.1. Board Overview .....	22
4.2. Headers and Connectors .....	22
4.2.1. JTAG (J2) .....	22
4.2.2. Boot Select (J3) .....	23
4.3. Board GUI .....	23
4.3.1. LED's .....	23
4.3.2. Button .....	23
4.4. Factory Programmed Data .....	23
<b>5. Persistence Memory .....</b>	<b>24</b>
<b>6. Document Revision History .....</b>	<b>25</b>

# 1. Getting Started

## 1.1 Features

The ZigBit® USB sticks demonstrates the XMEGA® ZigBits USB features providing a development/prototype platform.

By using the WireShark sniffer FW the ZigBit USB stick's serve as a protocol analyzer.

## 1.2 Design Documentation and Related Links

The following list contains links to the most relevant documents and software for the USB sticks.

1. 2.4GHz USB stick: <http://www.atmel.com/tools/ZB-X-233-USB.aspx>
2. Sub GHz USB stick: <http://www.atmel.com/tools/ZB-X-212B-USB.aspx>
3. ZigBit: <http://www.atmel.com/ZigBit>

## 1.3 Programming

How to program the extension.

### 1.3.1 JTAGICE

How to program using the AVR® JTAGICE mkII and JTAGICE3.

1. Connect the JTAGICE USB to the PC.
2. Connect the JTAGICE to the USB stick connector (J2) as shown on picture.
3. Go to Atmel Studio: Tools/Device Programming, and select the JTAGICE connected as Tool and click Apply.
4. Select Device = ATxmega256A3U.
5. Select "Memories" and locate the source hex or elf file and click Program.

JTAGICE3 connected to J2

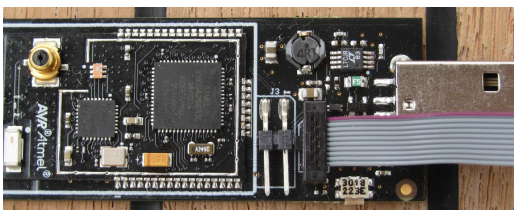

AVR JTAGICE mkII connected to J2

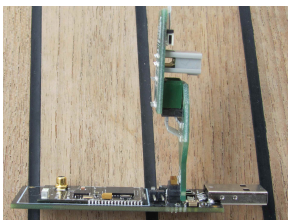

### 1.3.2 Bootloader

This section describes how to use the bootloader to program the ZigBit on the USBstick.

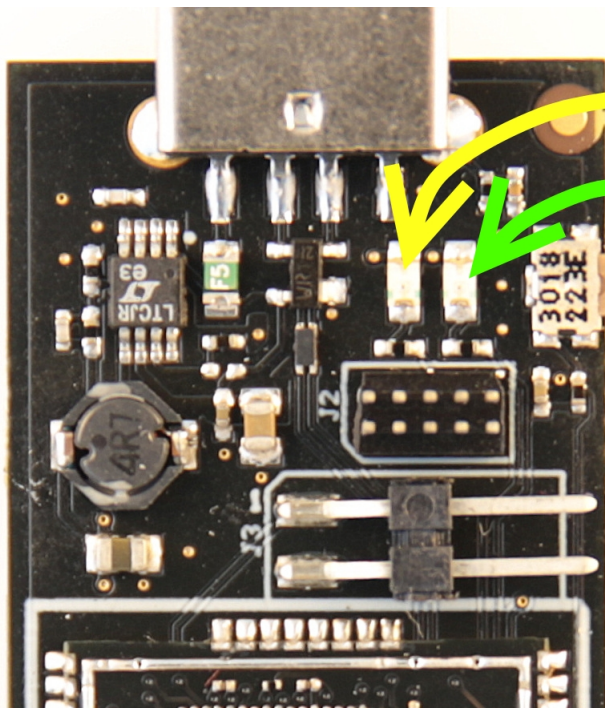

LED0: Yellow

LED1: Green

RESET switch

J2: JTAG programming header

J3: Boot jumper

1. Install the Bootloader interface on the PC as described in "[How to Install the "Bootloader PC tool"](#)" on page 4.
2. Start the Bootloader PC GUI "FLIP" .
3. Insert a jumper on header J3 .  
Insert the USB stick in the PC.  
Press the reset button.
4. Select Device = ATxmega256A3U (Device - Select).
5. Select USB communication (**Ctrl+U**).
6. Select memory area to program (Use the toggle memory button bellow the Atmel logo).
7. Select Load Hex file (**Ctrl+L**).
8. Select Programming Options.
9. Click "Run", observe status in status field .

#### 1.3.2.1 How to Install the "Bootloader PC tool"

How to install the Bootloader PC GUI tool,

1. Download the Flip "in system programming tool" installer from <http://www.atmel.com/tools/FLIP.aspx><sup>1</sup>

<sup>1</sup> <http://www.atmel.com/tools/FLIP.aspx>

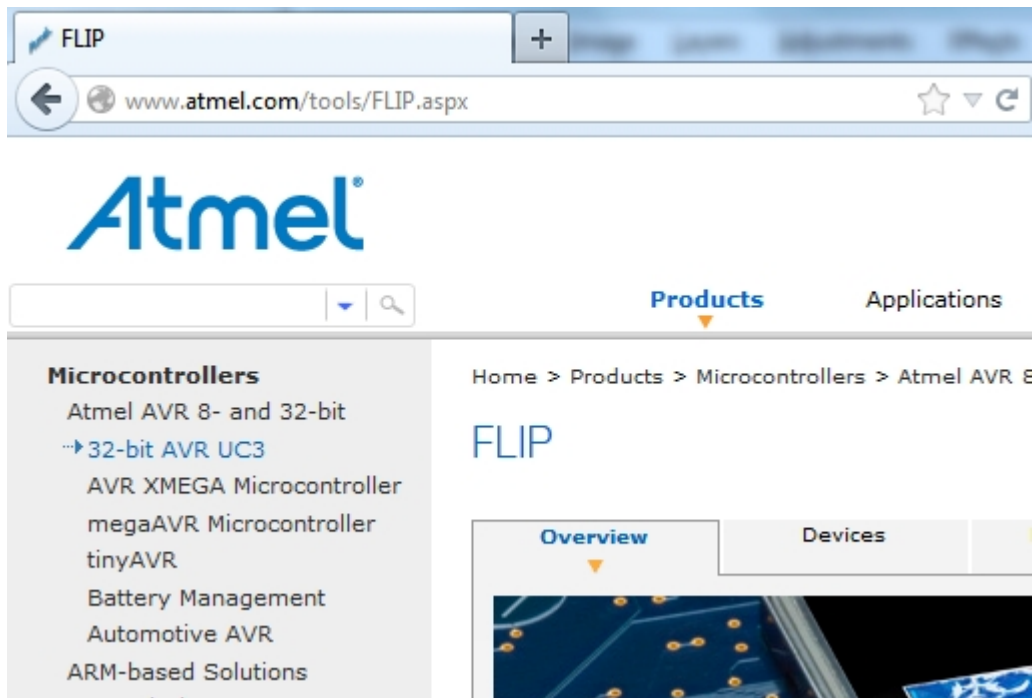

2. Run the Flip Installer .



3. Download the Atmel USB extension and run the installer.

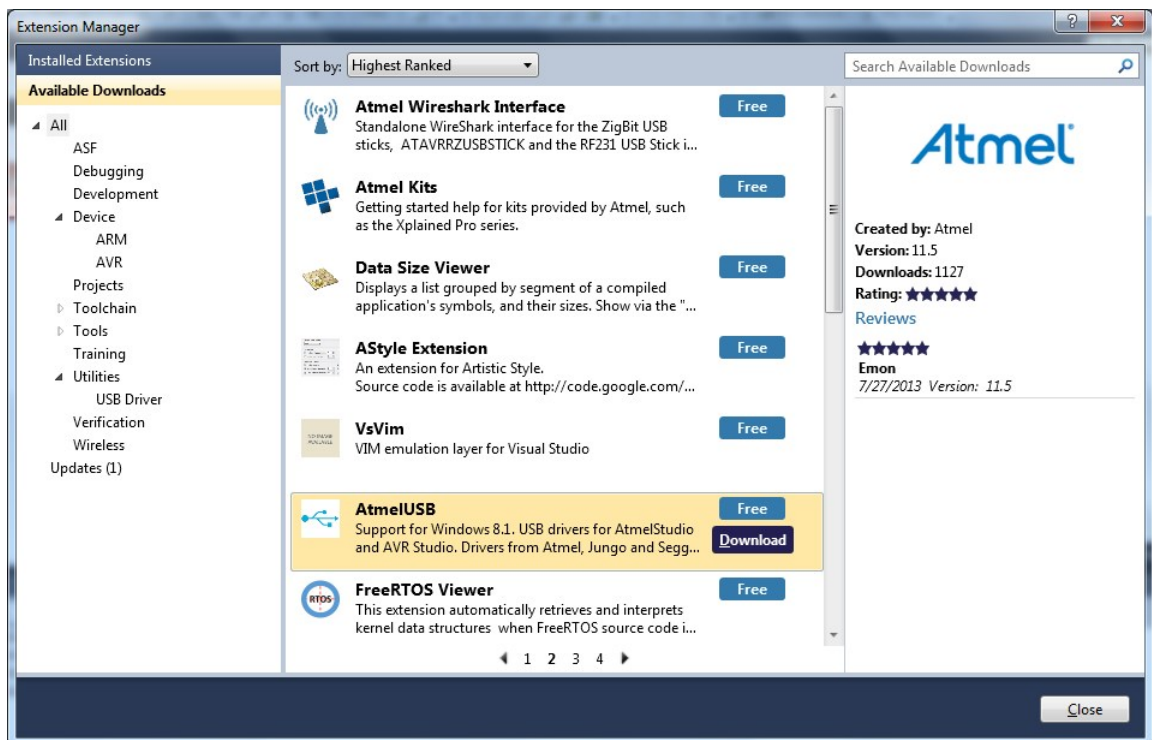
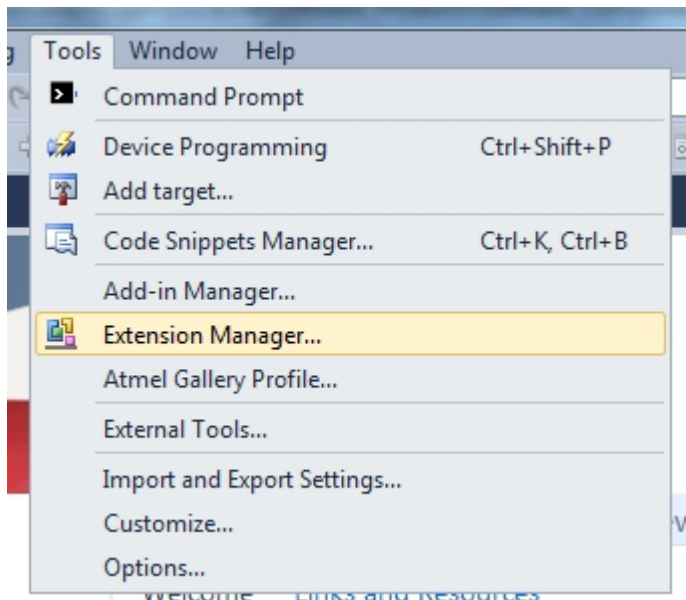

4. Start Flip - if the USBstick is not recognized continue with step 5.
5. Update the USB DFU driver.

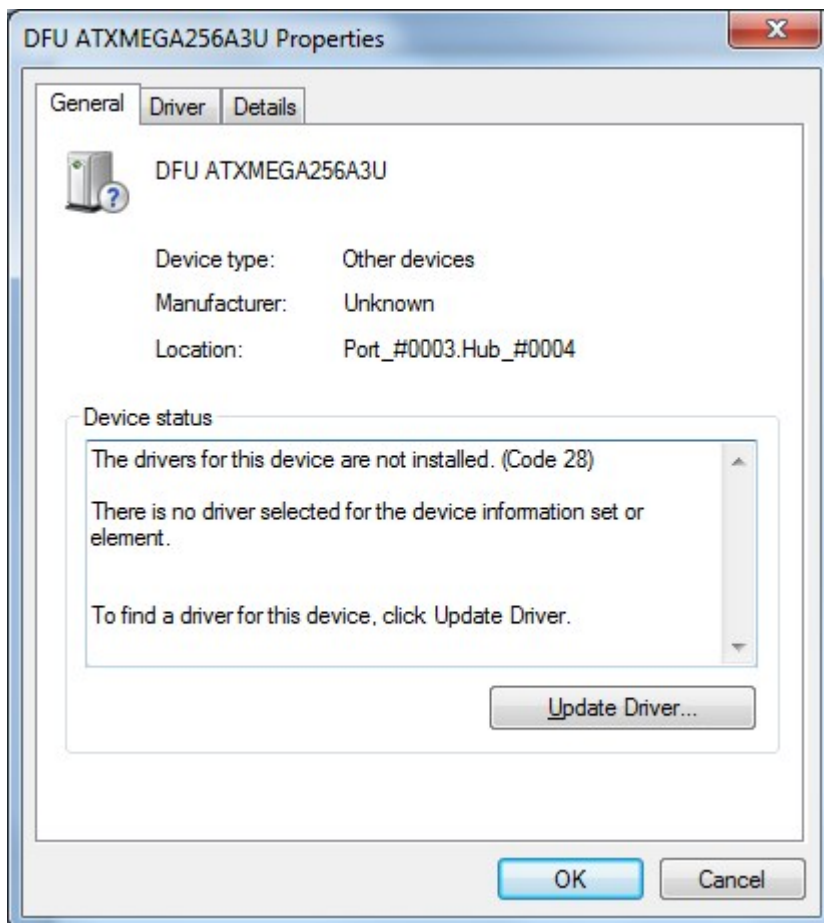
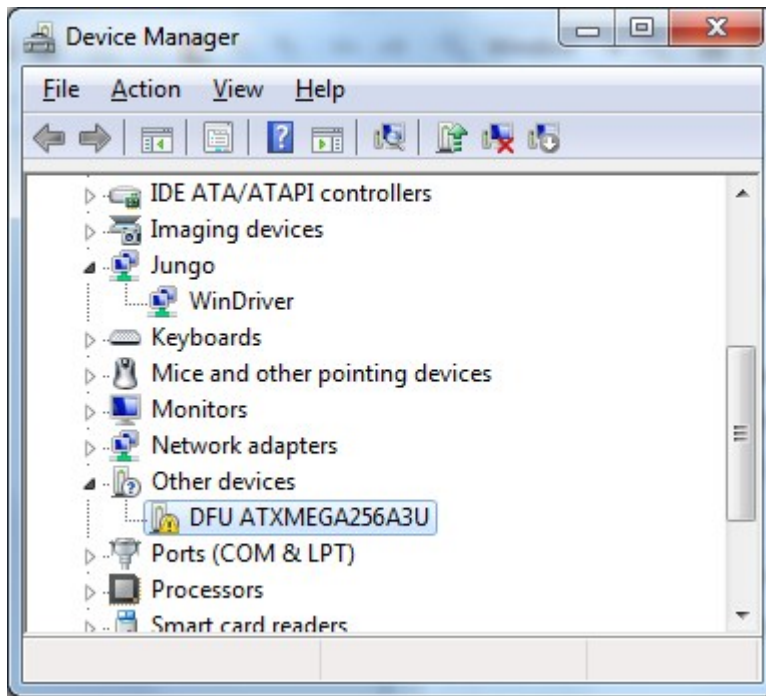

Click the Update Driver button and select "Browse my computer-..."

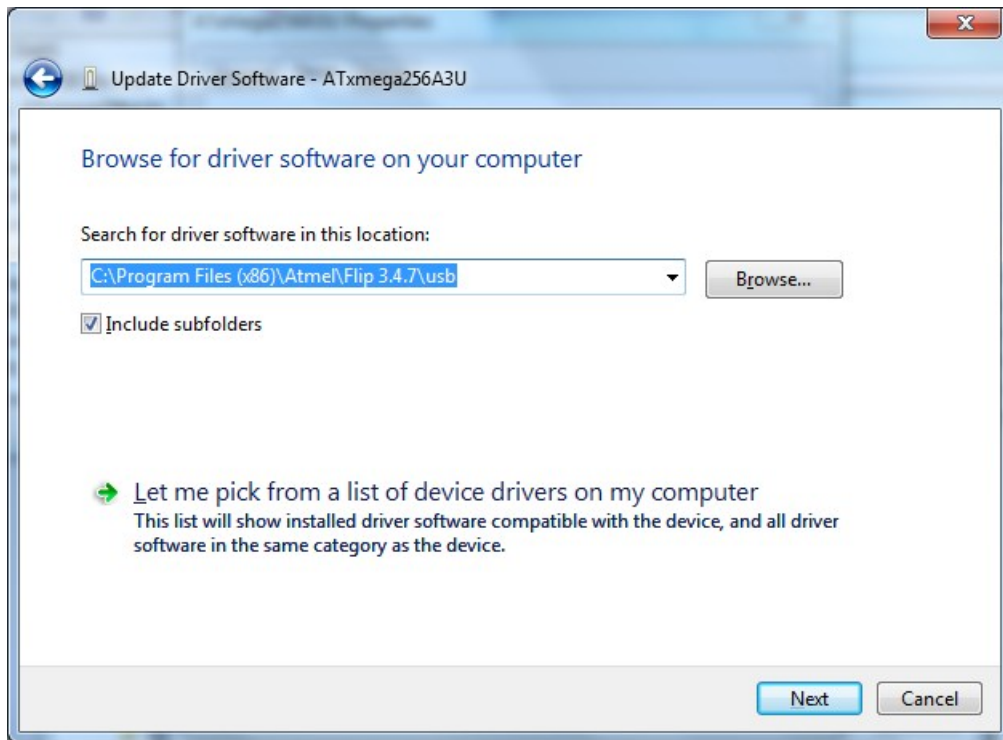

## 1.4 Available Example Code

ASF contains a number of Wireless example projects with source code - use Wireless as key word and select from the list.



Figure 1-1. NewProjectASF.jpg

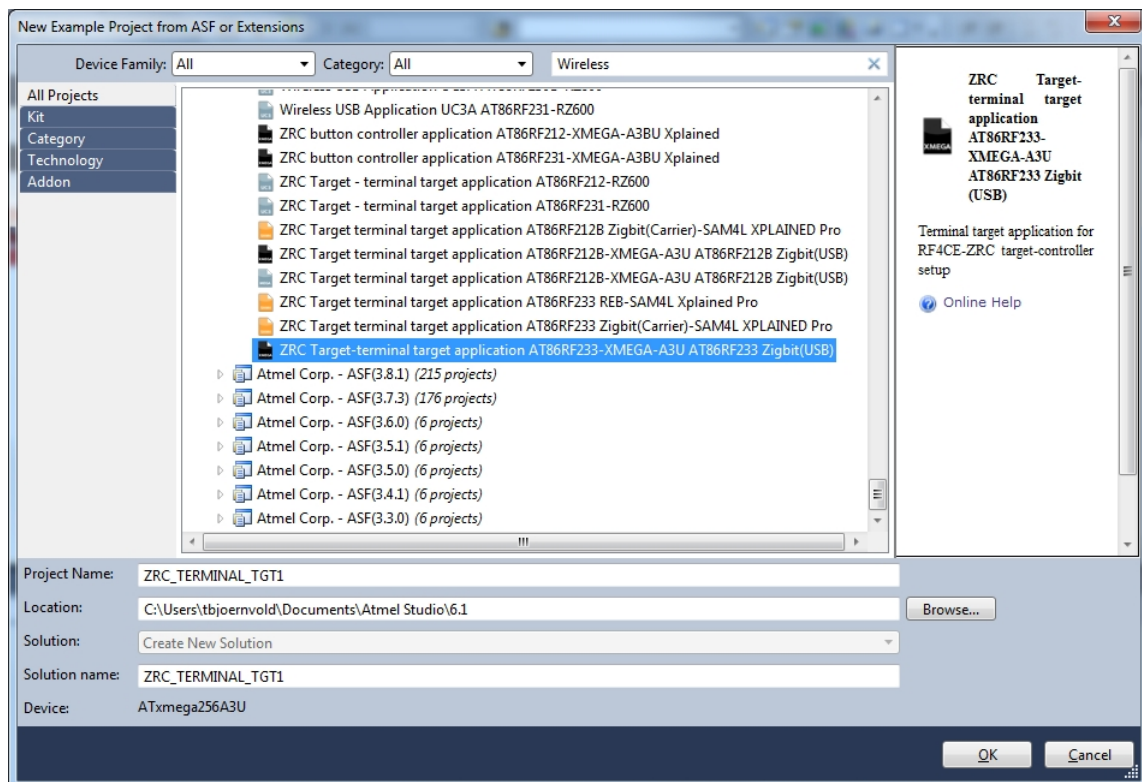
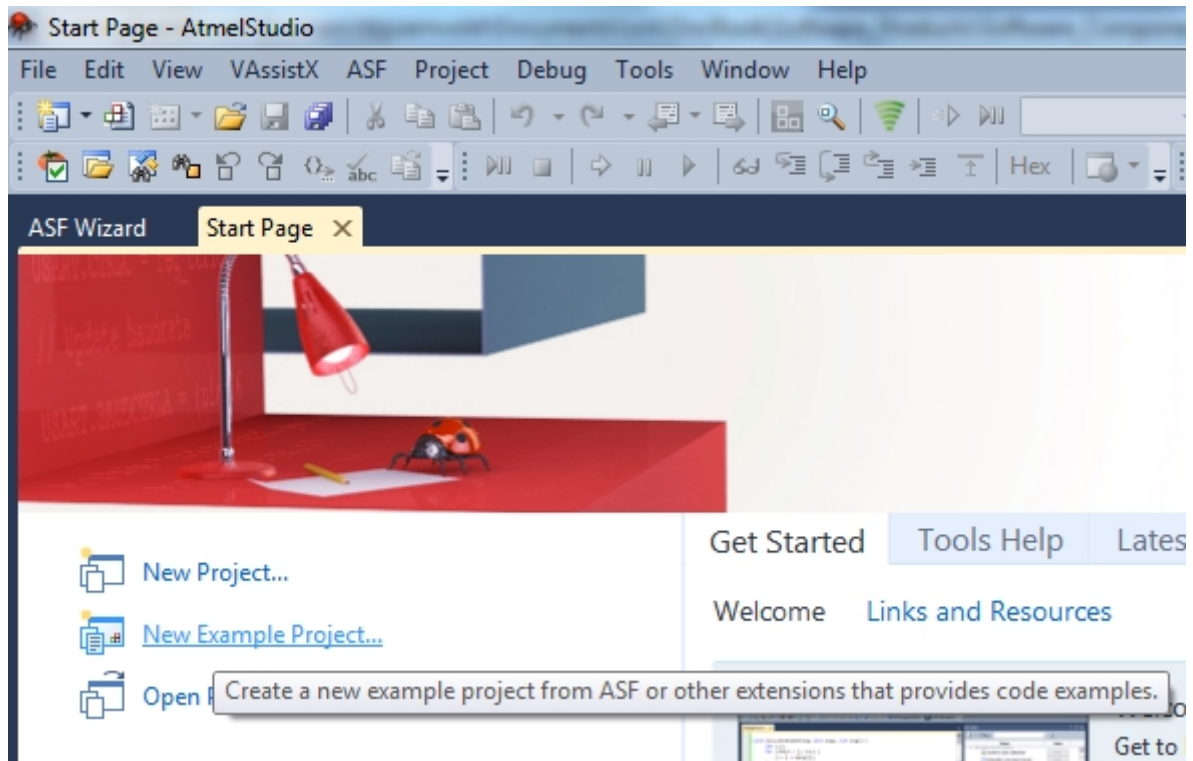

## 2. Performance Analyzer

### 2.1 Introduction

The Performance Analyzer FW together with the GUI in Atmel Studio Wireless Composer Extension provides a number of basic functional RF tests.

A quick start guide and general help is provided in Wireless Composer once started.

### 2.2 Program Installation

How to install necessary SW.

1. Install [Atmel Studio](http://www.atmel.com/tools/atmelstudio.aspx)<sup>1</sup>.
2. Once Studio is installed and started use the Tools - Extension Manager to install the Wireless Composer.

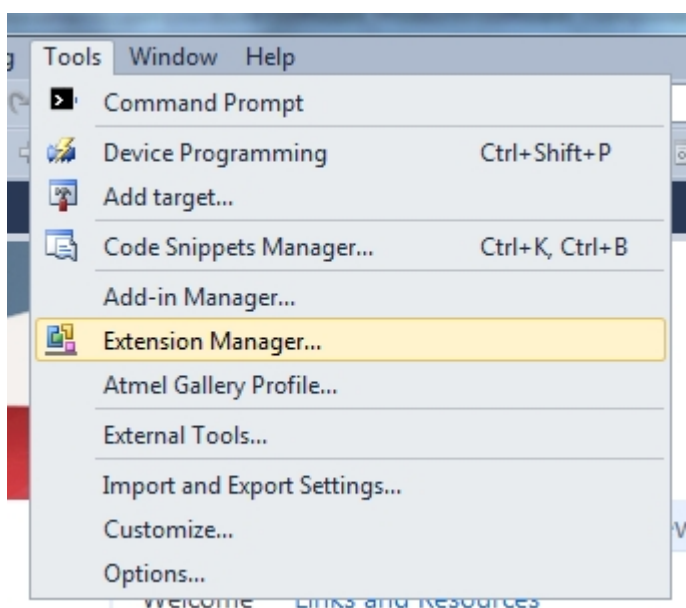

Select Wireless and Wireless Composer.

<sup>1</sup> <http://www.atmel.com/tools/atmelstudio.aspx>

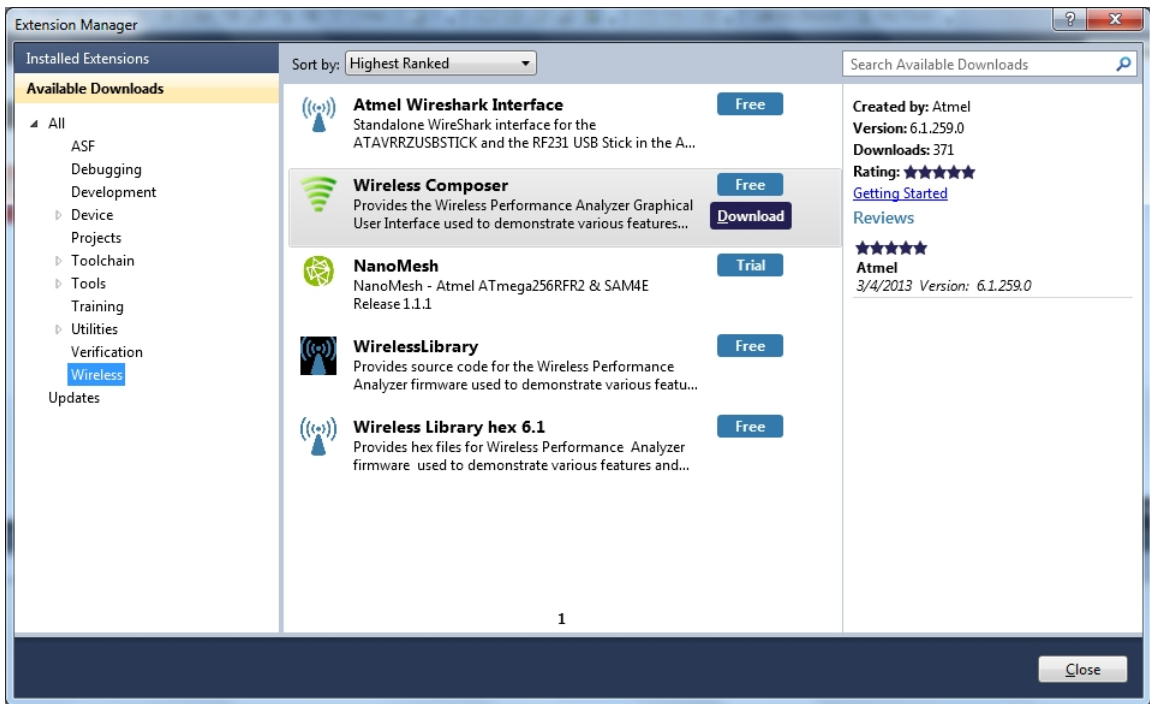

Log in to Atmel Gallery.

Click download again and download starts.

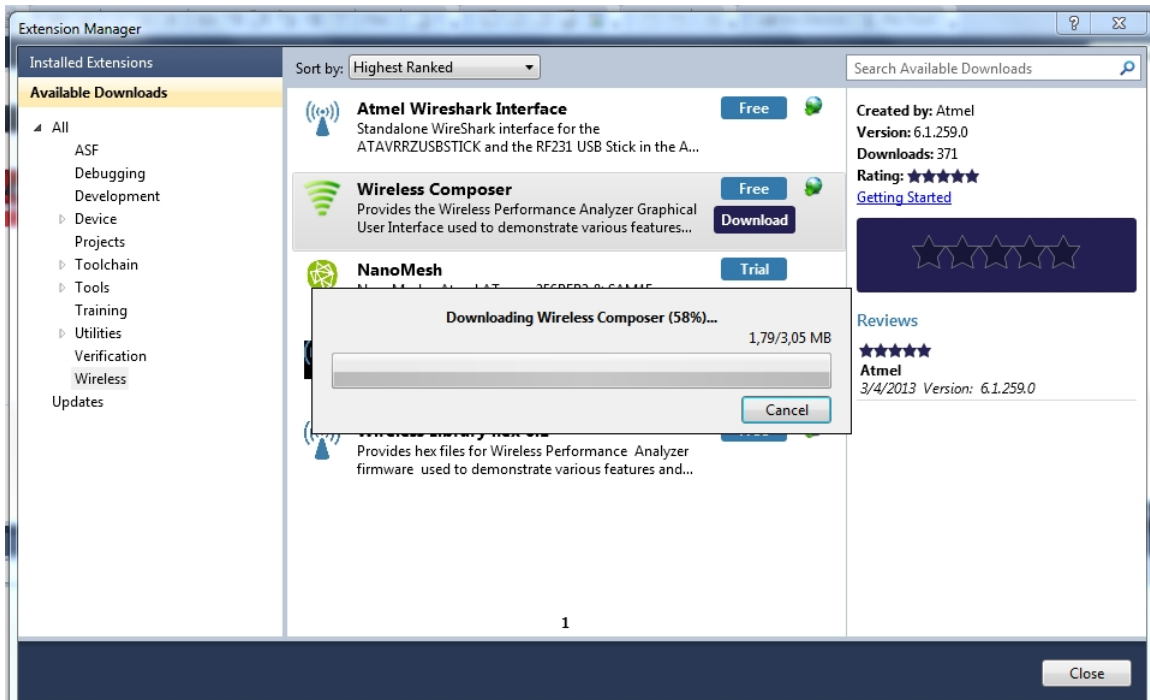

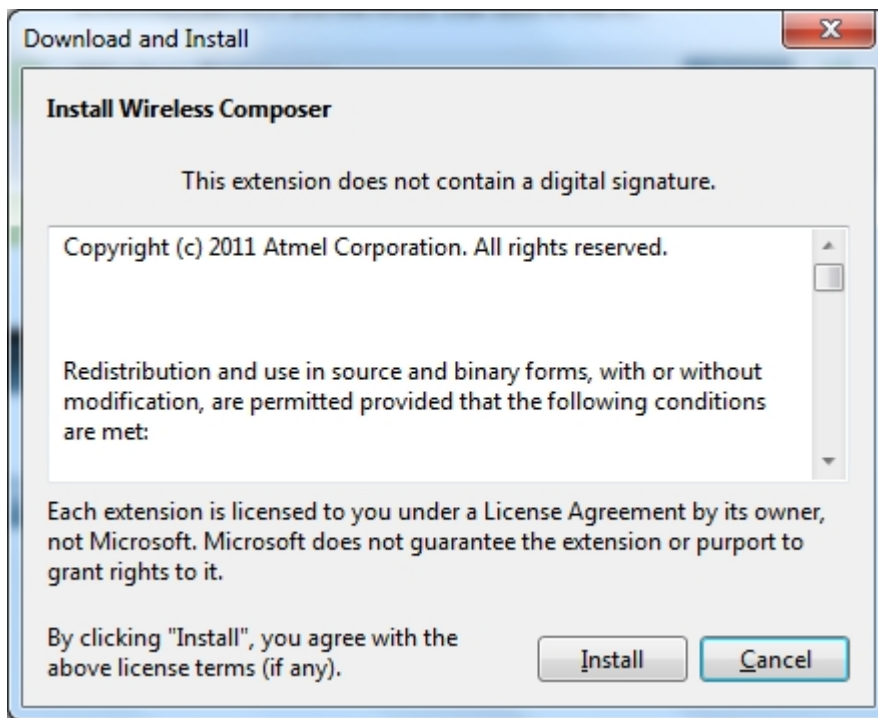

Restart Atmel Studio, allow help to make changes and the Performance Analyzer GUI is available in the Tools menu.

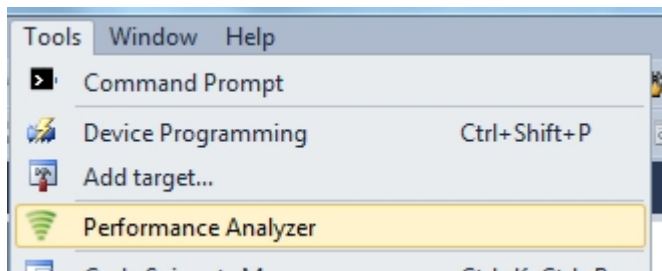

3. If not already preprogrammed - program the node with the Performance Analyzer FW available in the "Wireless Performance Analyzer Firmware extension" or from source code provided in ASF.

If using an Wireless board with a  $\mu$ C embedded, the Performance Analyzer FW has to be programmed using the Bootloader or JTAGICE.

If using a extension board which do not have a  $\mu$ C embedded, the Performance Analyzer FW has to be programmed on the Xplained Pro board using the EBDG from Atmel Studio.

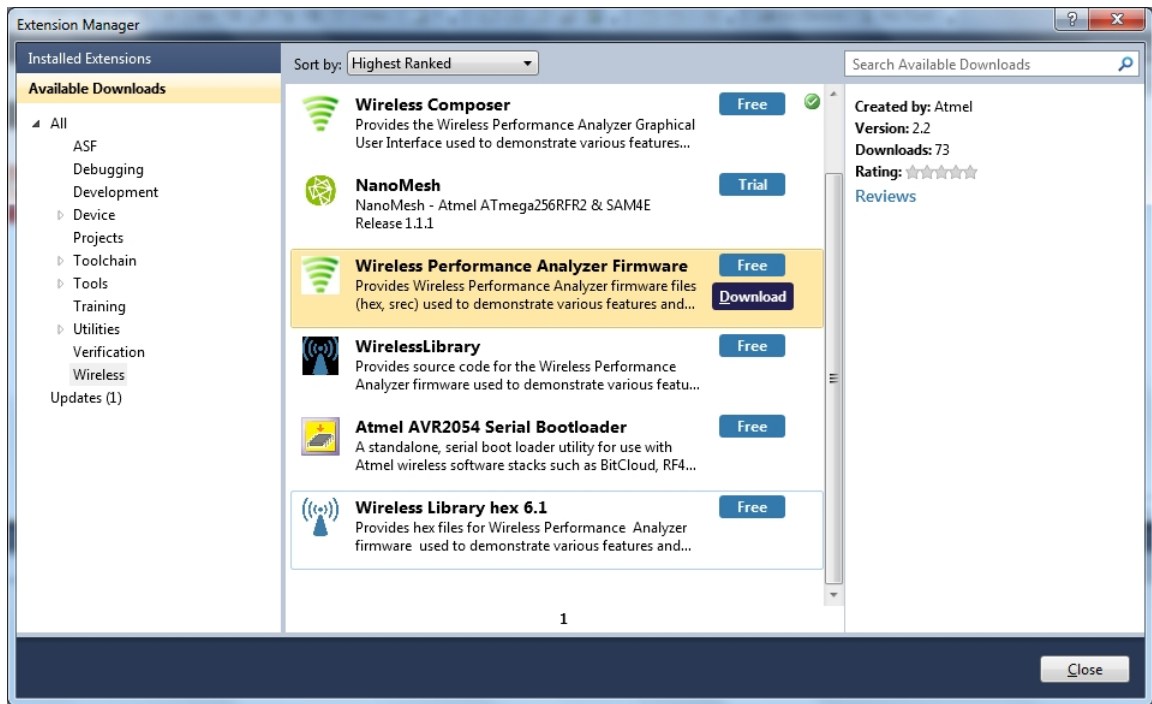

## 2.3 Program Use

How to get started.

1. Connect the Wireless board assembly, with the Performance Analyzer FW programmed, to the PC USB connector and power on, a COM port should now be available for the kit.
2. Power on any other wireless node assemblies of similar frequency, running the Performance Analyzer FW, and use it as a reference.
3. Start Performance Analyzer GUI, connect to the kit via the COM port and follow the quick start guide.

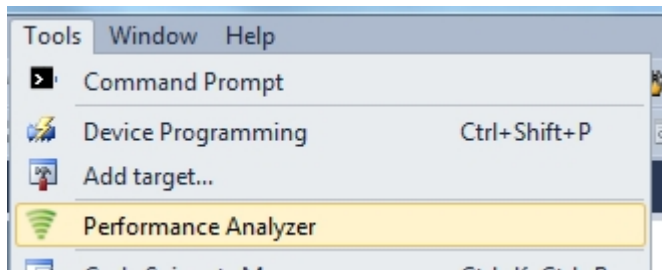

## 2.4 Typical Wireless Nodes

Typical board assembly.

The Atmel SAM4L Xplained Pro Evaluation Kit with Wireless Extension and remote node consisting of a Wireless extension board and a battery pack.

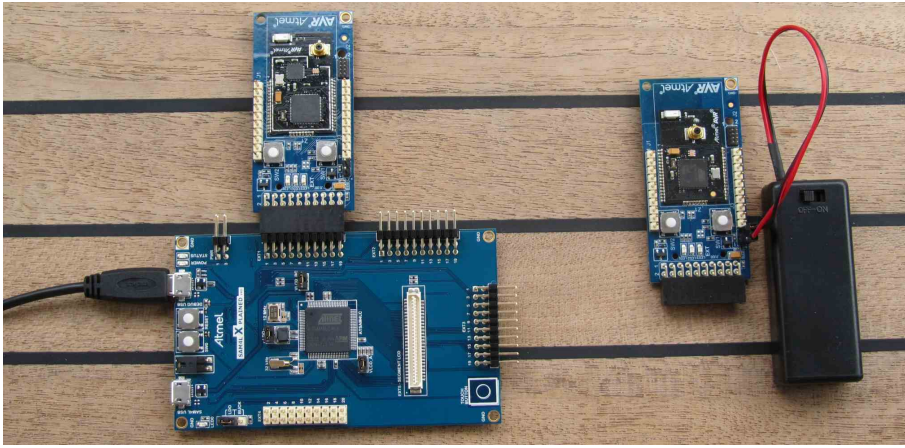

The Atmel ATmega256RFR2 Xplained Pro Evaluation Kit and remote node consisting of a Wireless extension board and a battery pack.

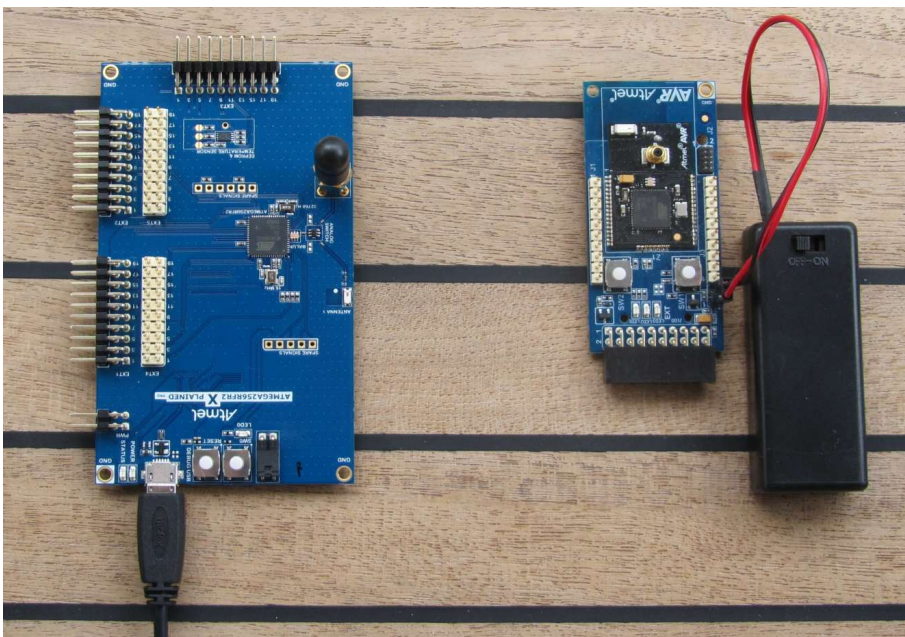

### 3. WireShark

#### 3.1 Introduction

Wireshark is a free and open-source packet analyzer. It is used for network troubleshooting, analysis, software and communications protocol development.

Atmel provides an interface enabling use of WireShark GUI to monitor wireless communication using Atmel RF USB sticks.

Go to the [WireShark home page](http://www.wireshark.org)<sup>1</sup> to learn the detail on how to use WireShark.

#### 3.2 Program Installation

How to install necessary SW and FW.

##### 3.2.1 WireShark Installation

How to install the WireShark analyzer.

1. Go to the [WireShark home page](http://www.wireshark.org)<sup>2</sup> and download the WireShark installer.

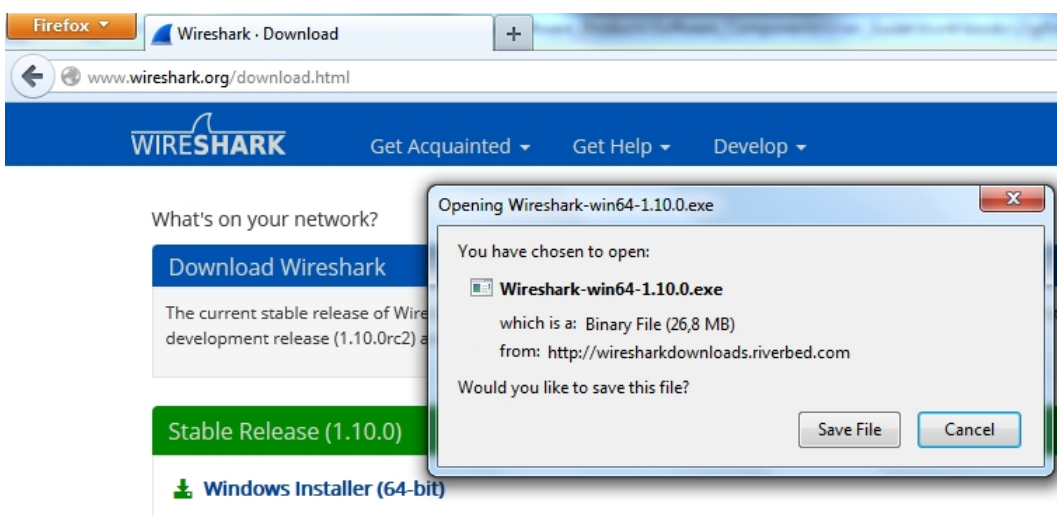
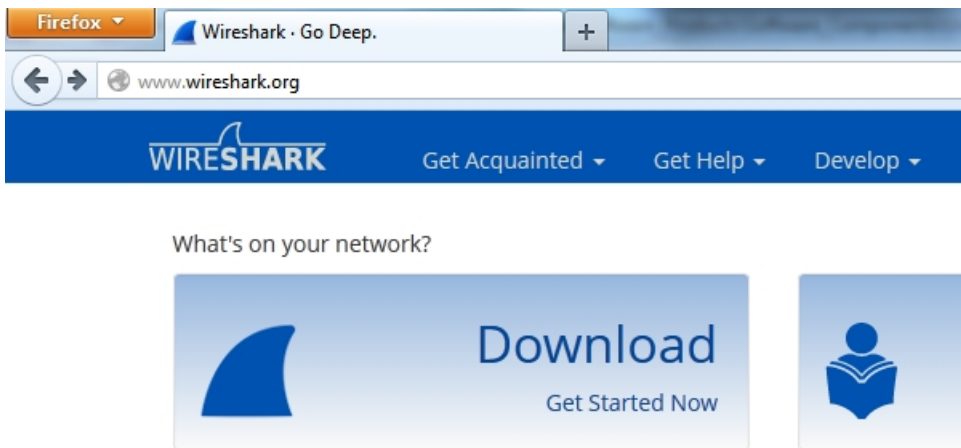

2. Locate the downloaded installer and install WireShark.

<sup>1</sup> <http://www.wireshark.org>

<sup>2</sup> <http://www.wireshark.org>



### 3.2.2 Sniffer Interface Installation

How to install the WireShark sniffer interface, connecting the WireShark GUI and the sniffer FW running on the USB stick.

The sniffer interface program can be downloaded from Atmel Gallery.

1. Install [Atmel Studio](http://www.atmel.com/tools/atmelstudio.aspx)<sup>3</sup>.
2. Once Studio is installed and started use the Extension Manager to download the Atmel WireShark Interface installer.

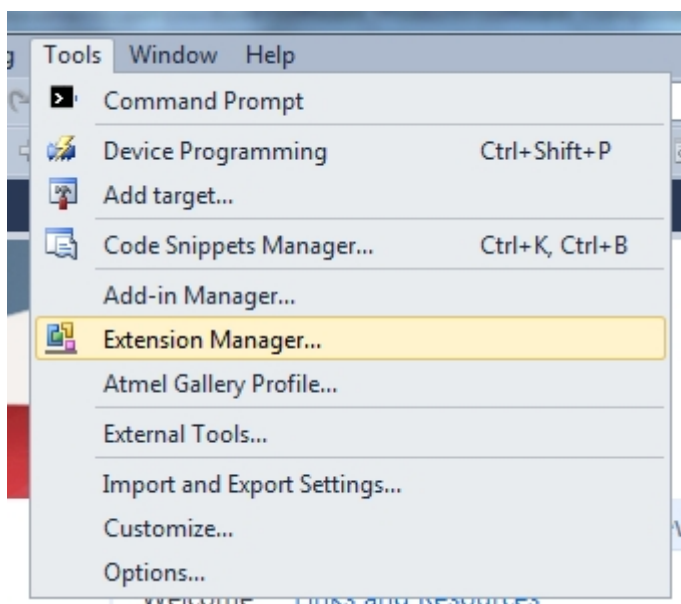

3. Select Wireless and Atmel WireShark Interface.

<sup>3</sup> <http://www.wireshark.orghttp://www.atmel.com/tools/atmelstudio.aspx>



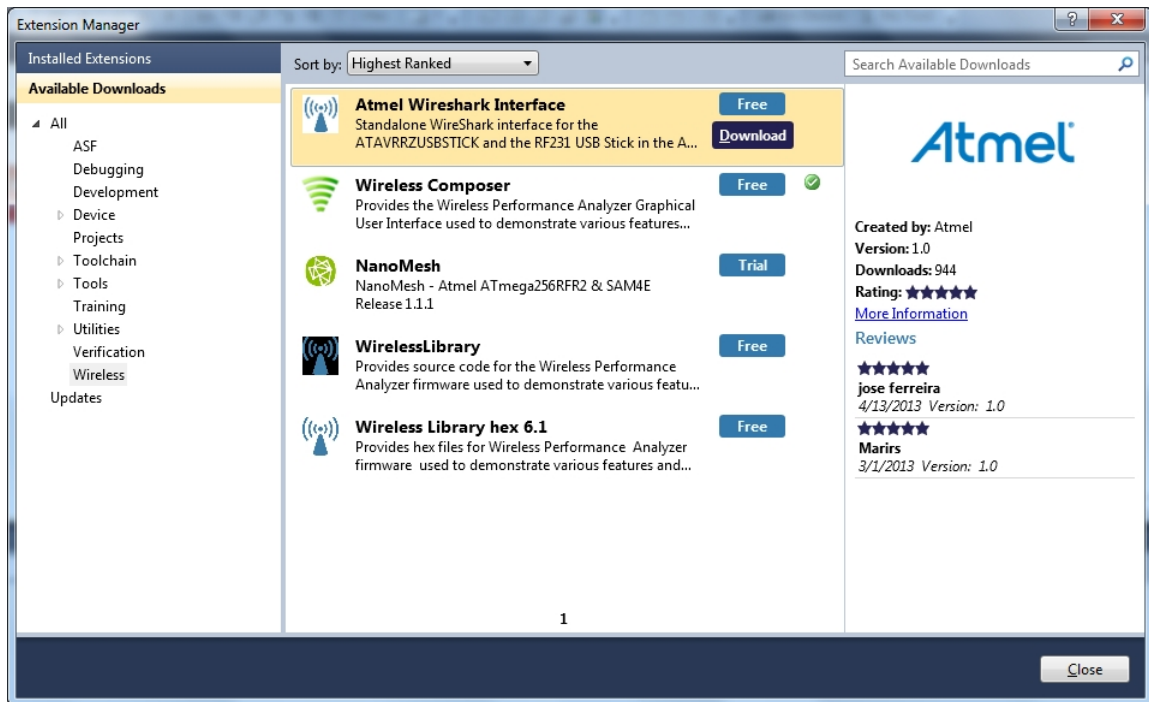

4. Log in to Atmel Gallery if not already logged in.
5. Click download again and download starts.
6. You have now downloaded the Atmel WireShark installer, AtmelWiresharkFirmwareSetup.msi, run the installer.
7. You now have the "Wireshark Sniffer" user interface in the Start Menu - All Programs - Atmel folder and the sniffer firmware files located in C:/Program Files (x86)/Atmel/AtmelWiresharkFirmware/

### 3.2.3 Sniffer FW Installation

How to install the WireShark sniffer FW.

1. Download the Atmel WireShark Interface installer as described in "[Sniffer Interface Installation](#)" on page 16 .
2. Program the USB stick using the bootloader or the JTAGICE as described in "[Programming](#)" on page 3. The firmware files is located in C:/Program Files (x86)/Atmel/AtmelWiresharkFirmware/

### 3.3 Program Use

How to get started..

1. Insert the USB stick in the computer.
2. Start the Wireshark Interface program from the Atmel program folder
3. Select the COM port allocated to the USBstick with the sniffer FW and click Open.

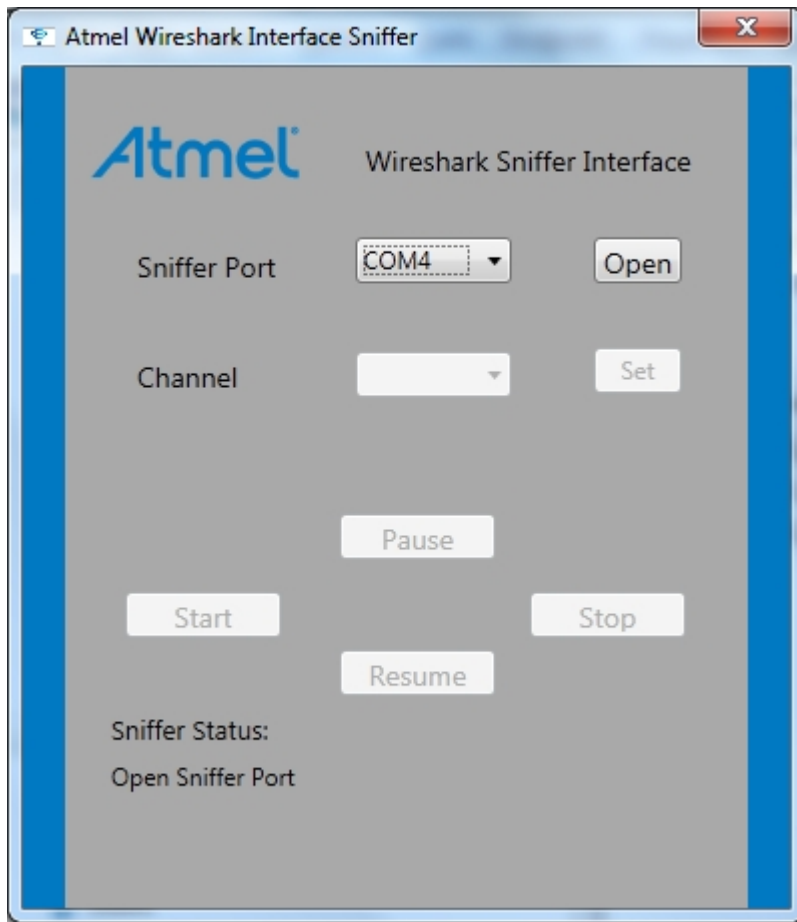

4. Select the Channel you want to monitor and click Set.

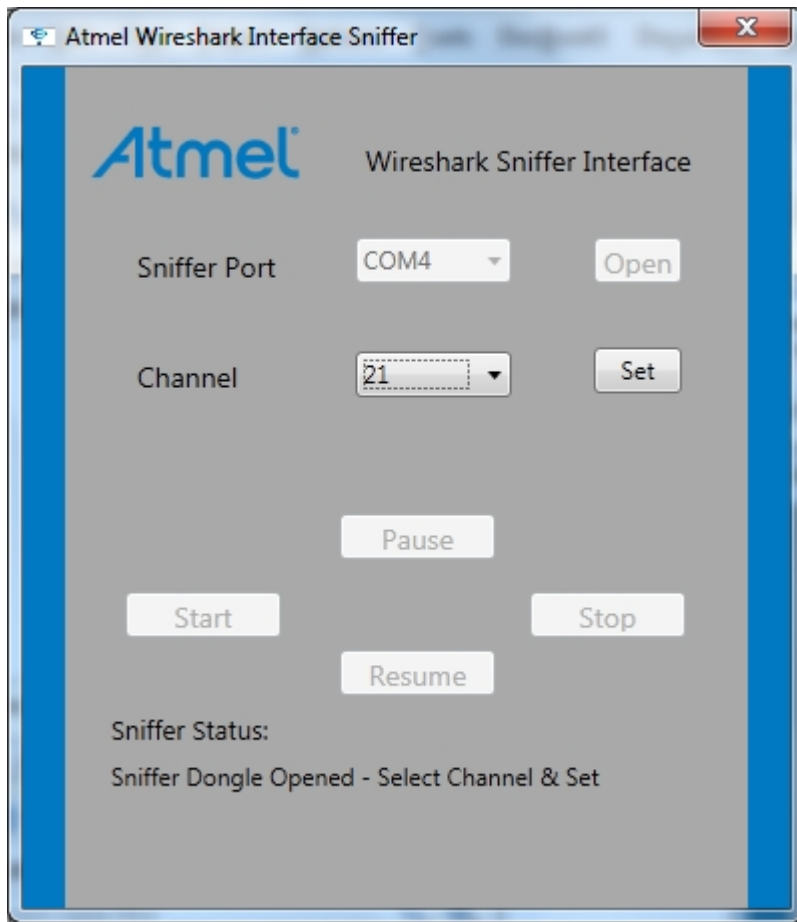

5. Click Start and WireShark is started.

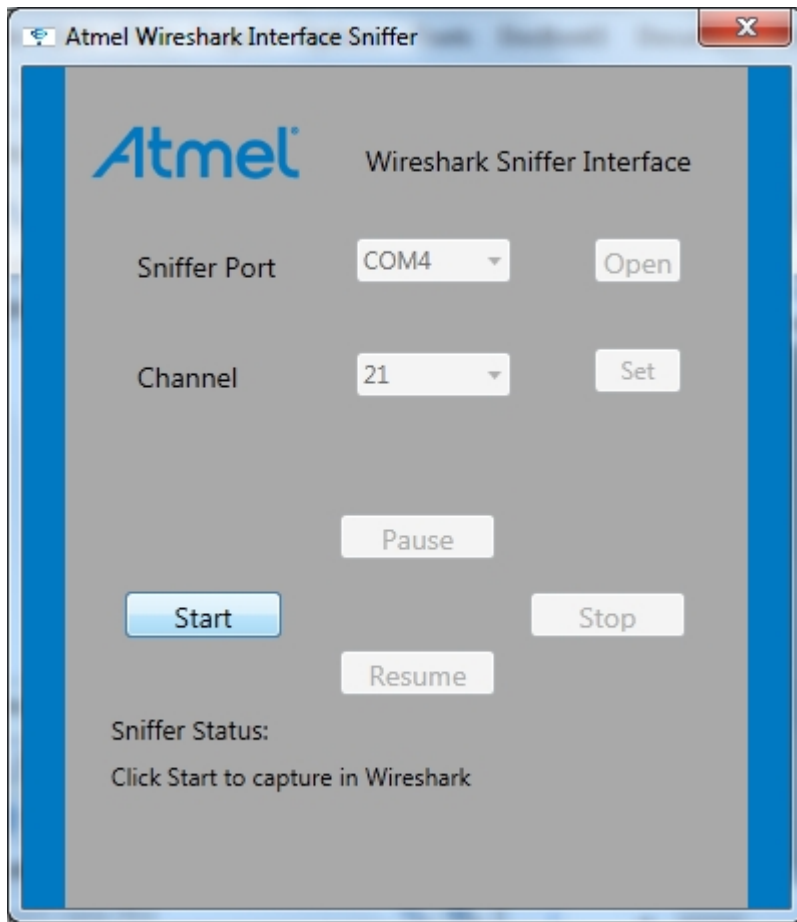

6. Select the protocol to Analyze in WireShark in order to get the protocol details decoded and displayed.

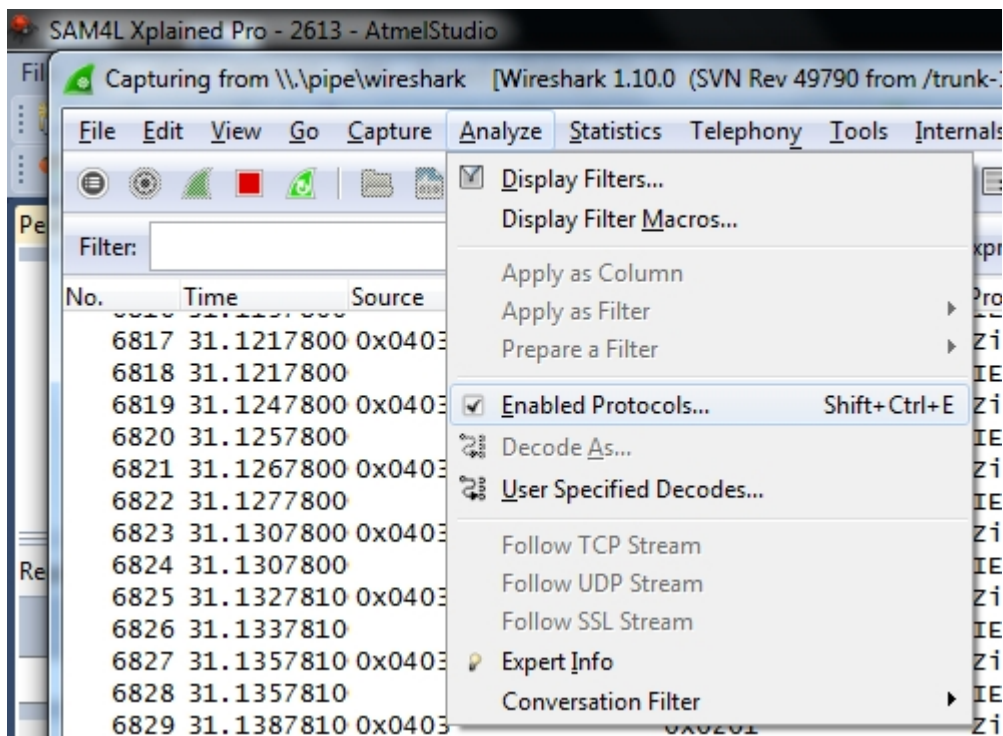

Disable all and select the applicable protocol.

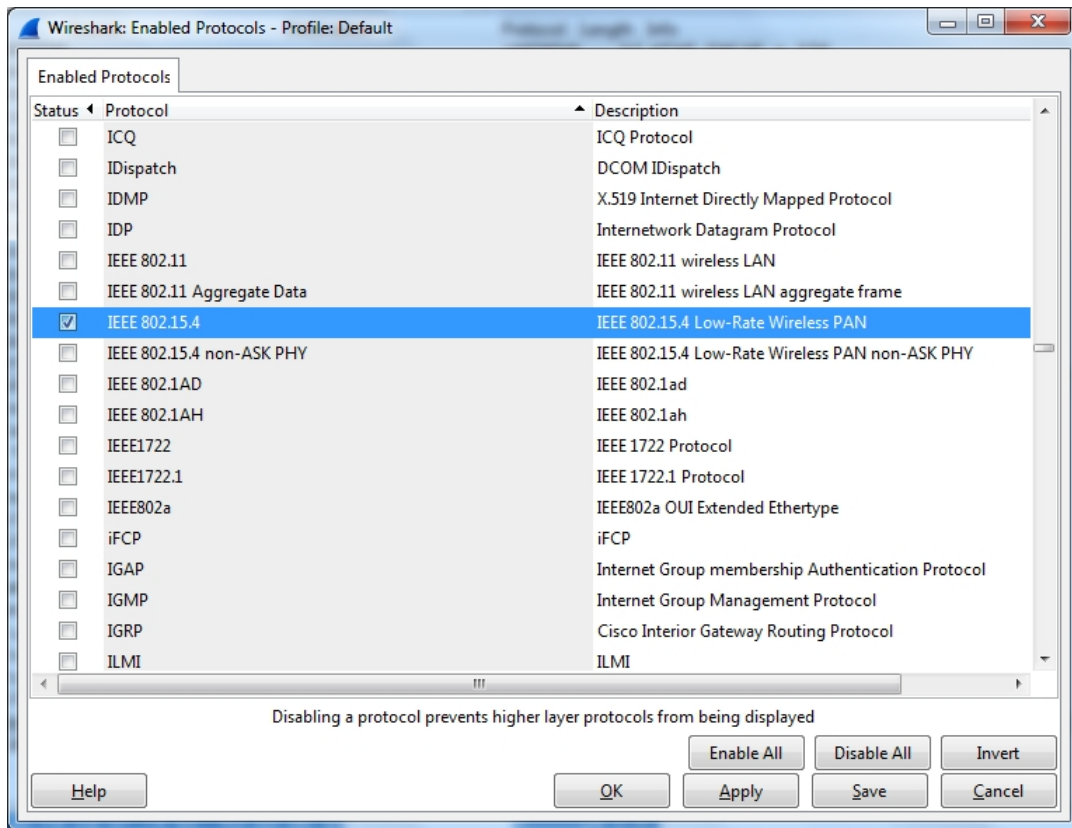

7. You can now monitor captured frames.

## 4. Hardware User Guide

### 4.1 Board Overview

Figure 4-1. Extension Assembly.jpg

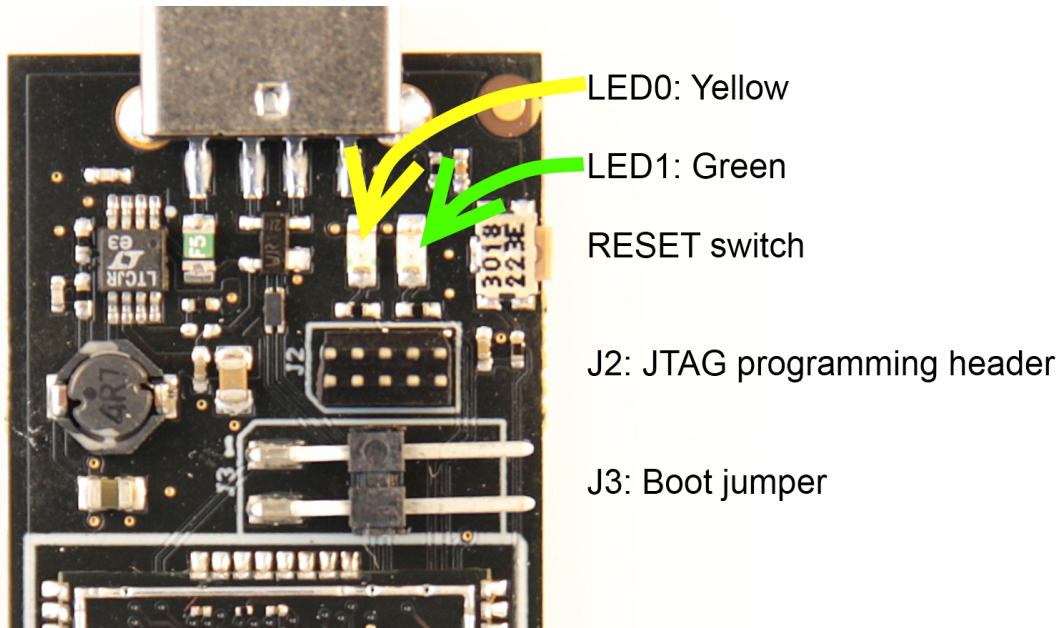
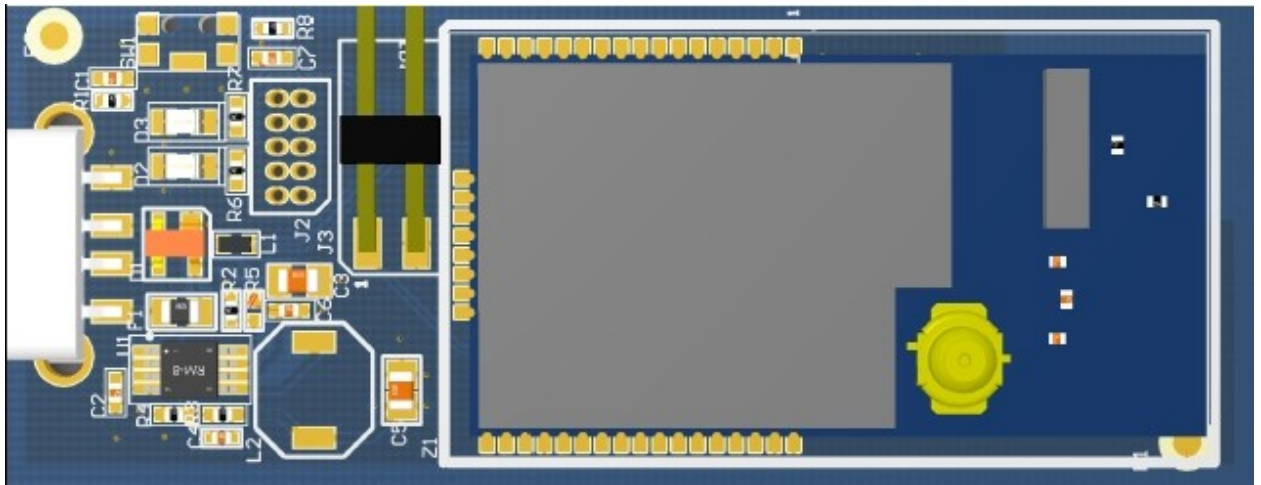

### 4.2 Headers and Connectors

The extension board connectors.

#### 4.2.1 JTAG (J2)

J2 is the JTAG programming header typically used by the JTAGICE.

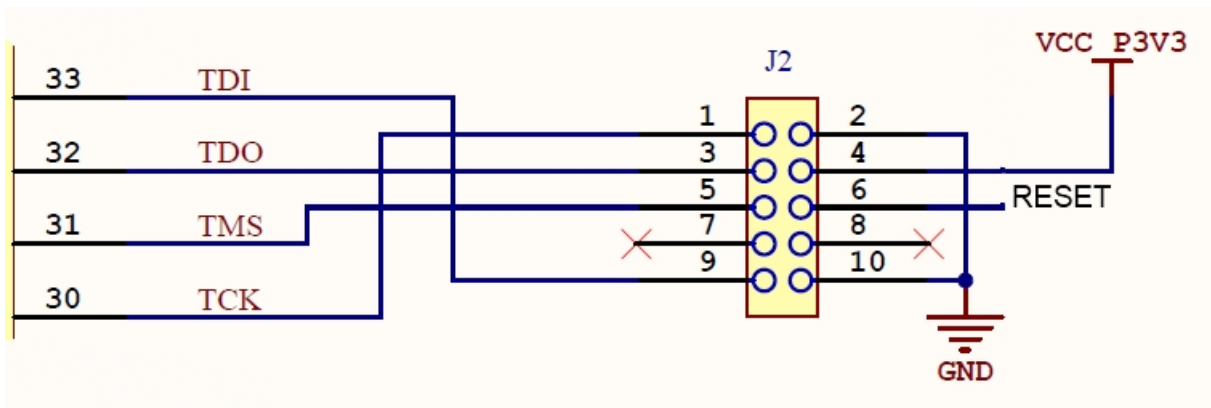

#### 4.2.2 Boot Select (J3)

J3 enables the Bootloader when J3.1 connected to GND during RESET.

Insert jumper on J3 to connect J3.1 to J3.2.

**Table 4-1. J5 Current measurement**

J3 pin	ZigBit pin	XMEGA® pin	Function
1	38	41-PE5	Bootloader enable
2	GND	GND	GND

### 4.3 Board GUI

#### 4.3.1 LED's

There are two LEDs available for use by application SW.

**Table 4-2. LED's**

	LED	ZigBit pin	XMEGA pin
D2	LED0 - Yellow	10	3 - PA5
D3	LED1 - Green	11	2 - PA4

#### 4.3.2 Button

There is one switch for RESET of the micro-controller.

**Table 4-3. Buttons**

Button	Function	ZigBit pin	XMEGA pin
SW1	ZigBit Reset, press to reset	5	56 - RESET

### 4.4 Factory Programmed Data

The ZigBit® has a preprogrammed unique MAC address - details available in the ZigBit data sheet and in ["Persistence Memory" on page 24](#).

The USB stick comes with a Bootloader and the Performance Analyzer preprogrammed.

## 5. Persistence Memory

A dedicated memory space is allocated to store product specific information and called the Persistence Memory. The organization of the persistence memory is as follows:

**Table 5-1. Persistence Memory**

Data	Size
Structure Revision	2 bytes
MAC address	8 bytes
Board information – PCBA Name	30 bytes
Board information – PCBA Serial number	10 bytes
Board information – PCBA Atmel Part Number	8 bytes
Board information – PCBA Revision	1 byte
XTAL Calibration Value	1 byte
Reserved	7 bytes
Reserved	4 bytes
CRC	1 bytes

The MAC address stored inside the MCU is a uniquely assigned ID for each ZigBit® and owned by Atmel. User of the ZigBit application can use this unique MAC ID to address the ZigBit in end-applications. The MAC ID can be read from the ZigBit using the Performance Analyzer Application that is supplied through Atmel Studio Gallery Extension.



## 6. Document Revision History

Document revision	Date	Comment
42194A	10/2013	Initial document release



**Atmel Corporation** 1600 Technology Drive, San Jose, CA 95110 USA    **T:** (+1)(408) 441.0311    **F:** (+1)(408) 436.4200    |    [www.atmel.com](http://www.atmel.com)

© 2013 Atmel Corporation. All rights reserved. / Rev.: 42194A-MCU-11/2013

Atmel®, Atmel logo and combinations thereof, Enabling Unlimited Possibilities®, ZigBit®, XMEGA®, AVR®, and others are registered trademarks or trademarks of Atmel Corporation or its subsidiaries. Other terms and product names may be trademarks of others.

Disclaimer: The information in this document is provided in connection with Atmel products. No license, express or implied, by estoppel or otherwise, to any intellectual property right is granted by this document or in connection with the sale of Atmel products. EXCEPT AS SET FORTH IN THE ATMEL TERMS AND CONDITIONS OF SALES LOCATED ON THE ATMEL WEBSITE, ATMEL ASSUMES NO LIABILITY WHATSOEVER AND DISCLAIMS ANY EXPRESS, IMPLIED OR STATUTORY WARRANTY RELATING TO ITS PRODUCTS INCLUDING, BUT NOT LIMITED TO, THE IMPLIED WARRANTY OF MERCHANTABILITY, FITNESS FOR A PARTICULAR PURPOSE, OR NON-INFRINGEMENT. IN NO EVENT SHALL ATMEL BE LIABLE FOR ANY DIRECT, INDIRECT, CONSEQUENTIAL, PUNITIVE, SPECIAL OR INCIDENTAL DAMAGES (INCLUDING, WITHOUT LIMITATION, DAMAGES FOR LOSS AND PROFITS, BUSINESS INTERRUPTION, OR LOSS OF INFORMATION) ARISING OUT OF THE USE OR INABILITY TO USE THIS DOCUMENT, EVEN IF ATMEL HAS BEEN ADVISED OF THE POSSIBILITY OF SUCH DAMAGES. Atmel makes no representations or warranties with respect to the accuracy or completeness of the contents of this document and reserves the right to make changes to specifications and products descriptions at any time without notice. Atmel does not make any commitment to update the information contained herein. Unless specifically provided otherwise, Atmel products are not suitable for, and shall not be used in, automotive applications. Atmel products are not intended, authorized, or warranted for use as components in applications intended to support or sustain life.

# Mouser Electronics

Authorized Distributor

Click to View Pricing, Inventory, Delivery & Lifecycle Information:

[Microchip:](#)

[ATZB-X-233-USB](#) [ATZB-X-212B-USB](#)

Компания «Океан Электроники» предлагает заключение долгосрочных отношений при поставках импортных электронных компонентов на взаимовыгодных условиях!

Наши преимущества:

- Поставка оригинальных импортных электронных компонентов напрямую с производств Америки, Европы и Азии, а так же с крупнейших складов мира;
- Широкая линейка поставок активных и пассивных импортных электронных компонентов (более 30 млн. наименований);
- Поставка сложных, дефицитных, либо снятых с производства позиций;
- Оперативные сроки поставки под заказ (от 5 рабочих дней);
- Экспресс доставка в любую точку России;
- Помощь Конструкторского Отдела и консультации квалифицированных инженеров;
- Техническая поддержка проекта, помощь в подборе аналогов, поставка прототипов;
- Поставка электронных компонентов под контролем ВП;
- Система менеджмента качества сертифицирована по Международному стандарту ISO 9001;
- При необходимости вся продукция военного и аэрокосмического назначения проходит испытания и сертификацию в лаборатории (по согласованию с заказчиком);
- Поставка специализированных компонентов военного и аэрокосмического уровня качества (Xilinx, Altera, Analog Devices, Intersil, Interpoint, Microsemi, Actel, Aeroflex, Peregrine, VPT, Syfer, Eurofarad, Texas Instruments, MS Kennedy, Miteq, Cobham, E2V, MA-COM, Hittite, Mini-Circuits, General Dynamics и др.);

Компания «Океан Электроники» является официальным дистрибьютором и эксклюзивным представителем в России одного из крупнейших производителей разъемов военного и аэрокосмического назначения «JONHON», а так же официальным дистрибьютором и эксклюзивным представителем в России производителя высокотехнологичных и надежных решений для передачи СВЧ сигналов «FORSTAR».



## JONHON

«JONHON» (основан в 1970 г.)

Разъемы специального, военного и аэрокосмического назначения:

(Применяются в военной, авиационной, аэрокосмической, морской, железнодорожной, горно- и нефтедобывающей отраслях промышленности)

«FORSTAR» (основан в 1998 г.)

ВЧ соединители, коаксиальные кабели, кабельные сборки и микроволновые компоненты:

(Применяются в телекоммуникациях гражданского и специального назначения, в средствах связи, РЛС, а так же военной, авиационной и аэрокосмической отраслях промышленности).



Телефон: 8 (812) 309-75-97 (многоканальный)

Факс: 8 (812) 320-03-32

Электронная почта: [ocean@oceanchips.ru](mailto:ocean@oceanchips.ru)

Web: <http://oceanchips.ru/>

Адрес: 198099, г. Санкт-Петербург, ул. Калинина, д. 2, корп. 4, лит. А